

Board Layout

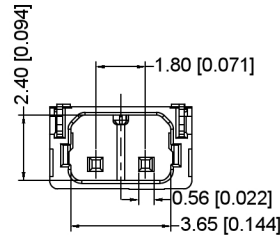

Specificationsxxb

规格:

Voltage rating:350V AC/DC

额定电压: 350V AC/DC

Current rating:4A AC/DC

额定电流: 4A AC/DC

Withstanding voltage:1700V AC/minute

耐受电压: 1700V AC/分钟

Temperature range:-25℃+85℃

温度范围: -25℃+85℃

Insulation resistance:≥1000MΩ

绝缘电阻: ≥1000MΩ

Contact resistance:≤30mΩ

接触电阻: ≤30mΩ XKB

After environmental testing:≤20mΩ

环境测试后: ≤20兆欧

X1800 WRS-02A-LP SW

- ⊙Series No.
- ⊙Category:W-WAFER
- ⊙Welding Board Angle: R-Right Angle 90
- ⊙Welding Way:S-SMT
- ⊙Row No.-Pin No.: 02-02P
- ⊙Plug the Pin &Special No.: A- NO Lock
- ⊙Material:L-P-LCP 94V-0
- ⊙Plating Category: SW-Matte Tin Plating

X1800WRS-02A-LP5W	LCP UL 94V-0	Brass	Matte Tin	X1800H-A
PART NO	Material	Material(Pin)	Finish(Pin)	Suitable XKB Terminal

广东星坤科技股份有限公司

生 日期

文件工程章

REVISIONS	DATE	REVISED	APPROVED	UNSPECIFIED TOLERANCES

DSND	DATE	SCALE: N/A	MODEL TYPE: X1800WRS-02A-LP5W
DWVN	DATE	VIEW: ①	PART NO.: 2.54 mm Crimp Style Connectors
CHKD	DATE	UNIT: mm/in	DWG NO.:
APPD	DATE	SIZE: A4	
XKB INDUSTRIAL PRECISION CO.,LIMITED			WEIGHT 1.0g SHEET 1/1 REVISION A0

Specificationsxxb

规格:

Voltage rating:350V AC/DC

额定电压: 350V AC/DC

Current rating:3.2A AC/DC

额定电流: 3.2A AC/DC

Withstanding voltage:1700V AC/minute

耐受电压: 1700V AC/分钟

Temperature range:-25°C~+85°C

温度范围: -25°C~+85°C

Insulation resistance:≥1000MΩ

绝缘电阻: ≥1000MΩ

Contact resistance:≤10mΩ

接触电阻: ≤10mΩ XKB

After environmental testing:≤20mΩ

环境测试后: ≤20兆欧

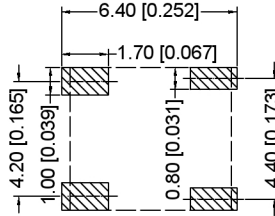
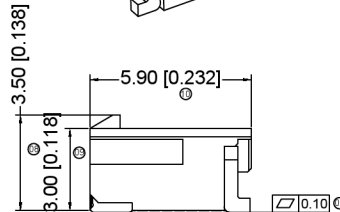
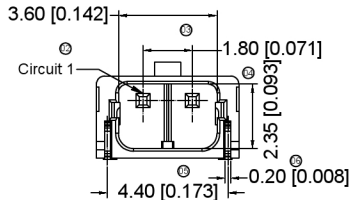
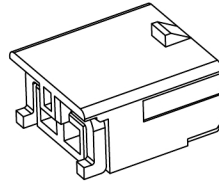
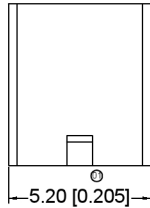

Recommended P.C.B Layout
General Tolerances:0.05

X1800 WRS-02 B-LP SW
① ② ③ ④ ⑤ ⑥ ⑦ ⑧

- ① Series No.
- ② Category:W-WAFER
- ③ Welding Board Angle: R-Right Angle 90°
- ④ Welding Way:S-SMT
- ⑤ Row No.-Pin No.: 02-02P
- ⑥ Plug the Pin &Special No.: A- With Lock
- ⑦ Material:LP-LCP 94V-0
- ⑧ Plating Category: SW-Matte Tin Plating

广东星坤科技股份有限公司

生 日期

文件工程章

REVISIONS
www.heloxkb.com

DATE	REVISED	APPROVED	XKB	ANGULAR	±5°
				L ≤ 4	±0.2
				4 < L ≤ 16	±0.3
				16 < L ≤ 63	±0.4
				L > 63	±0.5

UNSPECIFIED TOLERANCES

PART NO	Material	Material(Pin)	Finish(Pin.)	Suitable XKB Terminal
X1800WRS-02B-LP SW	LCP UL 94V-0	Brass	Matte Tin	X1800H-A

DSND	DATE	SCALE: NA	MODEL TYPE:
DWNN	DATE	VIEW:	X1800WRS-02B-LP SW
CHKD	DATE	UNIT: mm/in	PART NO.: 2.54 mm Crimp Style Connectors
APPD	DATE	SIZE: A4	DWG NO.:
XKB INDUSTRIAL PRECISION CO.,LIMITED			WEIGHT 1.0g
			SHEET 1/1
			REVISION A0

XKB

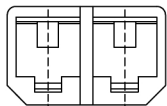
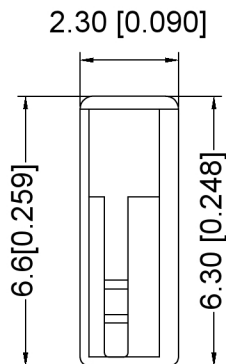
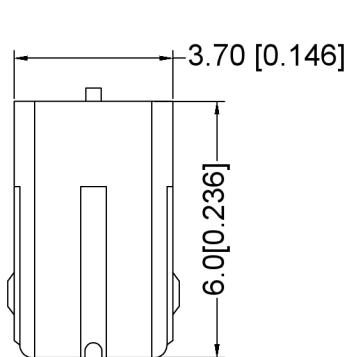
Specifications_{XKB}

规格:

Voltage rating:350V AC/DC

额定电压: 350V AC/DC

Current rating:4A AC/DC

额定电流: 4A AC/DC

Withstanding voltage:1700V AC/minute

耐受电压: 1700V AC/分钟

Temperature range:-25℃~+85℃

温度范围: -25℃~+85℃

Insulation resistance:≥1000MΩ

绝缘电阻: ≥1000MΩ

Contact resistance:≤30mΩ

接触电阻: ≤30mΩ _{XKB}

After environmental testing:≤20mΩ

环境测试后: ≤20兆欧

X1800 H X-02 A-N0

① ② ③ ④ ⑤ ⑥

① Series No.

② Category:H-HSG

③ Welding Board Angle: Blank-ordinary

④ Row No.-Pin No.: 02-02P

⑤ Plug the Pin &Special No.: A- No Lock

⑥ Material:NO-PA66 94V-0

X1800H-02A-N0	Nylon 66 UL 94V-0	X1800T	X1800W
PART NO	Material	Suitable XKB Terminal	Suitable XKB Terminal

广东星坤科技股份有限公司	
生	日期
发	
Δ	
文件工程章	

					XKB	ANGULAR	±5°
						L ≤ 4	±0.2
						4 < L ≤ 16	±0.3
						16 < L ≤ 63	±0.4
						L > 63	±0.5
UNSPECIFIED TOLERANCES							

DSND		DATE		SCALE: N/A	MODEL TYPE: X1800H-02A-N0		
DWVN		DATE		VIEW:	PART NO.: 2.54 mm Crimp Style Connectors		
CHKD		DATE		UNIT: mm/in	DWG NO.:		
APPD		DATE		SIZE: A4			
XKB INDUSTRIAL PRECISION CO., LIMITED					WEIGHT 1.0g	SHEET 1/1	REVISION A0

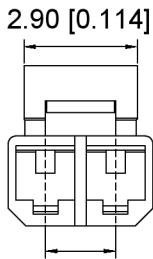
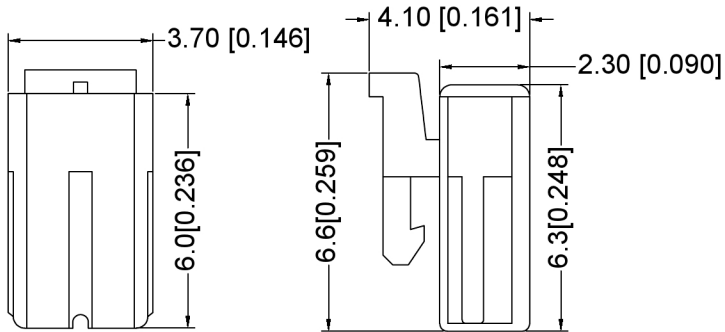

Specificationsxxb

规格:

Voltage rating:350V AC/DC

额定电压: 350V AC/DC

Current rating:4A AC/DC

额定电流: 4A AC/DC

Withstanding voltage:1700V AC/minute

耐受电压: 1700V AC/分钟

Temperature range:-25℃~+85℃

温度范围: -25℃~+85℃

Insulation resistance:≥1000MΩ

绝缘电阻: ≥1000MΩ

Contact resistance:≤30mΩ

接触电阻: ≤30mΩ XKB

After environmental testing:≤20mΩ

环境测试后: ≤20兆欧

X1800 H X-02 B-N0

- ①
- ②
- ③
- ④
- ⑤
- ⑥

① Series No.

② Category:H-HSG

③ Welding Board Angle: Blank-ordinary

④ Row No.-Pin No.: 02-02P

⑤ Plug the Pin &Special No.: A- With Lock

⑥ Material:NO-PA66 94V-0

1.80 [0.071]

广东星坤科技股份有限公司

生 日期

文件工程章

REVISIONS

DATE REVISED APPROVED

UNSPECIFIED TOLERANCES

www.heloxkb.com

XKB		XKB	
ANGLAR	±5°	ANGLAR	±5°
L ≤ 4	±0.2	4 < L ≤ 16	±0.3
16 < L ≤ 63	±0.4	L > 63	±0.5

X1800H-02B-N0	Nylon 66 UL 94V-0	X1800T	X1800W
PART NO	Material	Suitable XKB Terminal	Suitable XKB Terminal

DSND	DATE	SCALE: N/A	MODEL TYPE: X1800H-02B-N0
DWN	DATE	VIEW:	PART NO.: 2.54 mm Crimp Style Connectors
CHKD	DATE	UNIT: mm/mf	DWG NO.:
APPD	DATE	SIZE: A4	
XKB INDUSTRIAL PRECISION CO.,LIMITED			WEIGHT 1.0g
			SHEET 1/1
			REVISION A0

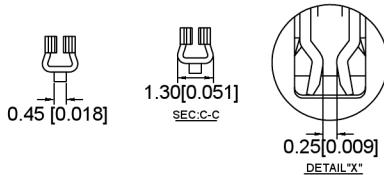
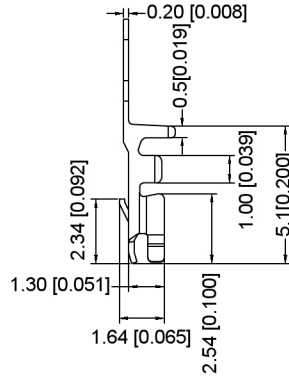
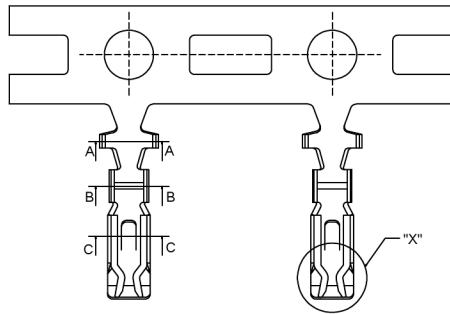

Specificationsxxb

规格:

Voltage rating:350V AC/DC

额定电压: 350V AC/DC

Current rating:4A AC/DC

额定电流: 4A AC/DC

Withstanding voltage:1700V AC/minute

耐受电压: 1700V AC/分钟

Temperature range:-25°C~+85°C

温度范围: -25°C~+85°C

Insulation resistance:≥1000MΩ

绝缘电阻: ≥1000MΩ

Contact resistance:≤30mΩ

接触电阻: ≤30mΩ XKB

After environmental testing:≤20mΩ

环境测试后: ≤20兆欧

X1800 T -PSN



⊙ Series Number

⊙ Category: T-terminal

⊙ Material: P-Phos phor bronze

⊙ Plating Style: SN-Bright tin plating

X1800T-PSN	Phosphor Bronze	AWG#28-30	1.8mm(Max)	Stamping Before plating 30u"MIN Ni;70u"Sn	X1800H
XPART NO	Material	Wire Range	Insulation O.D	Finish	Suitable XKB Terminal

广东星坤科技股份有限公司

生 日期

文件工程章

REVISIONS

DATE REVISED APPROVED

UNSPECIFIED TOLERANCES

www.helxkb.com

XKB	ANGLAR	±5°
	L ≤ 4	±0.2
	4 < L ≤ 16	±0.3
	16 < L ≤ 63	±0.4
	L > 63	±0.5

DSND	DATE	SCALE: N/A	MODEL TYPE: X1800T-PSN
DWN	DATE	VIEW:	PART NO.: 2.54 mm Crimp Style Connectors
CHKD	DATE	UNIT: mm/in	DWG NO.:
APPD	DATE	SIZE: A4	
XKB INDUSTRIAL PRECISION CO.,LIMITED			WEIGHT 1.0g SHEET 1/1 REVISION A0

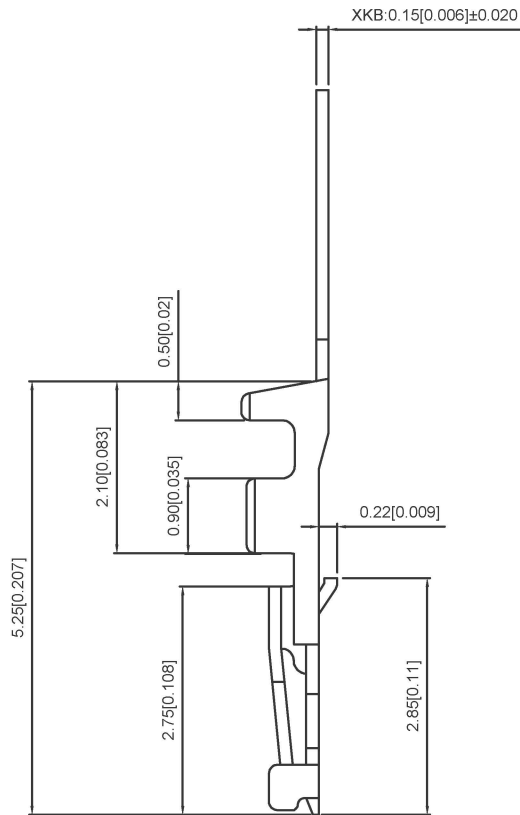
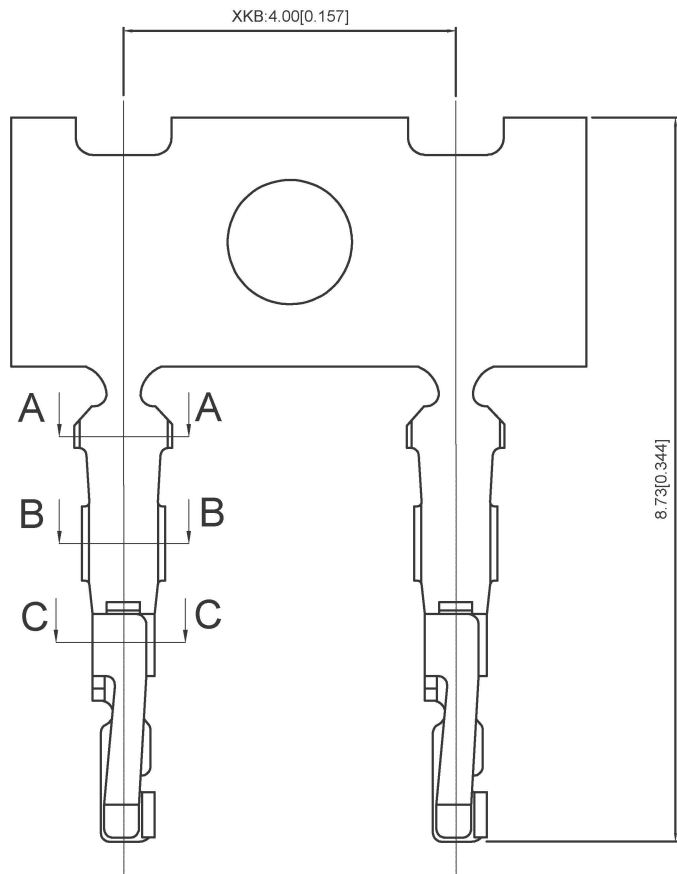

Specifications:
 规格:
 Voltage rating:100V AC/DC
 额定电压: 100V AC/DC
 Current rating:1A AC/DC
 额定电流: 1A AC/DC
 Withstanding voltage:500V AC/minute
 耐受电压: 500V AC/分钟
 Temperature range:-25°C-+85°C
 温度范围: -25°C-+85°C
 Insulation resistance:≥500MΩ
 绝缘电阻: ≥500MΩ
 Contact resistance:≤30mΩ
 接触电阻: ≤30mΩ
 After environmental testing:≤40mΩ
 环境测试后: ≤40兆欧

X1008 T X-PV01X-A
 ① ②③④⑤⑥⑦

- 1.Series Number
- 2.Category:T-terminal
- 3.Shape:Blank-ordinary
- 4.Material:P-Phosphor bronze
- 5.Plating style:V01-ALL Gold-Flash
- 6.Plating method:
Blank-Stamping before plating
- 7.Mold No/Mark/Special No:A-A Type

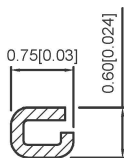
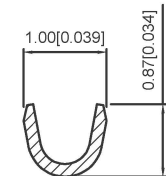
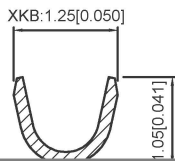

X1008T-PV01-A	Phosphor Bronze	AWG#28-32	0.60mm(Max)	Stamping Before Pating:30u Ni Whole Gold:Gold Flash	X1008H
PART NO	Material	Wire Range	Insulation OD	Suitable XKB Terminal	Suitable XKB Terminal

广东星坤科技股份有限公司

SECTION A-A
SCALE:1:1

SECTION B-B
SCALE:1:1

SECTION C-C
SCALE:1:1

生	日期								units: mm
ΔX									tolerance:
ΔX									X.X ±0.2mm
ΔX									X.XX ±0.1mm
MARK									X.XXX ±0.05mm
UNSPECIFIED TOLERANCES									

DSND		DATE		SCALE: N/A	MODEL TYPE:
DWN		DATE		VIEW:	PART NO.:
CHKD		DATE		UNIT: mm/in	1.00mm Crimp Style Connectors
APPD		DATE		SIZE: A4	DWG NO.:
XKB INDUSTRIAL PRECISION CO., LIMITED					X1008T-PV01-A
				WEIGHT	SHEET
				1.0g	1/1
					REVISION
					A0

文件工程章