

TEC Series

Wakefield-Vette's **Peltier, thermoelectric coolers** can meet the requirement of higher current and large cooling. It is often applied to experimental, scientific and biomedical instruments, laboratory equipment, industry and electrical equipment and consumables. The ambient temperature can arrive 100C, long-term working temperature is recommended to be below 90C.



Features:

- All products are RoHS and REACH compliant, SGS ISO9001 verified
- Thermoelectric module material are UL certification
- Standard Wire is 150mm
- Thermoelectric module moisture protection standard is sealed by white RTV silicone, but also support select other moisture protection style, Such as translucent silicone, black epoxy.
- Thermoelectric module flatness tolerance support select 0.2mm, 0.13mm, 0.1mm.

WKV Part Number	Description	Current max (A)	Q max (W) @ 27°C	V max (V) @ 27°C	ΔT max (°C) @ 27°C	# of Couples	Outline (L/W/)	Height (mm)
TEC-30-40-127	PELTIER TEC 30X30 4MM 2.5A	2.5	21.4	15.4	68	127	30x30	4
TEC-30-32-127	PELTIER TEC 30X30 3.2MM 3.9A	3.9	33.4	15.4	68	127	30x30	3.2
TEC-40-39-127	PELTIER TEC 40X40 4.7MM 3.9A	3.9	33.4	15.4	68	127	40x40	3.9
TEC-40-33-127	PELTIER TEC 40X40 3.3MM 8.5A	8.5	72	15.4	68	127	40x40	3.3
TEC-30-36-127	PELTIER TEC 30X30 3.6MM 3.0A	3.0	25.7	15.4	68	127	30x30	3.6
TEC-30-39-71	PELTIER TEC 30X30 4.7MM 3.9A	3.9	18.7	8.6	68	71	30x30	3.9
TEC-30-36-71	PELTIER TEC 30X30 3.8MM 6.0A	6.0	28.7	8.6	68	71	30x30	3.6
TEC-40-36-127	PELTIER TEC 40X40 3.8MM 6.0A	6.0	51.4	15.4	68	127	40x40	3.6
TEC-20-33-31	PELTIER TEC 20X20 3.3MM 8.5A	8.5	16.8	3.75	68	31	20x20	3.3
TEC-30-33-71	PELTIER TEC 30X30 3.3MM 8.5A	8.5	72	15.4	68	71	30x30	3.3

Thermoelectric Cooler Performance Specifications



TEC-40-39-127

Hot Side Temperature(°C)	27 °C	50 °C
Qmax (Watts)	33.4	39
Delta Tmax(°C)	68	75
I _{max} (Amps)	4.0	4.0
V _{max} (Volts)	15.4	16.4
Module Resistance(Ohms)	3.22	3.63

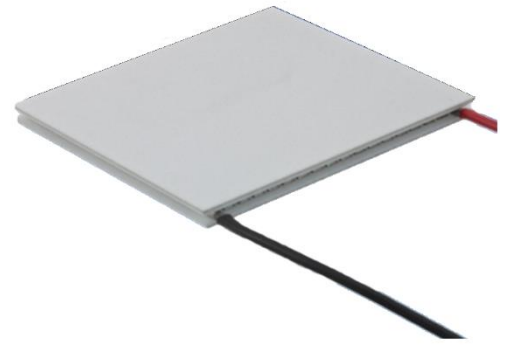

**Tolerances for thermal and electrical parameters ± 10%.

Performance Curves Th=25 °C

Performance Curves Th=50 °C

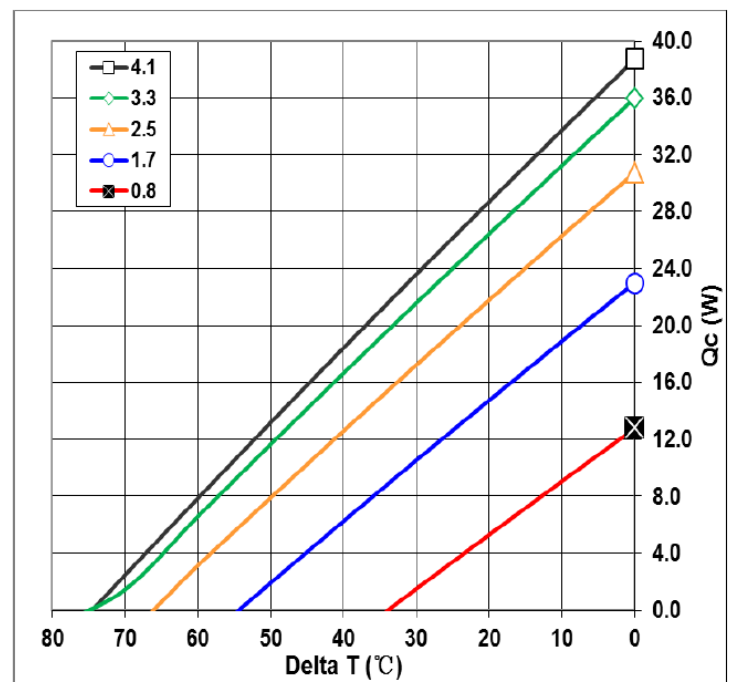
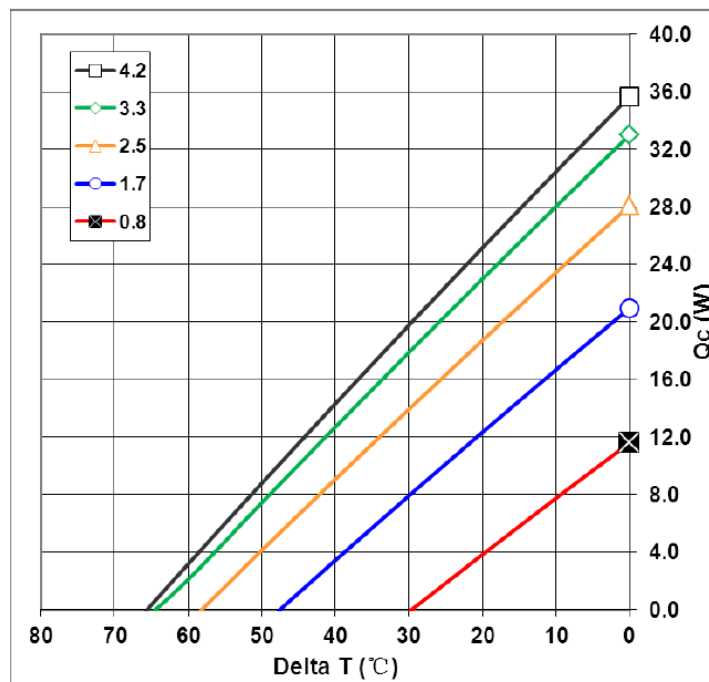
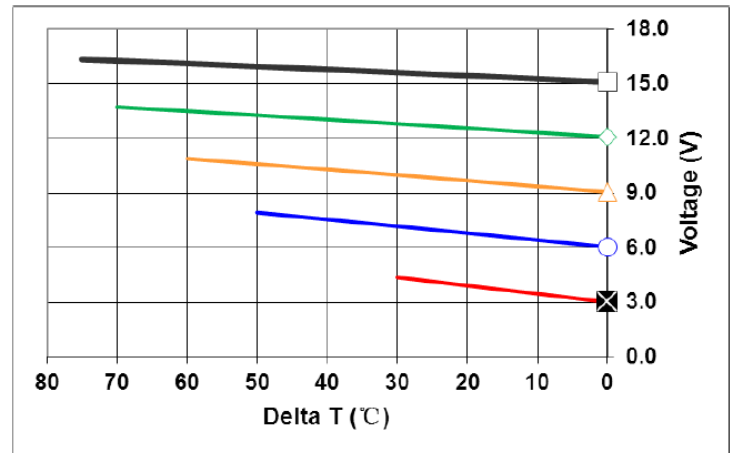
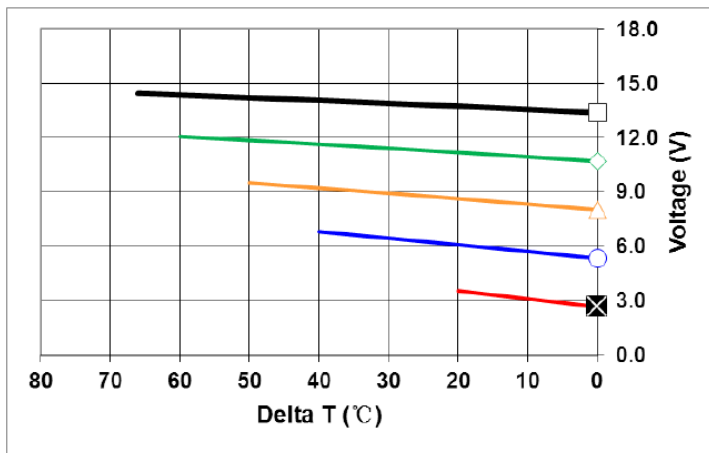

Mechanical Drawing:

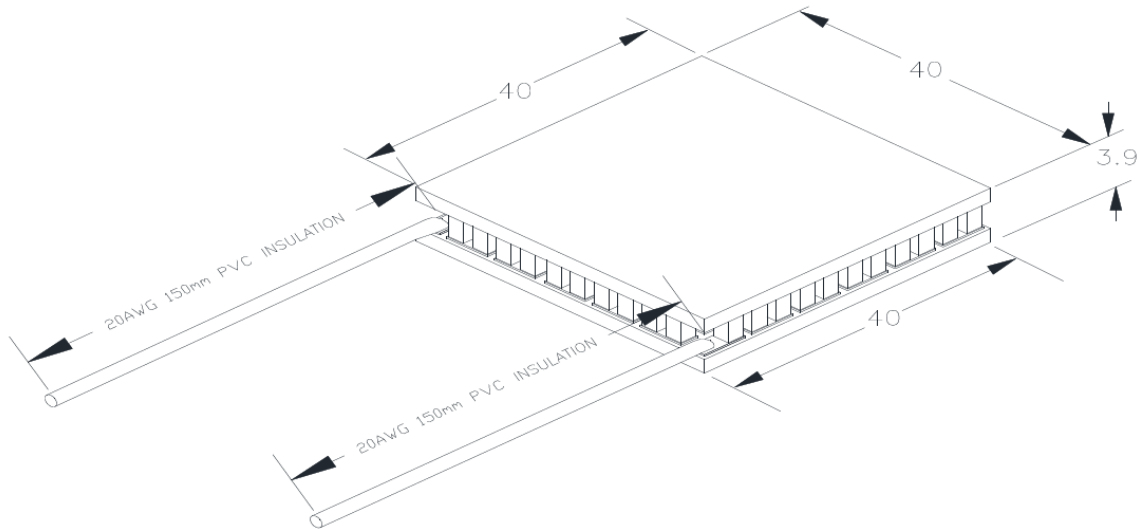

Operation Tips:

- **Maximum Operating Temperature: 90°C**
- **Do not exceed I_{max} or V_{max} when operating module**
- **Please consult Wakefield-Vette for moisture and corrosion protection options as well as specific application inquiries**

Thermoelectric Cooler Performance Specifications



TEC-30-32-127

Hot Side Temperature(°C)	27 °C	50 °C
Qmax (Watts)	33.4	36.6
Delta Tmax(°C)	68	75
I _{max} (Amps)	4.0	4.0
V _{max} (Volts)	15.4	16.4
Module Resistance(Ohms)	3.38	3.8

**Tolerances for thermal and electrical parameters ± 10%.

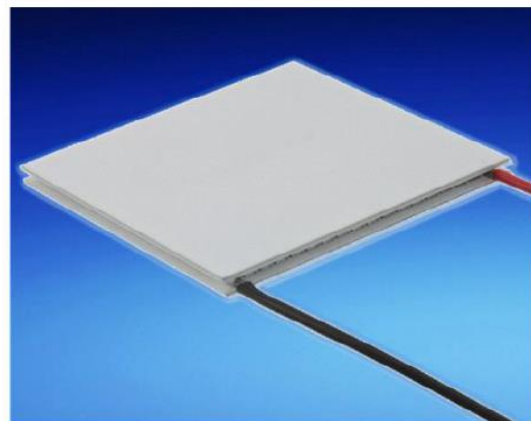

Performance Curves Th=25 °C

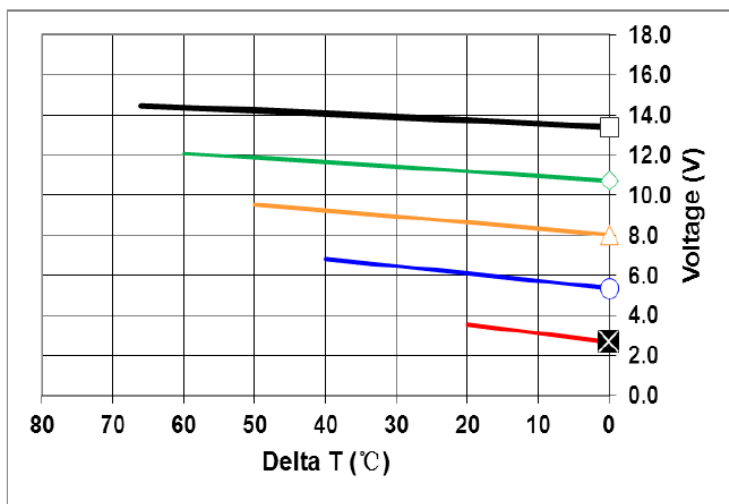

Performance Curves Th=50 °C

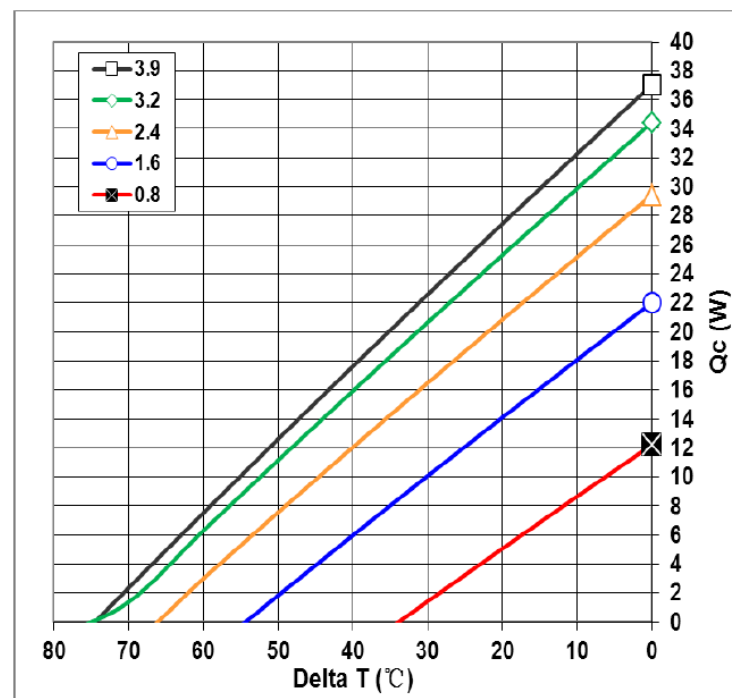
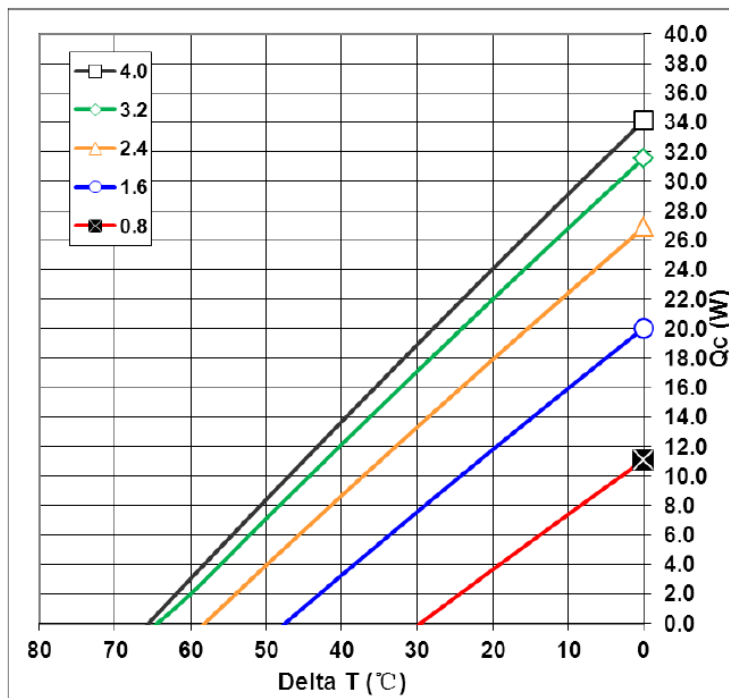
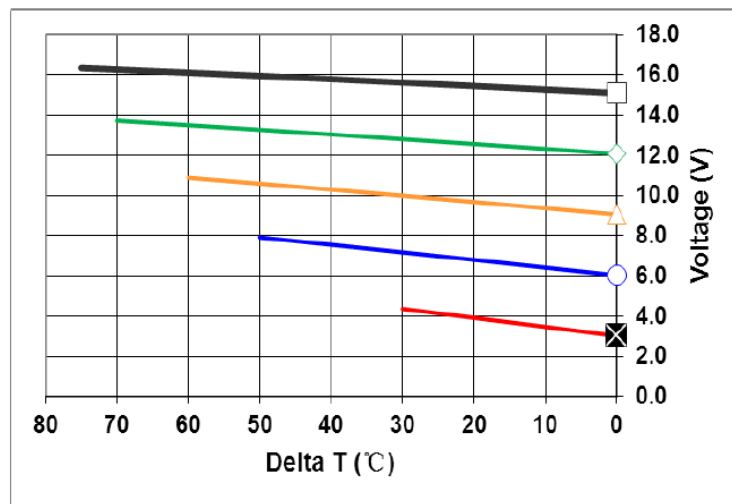

Wakefield-Vette reserves the right to change these specifications without notice

Mechanical Drawing:

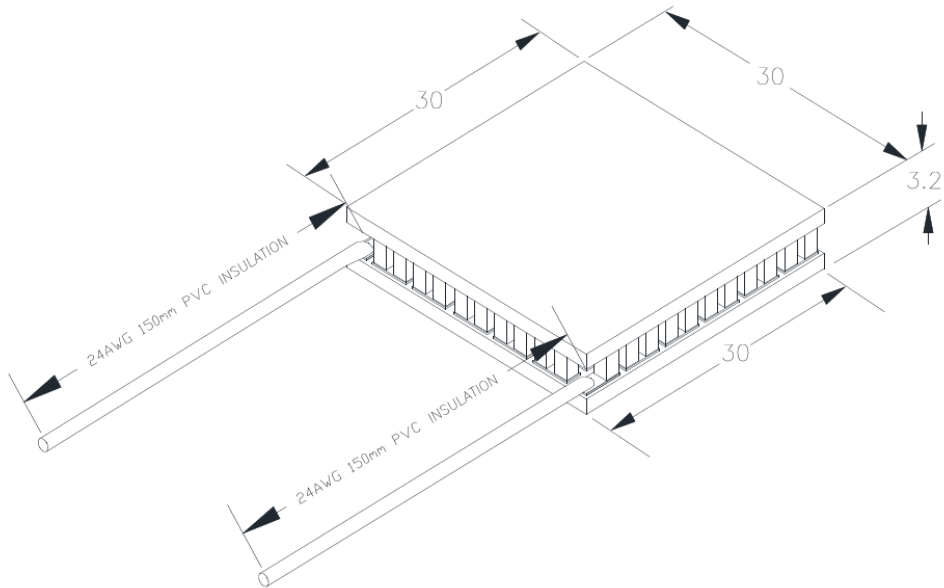

Operation Tips:

- **Maximum Operating Temperature: 90°C**
- **Do not exceed I_{max} or V_{max} when operating module**
- **Please consult Wakefield-Vette for moisture and corrosion protection options as well as specific application inquiries**

Thermoelectric Cooler Performance Specifications



TEC-30-40-127

Hot Side Temperature(°C)	27 °C	50 °C
Qmax (Watts)	21.4	23.6
Delta Tmax(°C)	68	75
I _{max} (Amps)	2.5	2.5
V _{max} (Volts)	15.4	16.4
Module Resistance(Ohms)	5.30	6.07

**Tolerances for thermal and electrical parameters ± 10%.

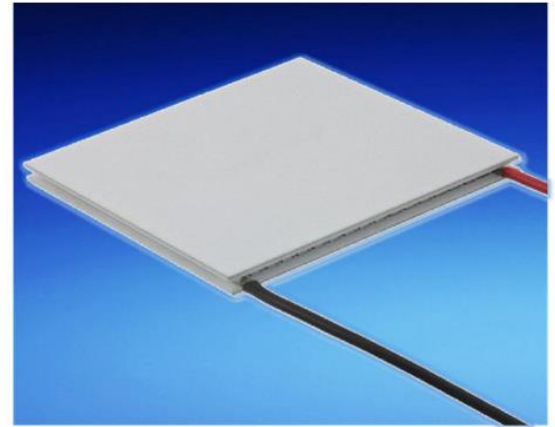

Performance Curves Th=25 °C

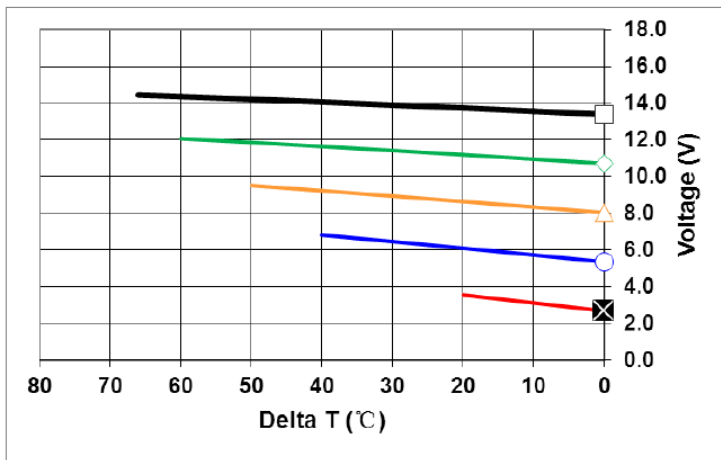

Performance Curves Th=50 °C

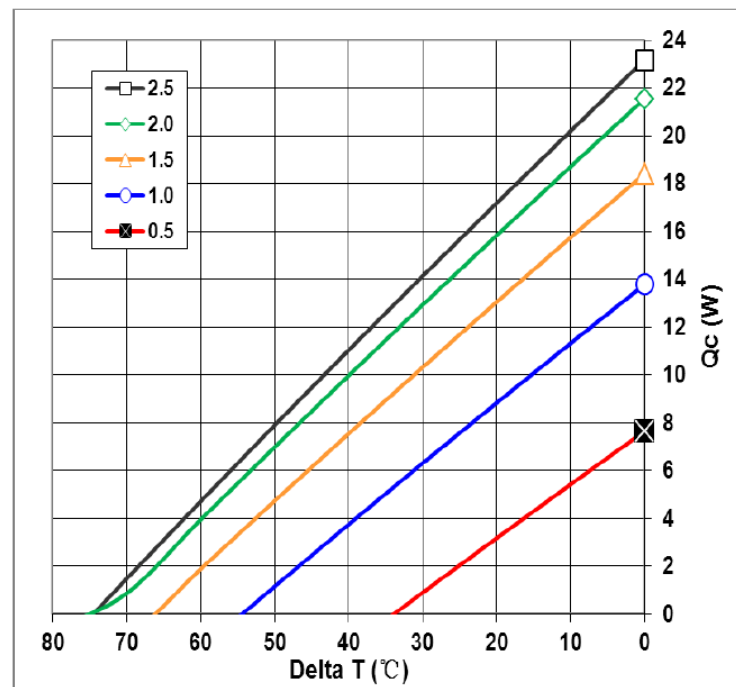
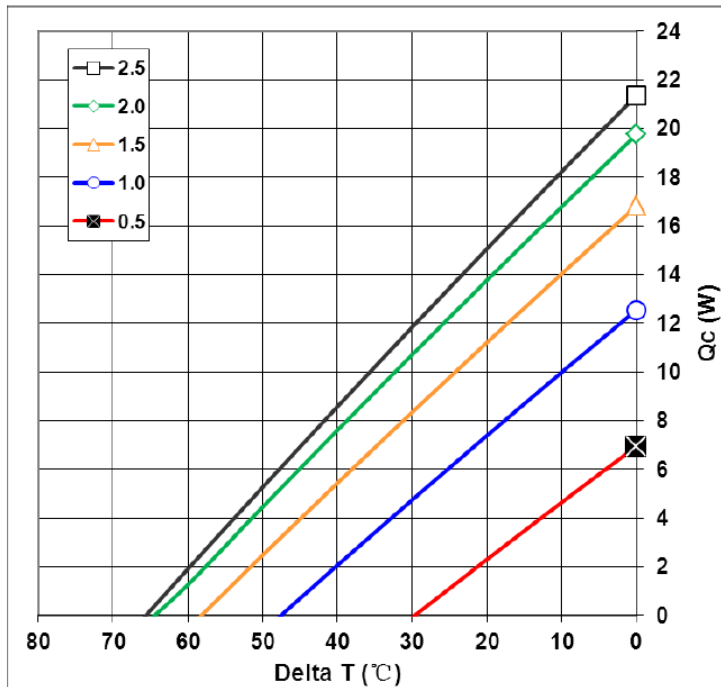
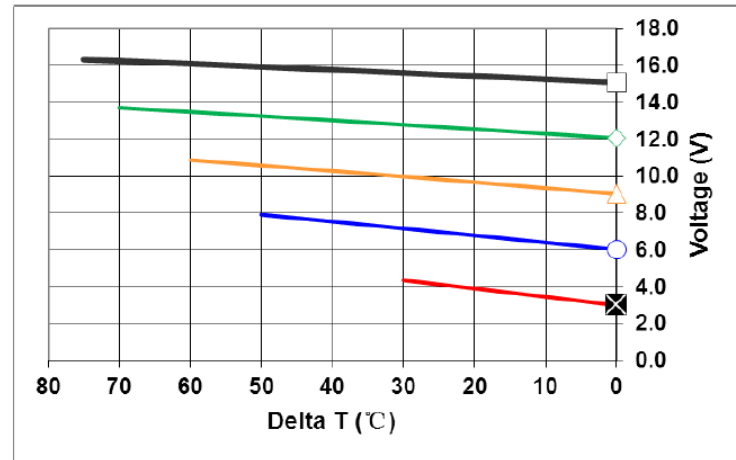

Mechanical Drawing:

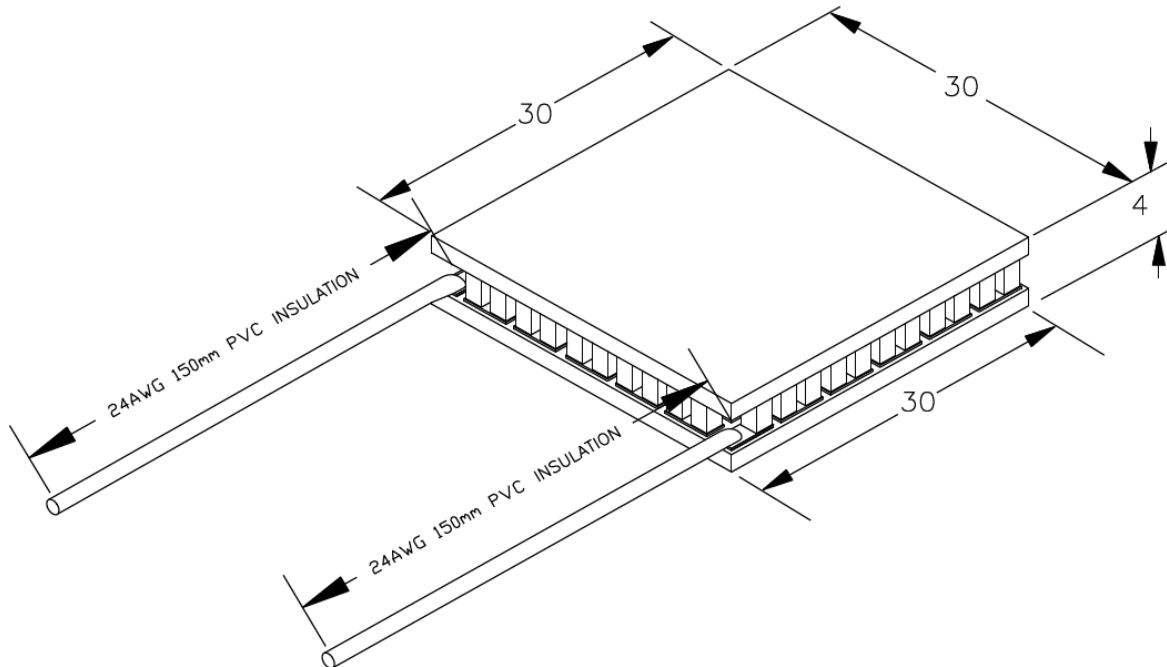

Operation Tips:

- **Maximum Operating Temperature: 90°C**
- **Do not exceed I_{max} or V_{max} when operating module**
- **Please consult Wakefield-Vette for moisture and corrosion protection options as well as specific application inquiries**

Thermoelectric Cooler Performance Specifications



TEC-40-33-127

Hot Side Temperature(°C)	27 °C	50 °C
Qmax (Watts)	72	82
Delta Tmax(°C)	68	75
I _{max} (Amps)	8.5	8.5
V _{max} (Volts)	15.4	16.4
ModuleResistance(Ohms)	1.66	1.74

**Tolerances for thermal and electrical parameters ± 10%.

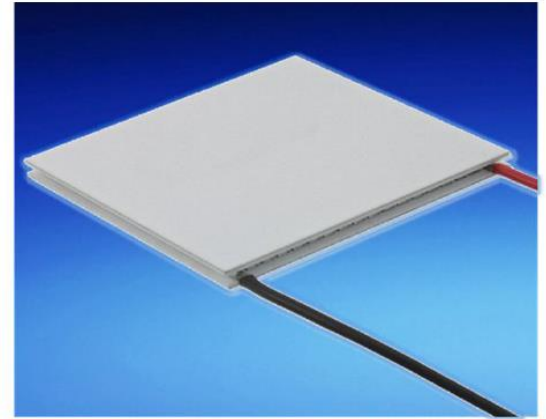

Performance Curves Th=25 °C

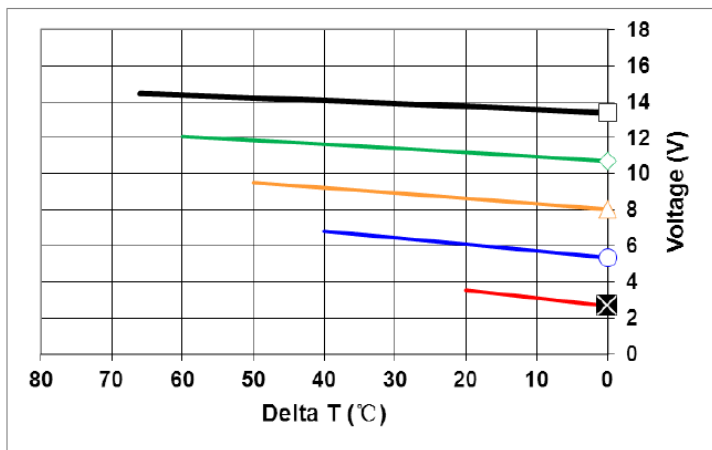

Performance Curves Th=50 °C

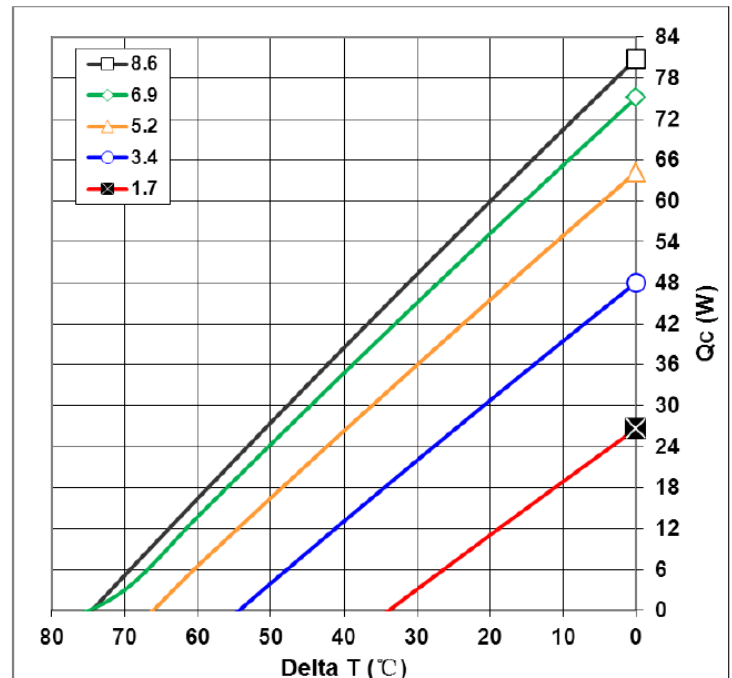
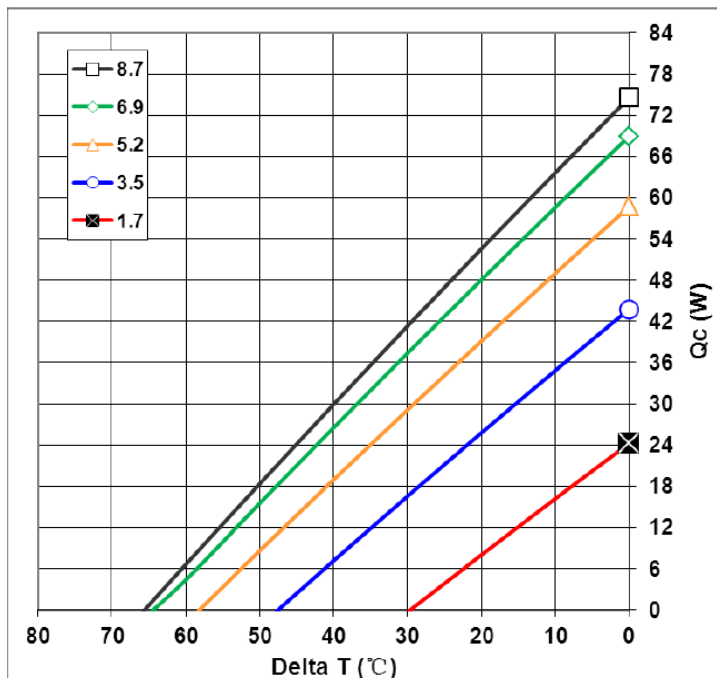
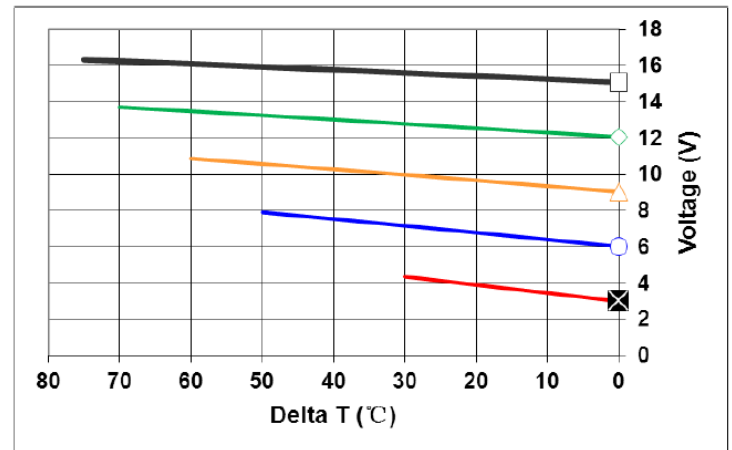

Mechanical Drawing:

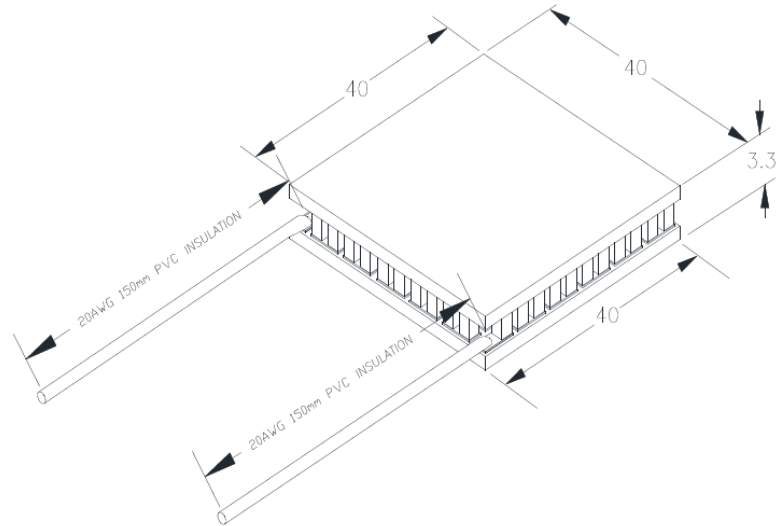

Operation Tips:

- **Maximum Operating Temperature: 90°C**
- **Do not exceed I_{max} or V_{max} when operating module**
- **Please consult Wakefield-Vette for moisture and corrosion protection options as well as specific application inquiries**

Thermoelectric Cooler Performance Specifications



TEC-30-36-127

Hot Side Temperature(°C)	27 °C	50 °C
Qmax (Watts)	25.7	29.8
Delta Tmax(°C)	68	75
I _{max} (Amps)	3.0	3.0
V _{max} (Volts)	15.4	16.4
Module Resistance(Ohms)	4.13	4.69

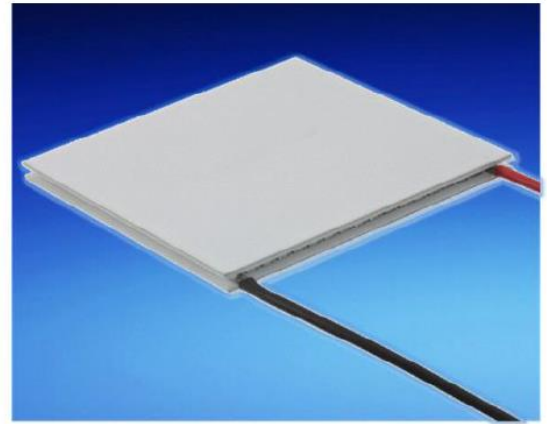

**Tolerances for thermal and electrical parameters ± 10%.

Performance Curves Th=25 °C

Performance Curves Th=50 °C

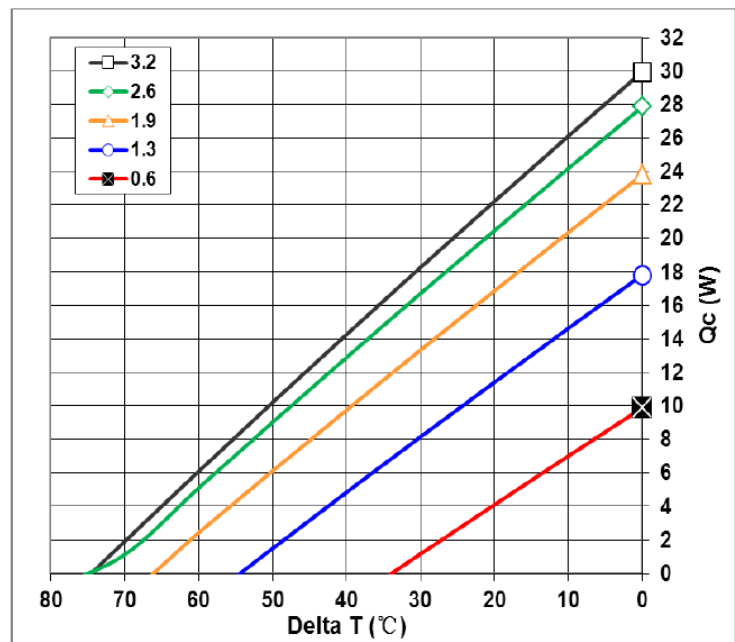
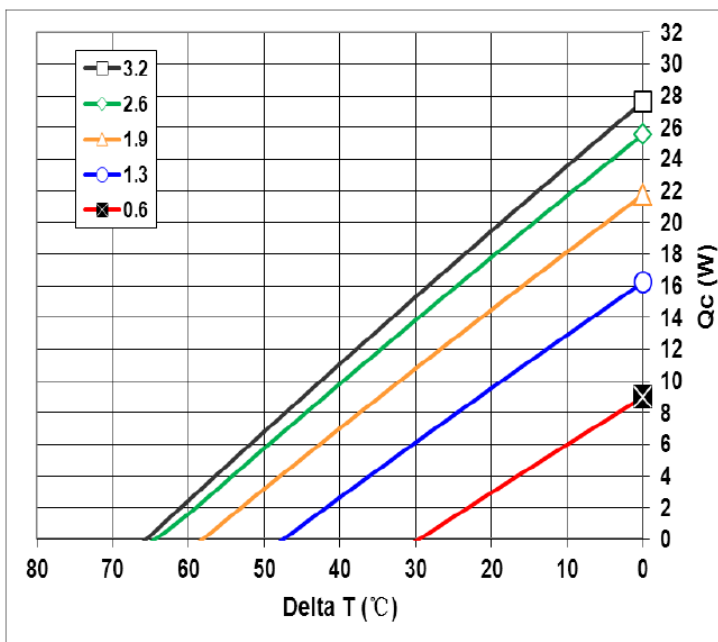
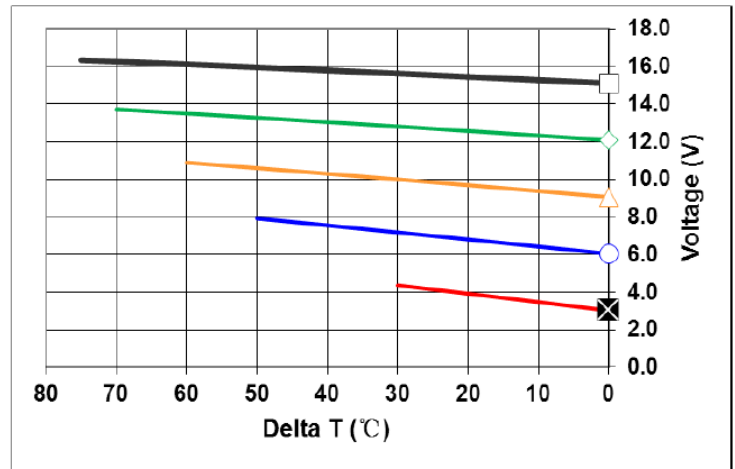
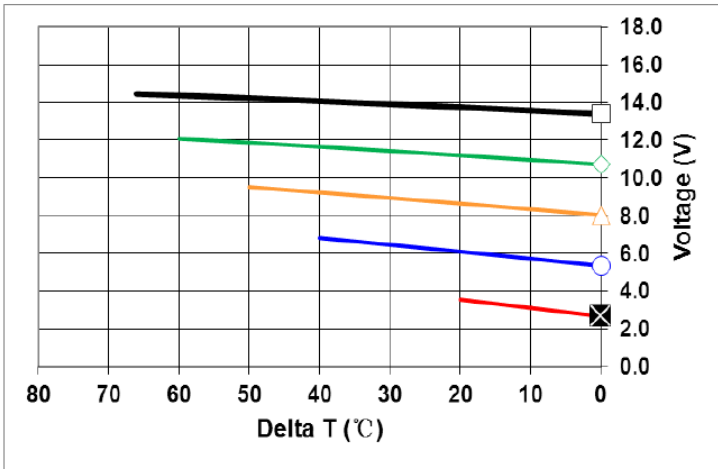

Mechanical Drawing:

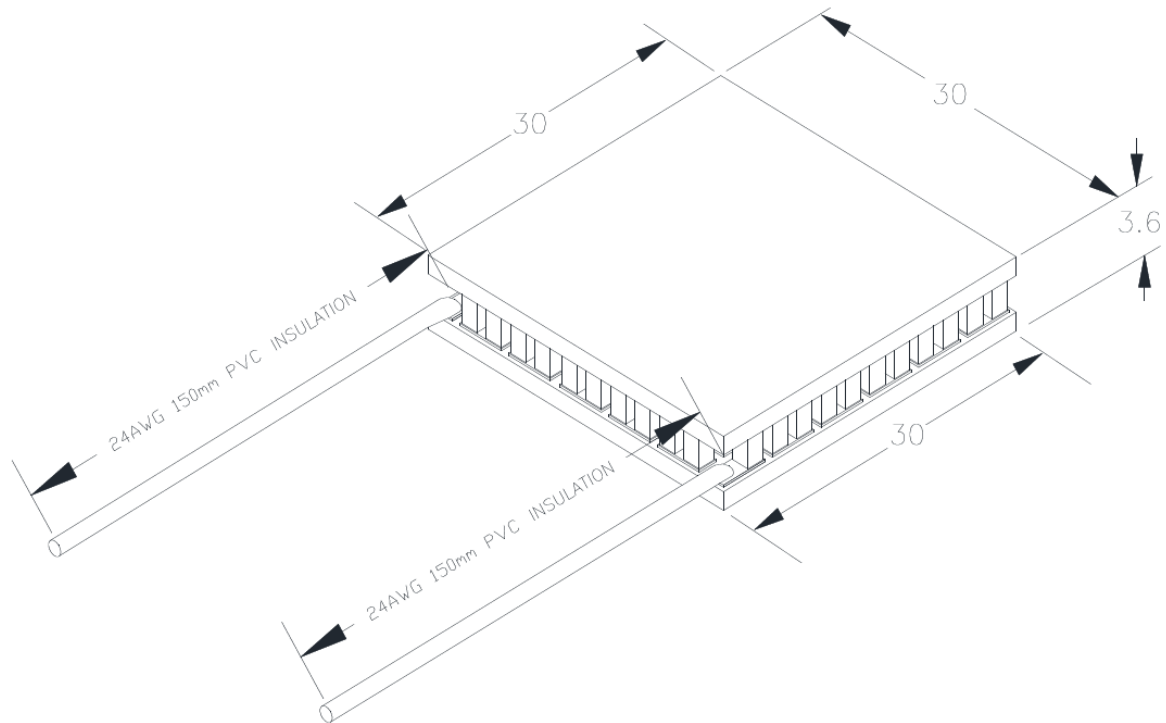

Operation Tips:

- **Maximum Operating Temperature: 90°C**
- **Do not exceed I_{max} or V_{max} when operating module**
- **Please consult Wakefield-Vette for moisture and corrosion protection options as well as specific application inquiries**

Thermoelectric Cooler Performance Specifications



TEC-30-39-71

Hot Side Temperature(°C)	27°C	50°C
Qmax (Watts)	18.7	21.9
Delta Tmax(°C)	68	75
I _{max} (Amps)	4.0	4.0
V _{max} (Volts)	8.6	9.6
Module Resistance(Ohms)	1.86	2.1

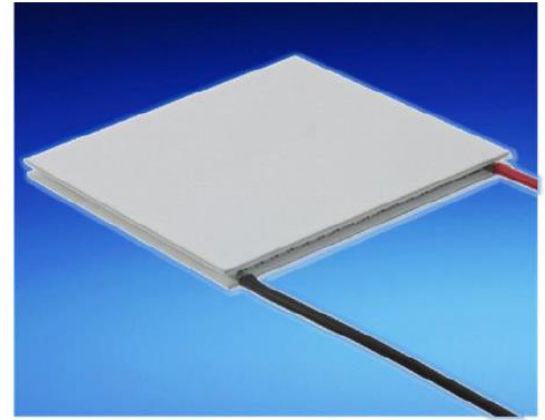

**Tolerances for thermal and electrical parameters ± 10%.

Performance Curves Th=25°C

Performance Curves Th=50°C

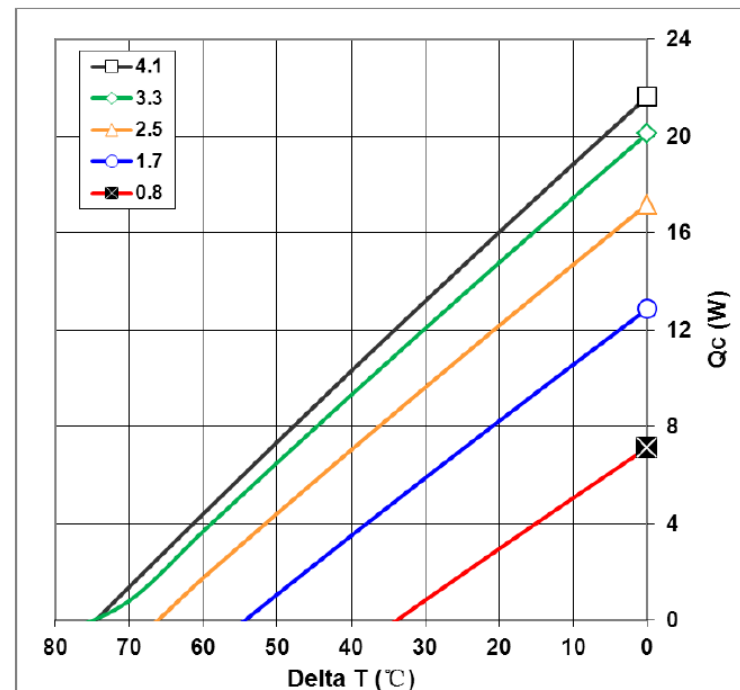
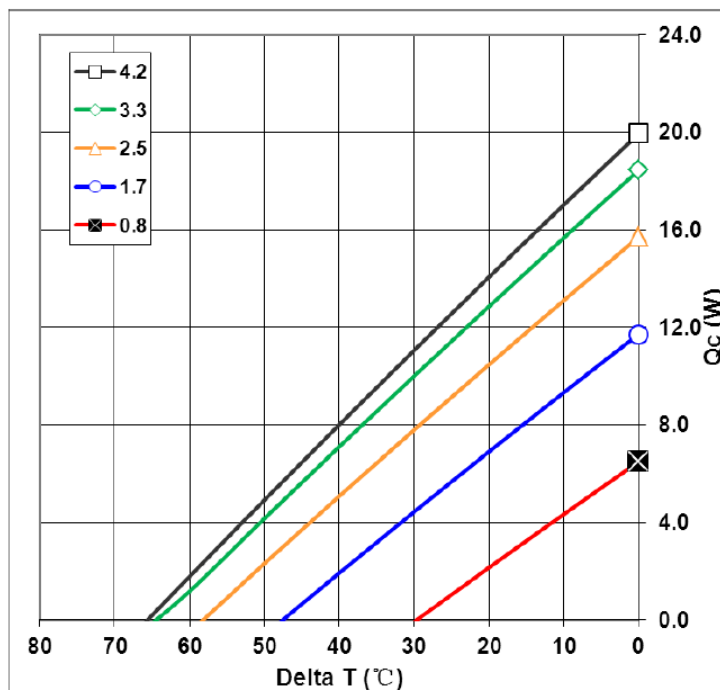
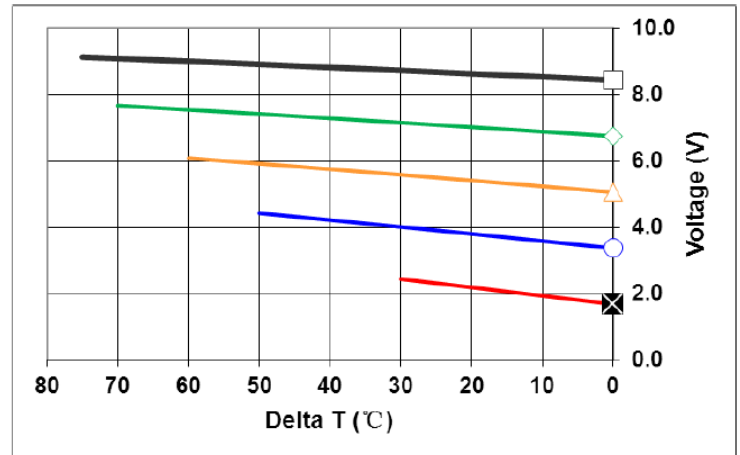
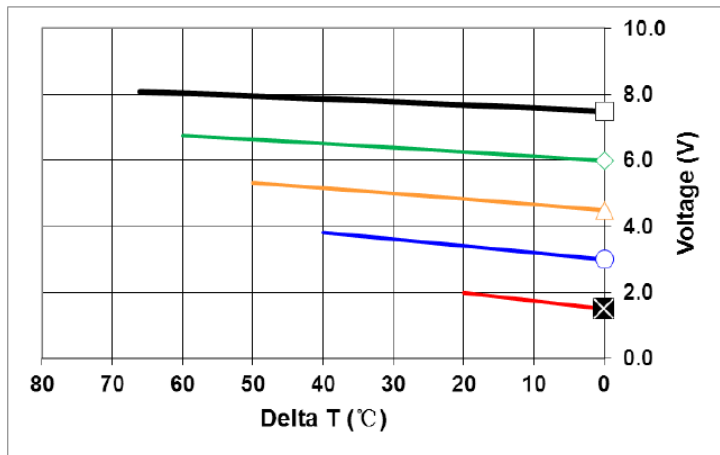

Mechanical Drawing:

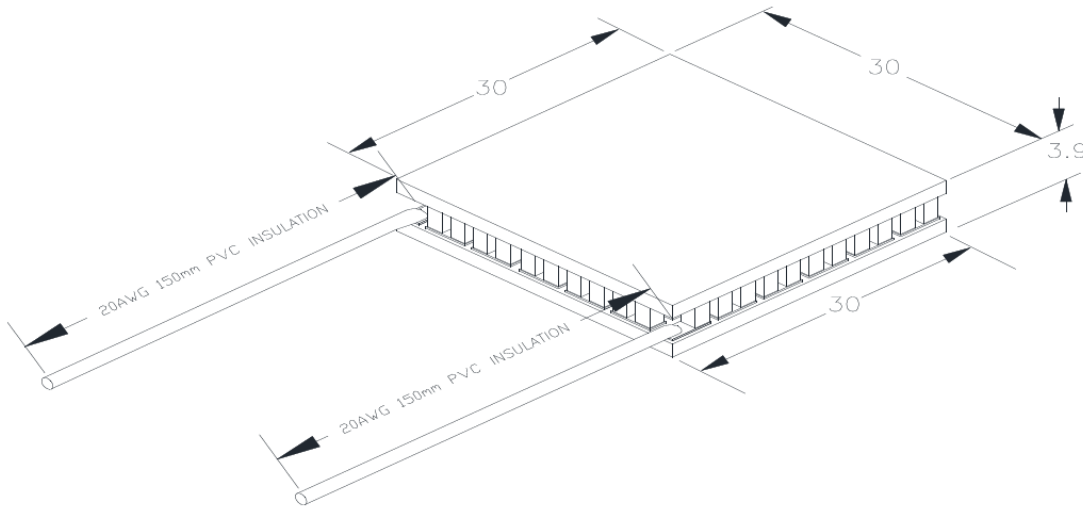

Operation Tips:

- **Maximum Operating Temperature: 90°C**
- **Do not exceed I_{max} or V_{max} when operating module**
- **Please consult Wakefield-Vette for moisture and corrosion protection options as well as specific application inquiries**

Thermoelectric Cooler Performance Specifications



TEC-30-36-71

Hot Side Temperature(°C)	27°C	50 °C
Qmax (Watts)	28.7	31.2
Delta Tmax(°C)	68	75
I _{max} (Amps)	6.0	6.0
V _{max} (Volts)	8.6	9.5
Module Resistance(Ohms)	1.24	1.41

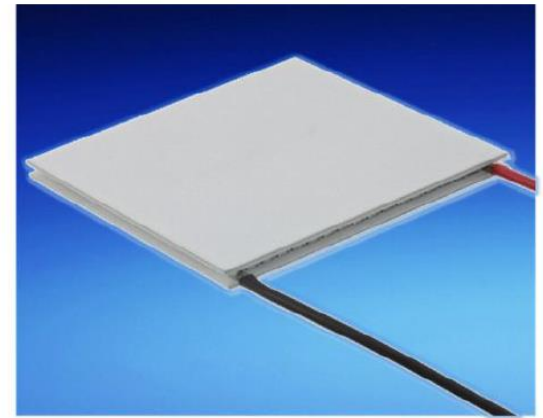

**Tolerances for thermal and electrical parameters ± 10%.

Performance Curves Th=25 °C

Performance Curves Th=50 °C

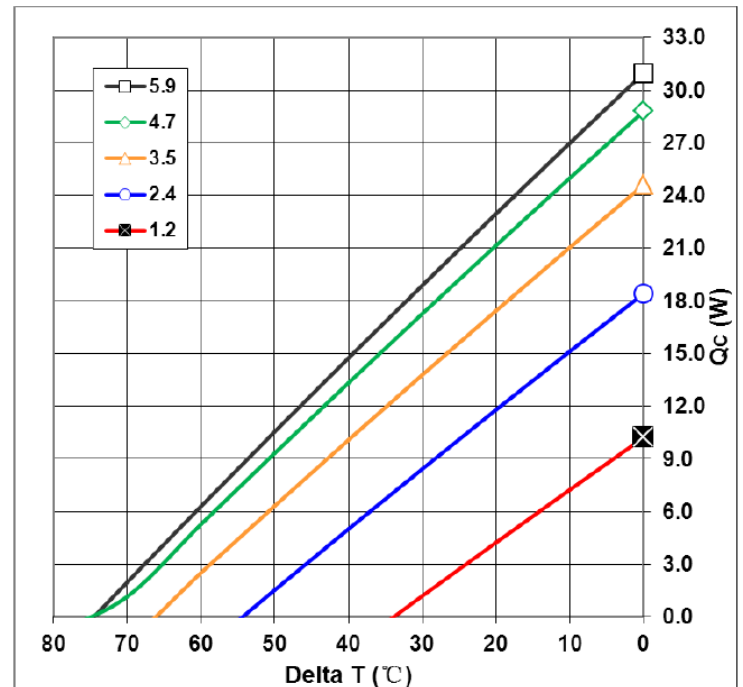
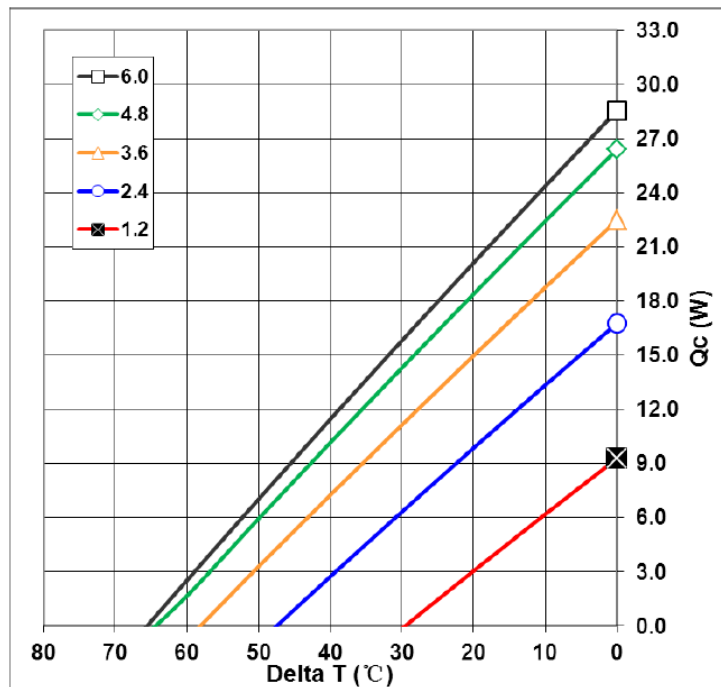
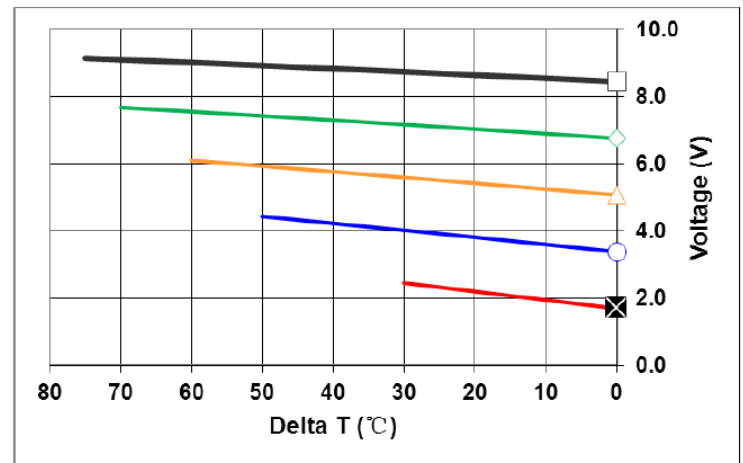
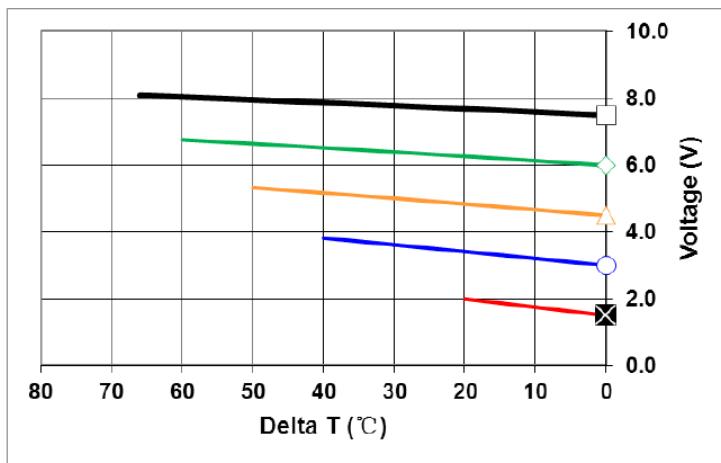

Wakefield-Vette reserves the right to change these specifications without notice

Mechanical Drawing:

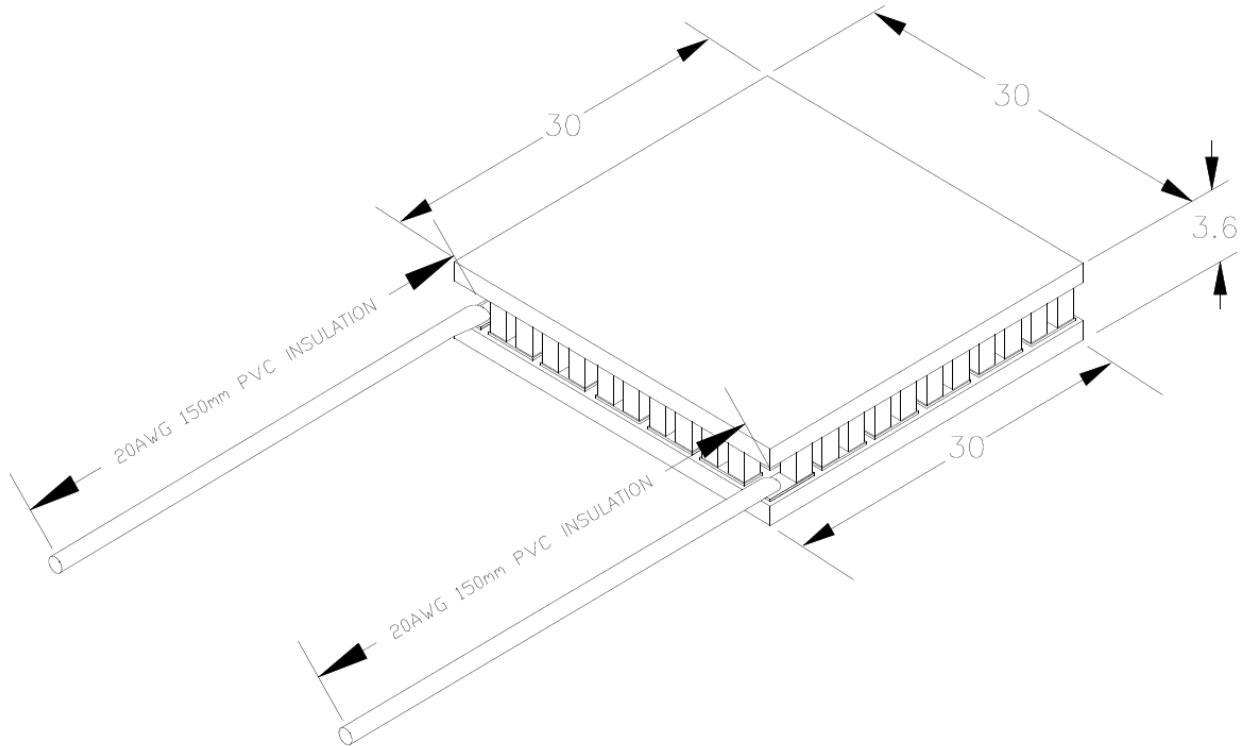

Operation Tips:

- **Maximum Operating Temperature: 90°C**
- **Do not exceed I_{max} or V_{max} when operating module**
- **Please consult Wakefield-Vette for moisture and corrosion protection options as well as specific application inquiries**

Thermoelectric Cooler Performance Specifications



TEC-40-36-127

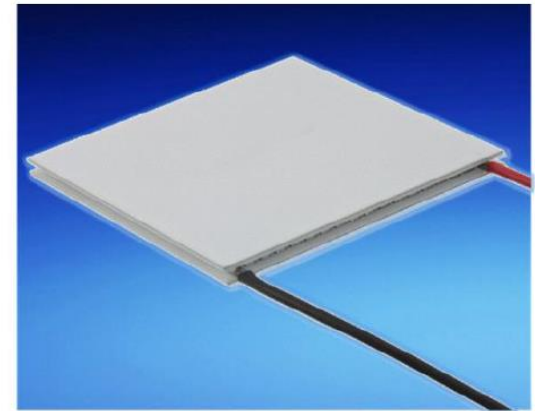

Hot Side Temperature(°C)	27 °C	50 °C
Qmax (Watts)	51.4	55
Delta Tmax(°C)	68	75
I _{max} (Amps)	6.0	6.0
V _{max} (Volts)	15.4	16.4
Module Resistance(Ohms)	2.17	2.54

**Tolerances for thermal and electrical parameters ± 10%.

Performance Curves Th=25 °C

Performance Curves Th=50 °C

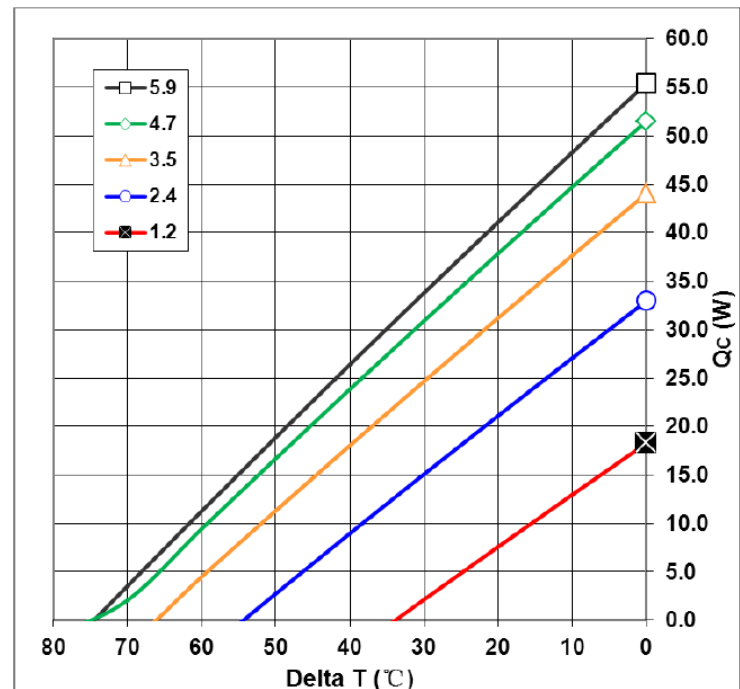
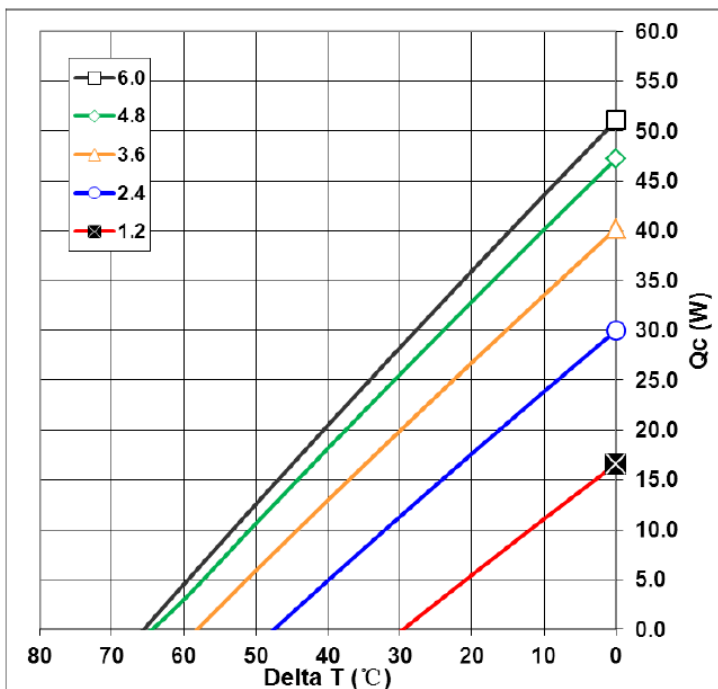
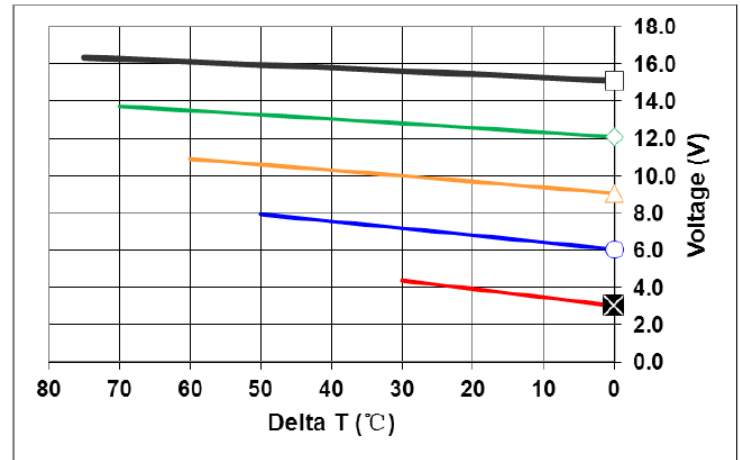
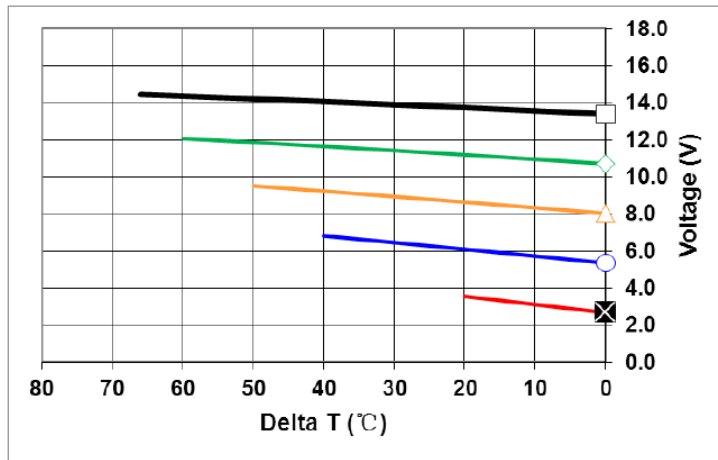

Mechanical Drawing:

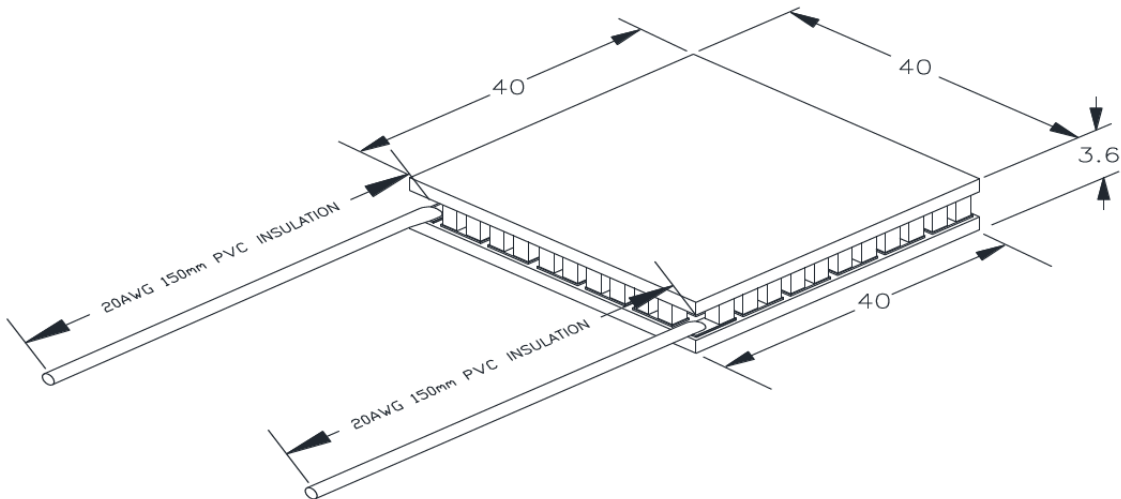

Operation Tips:

- **Maximum Operating Temperature: 90°C**
- **Do not exceed I_{max} or V_{max} when operating module**
- **Please consult Wakefield-Vette for moisture and corrosion protection options as well as specific application inquiries**

Thermoelectric Cooler Performance Specifications



TEC-20-33-31

Hot Side Temperature(°C)	27 °C	50 °C
Qmax (Watts)	16.8	20.3
Delta Tmax(°C)	68	75
I _{max} (Amps)	8.5	8.5
V _{max} (Volts)	3.75	4.1
Module Resistance(Ohms)	0.38	0.42

**Tolerances for thermal and electrical parameters ± 10%.

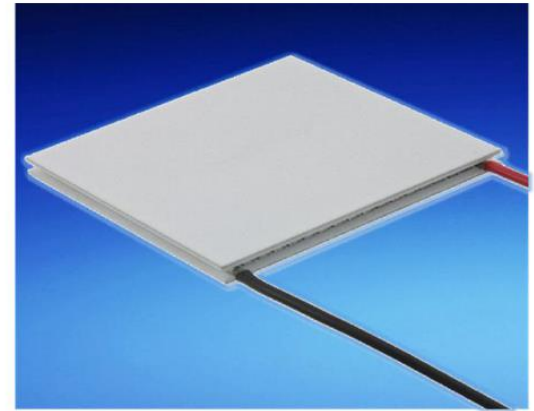

Performance Curves Th=25 °C

Performance Curves Th=50 °C

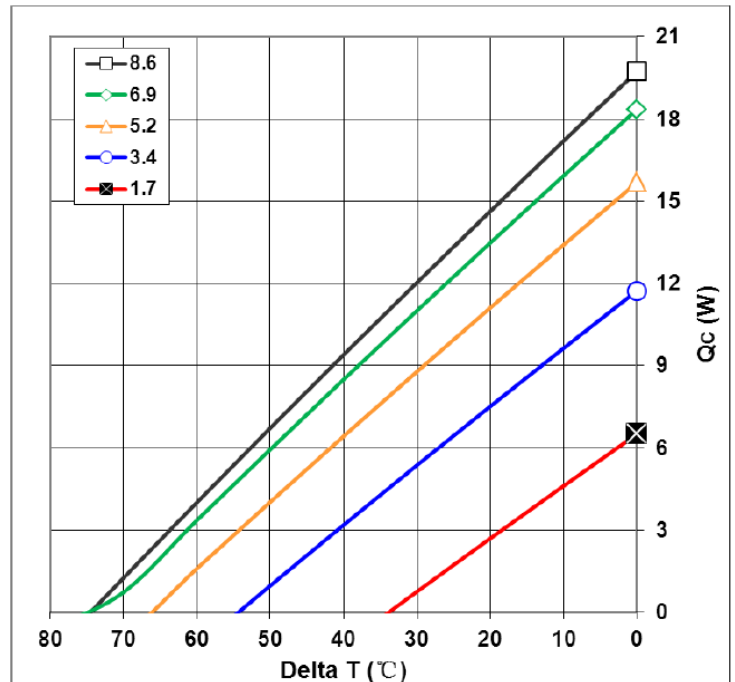
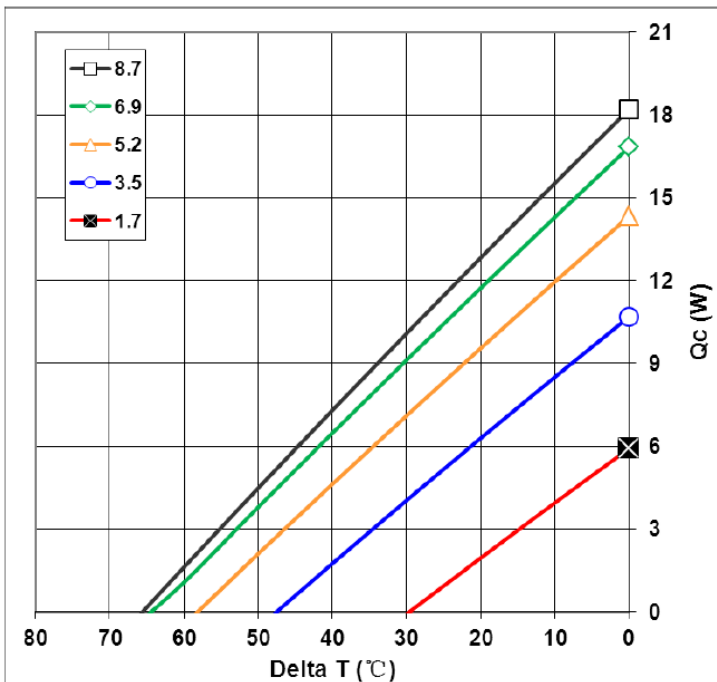
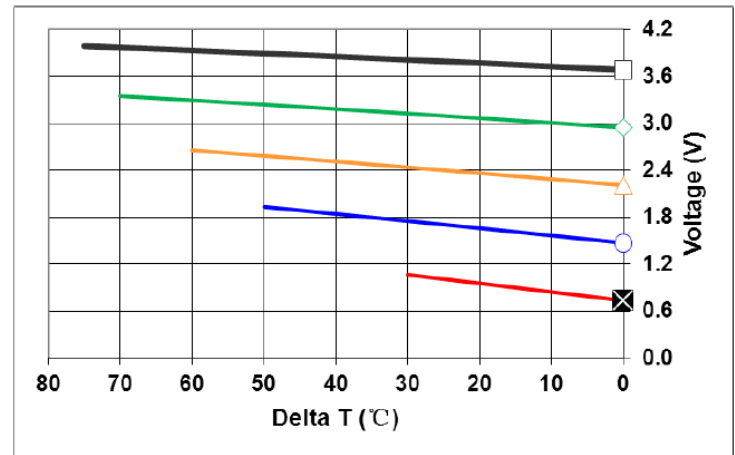
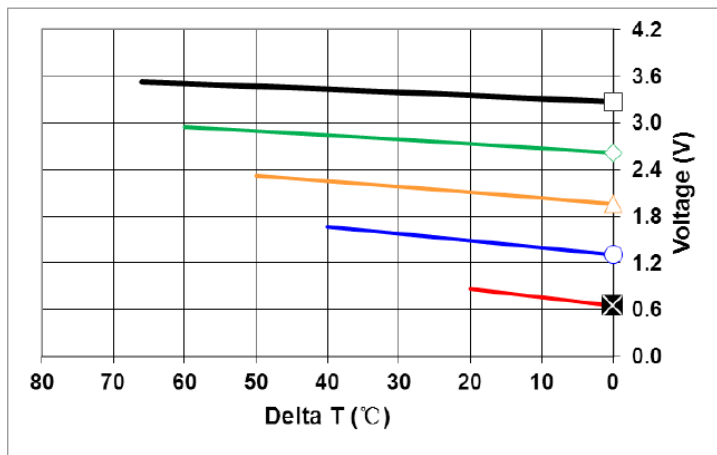

Mechanical Drawing:

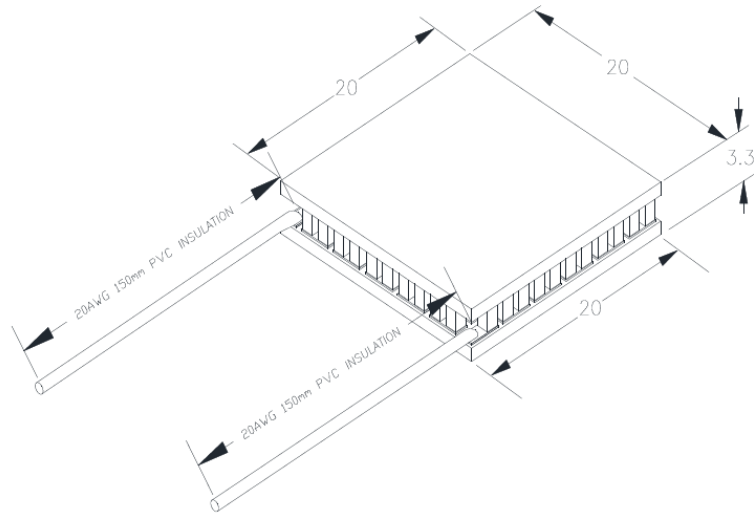

Operation Tips:

- **Maximum Operating Temperature: 90°C**
- **Do not exceed I_{max} or V_{max} when operating module**
- **Please consult Wakefield-Vette for moisture and corrosion protection options as well as specific application inquiries**

Thermoelectric Cooler Performance Specifications



TEC-30-33-71

Hot Side Temperature(°C)	27 °C	50 °C
Qmax (Watts)	38.5	46
Delta Tmax(°C)	68	75
I _{max} (Amps)	8.5	8.5
V _{max} (Volts)	8.6	9.6
Module Resistance(Ohms)	0.86	0.97

**Tolerances for thermal and electrical parameters ± 10%.

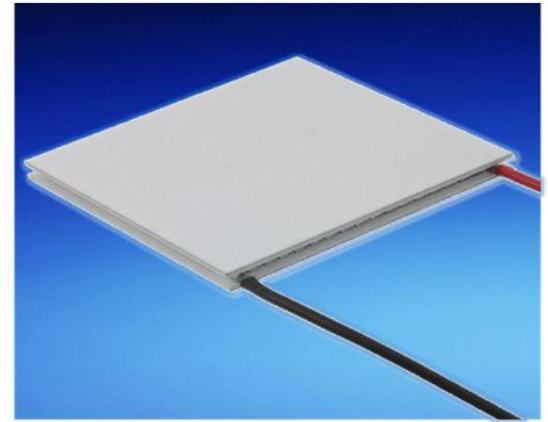

Performance Curves Th=25 °C

Performance Curves Th=50 °C

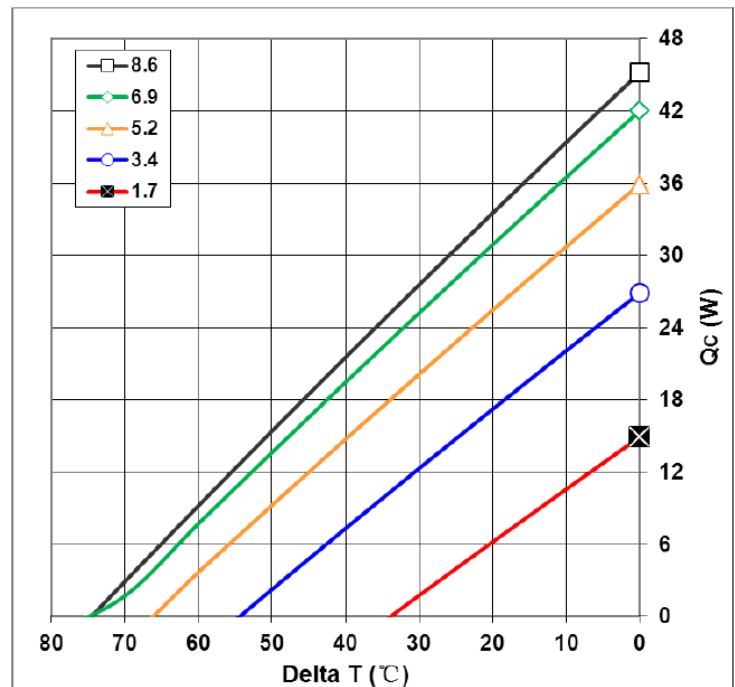
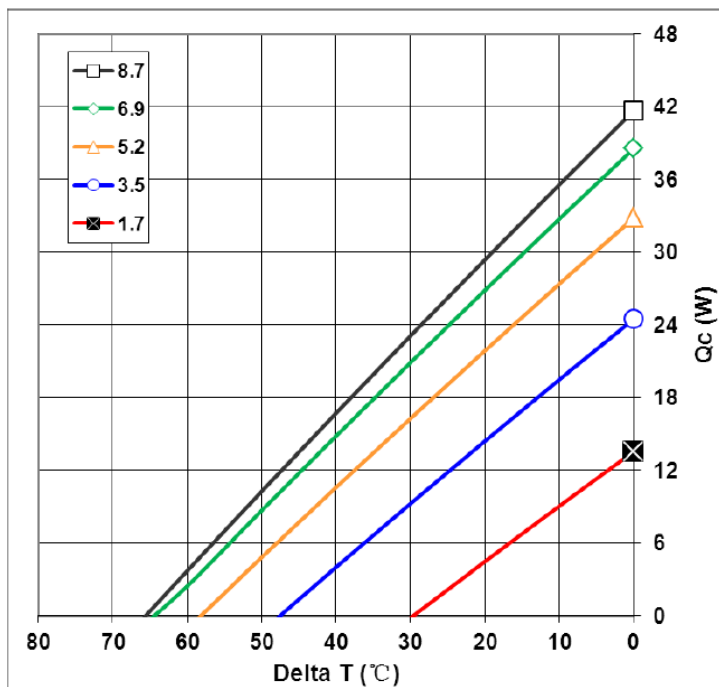
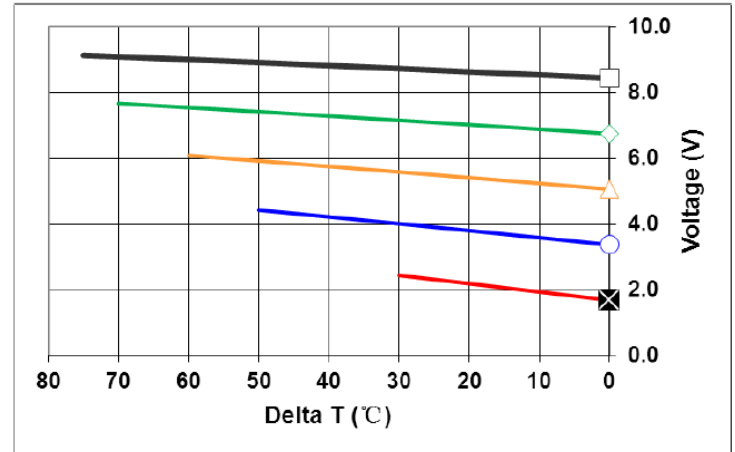
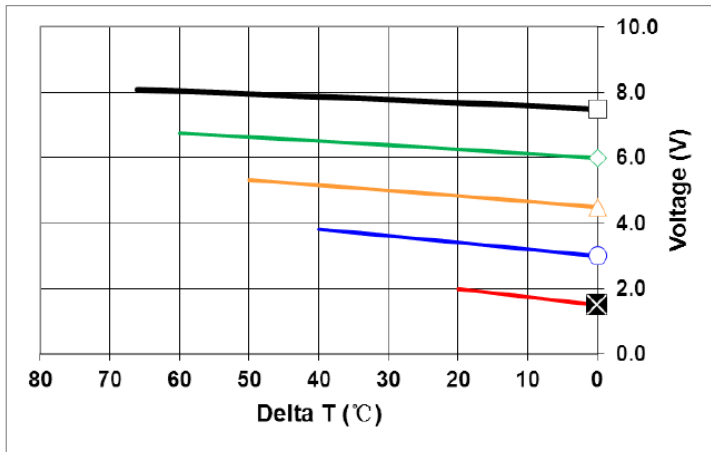

Mechanical Drawing:

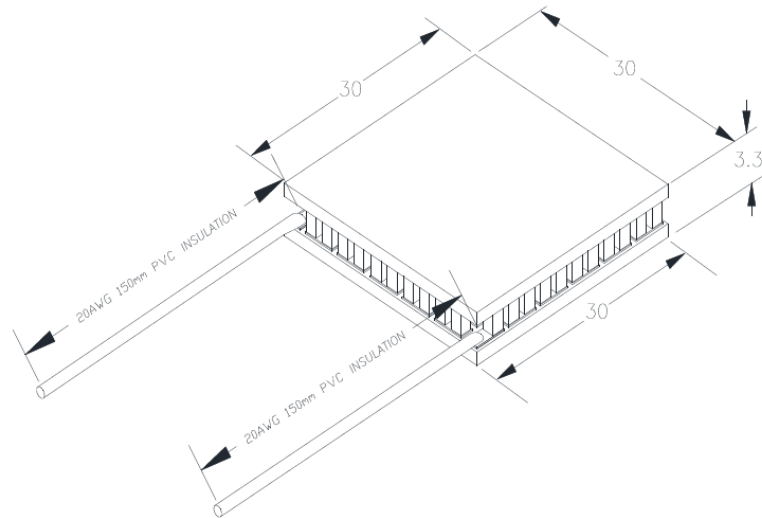

Operation Tips:

- **Maximum Operating Temperature: 90°C**
- **Do not exceed I_{max} or V_{max} when operating module**
- **Please consult Wakefield-Vette for moisture and corrosion protection options as well as specific application inquiries**