



# 60EPU06PbF 60APU06PbF

## Ultrafast Soft Recovery Diode

### Features

- Ultrafast Recovery
- 175°C Operating Junction Temperature
- Lead-Free ("PbF" suffix)

### Benefits

- Reduced RFI and EMI
- Higher Frequency Operation
- Reduced Snubbing
- Reduced Parts Count

### Description/ Applications

These diodes are optimized to reduce losses and EMI/ RFI in high frequency power conditioning systems. The softness of the recovery eliminates the need for a snubber in most applications. These devices are ideally suited for HF welding, power converters and other applications where switching losses are not significant portion of the total losses.

$$t_{rr} = 34\text{ns (typ)}$$

$$I_{F(AV)} = 60\text{Amp}$$



$$V_R = 600\text{V}$$

### Absolute Maximum Ratings

Parameters	Max	Units
$V_R$ Cathode to Anode Voltage	600	V
$I_{F(AV)}$ Continuous Forward Current, $T_C = 116^\circ\text{C}$	60	A
$I_{FSM}$ Single Pulse Forward Current, $T_C = 25^\circ\text{C}$	600	
$I_{FRM}$ ① Maximum Repetitive Forward Current	120	
$T_J, T_{STG}$ Operating Junction and Storage Temperatures	- 55 to 175	$^\circ\text{C}$

① Square Wave, 20kHz

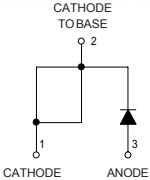
### Case Styles

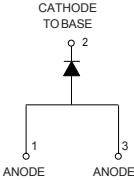
<p><b>60EPU06PbF</b></p>  <div style="text-align: center;">  <p>CATHODE TO BASE</p> <p>CATHODE ANODE</p> </div> <p><b>TO-247AC (Modified)</b></p>	<p><b>60APU06PbF</b></p>  <div style="text-align: center;">  <p>CATHODE TO BASE</p> <p>ANODE ANODE</p> </div> <p><b>TO-247AC</b></p>
---	--

**Electrical Characteristics @ T<sub>J</sub> = 25°C (unless otherwise specified)**

Parameters	Min	Typ	Max	Units	Test Conditions
V <sub>BR</sub> , V <sub>r</sub> Breakdown Voltage, Blocking Voltage	600	-	-	V	I <sub>R</sub> = 100μA
V <sub>F</sub> Forward Voltage	-	1.35	1.68	V	I <sub>F</sub> = 60A
	-	1.20	1.42	V	I <sub>F</sub> = 60A, T <sub>J</sub> = 125°C
	-	1.11	1.30	V	I <sub>F</sub> = 60A, T <sub>J</sub> = 175°C
I <sub>R</sub> Reverse Leakage Current	-	-	50	μA	V <sub>R</sub> = V <sub>R</sub> Rated
	-	-	500	μA	T <sub>J</sub> = 150°C, V <sub>R</sub> = V <sub>R</sub> Rated
C <sub>T</sub> Junction Capacitance	-	39	-	pF	V <sub>R</sub> = 600V

**Dynamic Recovery Characteristics @ T<sub>J</sub> = 25°C (unless otherwise specified)**

Parameters	Min	Typ	Max	Units	Test Conditions
t <sub>rr</sub> Reverse Recovery Time	-	34	45	ns	I <sub>F</sub> = 1A, di <sub>F</sub> /dt = 200A/μs, V <sub>R</sub> = 30V T <sub>J</sub> = 25°C I <sub>F</sub> = 60A V <sub>R</sub> = 200V di <sub>F</sub> /dt = 200A/μs
	-	81	-		
	-	164	-		
I <sub>RRM</sub> Peak Recovery Current	-	7.4	-	A	T <sub>J</sub> = 25°C T <sub>J</sub> = 125°C
	-	17.0	-		
Q <sub>rr</sub> Reverse Recovery Charge	-	300	-	nC	T <sub>J</sub> = 25°C T <sub>J</sub> = 125°C
	-	1394	-		

**Thermal - Mechanical Characteristics**

Parameters	Min	Typ	Max	Units
R <sub>thJC</sub> Thermal Resistance, Junction to Case			0.63	K/W
R <sub>thCS</sub> ② Thermal Resistance, Case to Heatsink		0.2		
Wt Weight		5.5		g
		0.2		(oz)
T Mounting Torque	1.2		2.4	N * m
	10		20	lbf.in
Marking Device	60EPU06, 60APU06			

② Mounting Surface, Flat, Smooth and Greased

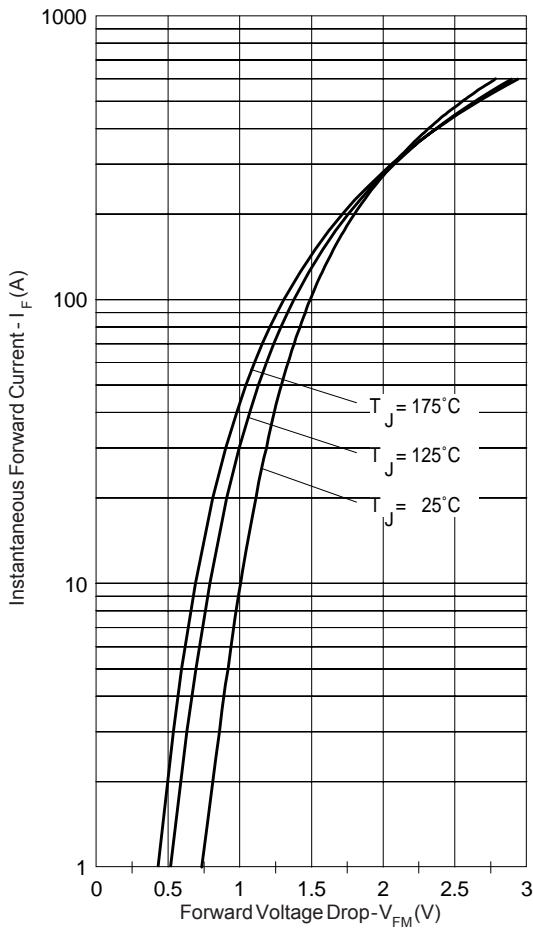

Fig. 1 - Typical Forward Voltage Drop Characteristics

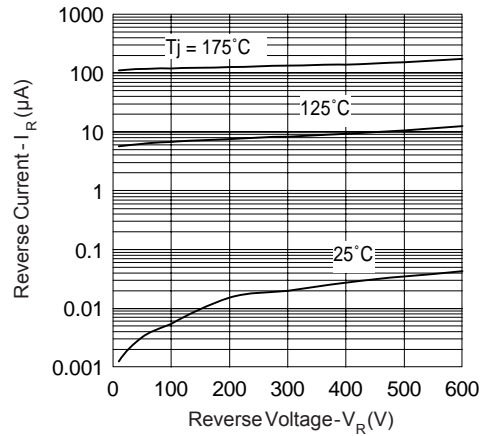

Fig. 2 - Typical Values Of Reverse Current Vs. Reverse Voltage

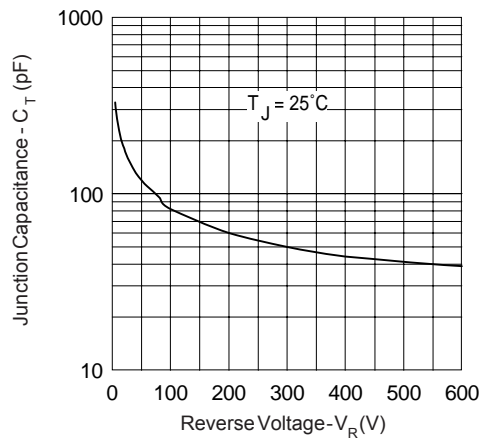

Fig. 3 - Typical Junction Capacitance Vs. Reverse Voltage

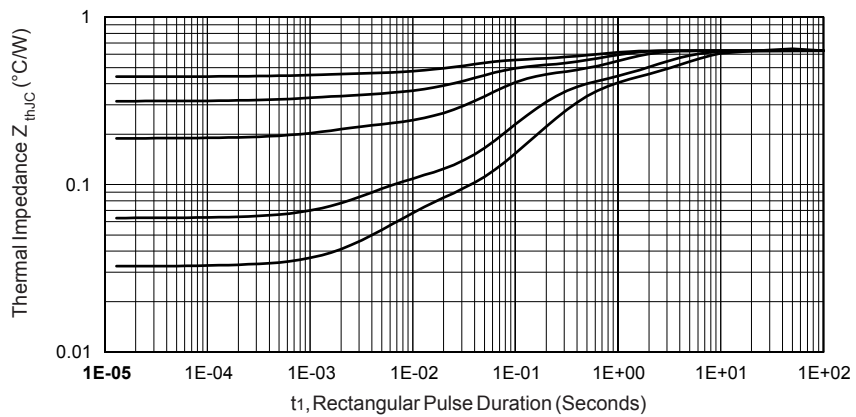

Fig. 4 - Max. Thermal Impedance  $Z_{thJC}$  Characteristics

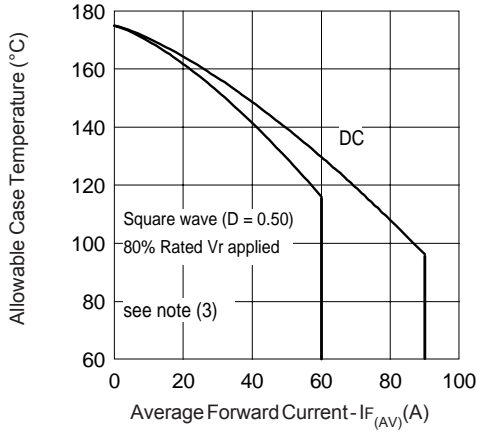

Fig. 5 - Max. Allowable Case Temperature Vs. Average Forward Current

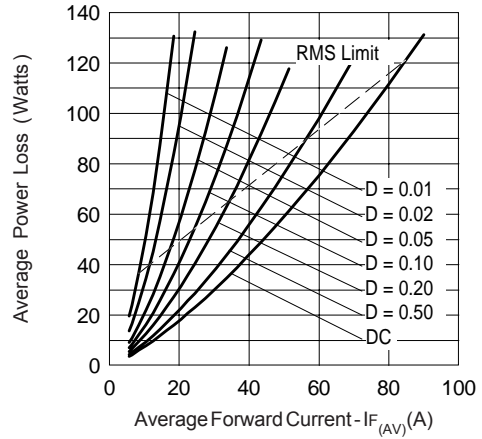

Fig. 6 - Forward Power Loss Characteristics

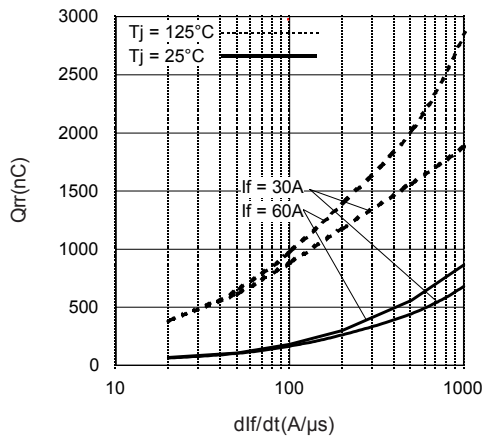

Fig. 7 - Typical Stored Charge vs. dif/dt

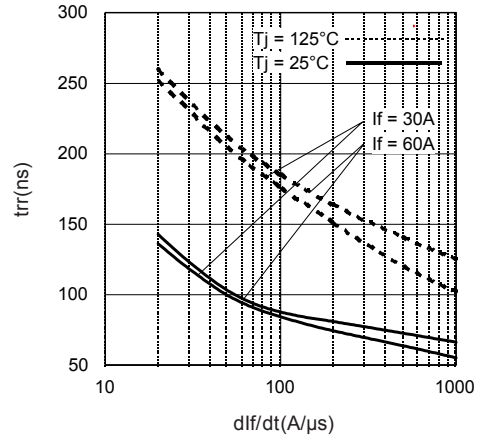

Fig. 87 - Typical Stored Charge vs. dif/dt

- (3) Formula used:  $T_C = T_J - (P_d + P_{d_{REV}}) \times R_{thJC}$ ;  
 $P_d = \text{Forward Power Loss} = I_{F(AV)} \times V_{FM} @ (I_{F(AV)} / D)$  (see Fig. 6);  
 $P_{d_{REV}} = \text{Inverse Power Loss} = V_{R1} \times I_R (1 - D)$ ;  $I_R @ V_{R1} = 80\% \text{ rated } V_R$

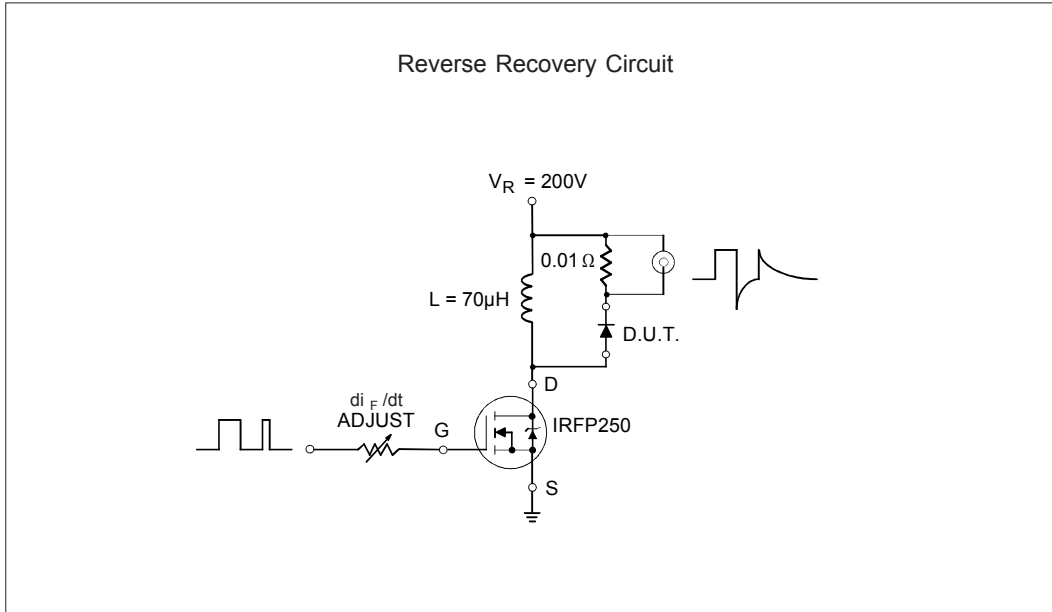

Fig. 9 - Reverse Recovery Parameter Test Circuit

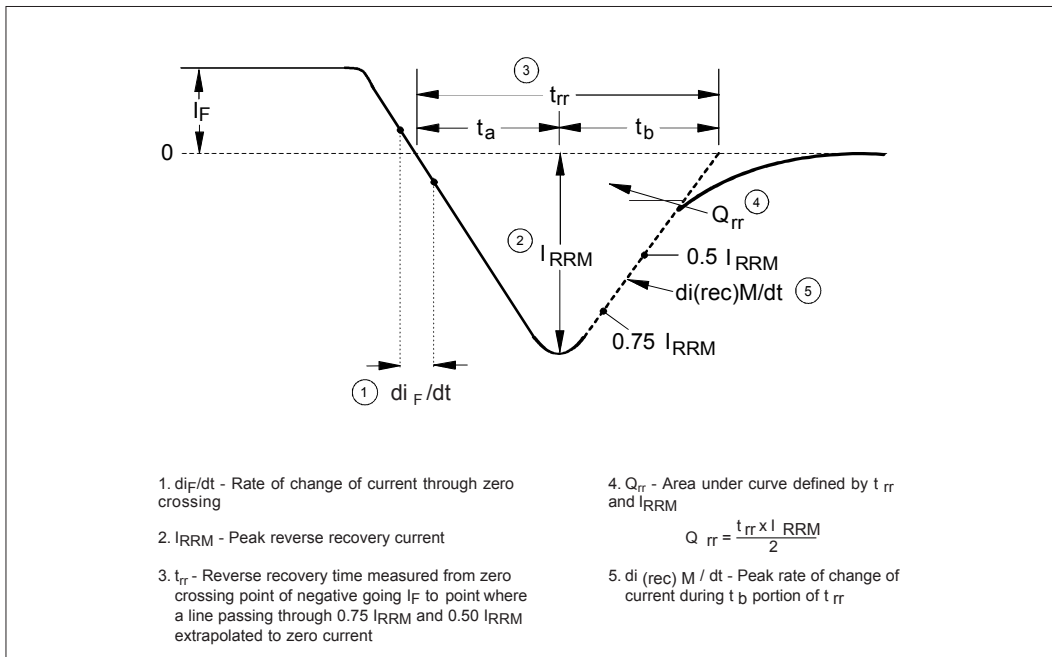
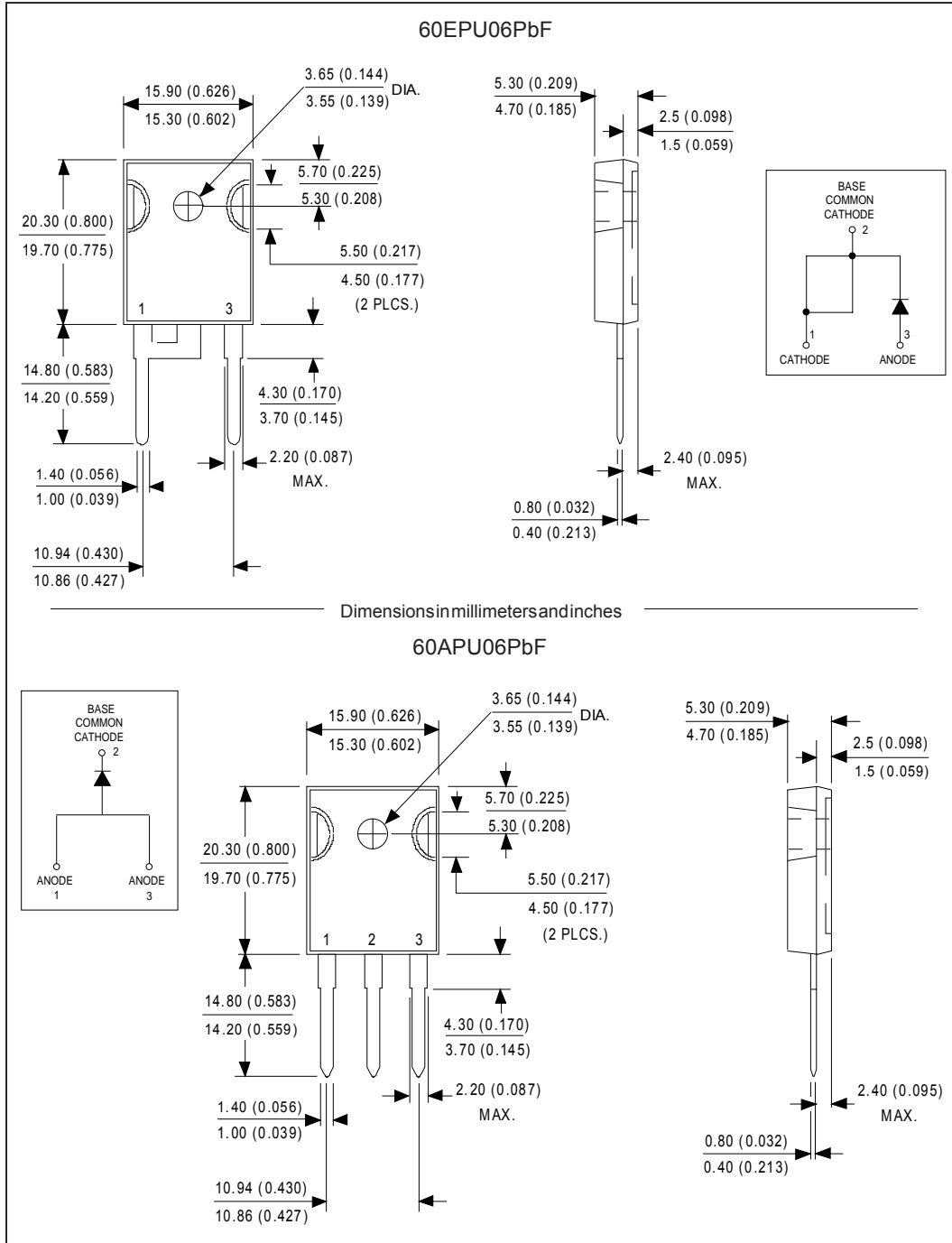
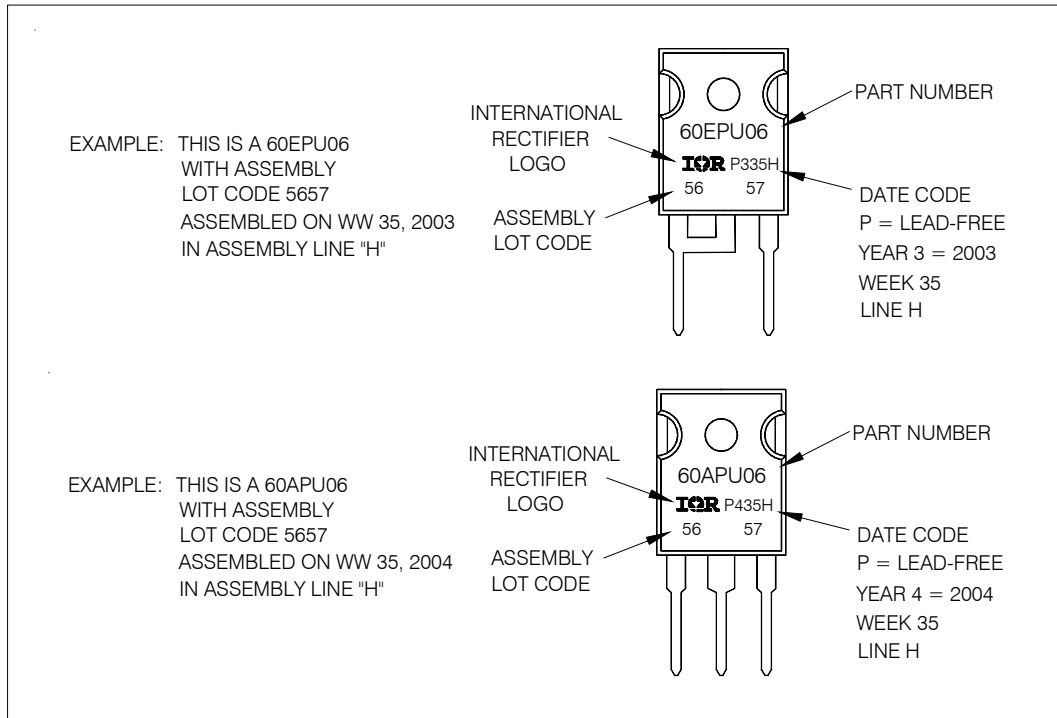

Fig. 10 - Reverse Recovery Waveform and Definitions

Outline Table



Marking Information



Ordering Information Table

Device Code					
60	E	P	U	06	PbF
①	②	③	④	⑤	⑥
<b>1</b>	- Current Rating (60 = 60A)				
<b>2</b>	- Circuit Configuration: E = Single Diode A = Single Diode, 3 pins				
<b>3</b>	- Package: P = TO-247AC (Modified)				
<b>4</b>	- Type of Silicon: U = UltraFast Recovery				
<b>5</b>	- Voltage Rating (06 = 600V)				
<b>6</b>	- • none = Standard Production • PbF = Lead-Free				

60EPU06PbF/ 60APU06PbF

Bulletin PD-21099 11/05

International  
**IOR** Rectifier

Data and specifications subject to change without notice.  
This product has been designed and qualified for Industrial Level and Lead-Free.  
Qualification Standards can be found on IR's Web site.

International  
**IOR** Rectifier

**IR WORLD HEADQUARTERS:** 233 Kansas St., El Segundo, California 90245, USA Tel: (310) 252-7105  
TAC Fax: (310) 252-7309  
11/05





## Notice

The products described herein were acquired by Vishay Intertechnology, Inc., as part of its acquisition of International Rectifier's Power Control Systems (PCS) business, which closed in April 2007. Specifications of the products displayed herein are pending review by Vishay and are subject to the terms and conditions shown below.

Specifications of the products displayed herein are subject to change without notice. Vishay Intertechnology, Inc., or anyone on its behalf, assumes no responsibility or liability for any errors or inaccuracies.

Information contained herein is intended to provide a product description only. No license, express or implied, by estoppel or otherwise, to any intellectual property rights is granted by this document. Except as provided in Vishay's terms and conditions of sale for such products, Vishay assumes no liability whatsoever, and disclaims any express or implied warranty, relating to sale and/or use of Vishay products including liability or warranties relating to fitness for a particular purpose, merchantability, or infringement of any patent, copyright, or other intellectual property right.

The products shown herein are not designed for use in medical, life-saving, or life-sustaining applications. Customers using or selling these products for use in such applications do so at their own risk and agree to fully indemnify Vishay for any damages resulting from such improper use or sale.

International Rectifier®, IR®, the IR logo, HEXFET®, HEXSense®, HEXDIP®, DOL®, INTERO®, and POWIRTRAIN® are registered trademarks of International Rectifier Corporation in the U.S. and other countries. All other product names noted herein may be trademarks of their respective owners.