

High Efficiency LED, \varnothing 5 mm Untinted Non-Diffused

Description

The TLH.5800 series was developed for standard applications which need a very small radiation angle or a very high luminous intensity.

It is housed in a 5 mm untinted non-diffused plastic package. The very small viewing angle of these devices provide a very high luminous intensity.

The yellow and green LEDs are categorized in luminous intensity and additionally in wavelength groups. That allows users to assemble LEDs with uniform appearance.



19223



Features

- Standard T-1 $\frac{3}{4}$ package
- Small mechanical tolerances
- Suitable for DC and high peak current
- Very small viewing angle
- Very high intensity
- Luminous intensity categorized
- Yellow and green color categorized
- Lead-free device

Applications

- Status lights
- OFF / ON indicator
- Lightpipe
- Outdoor display
- Medical instruments
- Maintenance lights
- Legend lights

Parts Table

Part	Color, Luminous Intensity	Angle of Half Intensity ($\pm\phi$)	Technology
TLHY5800	Yellow, $I_V > 100$ mcd	4 °	GaAsP on GaP
TLHG5800	Green, $I_V > 400$ mcd	4 °	GaP on GaP
TLHP5800	Pure green, $I_V > 25$ mcd	4 °	GaP on GaP

Absolute Maximum Ratings

$T_{amb} = 25$ °C, unless otherwise specified

TLHY5800 , TLHG5800 , TLHP5800

Parameter	Test condition	Symbol	Value	Unit
Reverse voltage		V_R	6	V
DC Forward current	$T_{amb} \leq 65$ °C	I_F	30	mA
Surge forward current	$t_p \leq 10$ μ s	I_{FSM}	1	A
Power dissipation	$T_{amb} \leq 65$ °C	P_V	100	mW
Junction temperature		T_j	100	°C
Operating temperature range		T_{amb}	- 40 to + 100	°C
Storage temperature range		T_{stg}	- 55 to + 100	°C
Soldering temperature	$t \leq 5$ s, 2 mm from body	T_{sd}	260	°C
Thermal resistance junction/ambient		R_{thJA}	350	K/W

Optical and Electrical Characteristics

T_{amb} = 25 °C, unless otherwise specified

Yellow

TLHY5800

Parameter	Test condition	Symbol	Min	Typ.	Max	Unit
Luminous intensity ¹⁾	I _F = 20 mA	I _V	100	250		mcd
Dominant wavelength	I _F = 10 mA	λ _d	581		594	nm
Peak wavelength	I _F = 10 mA	λ _p		585		nm
Angle of half intensity	I _F = 10 mA	φ		± 4		deg
Forward voltage	I _F = 20 mA	V _F		2.4	3	V
Reverse voltage	I _R = 10 μA	V _R	6	15		V
Junction capacitance	V _R = 0, f = 1 MHz	C _j		50		pF

¹⁾ in one Packing Unit I_{Vmin}/I_{Vmax} ≤ 0.5

Green

TLHG5800

Parameter	Test condition	Symbol	Min	Typ.	Max	Unit
Luminous intensity ¹⁾	I _F = 20 mA	I _V	400	700		mcd
Dominant wavelength	I _F = 10 mA	λ _d	562		575	nm
Peak wavelength	I _F = 10 mA	λ _p		565		nm
Angle of half intensity	I _F = 10 mA	φ		± 4		deg
Forward voltage	I _F = 20 mA	V _F		2.4	3	V
Reverse voltage	I _R = 10 μA	V _R	6	15		V
Junction capacitance	V _R = 0, f = 1 MHz	C _j		50		pF

¹⁾ in one Packing Unit I_{Vmin}/I_{Vmax} ≤ 0.5

Pure green

TLHP5800

Parameter	Test condition	Symbol	Min	Typ.	Max	Unit
Luminous intensity ¹⁾	I _F = 20 mA	I _V	25	85		mcd
Dominant wavelength	I _F = 10 mA	λ _d	555		565	nm
Peak wavelength	I _F = 10 mA	λ _p		555		nm
Angle of half intensity	I _F = 10 mA	φ		± 4		deg
Forward voltage	I _F = 20 mA	V _F		2.4	3	V
Reverse voltage	I _R = 10 μA	V _R	6	15		V
Junction capacitance	V _R = 0, f = 1 MHz	C _j		50		pF

¹⁾ in one Packing Unit I_{Vmin}/I_{Vmax} ≤ 0.5

Typical Characteristics ($T_{amb} = 25\text{ }^{\circ}\text{C}$ unless otherwise specified)

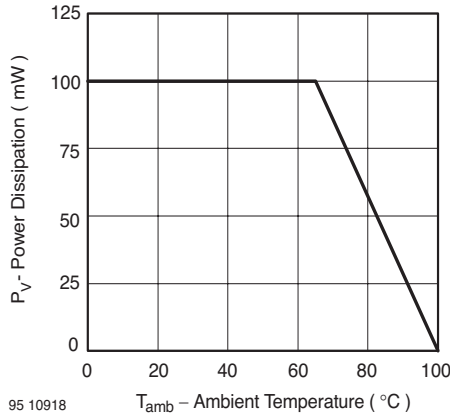

Figure 1. Power Dissipation vs. Ambient Temperature

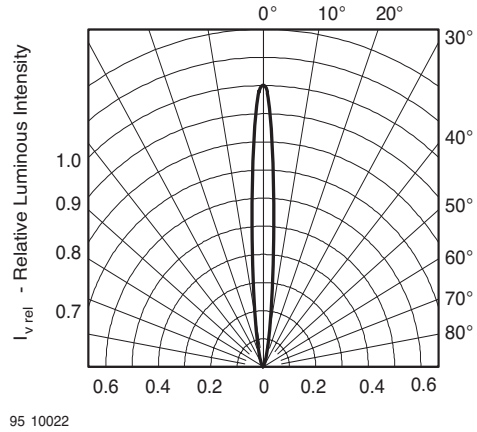

Figure 4. Rel. Luminous Intensity vs. Angular Displacement

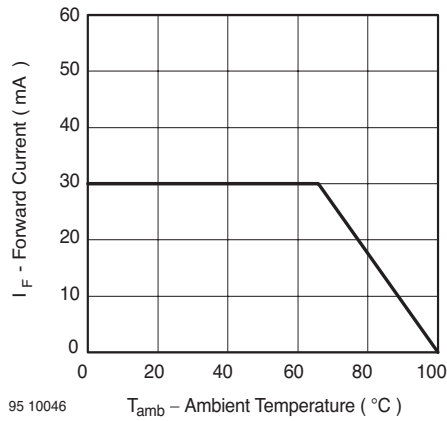

Figure 2. Forward Current vs. Ambient Temperature

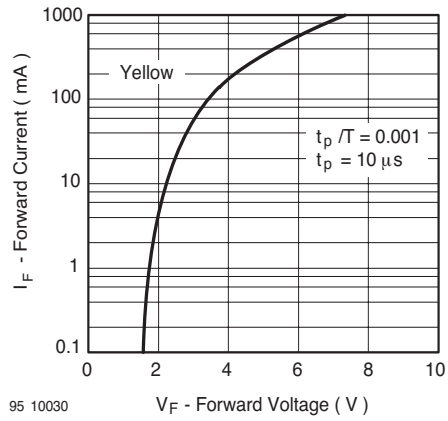

Figure 5. Forward Current vs. Forward Voltage

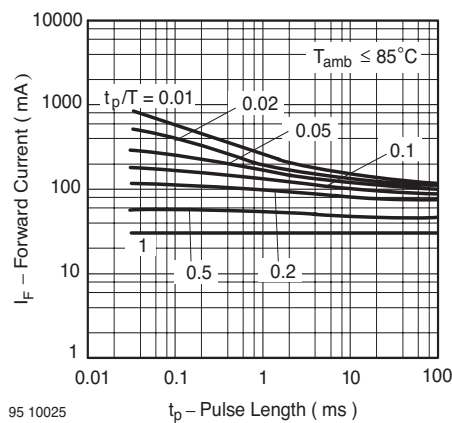

Figure 3. Forward Current vs. Pulse Length

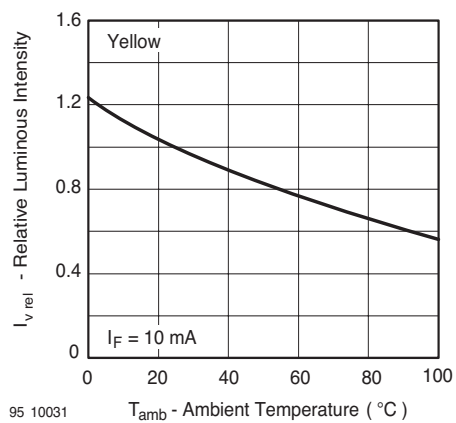

Figure 6. Rel. Luminous Intensity vs. Ambient Temperature

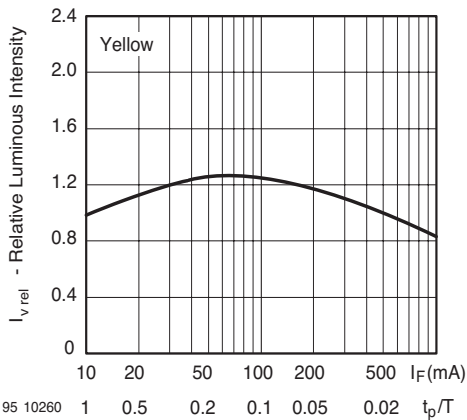

Figure 7. Rel. Lumin. Intensity vs. Forw. Current/Duty Cycle

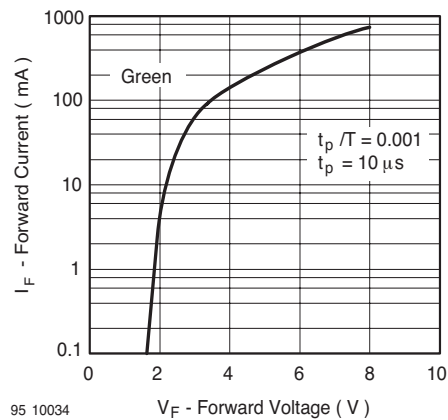

Figure 10. Forward Current vs. Forward Voltage

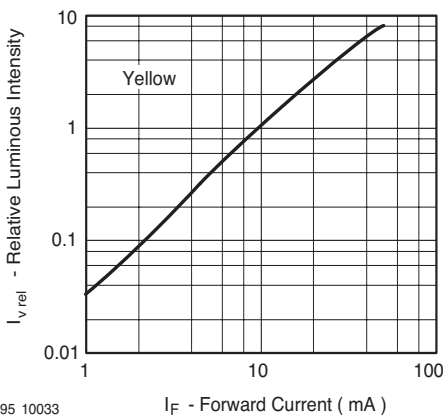

Figure 8. Relative Luminous Intensity vs. Forward Current

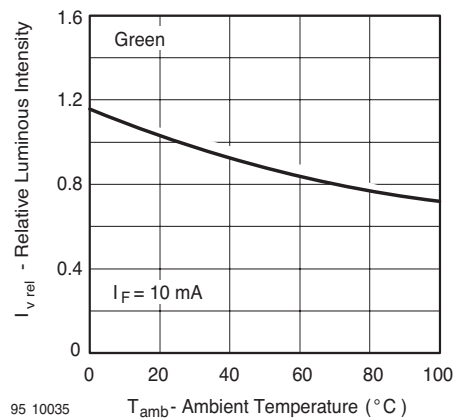

Figure 11. Rel. Luminous Intensity vs. Ambient Temperature

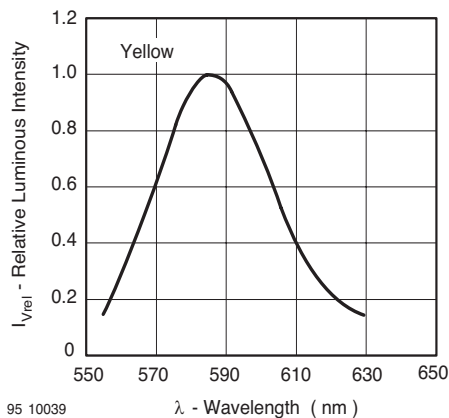

Figure 9. Relative Intensity vs. Wavelength

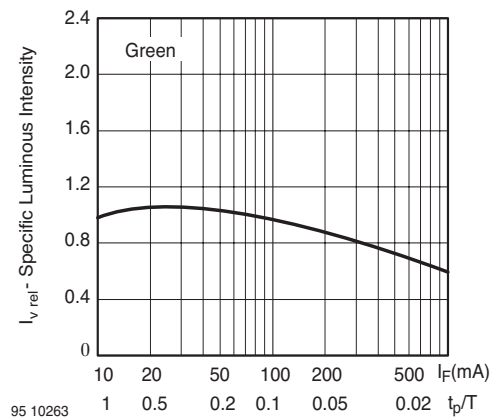

Figure 12. Specific Luminous Intensity vs. Forward Current

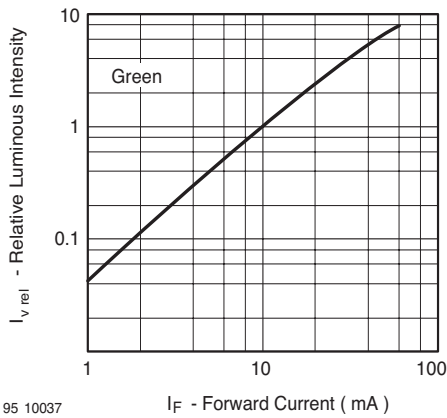

Figure 13. Relative Luminous Intensity vs. Forward Current

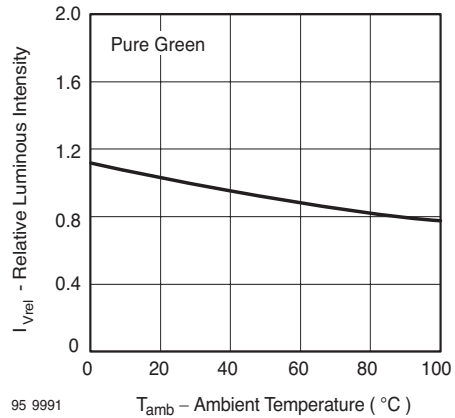

Figure 16. Rel. Luminous Intensity vs. Ambient Temperature

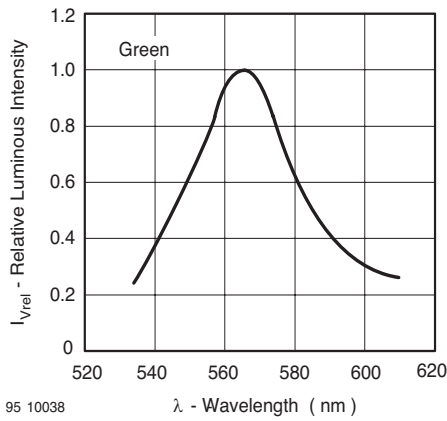

Figure 14. Relative Intensity vs. Wavelength

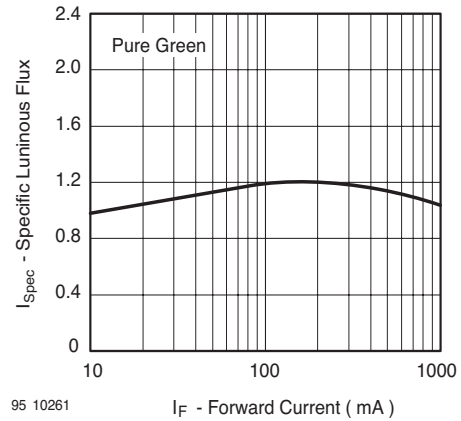

Figure 17. Specific Luminous Intensity vs. Forward Current

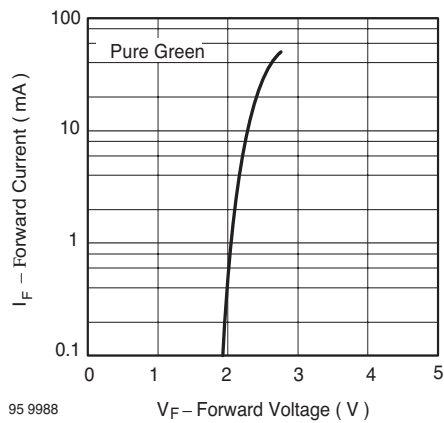

Figure 15. Forward Current vs. Forward Voltage

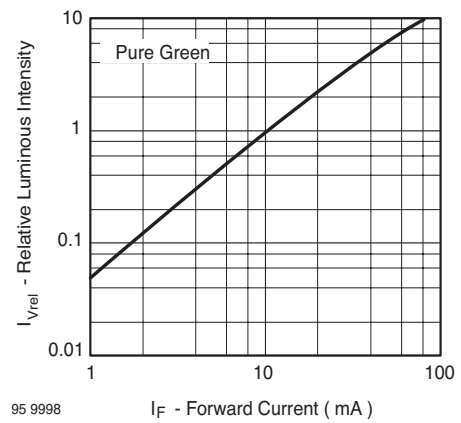

Figure 18. Relative Luminous Intensity vs. Forward Current

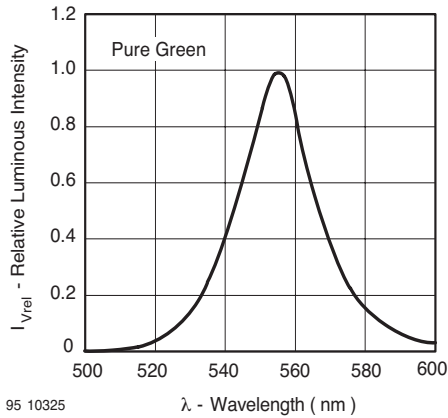
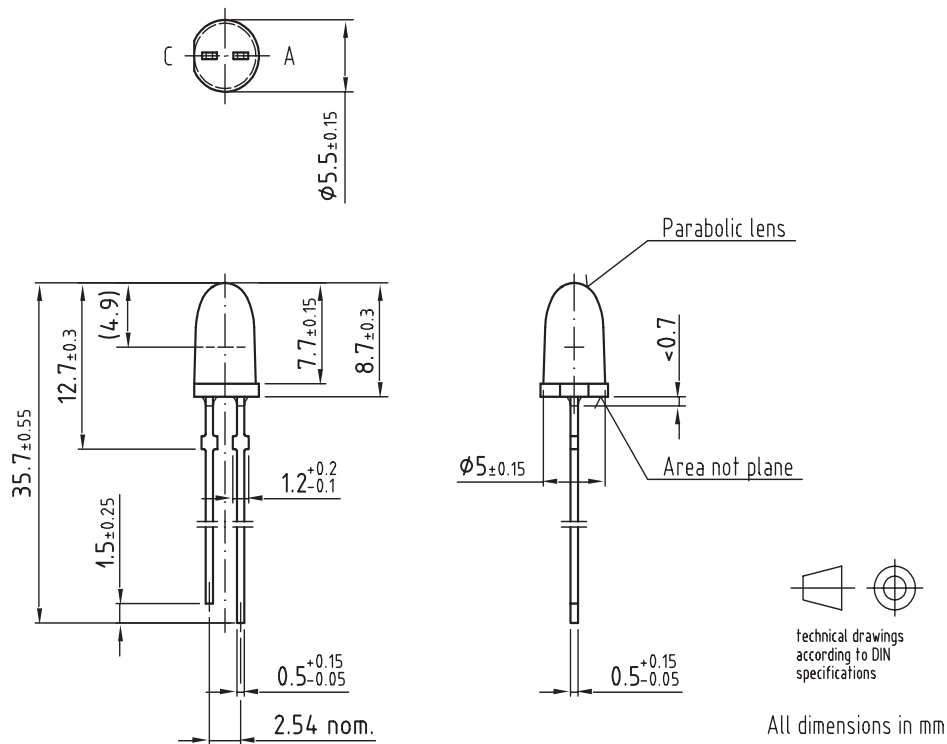

Figure 19. Relative Intensity vs. Wavelength

Package Dimensions in mm



Drawing-No.: 6.544-5310.01-4
Issue: 2; 04.07.03

95 11476



Ozone Depleting Substances Policy Statement

It is the policy of **Vishay Semiconductor GmbH** to

1. Meet all present and future national and international statutory requirements.
2. Regularly and continuously improve the performance of our products, processes, distribution and operating systems with respect to their impact on the health and safety of our employees and the public, as well as their impact on the environment.

It is particular concern to control or eliminate releases of those substances into the atmosphere which are known as ozone depleting substances (ODSs).

The Montreal Protocol (1987) and its London Amendments (1990) intend to severely restrict the use of ODSs and forbid their use within the next ten years. Various national and international initiatives are pressing for an earlier ban on these substances.

Vishay Semiconductor GmbH has been able to use its policy of continuous improvements to eliminate the use of ODSs listed in the following documents.

1. Annex A, B and list of transitional substances of the Montreal Protocol and the London Amendments respectively
2. Class I and II ozone depleting substances in the Clean Air Act Amendments of 1990 by the Environmental Protection Agency (EPA) in the USA
3. Council Decision 88/540/EEC and 91/690/EEC Annex A, B and C (transitional substances) respectively.

Vishay Semiconductor GmbH can certify that our semiconductors are not manufactured with ozone depleting substances and do not contain such substances.

**We reserve the right to make changes to improve technical design
and may do so without further notice.**

Parameters can vary in different applications. All operating parameters must be validated for each customer application by the customer. Should the buyer use Vishay Semiconductors products for any unintended or unauthorized application, the buyer shall indemnify Vishay Semiconductors against all claims, costs, damages, and expenses, arising out of, directly or indirectly, any claim of personal damage, injury or death associated with such unintended or unauthorized use.

Vishay Semiconductor GmbH, P.O.B. 3535, D-74025 Heilbronn, Germany
Telephone: 49 (0)7131 67 2831, Fax number: 49 (0)7131 67 2423



Notice

Specifications of the products displayed herein are subject to change without notice. Vishay Intertechnology, Inc., or anyone on its behalf, assumes no responsibility or liability for any errors or inaccuracies.

Information contained herein is intended to provide a product description only. No license, express or implied, by estoppel or otherwise, to any intellectual property rights is granted by this document. Except as provided in Vishay's terms and conditions of sale for such products, Vishay assumes no liability whatsoever, and disclaims any express or implied warranty, relating to sale and/or use of Vishay products including liability or warranties relating to fitness for a particular purpose, merchantability, or infringement of any patent, copyright, or other intellectual property right.

The products shown herein are not designed for use in medical, life-saving, or life-sustaining applications. Customers using or selling these products for use in such applications do so at their own risk and agree to fully indemnify Vishay for any damages resulting from such improper use or sale.