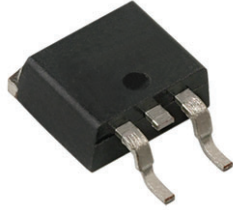
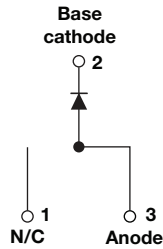

HEXFRED[®]

Ultrafast Soft Recovery Diode, 25 A

 TO-263AB (D²PAK)

FEATURES

- Ultrafast and ultrasoft recovery
- Very low I_{RRM} and Q_{rr}
- Specified at operating conditions
- Meets MSL level 1, per J-STD-020, LF maximum peak of 260 °C
- AEC-Q101 qualified
- Material categorization:
for definitions of compliance please see www.vishay.com/doc?99912

RoHS
 COMPLIANT
 HALOGEN
FREE
BENEFITS

- Reduced RFI and EMI
- Reduced power loss in diode and switching transistor
- Higher frequency operation
- Reduced snubbing
- Reduced parts count

DESCRIPTION

VS-HFA25TB60S is a state of the art ultrafast recovery diode. Employing the latest in epitaxial construction and advanced processing techniques it features a superb combination of characteristics which result in performance which is unsurpassed by any rectifier previously available. With basic ratings of 600 V and 25 A continuous current, the VS-HFA25TB60S is especially well suited for use as the companion diode for IGBTs and MOSFETs. In addition to ultrafast recovery time, the HEXFRED[®] product line features extremely low values of peak recovery current (I_{RRM}) and does not exhibit any tendency to “snap-off” during the t_b portion of recovery. The HEXFRED features combine to offer designers a rectifier with lower noise and significantly lower switching losses in both the diode and the switching transistor. These HEXFRED advantages can help to significantly reduce snubbing, component count and heatsink sizes. The HEXFRED VS-HFA25TB60S is ideally suited for applications in power supplies and power conversion systems (such as inverters), motor drives, and many other similar applications where high speed, high efficiency is needed.

PRODUCT SUMMARY	
Package	TO-263AB (D ² PAK)
$I_{F(AV)}$	25 A
V_R	600 V
V_F at I_F	1.3 V
t_{rr} (typ.)	23 ns
T_J max.	150 °C
Diode variation	Single die

ABSOLUTE MAXIMUM RATINGS				
PARAMETER	SYMBOL	TEST CONDITIONS	VALUES	UNITS
Cathode to anode voltage	V_R		600	V
Maximum continuous forward current	I_F	$T_C = 100\text{ °C}$	25	A
Single pulse forward current	I_{FSM}		225	
Maximum repetitive forward current	I_{FRM}		100	
Maximum power dissipation	P_D	$T_C = 25\text{ °C}$	125	W
		$T_C = 100\text{ °C}$	50	
Operating junction and storage temperature range	T_J, T_{Stg}		-55 to +150	°C



ELECTRICAL SPECIFICATIONS ($T_J = 25\text{ }^\circ\text{C}$ unless otherwise specified)						
PARAMETER	SYMBOL	TEST CONDITIONS	MIN.	TYP.	MAX.	UNITS
Cathode to anode breakdown voltage	V_{BR}	$I_R = 100\ \mu\text{A}$	600	-	-	V
Maximum forward voltage	V_{FM}	$I_F = 25\ \text{A}$	-	1.3	1.7	
		$I_F = 50\ \text{A}$	-	1.5	2.0	
		$I_F = 25\ \text{A}, T_J = 125\text{ }^\circ\text{C}$	-	1.3	1.7	
Maximum reverse leakage current	I_{RM}	$V_R = V_R\ \text{rated}$	-	1.5	20	μA
		$T_J = 125\text{ }^\circ\text{C}, V_R = 0.8 \times V_R\ \text{rated}$	-	600	2000	
Junction capacitance	C_T	$V_R = 200\ \text{V}$	-	55	100	pF
Series inductance	L_S	Measured lead to lead 5 mm from package body	-	8.0	-	nH

DYNAMIC RECOVERY CHARACTERISTICS ($T_J = 25\text{ }^\circ\text{C}$ unless otherwise specified)						
PARAMETER	SYMBOL	TEST CONDITIONS	MIN.	TYP.	MAX.	UNITS
Reverse recovery time See fig. 5	t_{rr}	$I_F = 1.0\ \text{A}, di_F/dt = 200\ \text{A}/\mu\text{s}, V_R = 30\ \text{V}$	-	23	-	ns
	t_{rr1}	$T_J = 25\text{ }^\circ\text{C}$	-	50	75	
	t_{rr2}	$T_J = 125\text{ }^\circ\text{C}$	-	105	160	
Peak recovery current See fig. 6	I_{RRM1}	$T_J = 25\text{ }^\circ\text{C}$	-	4.5	10	A
	I_{RRM2}	$T_J = 125\text{ }^\circ\text{C}$	-	8.0	15	
Reverse recovery charge See fig. 7	Q_{rr1}	$T_J = 25\text{ }^\circ\text{C}$	-	112	375	nC
	Q_{rr2}	$T_J = 125\text{ }^\circ\text{C}$	-	420	1200	
Peak rate of fall recovery current during t_b See fig. 8	$di_{(rec)M}/dt1$	$T_J = 25\text{ }^\circ\text{C}$	-	250	-	$\text{A}/\mu\text{s}$
	$di_{(rec)M}/dt2$	$T_J = 125\text{ }^\circ\text{C}$	-	160	-	

THERMAL - MECHANICAL SPECIFICATIONS						
PARAMETER	SYMBOL	TEST CONDITIONS	MIN.	TYP.	MAX.	UNITS
Lead temperature	T_{lead}	0.063" from case (1.6 mm) for 10 s	-	-	300	$^\circ\text{C}$
Thermal resistance, junction to case	R_{thJC}		-	-	1.0	K/W
Thermal resistance, junction to ambient	R_{thJA}	Typical socket mount	-	-	80	
Weight			-	2.0	-	g
			-	0.07	-	oz.
Marking device		Case style TO-263AB (D ² PAK)	HFA25TB60S			

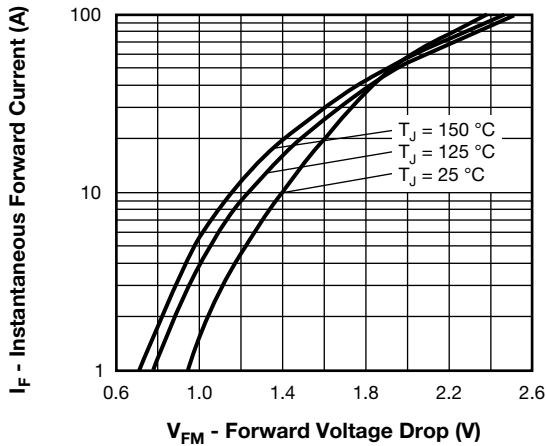

Fig. 1 - Maximum Forward Voltage Drop vs. Instantaneous Forward Current

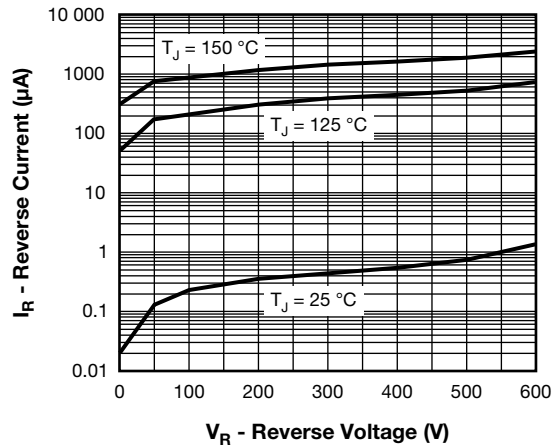

Fig. 2 - Typical Reverse Current vs. Reverse Voltage

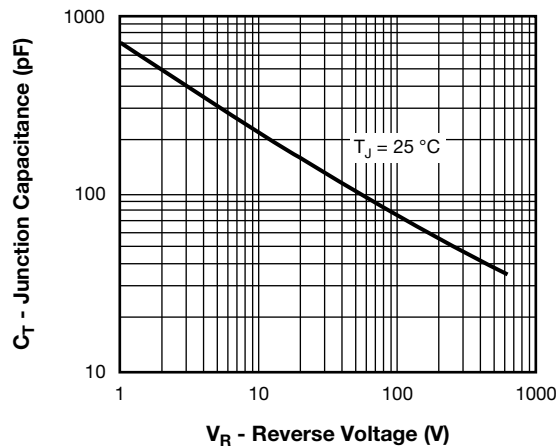

Fig. 3 - Typical Junction Capacitance vs. Reverse Voltage

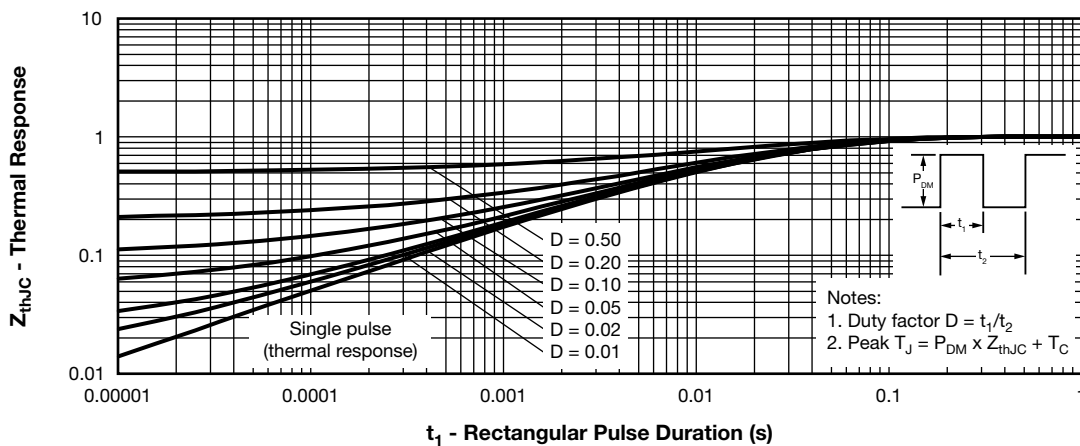

Fig. 4 - Maximum Thermal Impedance Z_{thJC} Characteristics

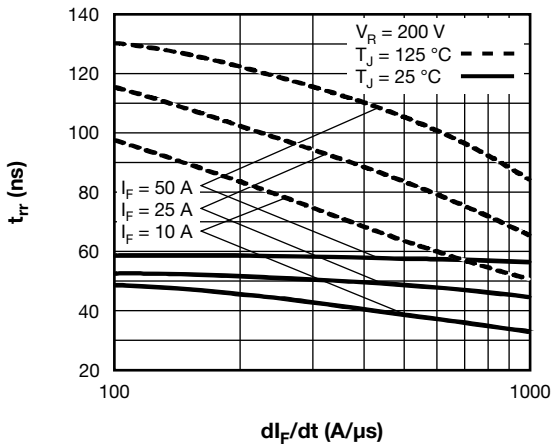

Fig. 5 - Typical Reverse Recovery Time vs. di_F/dt

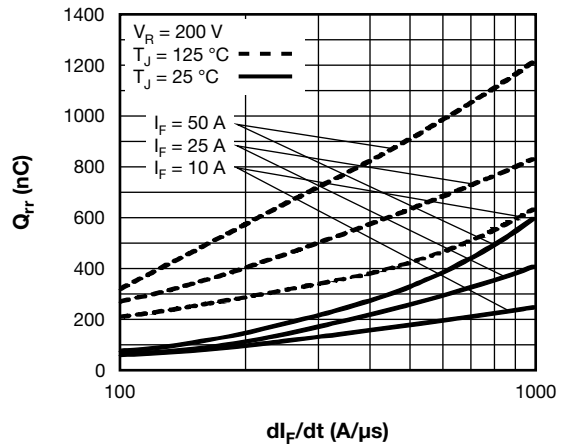

Fig. 7 - Typical Stored Charge vs. di_F/dt

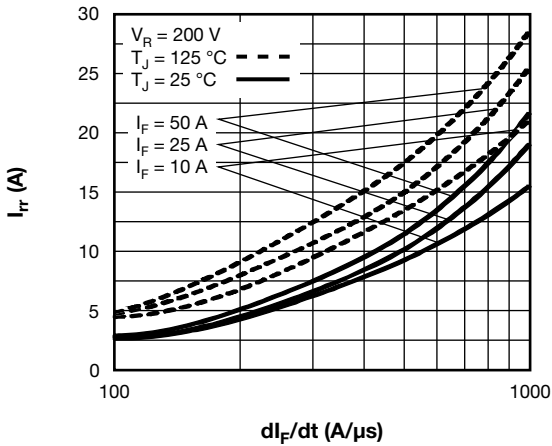

Fig. 6 - Typical Recovery Current vs. di_F/dt

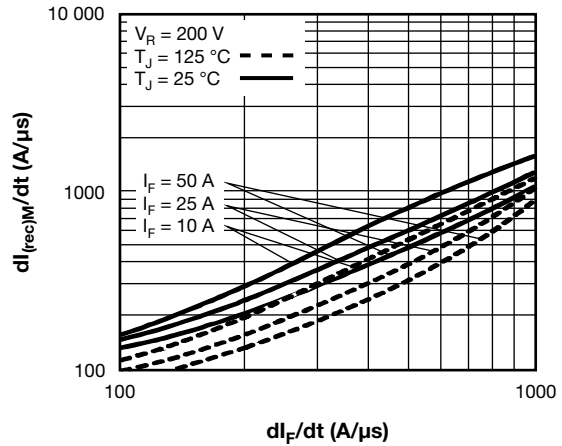

Fig. 8 - Typical $di_{(rec)M}/dt$ vs. di_F/dt

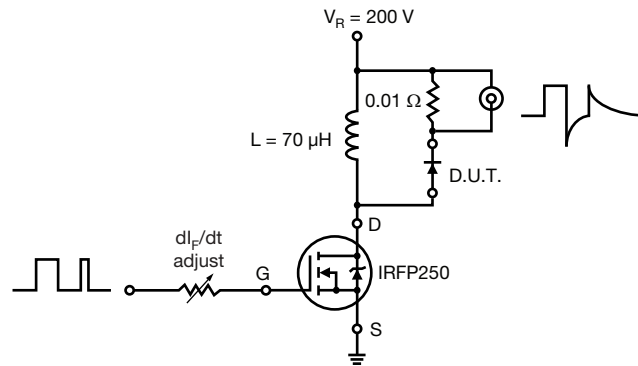
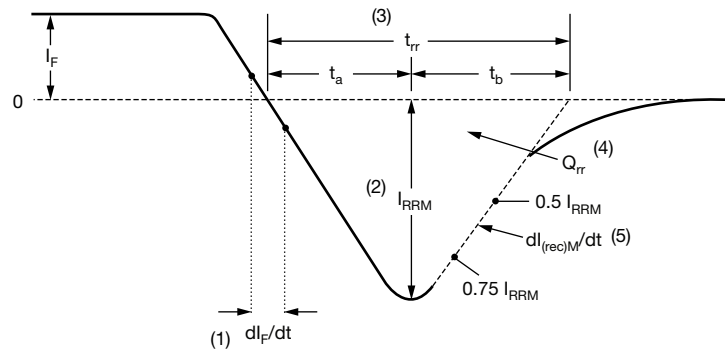

Fig. 9 - Reverse Recovery Parameter Test Circuit



- (1) dI_F/dt - rate of change of current through zero crossing
- (2) I_{RRM} - peak reverse recovery current
- (3) t_{rr} - reverse recovery time measured from zero crossing point of negative going I_F to point where a line passing through $0.75 I_{RRM}$ and $0.50 I_{RRM}$ extrapolated to zero current.
- (4) Q_{rr} - area under curve defined by t_{rr} and I_{RRM}
- (5) $dI_{(rec)M}/dt$ - peak rate of change of current during t_b portion of t_{rr}

$$Q_{rr} = \frac{t_{rr} \times I_{RRM}}{2}$$

Fig. 10 - Reverse Recovery Waveform and Definitions



ORDERING INFORMATION TABLE

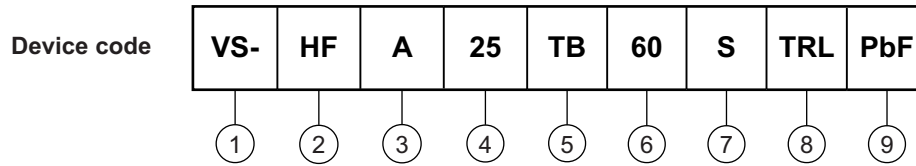

- 1** - Vishay Semiconductors product
- 2** - HEXFRED® family
- 3** - Process designator: A = electron irradiated
- 4** - Current rating (25 = 25 A)
- 5** - Package outline (TB = TO-220, 2 leads)
- 6** - Voltage rating (60 = 600 V)
- 7** - S = D²PAK
- 8** -
 - None = tube
 - TRL = tape and reel (left oriented)
 - TRR = tape and reel (right oriented)
- 9** -
 - PbF = lead (Pb)-free, for tube packaged
 - P = lead (Pb)-free, for tape and reel packaged

ORDERING INFORMATION (Example)			
PREFERRED P/N	QUANTITY PER TUBE	MINIMUM ORDER QUANTITY	PACKAGING DESCRIPTION
VS-HFA25TB60SPBF	50	1000	Antistatic plastic tube
VS-HFA25TB60STRRP	800	800	13" diameter reel
VS-HFA25TB60STRLP	800	800	13" diameter reel

LINKS TO RELATED DOCUMENTS	
Dimensions	www.vishay.com/doc?95046
Part marking information	www.vishay.com/doc?95054
Packaging information	www.vishay.com/doc?95032

D²PAK

DIMENSIONS in millimeters and inches

Conforms to JEDEC® outline D²PAK (SMD-220)

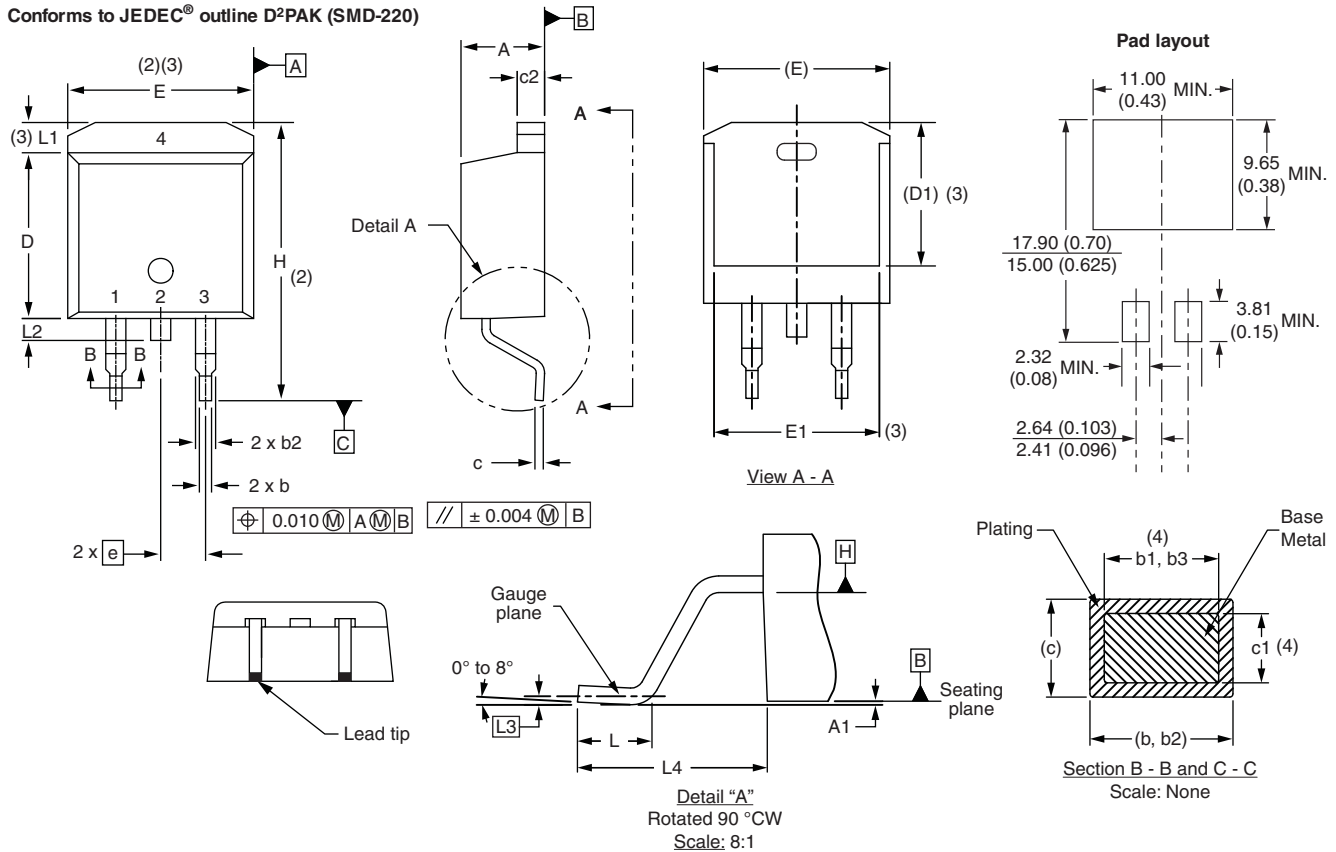

SYMBOL	MILLIMETERS		INCHES		NOTES	SYMBOL	MILLIMETERS		INCHES		NOTES
	MIN.	MAX.	MIN.	MAX.			MIN.	MAX.	MIN.	MAX.	
A	4.06	4.83	0.160	0.190		D1	6.86	8.00	0.270	0.315	3
A1	0.00	0.254	0.000	0.010		E	9.65	10.67	0.380	0.420	2, 3
b	0.51	0.99	0.020	0.039		E1	7.90	8.80	0.311	0.346	3
b1	0.51	0.89	0.020	0.035	4	e	2.54 BSC		0.100 BSC		
b2	1.14	1.78	0.045	0.070		H	14.61	15.88	0.575	0.625	
b3	1.14	1.73	0.045	0.068	4	L	1.78	2.79	0.070	0.110	
c	0.38	0.74	0.015	0.029		L1	-	1.65	-	0.066	3
c1	0.38	0.58	0.015	0.023	4	L2	1.27	1.78	0.050	0.070	
c2	1.14	1.65	0.045	0.065		L3	0.25 BSC		0.010 BSC		
D	8.51	9.65	0.335	0.380	2	L4	4.78	5.28	0.188	0.208	

Notes

- Dimensioning and tolerancing per ASME Y14.5 M-1994
- Dimension D and E do not include mold flash. Mold flash shall not exceed 0.127 mm (0.005") per side. These dimensions are measured at the outmost extremes of the plastic body
- Thermal pad contour optional within dimension E, L1, D1 and E1
- Dimension b1 and c1 apply to base metal only
- Datum A and B to be determined at datum plane H
- Controlling dimension: inch
- Outline conforms to JEDEC® outline TO-263AB



Disclaimer

ALL PRODUCT, PRODUCT SPECIFICATIONS AND DATA ARE SUBJECT TO CHANGE WITHOUT NOTICE TO IMPROVE RELIABILITY, FUNCTION OR DESIGN OR OTHERWISE.

Vishay Intertechnology, Inc., its affiliates, agents, and employees, and all persons acting on its or their behalf (collectively, "Vishay"), disclaim any and all liability for any errors, inaccuracies or incompleteness contained in any datasheet or in any other disclosure relating to any product.

Vishay makes no warranty, representation or guarantee regarding the suitability of the products for any particular purpose or the continuing production of any product. To the maximum extent permitted by applicable law, Vishay disclaims (i) any and all liability arising out of the application or use of any product, (ii) any and all liability, including without limitation special, consequential or incidental damages, and (iii) any and all implied warranties, including warranties of fitness for particular purpose, non-infringement and merchantability.

Statements regarding the suitability of products for certain types of applications are based on Vishay's knowledge of typical requirements that are often placed on Vishay products in generic applications. Such statements are not binding statements about the suitability of products for a particular application. It is the customer's responsibility to validate that a particular product with the properties described in the product specification is suitable for use in a particular application. Parameters provided in datasheets and / or specifications may vary in different applications and performance may vary over time. All operating parameters, including typical parameters, must be validated for each customer application by the customer's technical experts. Product specifications do not expand or otherwise modify Vishay's terms and conditions of purchase, including but not limited to the warranty expressed therein.

Except as expressly indicated in writing, Vishay products are not designed for use in medical, life-saving, or life-sustaining applications or for any other application in which the failure of the Vishay product could result in personal injury or death. Customers using or selling Vishay products not expressly indicated for use in such applications do so at their own risk. Please contact authorized Vishay personnel to obtain written terms and conditions regarding products designed for such applications.

No license, express or implied, by estoppel or otherwise, to any intellectual property rights is granted by this document or by any conduct of Vishay. Product names and markings noted herein may be trademarks of their respective owners.