

TPS54426EVM-608 4-A, SWIFT™ Regulator Evaluation Module

Contents

1	Introduction	2
	1.1 Background	2
	1.2 Performance Specification Summary	2
	1.3 Modifications	3
2	Test Setup and Results	3
	2.1 Input / Output Connections	3
	2.2 Start Up Procedure	4
	2.3 Efficiency	4
	2.4 Light Load Efficiency	5
	2.5 Load Regulation	6
	2.6 Line Regulation	7
	2.7 Load Transient Response	8
	2.8 Output Voltage Ripple	8
	2.9 Input Voltage Ripple	9
	2.10 Start Up	9
3	Board Layout	10
	3.1 Layout	10
4	Schematic, Bill of Materials and Reference	14
	4.1 Schematic	14
	4.2 Bill of Materials	14
	4.3 Reference	14

List of Figures

1	TPS54426EVM-608 Efficiency	4
2	TPS54426EVM-608 Light Load Efficiency.....	5
3	TPS54426EVM-608 Load Regulation	6
4	TPS54426EVM-608 Line Regulation.....	7
5	TPS54426EVM-608 Load Transient Response.....	8
6	TPS54426EVM-608 Output Voltage Ripple	8
7	TPS54426EVM-608 Input Voltage Ripple	9
8	TPS54426EVM-608 Start Up.....	9
9	TPS54426EVM-608 Start Up Relative to Enable	10
10	Top Assembly.....	11
11	Top Layer.....	11
12	Internal Layer 1	12
13	Internal Layer 2	12
14	Bottom Layer as Seen from Back Side.....	13
15	Bottom Assembly as Seen from Back Side	13
16	TPS54426EVM-608 Schematic Diagram.....	14

SWIFT, D-CAP2, Eco-mode are trademarks of Texas Instruments.

List of Tables

1	Input Voltage and Output Current Summary	2
2	TPS54426 EVM and Performance Specifications Summary	2
3	Output Voltages	3
4	Connection and Test Points	4
5	Bill of Materials.....	14

1 Introduction

This user's guide contains background information for the TPS54426 as well as support documentation for the TPS54426EVM-608 evaluation module. Also included are the performance specifications, schematic and the bill of materials for the TPS54426EVM-608.

1.1 Background

The TPS54426 is a single, adaptive on-time D-CAP2™ mode synchronous buck converter requiring a very low external component count. The D-CAP2™ control circuit is optimized for low ESR output capacitors such as POSCAP, SP-CAP or ceramic types and features fast transient response with no external compensation. The switching frequency is internally set at a nominal 700 kHz. The high-side and low-side switching MOSFETs are incorporated inside the TPS54426 package along with the gate drive circuitry. The low drain-to-source on resistance of the MOSFETs allow the TPS54426 to achieve high efficiencies and helps keep the junction temperature low at high output currents. The TPS54426 also has an auto-skip Eco-mode™ to enable higher efficiency at light loads. The TPS54426 dc/dc synchronous converter is designed to provide up to a 4-A output from an input voltage source of 4.5V to 18V. The output voltage range is from 0.76V to 5.5V. voltage and output current range for the evaluation module are given in [Table 1](#).

Table 1. Input Voltage and Output Current Summary

EVM	Input Voltage Range	Output Voltage and Current Range
TPS54426EVM-608	VIN = 4.5V to 18V	VOUT = 1.05 V, 0A to 4A

1.2 Performance Specification Summary

A summary of the TPS54426EVM-608 performance specifications is provided in [Table 2](#). Specifications are given for an input voltage of VIN = 12V and an output voltage of 1.05V, unless otherwise noted. The ambient temperature is 25°C for all measurement, unless otherwise noted.

Table 2. TPS54426 EVM and Performance Specifications Summary

Specifications		Test Conditions	Min	Typ	Max	Unit
Input voltage range (VIN)			4.5	12	18	V
CH1	Output voltage			1.05		V
	Operating frequency	VIN = 12V, IO = 1 A		675		kHz
	Output current range		0		4	A
	Over current limit	VIN = 12V, LO = 1.5 μH		5.4		A
	Output ripple voltage	VIN = 12V, IO = 4 A			7	mVPP

1.3 Modifications

These evaluation modules are designed to provide access to the feature of the TPS54426. Some modification can be made to this module.

1.3.1 Output Voltage Set Point

To change the output voltage of the EVMs, it is necessary to change the value of resistor R1. Changing the value of R1 can change the output voltage above 0.765V. The value of R1 for a specific output voltage can be calculated using [Equation 1](#) and [Equation 2](#).

For output voltage from 0.76V to 2.5V:

$$V_O = 0.765 \times \left(1 + \frac{R1}{R2}\right) \quad (1)$$

For output voltage over 2.5V:

$$V_O = (0.763 + 0.0017 \times V_O) \times \left(1 + \frac{R1}{R2}\right) \quad (2)$$

[Table 3](#) lists the R1 value for some common output voltages. For higher output voltages of 1.8 V or above, a feed forward capacitor (C2) may be required to improve phase margin, and is recommended for auto skip Eco-mode™ stability. Pads for this component (C2) are provided on the printed circuit board. Note that the values given in [Table 3](#) are standard values, and not the exact value calculated using [Table 3](#).

Table 3. Output Voltages

Output Voltage (V)	R1 (kΩ)	R2 (kΩ)	C2 (pF)	L1 (μH)
1.0	6.81	22.1		1.5
1.05	8.25	22.1		1.5
1.2	12.7	22.1		1.5
1.8	30.1	22.1	10 - 22	2.2
2.5	49.9	22.1	10 - 22	2.2
3.3	73.2	22.1	10 - 22	2.2
5.0	121	22.1	10 - 22	3.3

2 Test Setup and Results

This section describes how to properly connect, set up, and use the TPS54426EVM-608. The section also includes test results typical for the evaluation modules and efficiency, output load regulation, output line regulation, load transient response, output voltage ripple, input voltage ripple, start up and switching frequency.

2.1 Input / Output Connections

The TPS54426EVM-608 is provided with input/output connectors and test points as shown in [Table 4](#). A power supply capable of supplying 2 A must be connected to J1 through a pair of 20 AWG wires. The load must be connected to J2 through a pair of 20 AWG wires. The maximum load current capability is 4 A. Wire lengths must be minimized to reduce losses in the wires. Test point TP1 provides a place to monitor the V_{IN} input voltages with TP2 providing a convenient ground reference. TP8 is used to monitor the output voltage with TP9 as the ground reference.

Table 4. Connection and Test Points

Reference Designator	Function
J1	V_{IN} (see Table 1 for V_{IN} range)
J2	V_{OUT} , 1.05 V at 4 A maximum
JP1	EN control. Connect EN to OFF to disable, connect EN to ON to enable.
TP1	V_{IN} test point at V_{IN} connector
TP2	GND test point at V_{IN}
TP3	EN test point
TP4	Analog ground test point
TP5	Switch node test point
TP6	Power good test point
TP7	Output voltage test point
TP8	Ground test point at output connector

2.2 Start Up Procedure

1. Make sure the jumper at JP1 (Enable control) is set from EN to OFF.
2. Apply appropriate V_{IN} voltage to V_{IN} and PGND terminals at J1.
3. Move the jumper at JP1 (Enable control) to cover EN and ON. The EVM will enable the output voltage.

2.3 Efficiency

Figure 1 shows the efficiency for the TPS54426EVM-608 at an ambient temperature of 25°C.

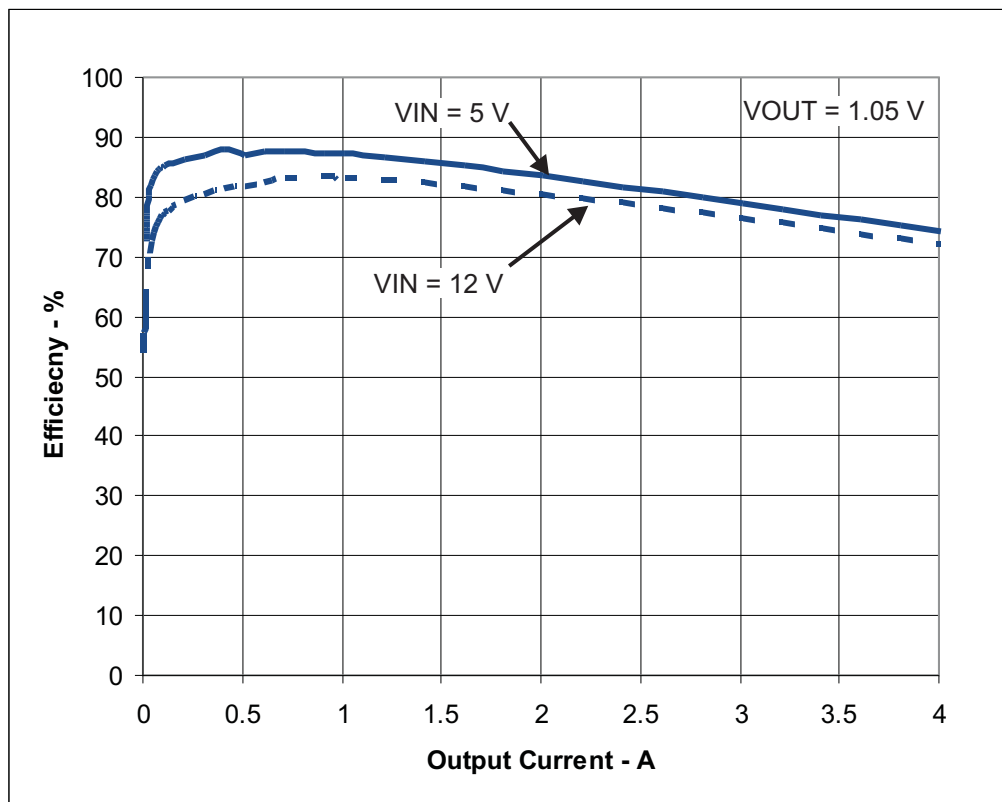

Figure 1. TPS54426EVM-608 Efficiency

2.4 Light Load Efficiency

Figure 2 shows the efficiency at light loads for the TPS54426EVM-608 at an ambient temperature of 25°C.

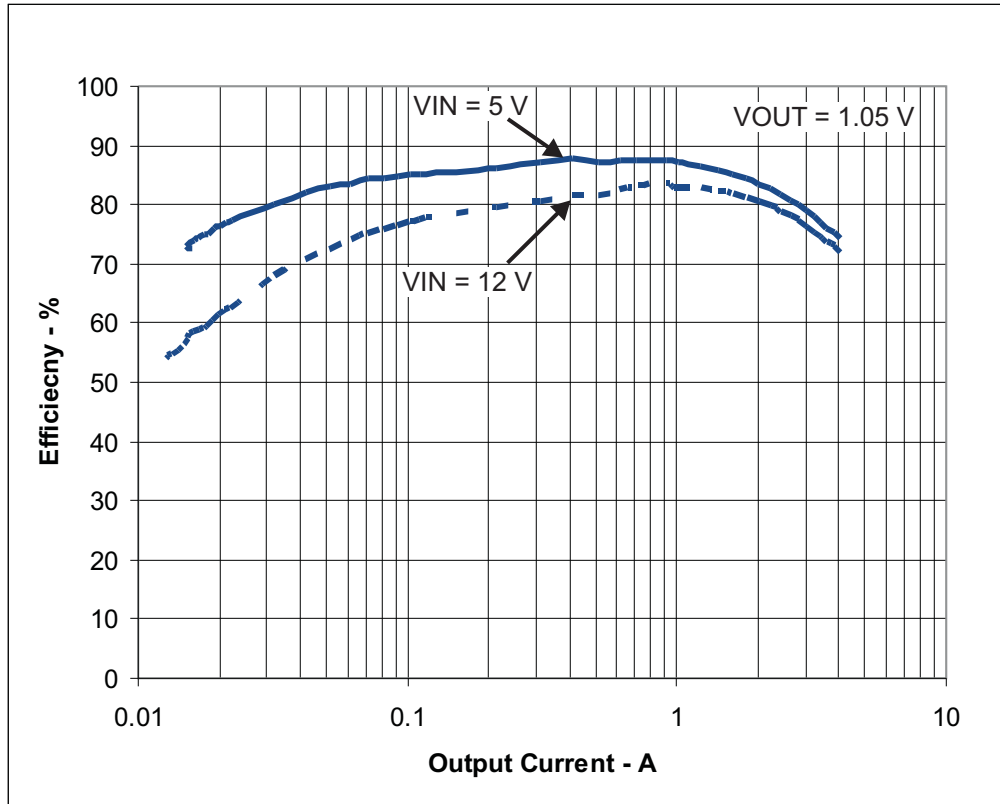

Figure 2. TPS54426EVM-608 Light Load Efficiency

2.5 Load Regulation

The load regulation for the TPS54426EVM-608 is shown [Figure 3](#).

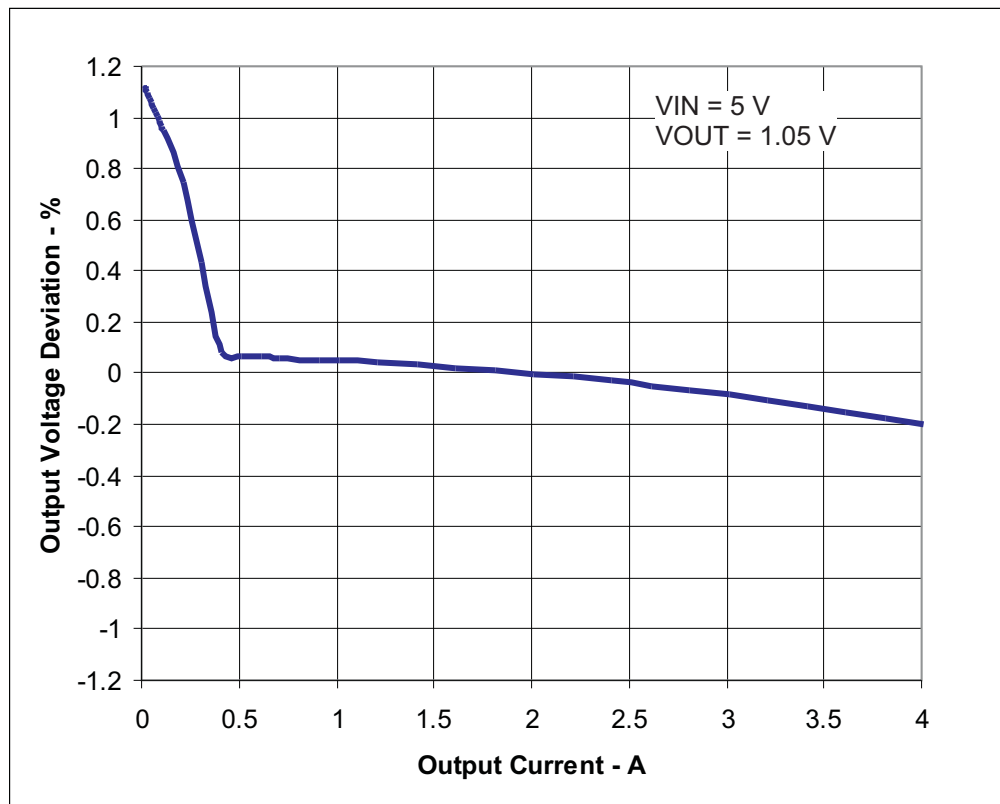

Figure 3. TPS54426EVM-608 Load Regulation

2.6 Line Regulation

The line regulation for the TPS54426EVM-608 is shown [Figure 4](#).

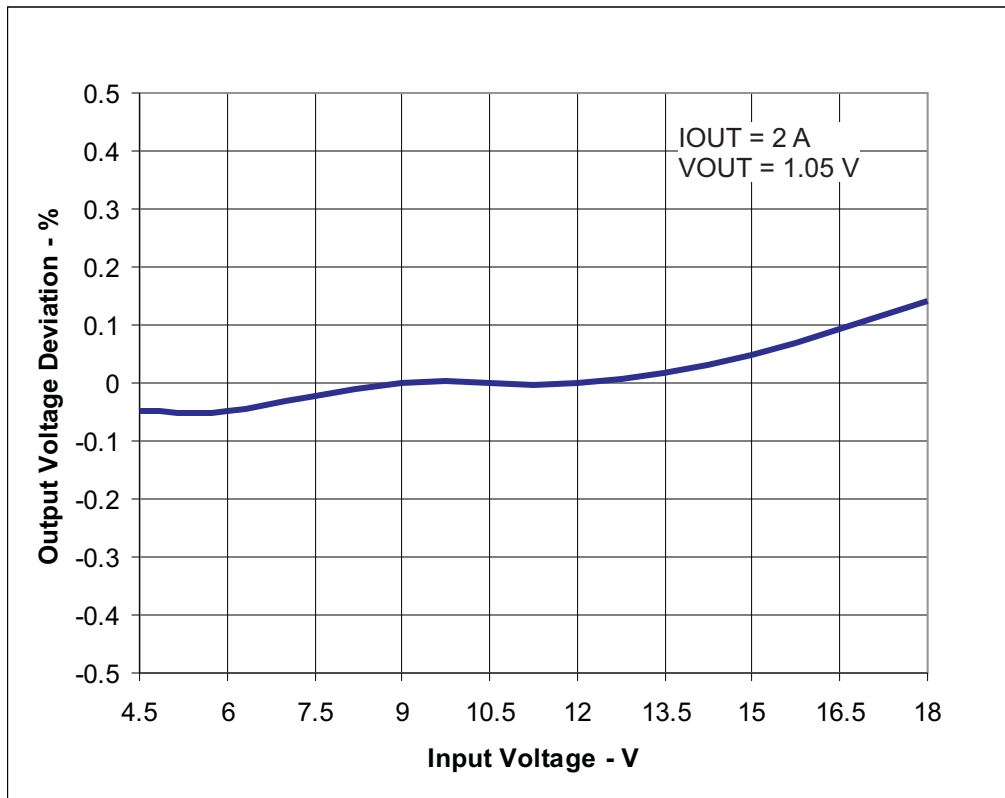

Figure 4. TPS54426EVM-608 Line Regulation

2.7 Load Transient Response

The TPS54426EVM-608 response to load transient is shown in Figure 5. The current step is from 500 mA to 1.5 A (25% to 75% of rated load). Total peak-to-peak output voltage variation is as shown.

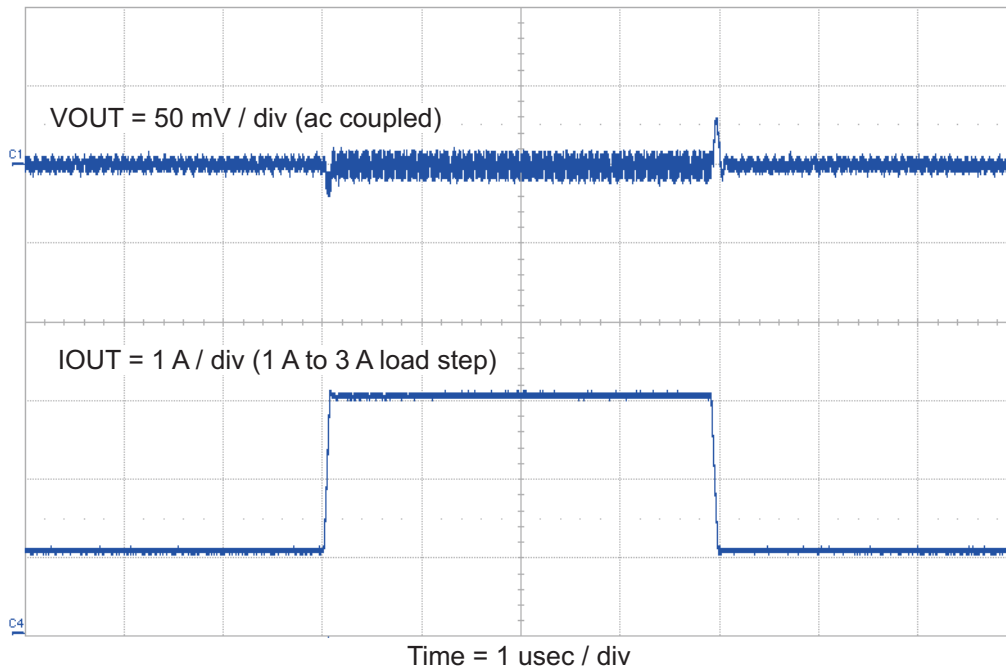

Figure 5. TPS54426EVM-608 Load Transient Response

2.8 Output Voltage Ripple

The TPS54426EVM-608 output voltage ripple is shown in Figure 6. The output current is the rated full load of 2A.

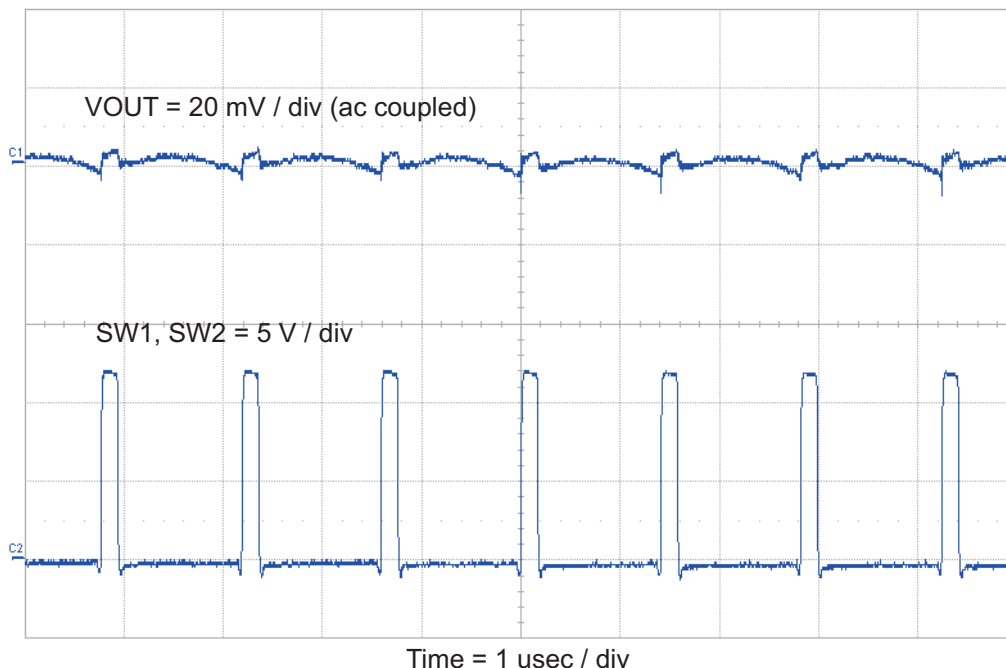

Figure 6. TPS54426EVM-608 Output Voltage Ripple

2.9 Input Voltage Ripple

The TPS54426EVM-608 input voltage ripple is shown in [Figure 7](#). The output current is the rated full load of 2A.

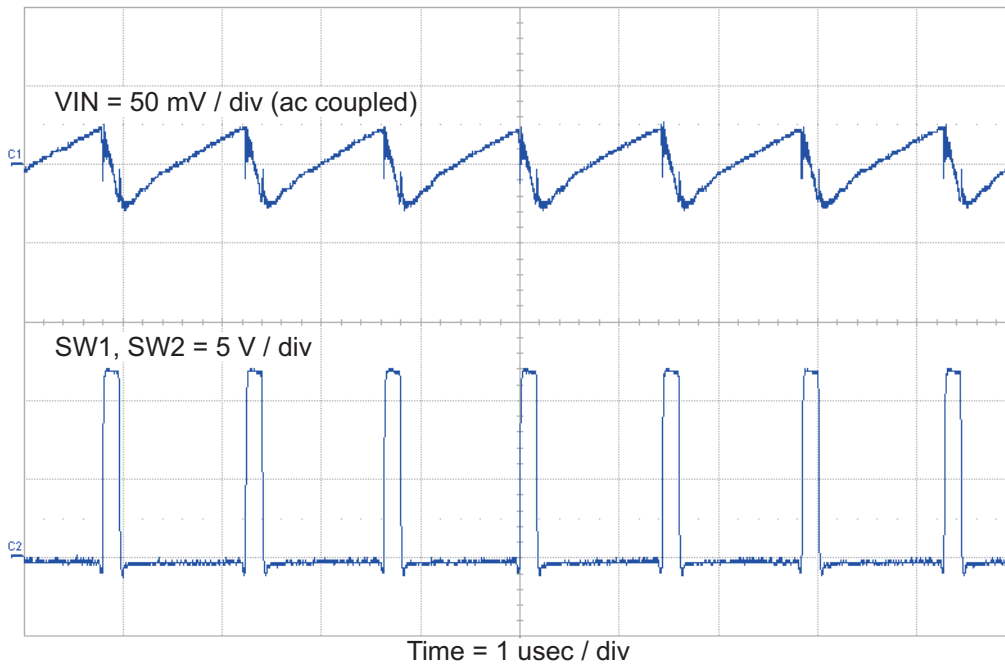

Figure 7. TPS54426EVM-608 Input Voltage Ripple

2.10 Start Up

The TPS54426EVM-608 start up waveform relative to V_{IN} is shown in [Figure 8](#).

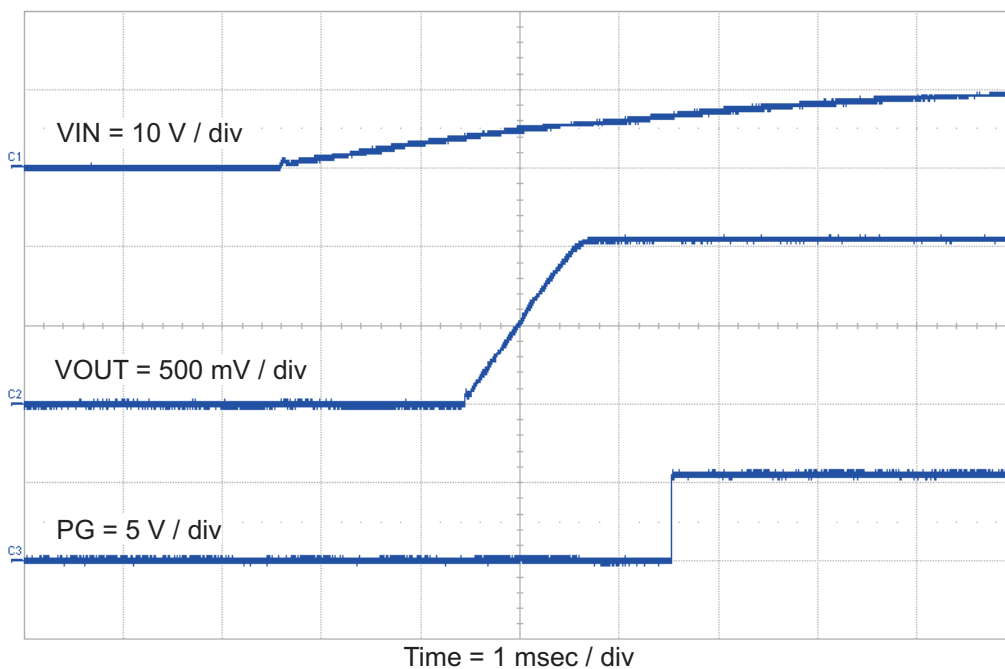

Figure 8. TPS54426EVM-608 Start Up

The TPS54426EVM-608 start up waveform relative to enable (EN) is shown in [Figure 9](#).

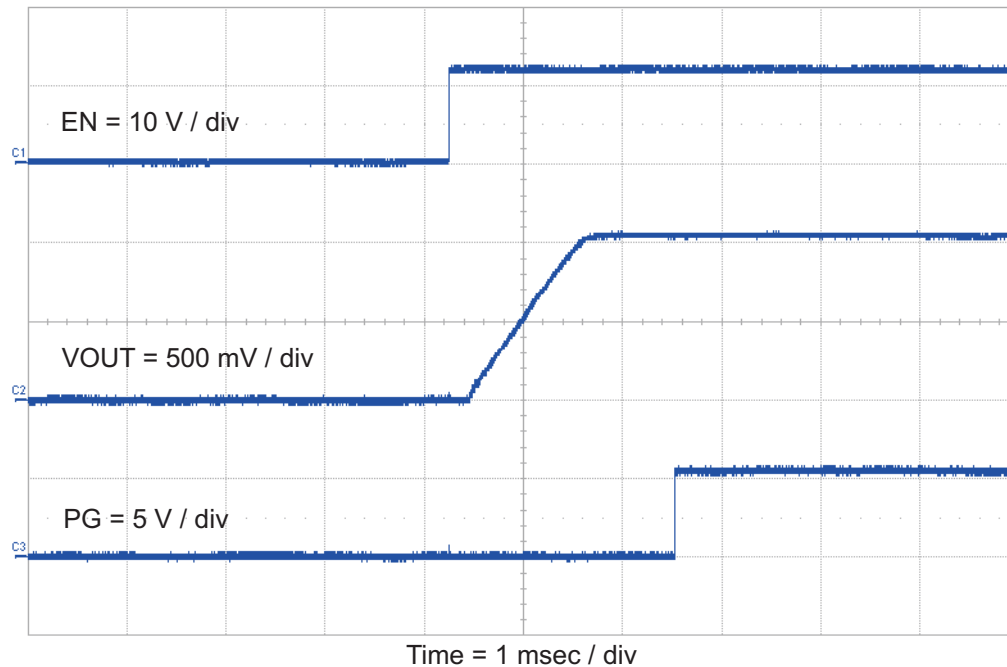

Figure 9. TPS54426EVM-608 Start Up Relative to Enable

3 Board Layout

This section provides description of the TPS54426EVM-608, board layout, and layer illustrations.

3.1 Layout

The board layout for the TPS54426EVM-608 and is shown in [Figure 10](#) through [Figure 15](#). The top layer contains the main power traces for VIN, VO and ground. Also on the top layer are connections for the pins of the TPS54426 and a large area filled with ground. Many of the signal traces are also located on the top side. The input decoupling capacitor are located as close to the IC as possible. The input and output connectors, test points and most of the components are located on the top side. R3, the 0-Ω resistor that connects VIN to VCC and R4, the power good pull up, are located on the back side. Analog ground and power ground are connected at a single point on the top layer near pin 5 of the TPS54426. The internal layer 1 is a split plane containing analog and power grounds. The internal layer 2 is primarily power ground. There are also a fill area of VIN and a trace routing VCC to the enable control jumper JP1. The bottom layer is primarily analog ground. There are also traces to connect VIN to VCC through R3, traces for the power good signal and the feedback trace from VOUT to the voltage setpoint divider network.

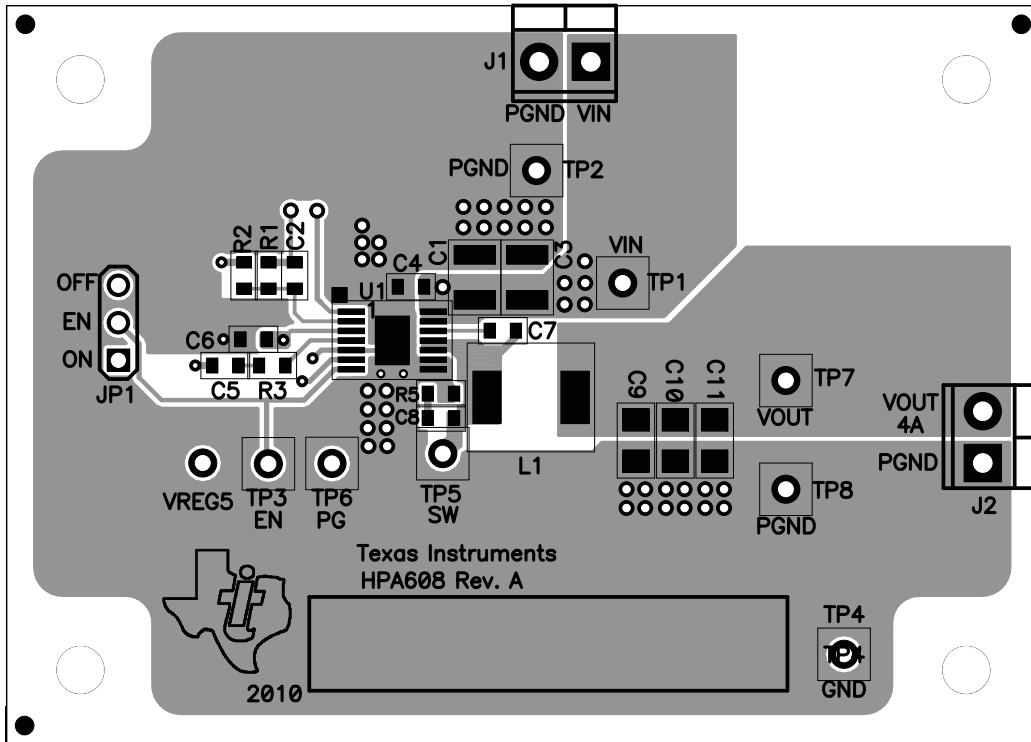

Figure 10. Top Assembly

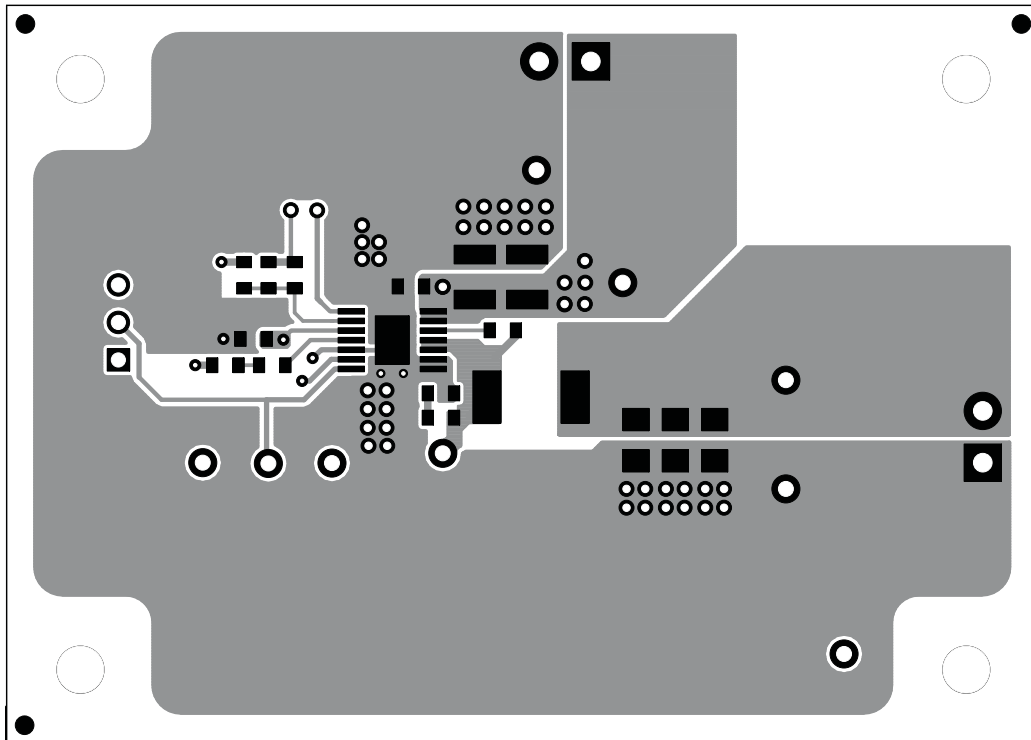

Figure 11. Top Layer

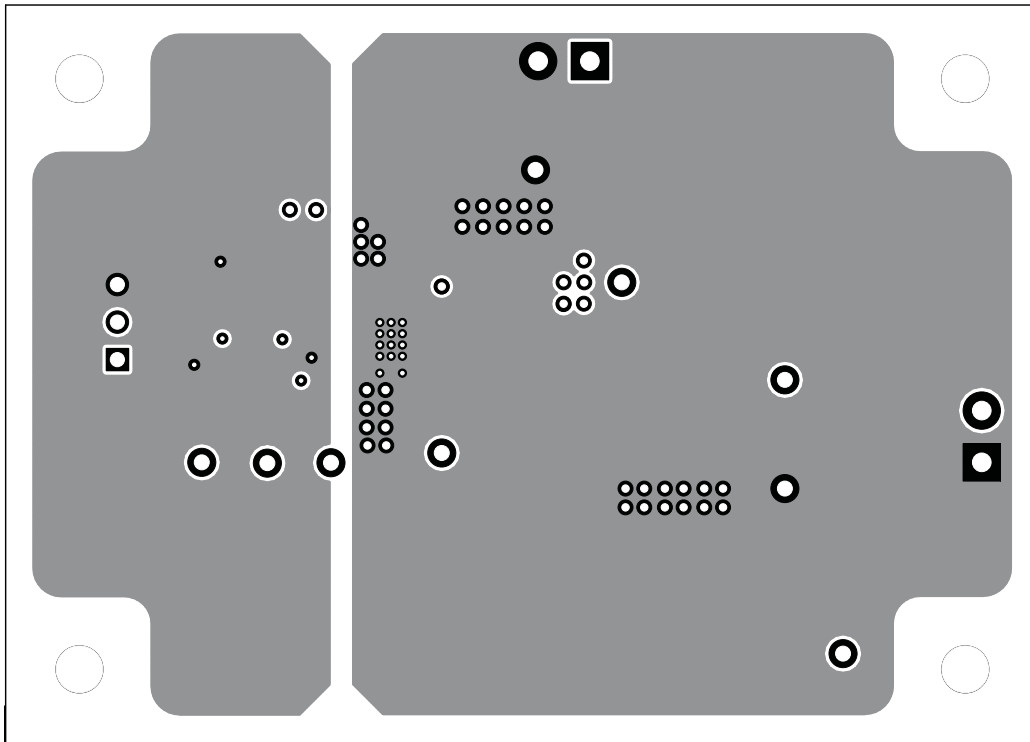

Figure 12. Internal Layer 1

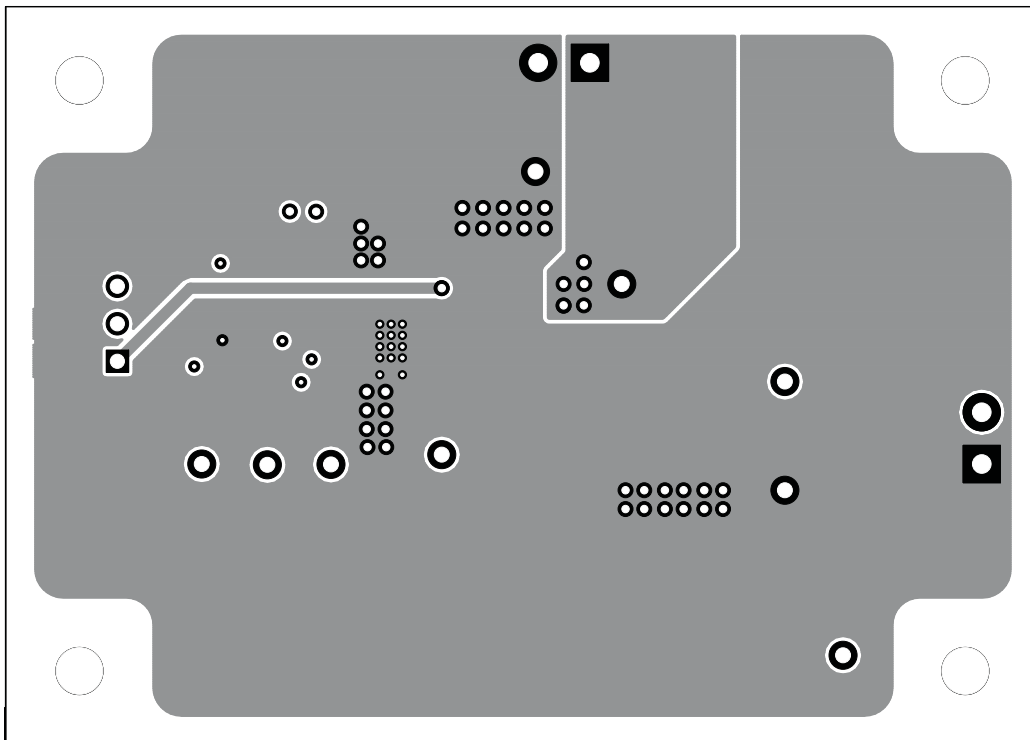

Figure 13. Internal Layer 2

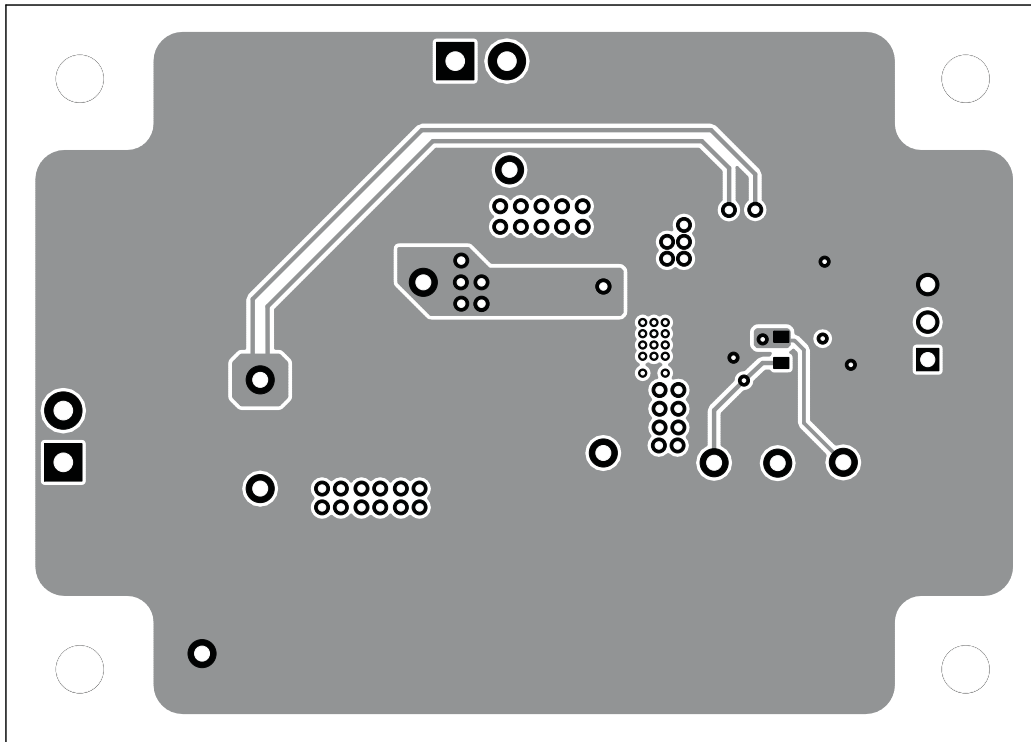

Figure 14. Bottom Layer as Seen from Back Side

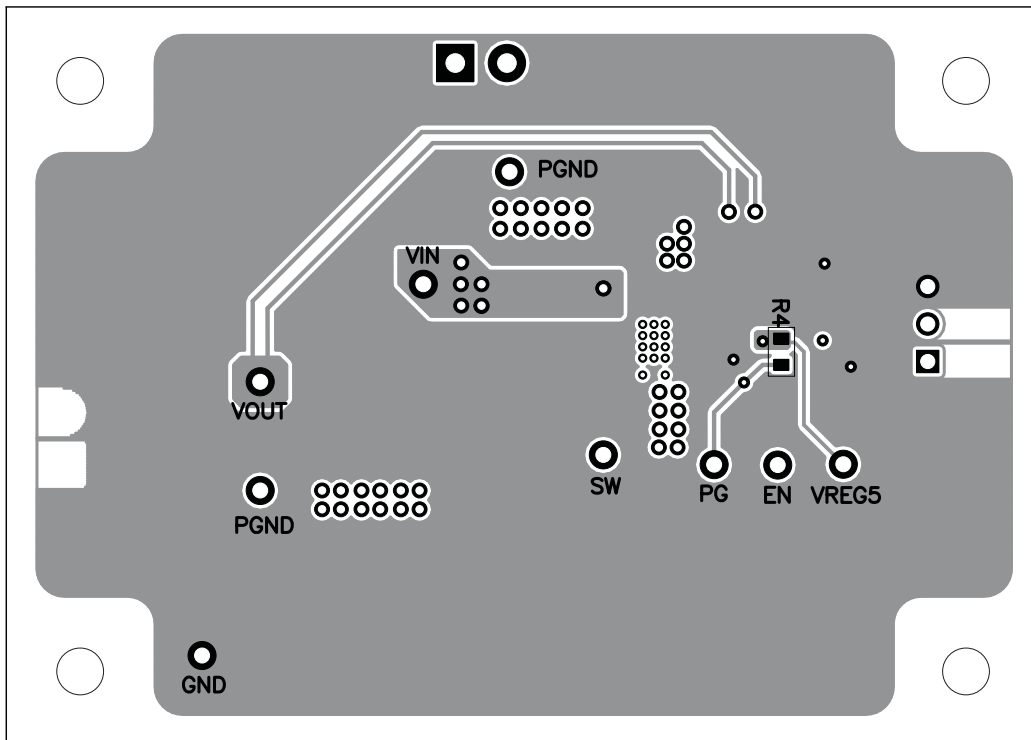

Figure 15. Bottom Assembly as Seen from Back Side

4 Schematic, Bill of Materials and Reference

This section presents the TPS54426EVM-608 schematic, bill of materials and reference.

4.1 Schematic

Figure 16 is the schematic for the TPS54426EVM.

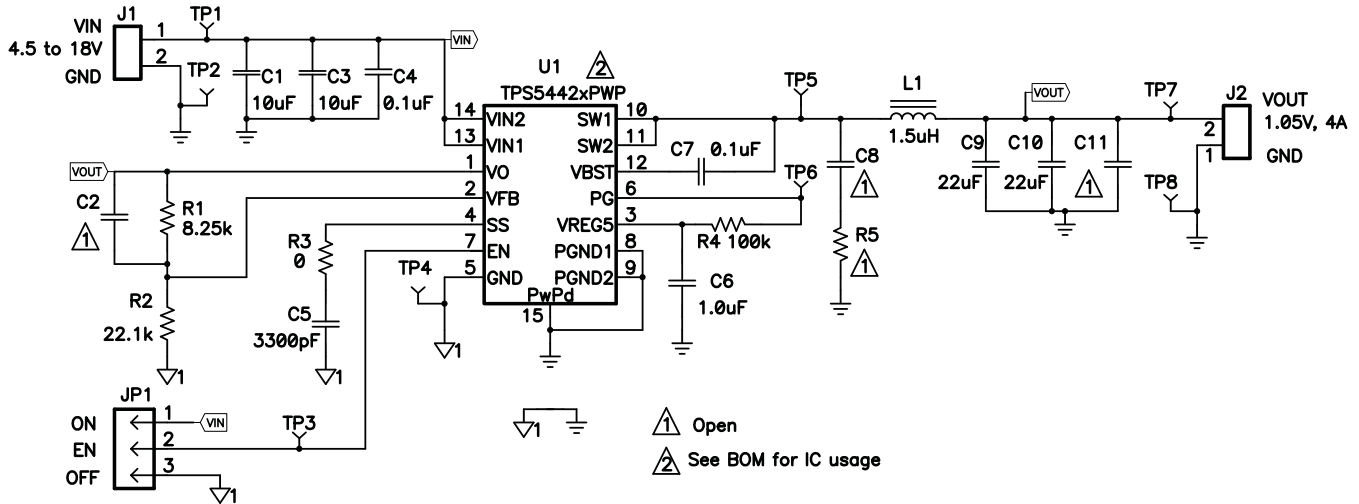

Figure 16. TPS54426EVM-608 Schematic Diagram

4.2 Bill of Materials

Table 5. Bill of Materials

RefDes	QTY	Value	Description	Size	Part Number	MFR
C1, C3	2	10uF	Capacitor, Ceramic, 25V, X5R, 20%	1210	C3225X5R1E106M	TDK
C11	0	Open	Capacitor, Ceramic	1206	Std	Std
C2, C8	0	Open	Capacitor, Ceramic	0603	Std	Std
C4, C7	2	0.1uF	Capacitor, Ceramic, 50V, X7R, 10%			
C5	1	3300pF	Capacitor, Ceramic, 25V, X7R, 10%	0603	Std	Std
C6	1	1.0uF	Capacitor, Ceramic, 16V, X7R, 10%	0603	Std	Std
C9, C10	2	22uF	Capacitor, Ceramic, 6.3V, X5R, 20%	1206	C3216X5R0J226M	TDK
J1, J2	2	ED555/2DS	Terminal Block, 2-pin, 6-A, 3.5mm	0.27 x 0.25 inch	ED555/2DS	Sullins
JP1	1	PEC03SAAN	Header, Male 3-pin, 100mil spacing	0.100 inch x 3	PEC03SAAN	Sullins
L1	1	1.5uH	Inductor, SMT, 11A, 9.7 milliohm	0.256 x 0.280 inch	SPM6530T-1R5M100	TDK
R1	1	8.25k	Resistor, Chip, 1/16W, 1%	0603	Std	Std
R2	1	22.1k	Resistor, Chip, 1/16W, 1%	0603	Std	Std
R3	1	0	Resistor, Chip, 1/16W, 1%	0603	Std	Std
R4	1	100k	Resistor, Chip, 1/16W, 1%	0603	Std	Std
R5	0	Open	Resistor, Chip, 1/16W, 1%	0603	Std	Std
TP1, TP3, TP5, TP6, TP7	5	5000	Test Point, Red, Thru Hole Color Keyed	0.100 x 0.100 inch	5000	Keystone
TP2, TP5, TP8	3	5001	Test Point, Black, Thru Hole Color Keyed	0.100 x 0.100 inch	5001	Keystone
U1	1	TPS54426PWP	IC, 4-A Output Single Sync. Step-Down		TPS54426PWP	TI
-	1		Shunt, 100-mil, Black	0.100	929950-00	3M
-	1		PCB, 2.76 In x 1.97 In x 0.062 In		HPA608	Any

4.3 Reference

1. TPS54426 data sheet, *Single Synchronous Converter with Integrated High Side and Low Side MOS FET* ([SLVSAD6](#))

Evaluation Board/Kit Important Notice

Texas Instruments (TI) provides the enclosed product(s) under the following conditions:

This evaluation board/kit is intended for use for **ENGINEERING DEVELOPMENT, DEMONSTRATION, OR EVALUATION PURPOSES ONLY** and is not considered by TI to be a finished end-product fit for general consumer use. Persons handling the product(s) must have electronics training and observe good engineering practice standards. As such, the goods being provided are not intended to be complete in terms of required design-, marketing-, and/or manufacturing-related protective considerations, including product safety and environmental measures typically found in end products that incorporate such semiconductor components or circuit boards. This evaluation board/kit does not fall within the scope of the European Union directives regarding electromagnetic compatibility, restricted substances (RoHS), recycling (WEEE), FCC, CE or UL, and therefore may not meet the technical requirements of these directives or other related directives.

Should this evaluation board/kit not meet the specifications indicated in the User's Guide, the board/kit may be returned within 30 days from the date of delivery for a full refund. **THE FOREGOING WARRANTY IS THE EXCLUSIVE WARRANTY MADE BY SELLER TO BUYER AND IS IN LIEU OF ALL OTHER WARRANTIES, EXPRESSED, IMPLIED, OR STATUTORY, INCLUDING ANY WARRANTY OF MERCHANTABILITY OR FITNESS FOR ANY PARTICULAR PURPOSE.**

The user assumes all responsibility and liability for proper and safe handling of the goods. Further, the user indemnifies TI from all claims arising from the handling or use of the goods. Due to the open construction of the product, it is the user's responsibility to take any and all appropriate precautions with regard to electrostatic discharge.

EXCEPT TO THE EXTENT OF THE INDEMNITY SET FORTH ABOVE, NEITHER PARTY SHALL BE LIABLE TO THE OTHER FOR ANY INDIRECT, SPECIAL, INCIDENTAL, OR CONSEQUENTIAL DAMAGES.

TI currently deals with a variety of customers for products, and therefore our arrangement with the user **is not exclusive.**

TI assumes **no liability for applications assistance, customer product design, software performance, or infringement of patents or services described herein.**

Please read the User's Guide and, specifically, the Warnings and Restrictions notice in the User's Guide prior to handling the product. This notice contains important safety information about temperatures and voltages. For additional information on TI's environmental and/or safety programs, please contact the TI application engineer or visit www.ti.com/esh.

No license is granted under any patent right or other intellectual property right of TI covering or relating to any machine, process, or combination in which such TI products or services might be or are used.

FCC Warning

This evaluation board/kit is intended for use for **ENGINEERING DEVELOPMENT, DEMONSTRATION, OR EVALUATION PURPOSES ONLY** and is not considered by TI to be a finished end-product fit for general consumer use. It generates, uses, and can radiate radio frequency energy and has not been tested for compliance with the limits of computing devices pursuant to part 15 of FCC rules, which are designed to provide reasonable protection against radio frequency interference. Operation of this equipment in other environments may cause interference with radio communications, in which case the user at his own expense will be required to take whatever measures may be required to correct this interference.

EVM Warnings and Restrictions

It is important to operate this EVM within the input voltage range of 5V to 17V and the output voltage range of 1V to 5V .

Exceeding the specified input range may cause unexpected operation and/or irreversible damage to the EVM. If there are questions concerning the input range, please contact a TI field representative prior to connecting the input power.

Applying loads outside of the specified output range may result in unintended operation and/or possible permanent damage to the EVM. Please consult the EVM User's Guide prior to connecting any load to the EVM output. If there is uncertainty as to the load specification, please contact a TI field representative.

During normal operation, some circuit components may have case temperatures greater than 85°C. The EVM is designed to operate properly with certain components above 85°C as long as the input and output ranges are maintained. These components include but are not limited to linear regulators, switching transistors, pass transistors, and current sense resistors. These types of devices can be identified using the EVM schematic located in the EVM User's Guide. When placing measurement probes near these devices during operation, please be aware that these devices may be very warm to the touch.

Mailing Address: Texas Instruments, Post Office Box 655303, Dallas, Texas 75265
Copyright © 2010, Texas Instruments Incorporated

IMPORTANT NOTICE

Texas Instruments Incorporated and its subsidiaries (TI) reserve the right to make corrections, modifications, enhancements, improvements, and other changes to its products and services at any time and to discontinue any product or service without notice. Customers should obtain the latest relevant information before placing orders and should verify that such information is current and complete. All products are sold subject to TI's terms and conditions of sale supplied at the time of order acknowledgment.

TI warrants performance of its hardware products to the specifications applicable at the time of sale in accordance with TI's standard warranty. Testing and other quality control techniques are used to the extent TI deems necessary to support this warranty. Except where mandated by government requirements, testing of all parameters of each product is not necessarily performed.

TI assumes no liability for applications assistance or customer product design. Customers are responsible for their products and applications using TI components. To minimize the risks associated with customer products and applications, customers should provide adequate design and operating safeguards.

TI does not warrant or represent that any license, either express or implied, is granted under any TI patent right, copyright, mask work right, or other TI intellectual property right relating to any combination, machine, or process in which TI products or services are used. Information published by TI regarding third-party products or services does not constitute a license from TI to use such products or services or a warranty or endorsement thereof. Use of such information may require a license from a third party under the patents or other intellectual property of the third party, or a license from TI under the patents or other intellectual property of TI.

Reproduction of TI information in TI data books or data sheets is permissible only if reproduction is without alteration and is accompanied by all associated warranties, conditions, limitations, and notices. Reproduction of this information with alteration is an unfair and deceptive business practice. TI is not responsible or liable for such altered documentation. Information of third parties may be subject to additional restrictions.

Resale of TI products or services with statements different from or beyond the parameters stated by TI for that product or service voids all express and any implied warranties for the associated TI product or service and is an unfair and deceptive business practice. TI is not responsible or liable for any such statements.

TI products are not authorized for use in safety-critical applications (such as life support) where a failure of the TI product would reasonably be expected to cause severe personal injury or death, unless officers of the parties have executed an agreement specifically governing such use. Buyers represent that they have all necessary expertise in the safety and regulatory ramifications of their applications, and acknowledge and agree that they are solely responsible for all legal, regulatory and safety-related requirements concerning their products and any use of TI products in such safety-critical applications, notwithstanding any applications-related information or support that may be provided by TI. Further, Buyers must fully indemnify TI and its representatives against any damages arising out of the use of TI products in such safety-critical applications.

TI products are neither designed nor intended for use in military/aerospace applications or environments unless the TI products are specifically designated by TI as military-grade or "enhanced plastic." Only products designated by TI as military-grade meet military specifications. Buyers acknowledge and agree that any such use of TI products which TI has not designated as military-grade is solely at the Buyer's risk, and that they are solely responsible for compliance with all legal and regulatory requirements in connection with such use.

TI products are neither designed nor intended for use in automotive applications or environments unless the specific TI products are designated by TI as compliant with ISO/TS 16949 requirements. Buyers acknowledge and agree that, if they use any non-designated products in automotive applications, TI will not be responsible for any failure to meet such requirements.

Following are URLs where you can obtain information on other Texas Instruments products and application solutions:

Products		Applications	
Amplifiers	amplifier.ti.com	Audio	www.ti.com/audio
Data Converters	dataconverter.ti.com	Automotive	www.ti.com/automotive
DLP® Products	www.dlp.com	Communications and Telecom	www.ti.com/communications
DSP	dsp.ti.com	Computers and Peripherals	www.ti.com/computers
Clocks and Timers	www.ti.com/clocks	Consumer Electronics	www.ti.com/consumer-apps
Interface	interface.ti.com	Energy	www.ti.com/energy
Logic	logic.ti.com	Industrial	www.ti.com/industrial
Power Mgmt	power.ti.com	Medical	www.ti.com/medical
Microcontrollers	microcontroller.ti.com	Security	www.ti.com/security
RFID	www.ti-rfid.com	Space, Avionics & Defense	www.ti.com/space-avionics-defense
RF/IF and ZigBee® Solutions	www.ti.com/lprf	Video and Imaging	www.ti.com/video
		Wireless	www.ti.com/wireless-apps

Mailing Address: Texas Instruments, Post Office Box 655303, Dallas, Texas 75265
Copyright © 2010, Texas Instruments Incorporated