

LM3535

LM3535 Multi-Display LED Driver with Ambient Light Sensing and Dynamic Backlight Control Compatibility



Literature Number: SNVS598

LM3535

Multi-Display LED Driver with Ambient Light Sensing and Dynamic Backlight Control Compatibility

General Description

The LM3535 is a highly integrated LED driver capable of driving 8 LEDs in parallel for large display applications. Independent LED control allows for a subset of the 6 main display LEDs to be selected for partial illumination applications. In addition to the main bank of 6, the LM3535 is capable of driving an additional 2 independently controlled LEDs to support Indicator applications.

The LED driver current sinks are split into three independently controlled groups. The primary group can be configured to drive up to six LEDs for use in the main phone display. Groups B and C are provided for driving secondary displays, keypads and indicator LEDs. All of the LED current sources can be independently turned on and off providing flexibility to address different application requirements.

The LM3535 provides multi-zone Ambient Light Sensing (1 or 2 ALS inputs depending on option) allowing autonomous backlight intensity control in the event of changing ambient light conditions. A PWM input is also provided to give the user a means to adjust the backlight intensity dynamically based upon the content of the display.

The LM3535 provides excellent efficiency without the use of an inductor by operating the charge pump in a gain of 3/2 or in Pass-Mode. The proper gain for maintaining current regulation is chosen, based on LED forward voltage, so that efficiency is maximized over the input voltage range.

The LM3535 is available in National's tiny 20-bump, 0.4mm pitch, thin micro SMD package.

Features

- Drives up to 8 LEDs with up to 25mA of Diode Current Each
- External PWM input for Dynamic Backlight Control
- Multi-Zone Ambient Light Sensing (ALS)
- Dual-ALS Sensor Inputs (LM3535-2ALS only)
- ALS Interrupt Reporting
- Independent On/Off Control for all Current Sinks
- 128 Exponential Dimming Steps with 600:1 Dimming Ratio for Group A (Up to 6 LEDs)
- 8 Linear Dimming States for Groups B (Up to 3 LEDs) and D1C (1 LED)
- Programmable Auto-Dimming Function
- Up to 90% Efficiency
- 0.55% Accurate Current Matching
- Internal Soft-Start Limits Inrush Current
- True Shutdown Isolation for LEDs
- Wide Input Voltage Range (2.7V to 5.5V)
- Active High Hardware Enable
- Total Solution Size < 16mm²
- Low Profile 20 Bump micro SMD Package (1.650mm × 2.055mm × 0.6mm)

Applications

- Smart-Phone LED Backlighting
- Large Format LCD Backlighting
- General LED Lighting

Typical Application Circuit

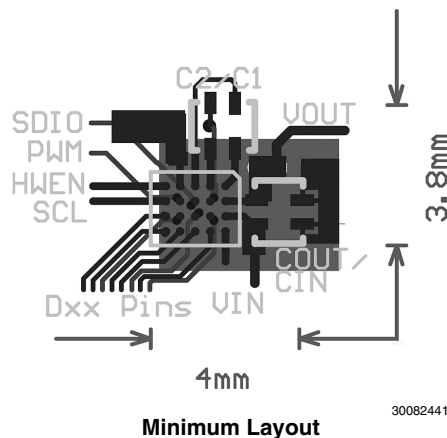
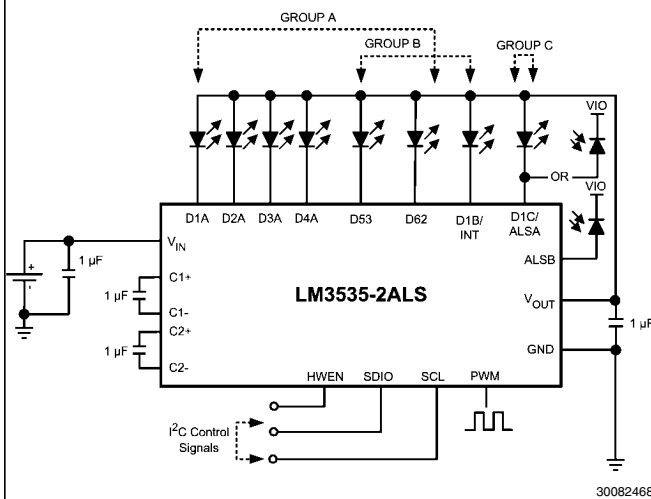

30082441

Connection Diagram

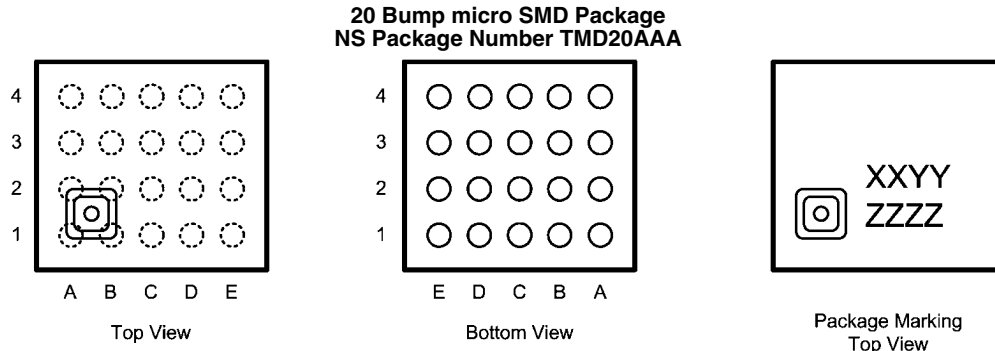

Note: The actual physical placement of the package marking will vary from part to part. The package marking "XX" designates the date code. "YY" is a NSC internal code for die traceability. Both will vary considerably. "ZZZZ" identifies the device (part number, option, etc.).
ZZZZ(LM3535) = 3535, ZZZZ (LM3535-2ALS) = 2ALS

30082469

Pin Descriptions

Bump #s TMD20AAA	Pin Names	Pin Descriptions
A3	V_{IN}	Input voltage. Input range: 2.7V to 5.5V.
A2	V_{OUT}	Charge Pump Output Voltage
A1, C1, B1, B2	C1+, C1-, C2+, C2-	Flying Capacitor Connections
D3, E3, E4, D4	D1A-D4A	LED Drivers - GroupA
C4, B4	D53, D62	LED Drivers - Configurable Current Sinks. Can be assigned to GroupA or GroupB
B3	D1B / INT	LED Driver/ ALS Interrupt - GroupB Current Sink or ALS Interrupt Pin. In ALS Interrupt mode, a pull-up resistor is required. A '0' means a change has occurred, while a '1' means no ALS adjustment has been made.
C3	D1C / ALS	LED Driver / ALS Input - Indicator LED current sink or Ambient Light Sensor Input
D2	PWM	External PWM Input - Allows the current sinks to be turned on and off at a frequency and duty cycle externally controlled. Minimum On-Time Pulse Width = 15 μ sec.
E1	HWEN	Hardware Enable Pin. High = Normal Operation, Low = RESET
C2	SDIO	Serial Data Input/Output Pin
E2	SCL	Serial Clock Pin
A4	GND (LM3535) ALS B (LM3535-2ALS)	Ground for LM3535 or Ambient Light Sensor B for LM3535-2ALS
D1	GND	Ground

Ordering Information

Order Information	Package	Supplied As
LM3535TME	TMD20AAA	250 Units, Tape & Reel
LM3535TMX		3000 Units, Tape & Reel
LM3535TME-2ALS		250 Units, Tape & Reel
LM3535TMX-2ALS		3000 Units, Tape & Reel

Absolute Maximum Ratings (Note 1, Note 2)

2)

If Military/Aerospace specified devices are required, please contact the National Semiconductor Sales Office/Distributors for availability and specifications.

V_{IN} pin voltage	-0.3V to 6.0V
SCL, SDIO, HWEN, PWM pin voltages	-0.3V to ($V_{IN}+0.3V$) w/ 6.0V max
I_{Dxx} Pin Voltages	-0.3V to ($V_{VOUT}+0.3V$) w/ 6.0V max
Continuous Power Dissipation <small>(Note 3)</small>	Internally Limited
Junction Temperature (T_{J-MAX})	150°C
Storage Temperature Range	-65°C to +150°C
Maximum Lead Temperature <small>(Soldering)</small>	<small>(Note 4)</small>
ESD Rating <small>(Note 5)</small>	
Human Body Model	2.0kV

Operating Rating

(Note 1, Note 2)

Input Voltage Range	2.7V to 5.5V
LED Voltage Range	2.0V to 4.0V
Junction Temperature (T_J) Range	-30°C to +110°C
Ambient Temperature (T_A) Range <small>(Note 6)</small>	-30°C to +85°C

Thermal Properties

Junction-to-Ambient Thermal Resistance (θ_{JA}), TMD20 Package <small>(Note 7)</small>	40°C/W
---	--------

Electrical Characteristics (Note 2, Note 8)

Limits in standard typeface are for $T_A = 25^\circ\text{C}$, and limits in boldface type apply over the full operating temperature range (-30°C to +85°C). Unless otherwise specified: $V_{IN} = 3.6V$; $V_{HWEN} = V_{IN}$; $V_{PWM} = 0V$; $V_{DxA} = V_{DxB} = V_{DxC} = 0.4V$; GroupA = GroupB = GroupC = Fullscale Current; ENxA, ENxB, ENxC Bits = "1"; 53A, 62A Bits = "0"; C1 = C2 = $C_{IN} = C_{OUT} = 1.0\mu\text{F}$. (Note 9)

Symbol	Parameter	Condition	Min	Typ	Max	Units
I_{Dxx}	Output Current Regulation GroupA	$2.7V \leq V_{IN} \leq 5.5V$ EN1A to EN4A = '1', 53A = 62A = '0', EN53 = EN62 = ENxB = ENxC = '0' 4 LEDs in GroupA	23.6 (-5.6%)	25	26.3 (+5.2%)	mA (%)
		$2.7V \leq V_{IN} \leq 5.5V$ EN1A to EN4A = EN53 = EN62 = '1', 53A = 62A = '1', ENxB = ENxC = '0' 6 LEDs in GroupA	23.2 (-7.2%)	25	26.3 (+5.2%)	mA (%)
	Output Current Regulation GroupB	$2.7V \leq V_{IN} \leq 5.5V$ EN1B = EN53 = EN62 = '1', 53A = 62A = '0', ENxA = ENxC = '0' 3 LEDs in GroupB	23.3 (-6.8%)	25	26.0 (+4.0%)	mA (%)
	Output Current Regulation IDC	$2.7V \leq V_{IN} \leq 5.5V$ ENC = '1', ENxA = ENxB = '0'	23.8 (-4.8%)	25	26.8 (+7.2%)	mA (%)
	Output Current Regulation GroupA, GroupB, and GroupC Enabled	$3.2V \leq V_{IN} \leq 5.5V$ $V_{LED} = 3.6V$		25 DxA 25 DxB 25 DxC		mA
$I_{Dxx-MATCH}$	LED Current Matching <small>(Note 10)</small>	$2.7V \leq V_{IN} \leq 5.5V$	GroupA (4 LEDs)	0.25	2.40	%
			GroupA (6 LEDs)	0.55	2.78	
			GroupB (3 LEDs)	0.25	2.41	
V_{DxTH}	V_{Dxx} 1x to 3/2x Gain Transition Threshold	V_{DxA} and/or V_{DxB} Falling		130		mV
V_{HR}	Current sink Headroom Voltage Requirement <small>(Note 11)</small>	$I_{Dxx} = 95\% \times I_{Dxx}(\text{nom.})$ ($I_{Dxx}(\text{nom.}) = 25\text{mA}$)		100		mV
R_{OUT}	Open-Loop Charge Pump Output Resistance	Gain = 3/2		2.4		Ω
		Gain = 1		0.5		

Symbol	Parameter	Condition	Min	Typ	Max	Units
I_Q	Quiescent Supply Current	Gain = 3/2, No Load		2.86	4.38	mA
		Gain = 1, No Load		1.09	2.31	
I_{SB}	Standby Supply Current	$2.7V \leq V_{IN} \leq 5.5V$ HWEN = V_{IN} , All ENx bits = "0"		1.7	4.0	μA
I_{SD}	Shutdown Supply Current	$2.7V \leq V_{IN} \leq 5.5V$ HWEN = 0V, All ENx bits = "0"		1.7	4.0	μA
f_{SW}	Switching Frequency		1.10	1.33	1.56	MHz
t_{START}	Start-up Time	$V_{OUT} = 90\%$ steady state		250		μs
V_{ALS}	ALS Reference Voltage Accuracy		0.95 (-5%)	1	1.05 (+5%)	V
R_{ALS}	ALS Resistor Accuracy	$R_{ALSA} = 9.08k\Omega$	-5		+5	%
		$R_{ALSA} = 5.46k\Omega$	-5		+5	
		$R_{ALSB} = 9.13k\Omega$	-5		+5	
		$R_{ALSB} = 5.52k\Omega$	-5		+5	
V_{HWEN}	HWEN Voltage Thresholds	$2.7V \leq V_{IN} \leq 5.5V$	Reset	0	0.45	V
			Normal Operation	1.2	V_{IN}	
V_{PWM}	PWM Voltage Thresholds	$2.7V \leq V_{IN} \leq 5.5V$	Diodes Off	0	0.45	V
			Diodes On	1.2	V_{IN}	
V_{OL-INT}	Interrupt Output Logic Low '0'	$I_{LOAD} = 3mA$			400	mV
I²C Compatible Interface Voltage Specifications (SCL, SDIO)						
V_{IL}	Input Logic Low '0'	$2.7V \leq V_{IN} \leq 5.5V$	0		0.45	V
V_{IH}	Input Logic High '1'	$2.7V \leq V_{IN} \leq 5.5V$	1.225		V_{IN}	V
V_{OL}	SDIO Output Logic Low '0'	$I_{LOAD} = 3mA$			400	mV
I²C Compatible Interface Timing Specifications (SCL, SDIO)(Note 12)						
t_1	SCL (Clock Period)	(Note 13)	2.5			μs
t_2	Data In Setup Time to SCL High		100			ns
t_3	Data Out stable After SCL Low		0			ns
t_4	SDIO Low Setup Time to SCL Low (Start)		100			ns
t_5	SDIO High Hold Time After SCL High (Stop)		100			ns

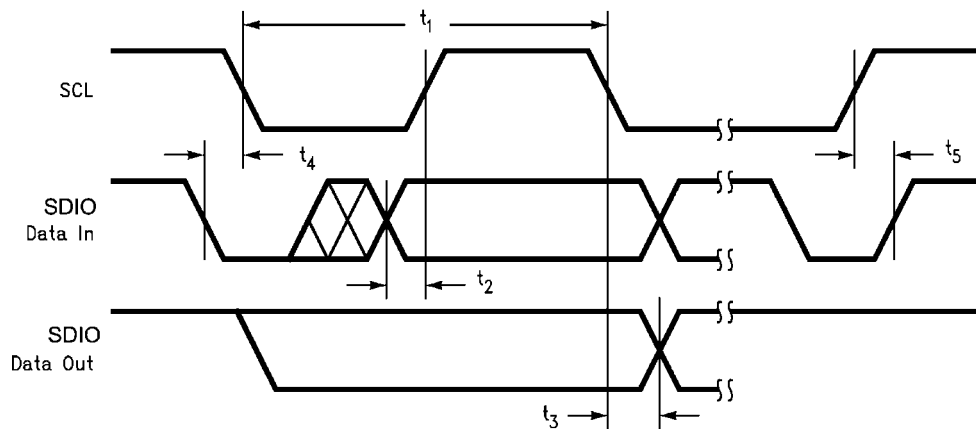

30082413

Note 1: Absolute Maximum Ratings indicate limits beyond which damage to the component may occur. Operating Ratings are conditions under which operation of the device is guaranteed. Operating Ratings do not imply guaranteed performance limits. For guaranteed performance limits and associated test conditions, see the Electrical Characteristics tables.

Note 2: All voltages are with respect to the potential at the GND pins.

Note 3: Internal thermal shutdown circuitry protects the device from permanent damage. Thermal shutdown engages at $T_J = 150^\circ\text{C}$ (typ.) and disengages at $T_J = 125^\circ\text{C}$ (typ.).

Note 4: For detailed soldering specifications and information, please refer to National Semiconductor Application Note 1112: Micro SMD Wafer Level Chip Scale Package (AN-1112).

Note 5: The human body model is a 100pF capacitor discharged through a 1.5k Ω resistor into each pin. (MIL-STD-883 3015.7)

Note 6: In applications where high power dissipation and/or poor package thermal resistance is present, the maximum ambient temperature may have to be derated. Maximum ambient temperature (T_{A-MAX}) is dependent on the maximum operating junction temperature ($T_{J-MAX-OP} = 110^\circ\text{C}$), the maximum power dissipation of the device in the application (P_{D-MAX}), and the junction-to ambient thermal resistance of the part/package in the application (θ_{JA}), as given by the following equation: $T_{A-MAX} = T_{J-MAX-OP} - (\theta_{JA} \times P_{D-MAX})$.

Note 7: Junction-to-ambient thermal resistance is highly dependent on application and board layout. In applications where high maximum power dissipation exists, special care must be paid to thermal dissipation issues in board design. For more information, please refer to National Semiconductor Application Note 1112: Micro SMD Wafer Level Chip Scale Package (AN-1112).

Note 8: Min and Max limits are guaranteed by design, test, or statistical analysis. Typical numbers are not guaranteed, but do represent the most likely norm.

Note 9: C_{IN} , C_{VOUT} , C_1 , and C_2 : Low-ESR Surface-Mount Ceramic Capacitors (MLCCs) used in setting electrical characteristics

Note 10: For the two groups of current sinks on a part (GroupA and GroupB), the following are determined: the maximum sink current in the group (MAX), the minimum sink current in the group (MIN), and the average sink current of the group (AVG). For each group, two matching numbers are calculated: (MAX-AVG)/AVG and (AVG-MIN)/AVG. The largest number of the two (worst case) is considered the matching figure for the Group. The matching figure for a given part is considered to be the highest matching figure of the two Groups. The typical specification provided is the most likely norm of the matching figure for all parts.

Note 11: For each Dxx pin, headroom voltage is the voltage across the internal current sink connected to that pin. For Group A, B, and C current sinks, $V_{HRx} = V_{OUT} - V_{LED}$. If headroom voltage requirement is not met, LED current regulation will be compromised.

Note 12: SCL and SDIO should be glitch-free in order for proper brightness control to be realized.

Note 13: SCL is tested with a 50% duty-cycle clock.

Block Diagram

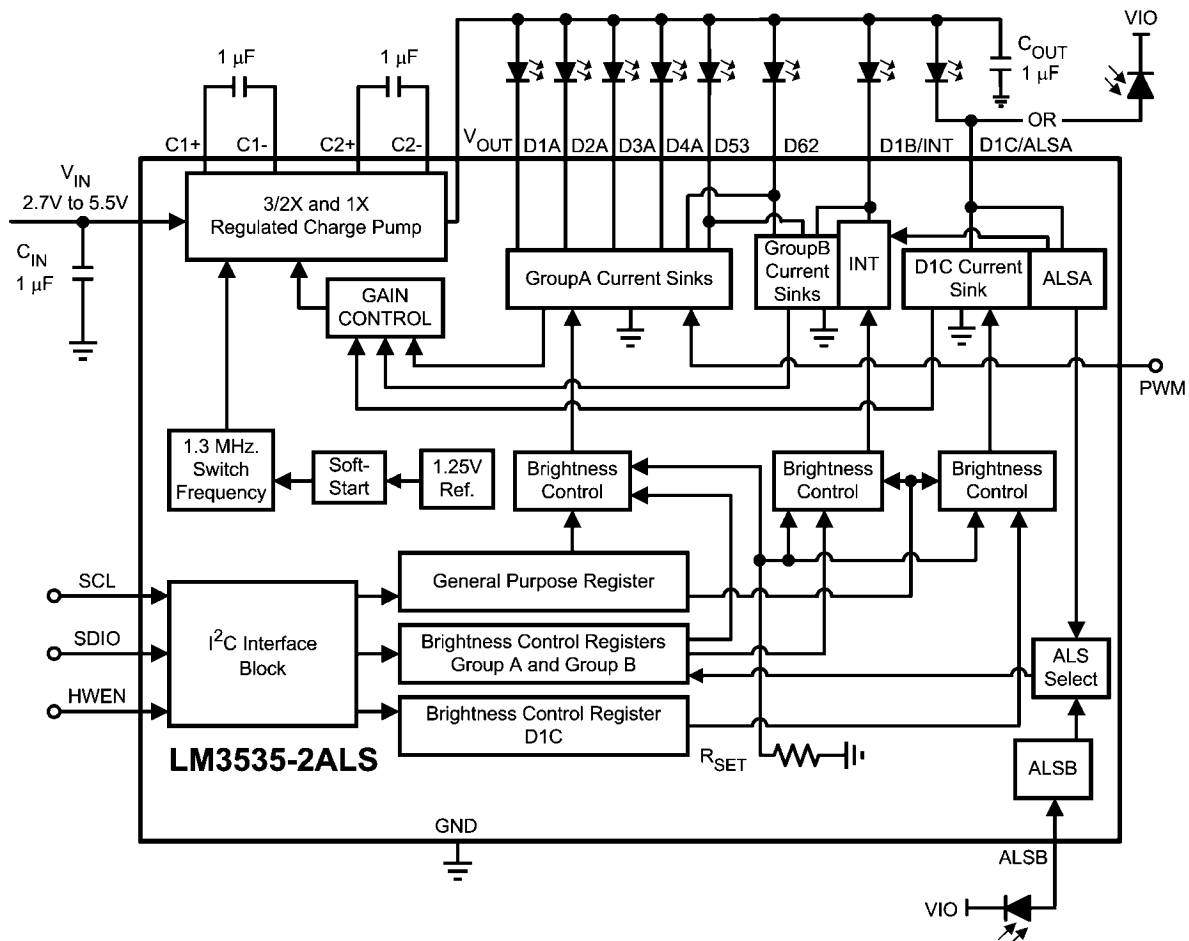

30082467

Typical Performance Characteristics

Unless otherwise specified: $T_A = 25^\circ\text{C}$; $V_{IN} = 3.6\text{V}$; $V_{HWEN} = V_{IN}$; $C_{IN} = 1\mu\text{F}$, $C_{OUT} = 1\mu\text{F}$, $C1=C2 = 1\mu\text{F}$.

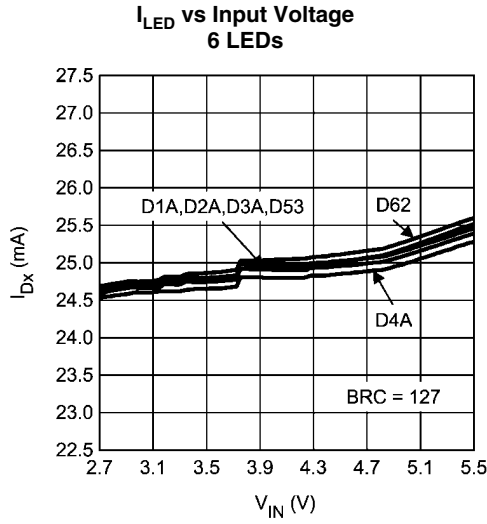

30082419

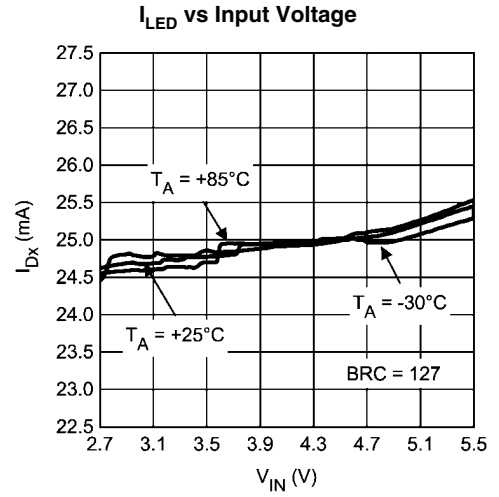

30082420

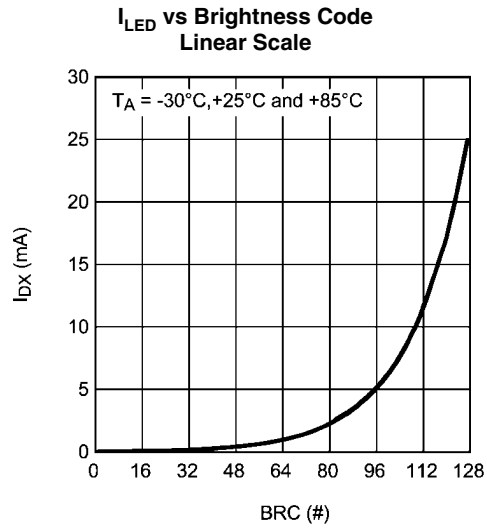

30082423

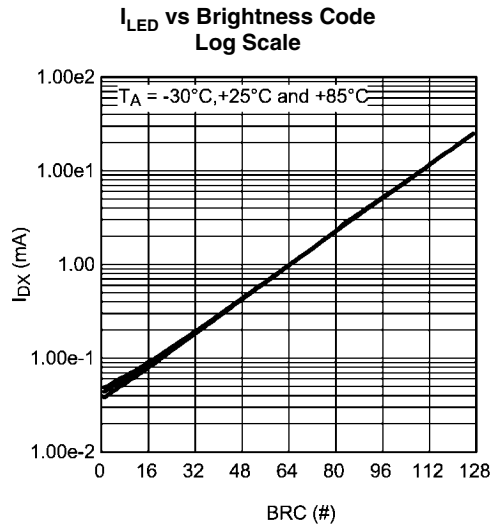

30082422

**Input Current vs Input Voltage
4 LEDs**

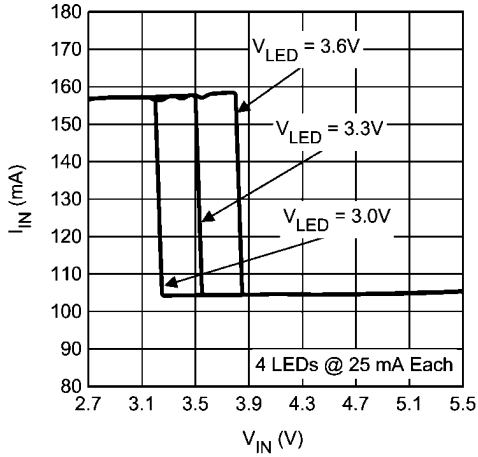

30082464

**LED Drive Efficiency vs Input Voltage
4 LEDs**

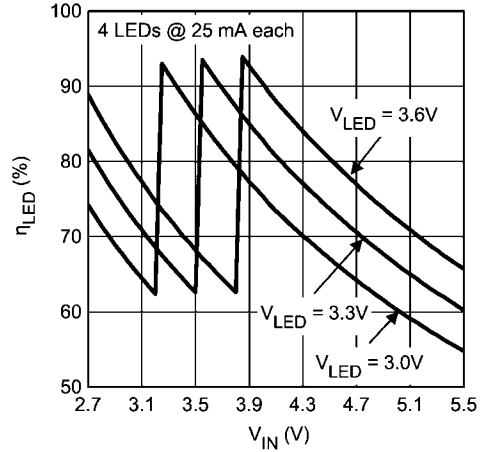

30082463

**Input Current vs Input Voltage
6 LEDs**

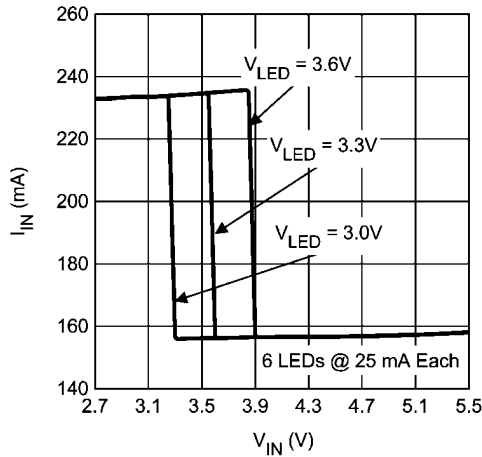

30082460

**LED Drive Efficiency vs Input Voltage
6 LEDs**

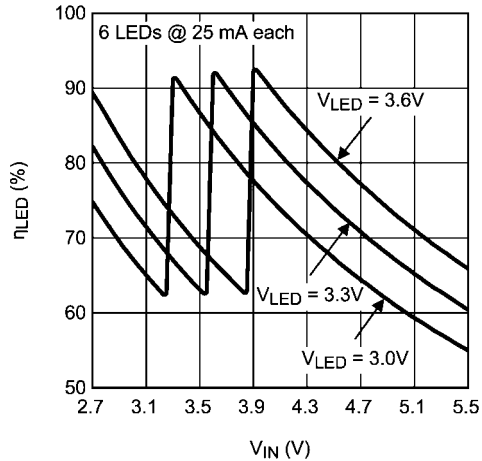

30082424

**Input Current vs Input Voltage
8 LEDs**

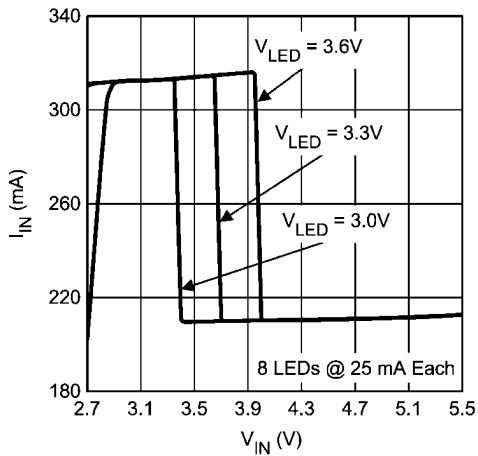

30082461

**LED Drive Efficiency vs Input Voltage
8 LEDs**

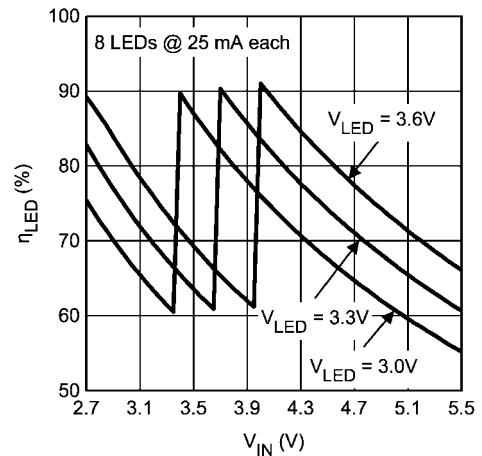

30082462

**LED Drive Efficiency vs Input Voltage
Tri-Temp 6 LEDs**

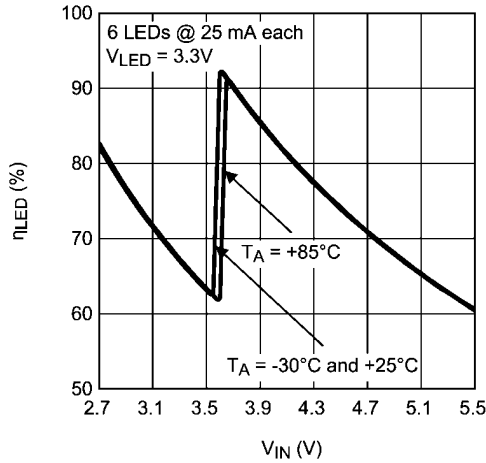

**I_{LED} Matching vs Input voltage
6 LEDs**

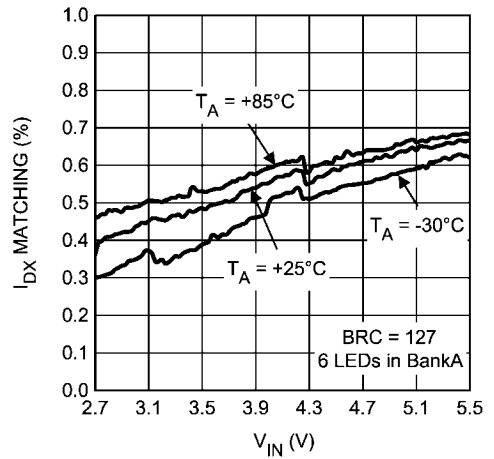

**Switching Frequency vs Input Voltage
Tri-Temp**

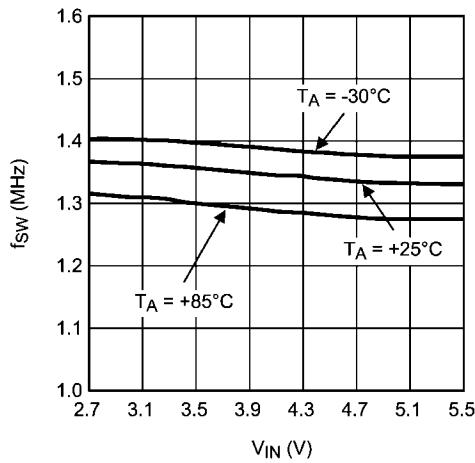

**Shutdown Current vs Input Voltage
VIO = 0V**

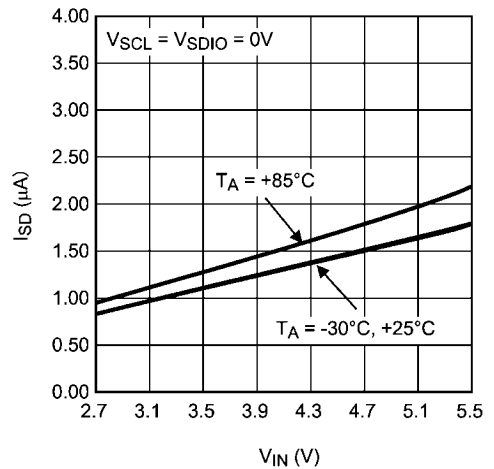

**Shutdown Current vs Input Voltage
VIO = 2.5V**

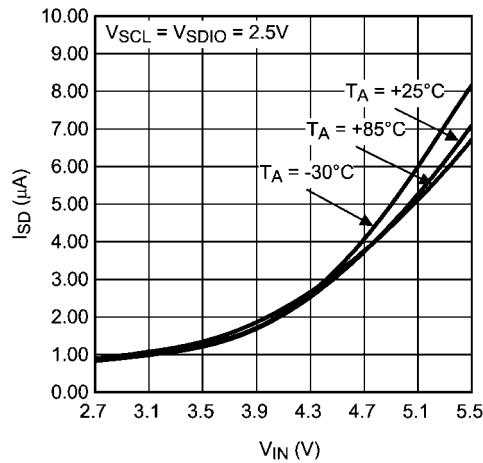

**Quiescent Current vs Input Voltage
1x Gain**

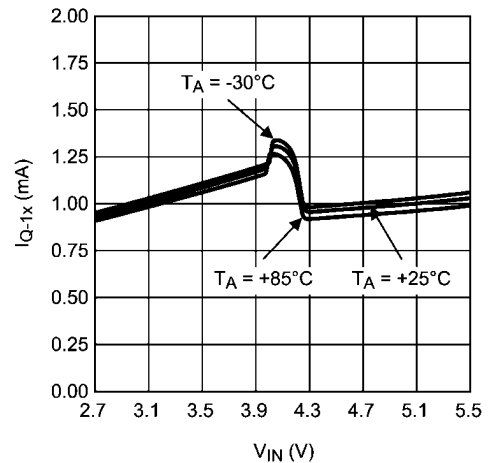

Quiescent Current vs Input Voltage
3/2x Gain

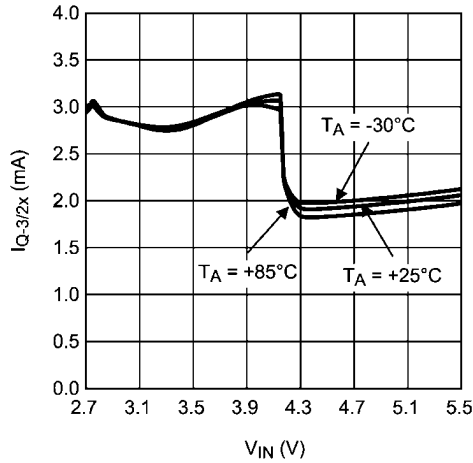

30082430

ALS Boundary Voltage vs. Boundary Code
Falling ALS Voltage

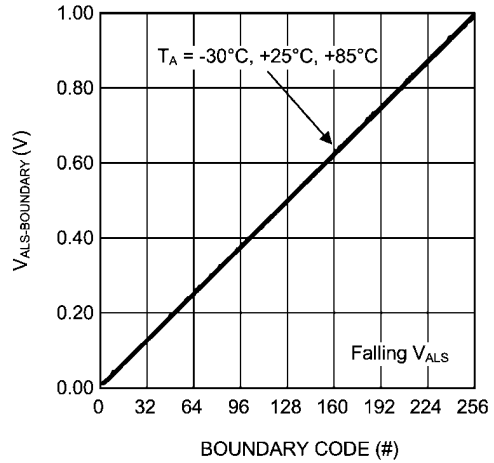

30082470

ALS Boundary Voltage vs. Boundary Code
Falling ALS Voltage (Zoom)

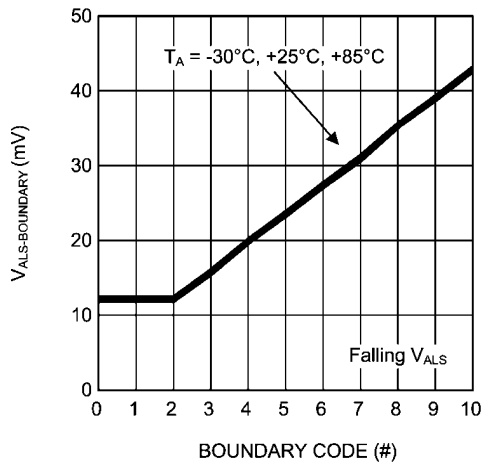

30082471

Diode Current vs PWM Duty Cycle

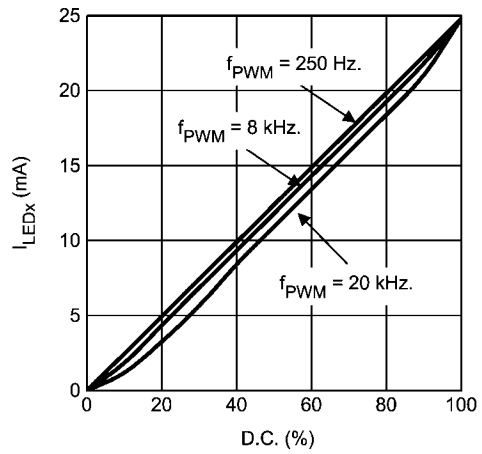

30082453

Ambient Light Sensor Response

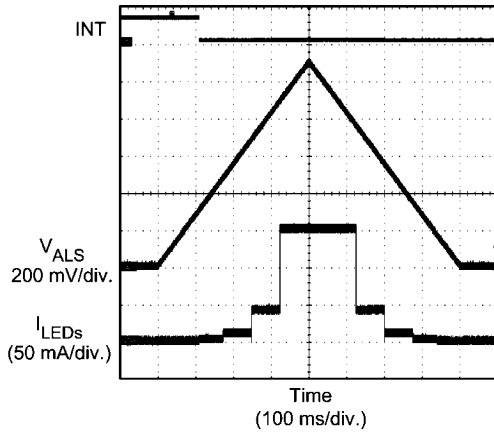

30082454

Diode Current Ramp-Up
 $t_{STEP} = 6ms$

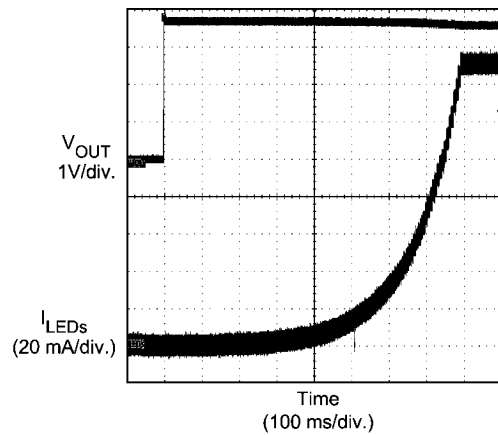

30082458

Diode Current Ramp-Down
 $t_{STEP} = 6ms$

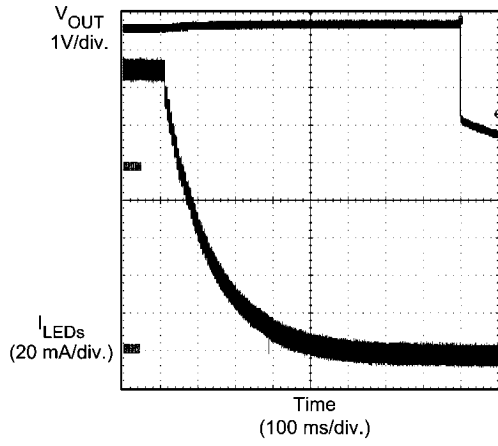

30082459

Circuit Description

OVERVIEW

The LM3535 is a white LED driver system based upon an adaptive $3/2\times - 1\times$ CMOS charge pump capable of supplying up to 200mA of total output current. With three separately controlled Groups of constant current sinks, the LM3535 is an ideal solution for platforms requiring a single white LED driver IC for main display, sub display, and indicator lighting. The tightly matched current sinks ensure uniform brightness from the LEDs across the entire small-format display.

Each LED is configured in a common anode configuration, with the peak drive current set to 25mA. An I²C compatible interface is used to enable the device and vary the brightness within the individual current sink Groups. For GroupA, 128 exponentially-spaced analog brightness control levels are available. GroupB and GroupC have 8 linearly-spaced analog brightness levels.

Additionally, the LM3535 provides 1 or 2 inputs (LM3535 has 1 and LM3535-2ALS has 2) for an Ambient Light Sensor to adaptively adjust the diode current based on ambient conditions, and a PWM pin to allow the diode current to be pulse width modulated to work with a display driver utilizing dynamic or content adjusted backlight control (DBC or CABC).

CIRCUIT COMPONENTS

Charge Pump

The input to the $3/2\times - 1\times$ charge pump is connected to the V_{IN} pin, and the regulated output of the charge pump is connected to the V_{OUT} pin. The recommended input voltage range of the LM3535 is 2.7V to 5.5V. The device's regulated charge pump has both open loop and closed loop modes of operation. When the device is in open loop, the voltage at V_{OUT} is equal to the gain times the voltage at the input. When the device is in closed loop, the voltage at V_{OUT} is regulated to 4.3V (typ.). The charge pump gain transitions are actively selected to maintain regulation based on LED forward voltage and load requirements.

Diode Current Sinks

Matched currents are ensured with the use of tightly matched internal devices and internal mismatch cancellation circuitry. There are eight regulated current sinks configurable into 3 different lighting regions.

Ambient Light Sensing (ALS) and Interrupt

The LM3535 provides an Ambient Light Sensing input (2 inputs on LM3535-2ALS version) for use with ambient backlight control. By connecting the anode of a photo diode / sensor to the sensor input pins, and configuring the appropriate ALS resistors, the LM3535 or -2ALS version, can be configured to adjust the diode current to five unique settings, corresponding to four adjustable light region trip points. Additionally, when the LM3535 determines that an ambient condition has changed, the interrupt pin, when connected to a pull-up resistor will toggle to a '0' alerting the controller. See the I²C interface section for more details regarding the register configurations.

Dynamic Backlight Control Input (PWM Pin)

A PWM (Pulse Width Modulation) pin is provided on the LM3535 to allow a display driver utilizing dynamic backlight control (DBC), to adjust the LED brightness based on the content. The PWM input can be turned on or off (Acknowledge or Ignore) and the polarity can be flipped (active high or active low) through the I²C interface. The current sinks of the

LM3535 require approximately 15 μ s. to reach steady-state target current. This turn-on time sets the minimum usable PWM pulse width for DBC/CABC.

LED Forward Voltage Monitoring

The LM3535 has the ability to switch gains ($1\times$ or $3/2\times$) based on the forward voltage of the LED load. This ability to switch gains maximizes efficiency for a given load. Forward voltage monitoring occurs on all diode pins. At higher input voltages, the LM3535 will operate in pass mode, allowing the V_{OUT} voltage to track the input voltage. As the input voltage drops, the voltage on the Dxx pins will also drop ($V_{DXX} = V_{VOUT} - V_{LEDX}$). Once any of the active Dxx pins reaches a voltage approximately equal to 130mV, the charge pump will switch to the gain of $3/2$. This switch-over ensures that the current through the LEDs never becomes pinched off due to a lack of headroom across the current sinks. **Once a gain transition occurs, the LM3535 will remain in the gain of $3/2$ until an I²C write to the part occurs. At that time, the LM3535 will re-evaluate the LED conditions and select the appropriate gain.**

Only active Dxx pins will be monitored.

Configurable Gain Transition Delay

To optimize efficiency, the LM3535 has a user selectable gain transition delay that allows the part to ignore short duration input voltage drops. By default, the LM3535 will not change gains if the input voltage dip is shorter than 3 to 6 milliseconds. There are four selectable gain transition delay ranges (4 for LM3535-2ALS and 3 for LM3535) available on the LM3535. All delay ranges are set within the VF Monitor Delay Register. Please refer to the *INTERNAL REGISTERS* section of this datasheet for more information regarding the delay ranges.

Hardware Enable (HWEN)

The LM3535 has a hardware enable/reset pin (HWEN) that allows the device to be disabled by an external controller without requiring an I²C write command. Under normal operation, the HWEN pin should be held high (logic '1') to prevent an unwanted reset. When the HWEN is driven low (logic '0'), all internal control registers reset to the default states and the part becomes disabled. Please see the *Electrical Characteristics* section of the datasheet for required voltage thresholds.

I²C Compatible Interface

DATA VALIDITY

The data on SDIO line must be stable during the HIGH period of the clock signal (SCL). In other words, state of the data line can only be changed when SCL is LOW.

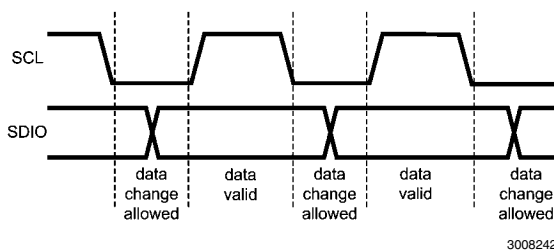

FIGURE 1. Data Validity Diagram

A pull-up resistor between the controller's VIO line and SDIO must be greater than $[(VIO - V_{OL}) / 3mA]$ to meet the V_{OL} requirement on SDIO. Using a larger pull-up resistor results in lower switching current with slower edges, while using a

smaller pull-up results in higher switching currents with faster edges.

START AND STOP CONDITIONS

START and STOP conditions classify the beginning and the end of the I²C session. A START condition is defined as SDIO signal transitioning from HIGH to LOW while SCL line is HIGH. A STOP condition is defined as the SDIO transitioning from LOW to HIGH while SCL is HIGH. The I²C master always generates START and STOP conditions. The I²C bus is considered to be busy after a START condition and free after a STOP condition. During data transmission, the I²C master can generate repeated START conditions. First START and repeated START conditions are equivalent, function-wise.

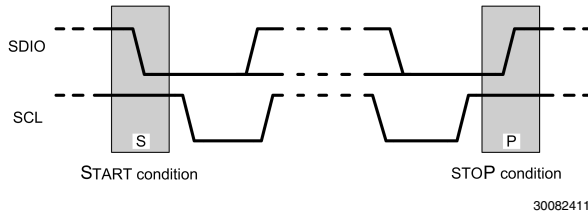

FIGURE 2. Start and Stop Conditions

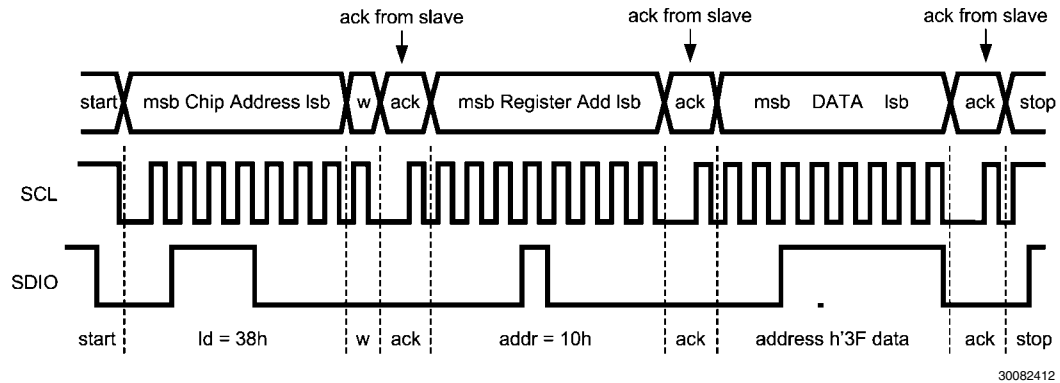

FIGURE 3. Write Cycle

w = write (SDIO = "0")

r = read (SDIO = "1")

ack = acknowledge (SDIO pulled down by either master or slave)

id = chip address, 38h for LM3535

TRANSFERRING DATA

Every byte put on the SDIO line must be eight bits long, with the most significant bit (MSB) transferred first. Each byte of data has to be followed by an acknowledge bit. The acknowledge related clock pulse is generated by the master. The master releases the SDIO line (HIGH) during the acknowledge clock pulse. The LM3535 pulls down the SDIO line during the 9th clock pulse, signifying an acknowledge. The LM3535 generates an acknowledge after each byte is received. There is no acknowledge created after data is read from the LM3535.

After the START condition, the I²C master sends a chip address. This address is seven bits long followed by an eighth bit which is a data direction bit (R/W). The LM3535 7-bit address is 38h. For the eighth bit, a "0" indicates a WRITE and a "1" indicates a READ. The second byte selects the register to which the data will be written. The third byte contains data to write to the selected register.

I²C COMPATIBLE CHIP ADDRESS

The 7-bit chip address for LM3535 is 111000, or 0x38.

INTERNAL REGISTERS OF LM3535

Register	Internal Hex Address	Power On Value	
Diode Enable Register	0x10	0000 0000 (0x00)	
Configuration Register	0x20	0000 0000 (0x00)	
Options Register	0x30	0000 0000 (0x00)	
ALS Zone Readback	0x40	1111 0000 (0xF0)	
ALS Control Register	0x50	1 ALS Version	0000 0011 (0x03)
		2 ALS Version	0000 0000 (0x00)
ALS Resistor Register	0x51	0000 0000 (0x00)	
ALS Select Register	0x52 LM3535-2ALS Only	1111 0001 (0xF1)	
ALS Zone Boundary #0	0x60	0011 0011 (0x33)	
ALS Zone Boundary #1	0x61	0110 0110 (0x66)	
ALS Zone Boundary #2	0x62	1001 1001 (0x99)	
ALS Zone Boundary #3	0x63	1100 1100 (0xCC)	
ALS Brightness Zone #1	0x70	1001 1001 (0x99)	
ALS Brightness Zone #2	0x71	1011 0110 (0xB6)	
ALS Brightness Zone #3	0x72	1100 1100 (0xCC)	
ALS Brightness Zone #4	0x73	1110 0110 (0xE6)	
ALS Brightness Zone #5	0x74	1111 1111 (0xFF)	
Group A Brightness Control Register	0xA0	1000 0000 (0x80)	
Group B Brightness Control Register	0xB0	1100 0000 (0xC0)	
Group C Brightness Control Register	0xC0	1111 1000 (0xF8)	

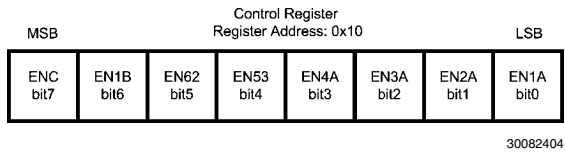

FIGURE 4. Diode Enable Register Description
Internal Hex Address: 0x10

Each ENx Bit controls the state of the corresponding current sink. Writing a '1' to these bits enables the current sinks. Writing a '0' disables the current sinks. In order for current to begin flowing through the BankA current sinks, the brightness codes stored in either the BankA Brightness register or the ALS Brightness registers (with ALS enabled) must be non-zero. The BankA current sinks can be disabled in two different manners. Writing '0' to the ENx bits when the current sinks are active will disable the current sinks without going through the ramp down sequence. Additionally, setting the BankA brightness code to '0' when the current sinks are active (ENx = '1') does force the diode current to ramp down. All ramping behavior is tied to the BankA Brightness or ALS Brightness Register settings. Any change in these values will cause the LM3535 brightness state machine to ramp the diode current.

Writing a '1' to ENC, EN1B, EN62 and EN53 (when EN62 and EN53 are assigned to BankB) by default will enable the corresponding current sinks and drive the LEDs to the current value stored in the BankB and BankC brightness registers. Writing a '0' to these bits immediately disables the current sinks.

The ENC and EN1B bits are ignored if the D1C/ALS pin is configured as an ALS input and if the D1B/INT is configured as an interrupt flag.

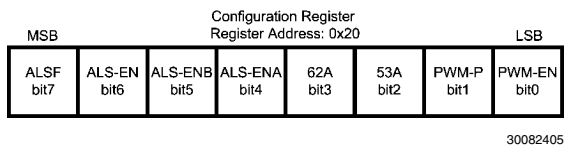

FIGURE 5. Configuration Register Description
Internal Hex Address: 0x20

- PWM-EN: PWM Input Enable. Writing a '1' = Enable, and a '0' = Ignore (default).
- PWM-P: PWM Input Polarity. Writing a '0' = Active High (default) and a '1' = Active Low.
- 53A: Assign D53 diode to BankA. Writing a '0' assigns D53 to BankB (default) and a '1' assigns D53 to BankA.
- 62A: Assign D62 diode to BankA. Writing a '0' assigns D62 to BankB (default) and a '1' assigns D62 to BankA.
- ALS-ENA: Enable ALS on BankA. Writing a '1' enables ALS control of diode current and a '0' (default) forces the BankA current to the value stored in the BankA brightness register. The ALS-EN bit must be set to a '1' for the ALS block to control the BankA brightness.
- ALS-ENB: Enable ALS on BankB. Writing a '1' enables ALS control of diode current and a '0' (default) forces the BankB current to the value stored in the BankB brightness register. The ALS-EN bit must be set to a '1' for the ALS block to control the BankB brightness. The ALS function for BankB is different than BankA in that the ALS will only enable and disable the BankB diodes depending on the ALS zone chosen by the user. BankA utilizes the 5

different zone brightness registers (Addresses 0x70 to 0x74).

- **ALS-EN:** Enables ALS monitoring. Writing a '1' enables the ALS monitoring circuitry and a '0' disables it. This feature can be enabled without having the current sinks or charge pump active. The ALS value is updated in register 0x40 (ALS Zone Register)
- **ALSF:** ALS Interrupt Enable. Writing a '1' sets the D1B/INT pin to the ALS interrupt pin and writing a '0' (default) sets the pin to a BankB current sink.

Options Register
Register Address: 0x30

GT1 bit7	GT0 bit6	RD2 bit5	RD1 bit4	RD0 bit3	RU2 bit2	RU1 bit1	RU0 bit0
-------------	-------------	-------------	-------------	-------------	-------------	-------------	-------------

30082406

FIGURE 6. Options Register
Internal Hex Address: 0x30

- **RD0-RD2:** Diode Current Ramp Down Step Time. : '000' = 6μs, '001' = 0.77ms, '010' = 1.5ms, '011' = 3ms, '100' = 6ms, '101' = 12ms, '110' = 25ms, '111' = 50ms
- **RU0-RU2:** Diode Current Ramp Up Step Time. : '000' = 6μs, '001' = 0.77ms, '010' = 1.5ms, '011' = 3ms, '100' = 6ms, '101' = 12ms, '110' = 25ms, '111' = 50ms
- **GT0-GT1:** Gain Transition Filter. The value stored in this register determines the filter time used to make a gain transition in the event of an input line step. Filter Times = '00' = 3-6ms, '01' = 0.8-1.5ms, '10' = 20μs, **On LM3535-2ALS, '11' = 1μs, On LM3535, '11' = DO NOT USE**

The Ramp-Up and Ramp-Down times follow the following equations: $T_{RAMP} = (N_{Start} - N_{Target}) \times \text{Ramp-Step Time}$

DxA Brightness Control
Register Address: 0xA0

1 bit7	DxA6 bit6	DxA5 bit5	DxA4 bit4	DxA3 bit3	DxA2 bit2	DxA1 bit1	DxA0 bit0
-----------	--------------	--------------	--------------	--------------	--------------	--------------	--------------

30082409

DxB Brightness Control Register Address: 0xB0							
1 bit7	1 bit6	ALSZT2 bit5	ALSZT1 bit4	ALSZT0 bit3	DxB2 bit2	DxB1 bit1	DxB0 bit0

30082410

DxC Brightness Control Register Address: 0xC0							
1 bit7	1 bit6	1 bit5	1 bit4	1 bit3	D1C2 bit2	D1C1 bit1	D1C0 bit0

30082414

FIGURE 7. Brightness Control Register Description
Internal Hex Address: 0xA0 (GroupA), 0xB0 (GroupB),
0xC0 (GroupC)

Note: DxA6-DxA0: Sets Brightness for DxA pins (GroupA). 1111111=Fullscale. Code '0' in this register disables the BankA current sinks.

DxB2-DxB0: Sets Brightness for DxB pins (GroupB). 111=Fullscale
ALSZT2-ALSZT0: Sets the Brightness Zone boundary used to enable and disable BankB diodes based upon ambient lighting conditions.

DxC2-DxC0: Sets Brightness for D1C pin. 111 = Fullscale

The BankA Current can be approximated by the following equation where N = BRC = the decimal value stored in either the BankA Brightness Register or the five different ALS Zone Brightness Registers:

$$I_{LED} \text{ (mA)} \approx 25 \times 0.85^{[44 - \{(N+1)/2.91\}]}$$

Or

$$BRC \text{ (#)} \approx 127 + 17.9 \times \text{LN}(I_{LED(\text{mA})}/25 \text{ mA})$$

30082418

TABLE 1. I_{LED} vs. Brightness Register Data

BankA or ALS Brightness Data	% of I_{LED_MAX}	BankA or ALS Brightness Data	% of I_{LED_MAX}	BankA or ALS Brightness Data	% of I_{LED_MAX}	BankA or ALS Brightness Data	% of I_{LED_MAX}
0000000	0.000%	0100000	0.803%	1000000	4.078%	1100000	20.713%
0000001	0.166%	0100001	0.845%	1000001	4.290%	1100001	21.792%
0000010	0.175%	0100010	0.889%	1000010	4.514%	1100010	22.928%
0000011	0.184%	0100011	0.935%	1000011	4.749%	1100011	24.122%
0000100	0.194%	0100100	0.984%	1000100	4.996%	1100100	25.379%
0000101	0.204%	0100101	1.035%	1000101	5.257%	1100101	26.701%
0000110	0.214%	0100110	1.089%	1000110	5.531%	1100110	28.092%
0000111	0.226%	0100111	1.146%	1000111	5.819%	1100111	29.556%
0001000	0.237%	0101000	1.205%	1001000	6.122%	1101000	31.096%
0001001	0.250%	0101001	1.268%	1001001	6.441%	1101001	32.716%
0001010	0.263%	0101010	1.334%	1001010	6.776%	1101010	34.420%
0001011	0.276%	0101011	1.404%	1001011	7.129%	1101011	36.213%
0001100	0.291%	0101100	1.477%	1001100	7.501%	1101100	38.100%
0001101	0.306%	0101101	1.554%	1001101	7.892%	1101101	40.085%
0001110	0.322%	0101110	1.635%	1001110	8.303%	1101110	42.173%
0001111	0.339%	0101111	1.720%	1001111	8.735%	1101111	44.371%
0010000	0.356%	0110000	1.809%	1010000	9.191%	1110000	46.682%
0010001	0.375%	0110001	1.904%	1010001	9.669%	1110001	49.114%
0010010	0.394%	0110010	2.003%	1010010	10.173%	1110010	51.673%
0010011	0.415%	0110011	2.107%	1010011	10.703%	1110011	54.365%
0010100	0.436%	0110100	2.217%	1010100	11.261%	1110100	57.198%
0010101	0.459%	0110101	2.332%	1010101	11.847%	1110101	60.178%
0010110	0.483%	0110110	2.454%	1010110	12.465%	1110110	63.313%
0010111	0.508%	0110111	2.582%	1010111	13.114%	1110111	66.611%
0011000	0.535%	0110111	2.716%	1011000	13.797%	1111000	70.082%
0011001	0.563%	0111000	2.858%	1011001	14.516%	1111001	73.733%
0011010	0.592%	0111001	3.007%	1011010	15.272%	1111010	77.574%
0011011	0.623%	0111010	3.163%	1011011	16.068%	1111011	81.616%
0011100	0.655%	0111011	3.328%	1011100	16.905%	1111100	85.868%
0011101	0.689%	0111100	3.502%	1011101	17.786%	1111101	90.341%
0011110	0.725%	0111101	3.684%	1011110	18.713%	1111110	95.048%
0011111	0.763%	0111111	3.876%	1011111	19.687%	1111111	100.000%

GroupB and GroupC Brightness Levels = 2.5, 5, 7.5, 10, 12.5, 15, 17.5, 25mA

Internal Hex Address: 0x40

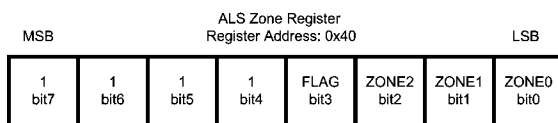

30082407

FIGURE 8. ALS Zone Register Description

- ZONE0-ZONE2: ALS Zone information: '000' = Zone0, '001' = Zone1, '010' = Zone2, '011' = Zone3, '100' = Zone4. Other combinations not used
- FLAG: ALS Transition Flag. '1' = Transition has occurred. '0' = No Transition. The FLAG bit is cleared once the 0x40 register has been read.

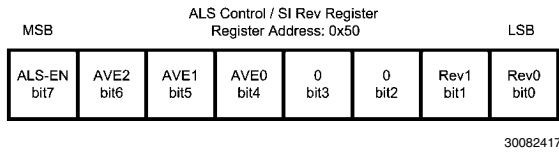

30082417

FIGURE 9. ALS Control / Silicon Revision Register Description
Internal Hex Address: 0x50

- Rev0-Rev1 : Stores the Silicon Revision value. LM3535 = '11', LM3535-2ALS = '00'
- AVE2-AVE0: Sets Averaging Time for ALS sampling. Need two to three Averaging periods to make transition decision. '000' = 25ms, '001' = 50ms, '010' = 100ms, '011' = 200ms, '100' = 400ms, '101' = 800ms, '110' = 1.6s, '111' = 3.2s

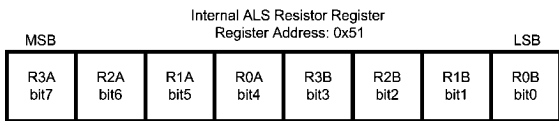

30082466

ALS Resistor Control Register Description
Internal Hex Address: 0x51

FIGURE 10.

- R3A-R0A are valid on both the LM3535 and LM3535-2ALS.
- R3B-R0B are only valid on LM3535-2ALS.
- R0-R3: Sets the internal ALS resistor value

Internal ALS Resistor Table

R3x	R2x	R1x	R0x	ALSA Resistor Value (Ω)	ALSB Resistor Value (Ω)
0	0	0	0	High Impedance	
0	0	0	1	13.6k	13.65k
0	0	1	0	9.08k	9.13k
0	0	1	1	5.47k	5.52k
0	1	0	0	2.32k	2.37k
0	1	0	1	1.99k	2.05k
0	1	1	0	1.86k	1.92k
0	1	1	1	1.65k	1.70k
1	0	0	0	1.18k	1.24k
1	0	0	1	1.10k	1.15k
1	0	1	0	1.06k	1.11k
1	0	1	1	986	1.04
1	1	0	0	804	858
1	1	0	1	764	818
1	1	1	0	745	799
1	1	1	1	711	765

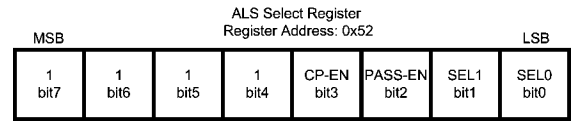

30082465

ALS Select Register (2-ALS Version Only)
Internal Hex Address: 0x52

FIGURE 11.

- CP-EN: Forces the LM3535 to operate in the gain of 1.5x exclusively when the Dx current sinks are enabled.
- PASS-EN: Forces the LM3535 to operate in the 1x Pass-Mode exclusively when the Dx current sinks are enabled.

CP-EN	PASS-EN	RESULT
0	0	Normal Operation
0	1	Pass-Mode Only
1	0	1.5x Gain Only
1	1	1.5x Gain Only

- SEL1-SEL0: ALS Selection Bits. SEL1 and SEL0 determine how the ALS sensor information is processed. '00' = Min. of ALSA and ALSB used, '01' = ALSA used and ALSB ignored (DEFAULT), '10' = ALSB Used and ALSA ignored, '11' = Max. of ALSA and ALSB used.

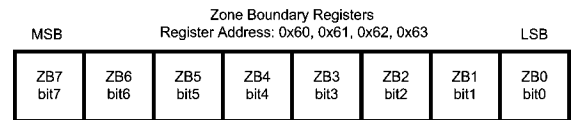

Register Address:
0x60 = Zone Boundary 0
0x61 = Zone Boundary 1
0x62 = zone Boundary 2
0x63 = Zone Boundary 3

30082415

FIGURE 12. Zone Boundary Register Descriptions

- ZB7-ZB0: Sets Zone Boundary Lines with a Falling ALS voltage.
0xFF w/ ALS Falling = 992.3mV (typ.).
 $V_{TRIP-LOW} (typ) = [Boundary Code \times 3.874mV] + 4.45mV$
For boundary codes 2 to 255. Code 0 and Code1 are mapped to equal the Code2 value.
Each zone line has approx. 5.5mV of hysteresis between the falling and rising ALS trip points..
- Zone Boundary 0 is the line between ALS Zone 0 and Zone 1. Default Code = 0x33 or approx. 200mV
- Zone Boundary 1 is the line between ALS Zone 1 and Zone 2. Default Code = 0x66 or approx. 400mV
- Zone Boundary 2 is the line between ALS Zone 2 and Zone 3. Default Code = 0x99 or approx. 600mV
- Zone Boundary 3 is the line between ALS Zone 3 and Zone 4. Default Code = 0xCC or approx. 800mV

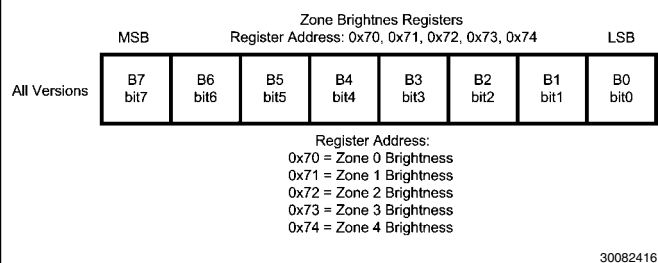

FIGURE 13. Zone Brightness Region Register Description

- B7-B0: Sets the ALS Zone Brightness Code. B7 always = '1' (unused). Use the formula found in the BankA

Brightness Register Description (*Figure 7*) to set the desired target brightness. Default values can be overwritten

- Zone0 Brightness Address = 0x70. Default = 0x99 (25) or 0.084mA
- Zone1 Brightness Address = 0x71. Default = 0xB6 (54) or 0.164mA
- Zone2 Brightness Address = 0x72. Default = 0xCC (76) or 1.45mA
- Zone3 Brightness Address = 0x73. Default = 0xE6 (102) or 6.17mA
- Zone4 Brightness Address = 0x74. Default = 0xFF (127) or 25mA

Application Information

AMBIENT LIGHT SENSING

Ambient Light Sensor Block

The LM3535 incorporates an Ambient Light Sensing interface (ALS) which translates an analog output ambient light sensor to a user specified brightness level. The ambient light sensing circuit has 4 programmable boundaries (ZB0 – ZB3) which define 5 ambient brightness zones. Each ambient brightness zone corresponds to a programmable brightness threshold (ZOT – Z4T).

Furthermore, the ambient light sensing inputs (ALSA and ALSB(LM3535-2ALS)) features 15 internal software selectable voltage setting resistors. This allows the LM3535 the capability of interfacing with a wide selection of ambient light sensors. Additionally, the ALS inputs can be configured as high impedance, thus providing for a true shutdown during low power modes. The ALS resistors are selectable through the ALS Resistor Select Register (see [Internal ALS Resistor Table](#)). [Figure 14](#) shows a functional block diagram of the ambient light sensor input.

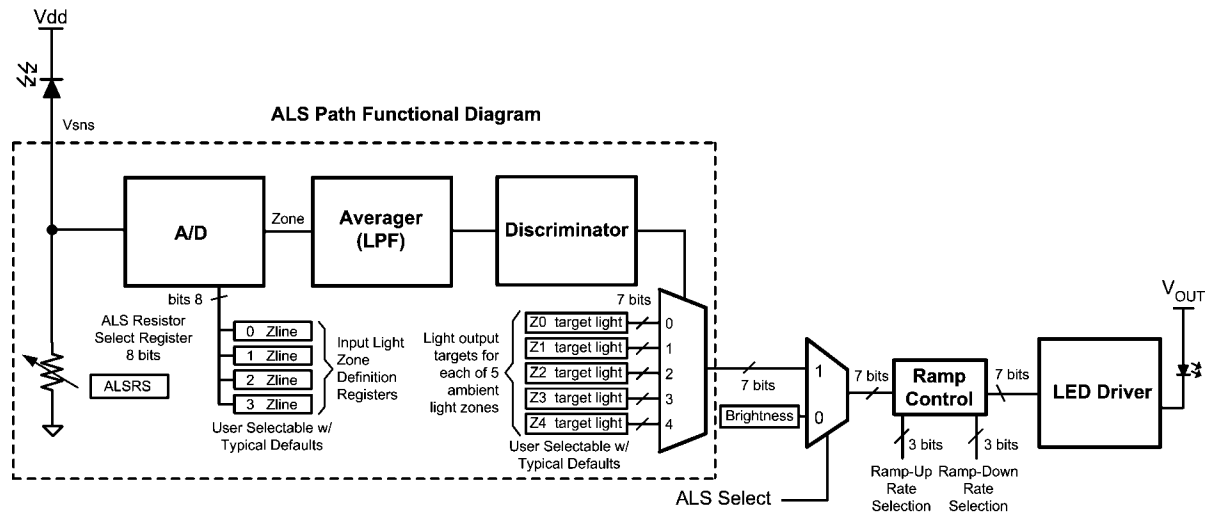

30082442

FIGURE 14. Ambient Light Sensor Functional Block Diagram

ALS Operation

The ambient light sensor input has a 0 to 1V operational input voltage range. The Typical Application Circuit shows the LM3535 with an ambient light sensor (AVAGO, APDS-9005) and the internal ALS Resistor Select Register set to 0x40 (2.32k Ω). This circuit converts 0 to 1000 LUX light into approximately a 0 to 850mV linear output voltage. The voltage at the active ambient light sensor input is compared against the 8 bit values programmed into the Zone Boundary Registers (ZB0-ZB3). When the ambient light sensor output crosses one of the ZB0 – ZB3 programmed thresholds the internal ALS circuitry will smoothly transition the LED current to the new 7 bit brightness level as programmed into the appropriate Zone Target Register (ZOT – Z4T, See [Figure 13](#)).

With bits [6:4] of the Configuration Register set to 1 (Bit6 = ALS Block Enable, Bit5 = BankB ALS Enable, Bit4 = BankA ALS Enable), the LM3535 is configured for Ambient Light Current Control. In this mode the ambient light sensing input (ALS) monitors the output of analog output ambient light sensing photo diode and adjusts the LED current depending on the ambient light. The ambient light sensing circuit has 4 configurable Ambient Light Boundaries (ZB0 – ZB3) pro-

grammed through the four (8-bit) Zone Boundary Registers. These zone boundaries define 5 ambient brightness zones.

On start-up the 4 Zone Boundary Registers are pre-loaded with 0x33 (51d), 0x66 (102d), 0x99 (153d), and 0xCC (204d). The ALS input has a 1V active input voltage range which makes the default Zone Boundaries approx. set at:

- Zone Boundary 0 = 200mV
- Zone Boundary 1 = 400mV
- Zone Boundary 2 = 600mV
- Zone Boundary 3 = 800mV

These Zone Boundary Registers are all 8-bit (readable and writable) registers. By Default, the first zone (Z0) is defined between 0 and 200mV, Z1's default is defined between 200mV and 400mV, Z2 is defined between 400mV and 600mV, Z3 is defined between 600mV and 800mV, and Z4 is defined between 800mV and 1V. The default settings for the 5 Zone Target Registers are 0x19, 0x33, 0x4C, 0x66, and 0x7F. This corresponds to LED brightness settings of 84 μ A, 164 μ A, 1.45mA, 6.17mA and 25mA of current respectively. See [Figure 15](#).

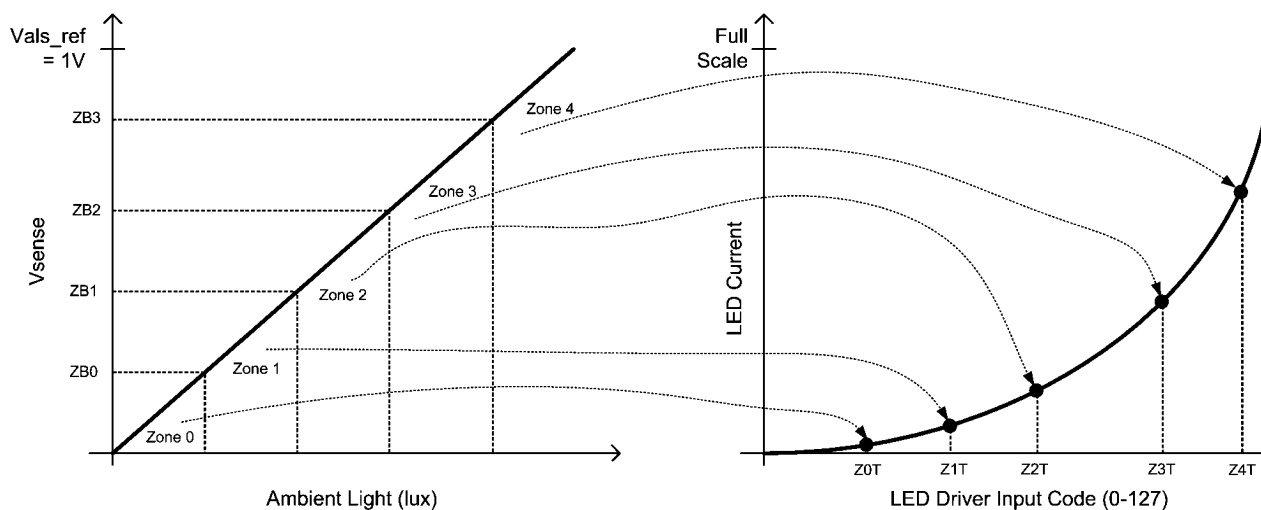

ALS Zone to LED Brightness Mapping

FIGURE 15.

ALS Configuration Example

As an example, assume that the APDS-9005 is used as the ambient light sensing photo diode with its output connected to the ALSA input. The ALS Resistor Select Register (Address 0x51) is loaded with 0x40 which configures the ALS input for a 2.32k Ω internal pull-down resistor (see [Internal ALS Resistor Table](#)). This gives the output of the APDS-9005 a typical voltage swing of 0 to 875mV with a 0 to 1k LUX change in ambient light (0.875mV/Lux). Next, the Configuration Register (Address 0x20) is programmed with 0xDC, the ALS Control Register (Address 0x50) programmed to 0x40 and the Control Register is programmed to 0x3F. This configures the LM3535's ambient light sensing interface for:

- Ambient Light Current Control for BankA Enabled
- ALS circuitry Enabled
- Assigns D53 and D62 to bankA
- Sets the ALS Averaging Time to 400ms

Next, the Control Register (Address 0x10) is programmed with 0x3F which enables the 6 LEDs via the I²C compatible interface.

Now assume that the APDS-9005 ambient light sensor detects a 100 LUX ambient light at its input. This forces the ambient light sensors output (and the ALS1 input) to 87.5mV corresponding to Zone 0. Since Zone 0 points to the brightness code programmed in Zone Target Register 0 (loaded with code 0x19), the LED current becomes:

$$I_{LED} = I_{LED_FS} \times \text{ZoneTarget0} = 25 \text{ mA} \times 0.336\% \approx 84 \mu\text{A}.$$

Next assume that the ambient light changes to 500 LUX (corresponding to an ALS1 voltage of 437.5mV). This moves the ambient light into Zone 2 which corresponds to Zone Target Register 2 (loaded with code 0x4C) the LED current then becomes:

$$I_{LED} = I_{LED_FS} \times \text{ZoneTarget2} = 25 \text{ mA} \times 5.781\% \approx 1.45 \text{ mA}$$

This Example still applies to the LM3535-2ALS version using two ambient light sensors. The ALS selector block makes the front end decision as to which sensor to use.

ALS Averaging Time

The ALS Averaging Time is the time over which the Averager block collects samples from the A/D converter and then averages them to pass to the discriminator block (see). Ambient light sensor samples are averaged and then further processed by the discriminator block to provide rejection of noise and transient signals. The Averager is configurable with 8 different averaging times to provide varying amounts of noise and transient rejection (see [Figure 9](#)). The discriminator block algorithm has a maximum latency of two averaging cycles, therefore the averaging time selection determines the amount of delay that will exist between a steady state change in the ambient light conditions and the associated change of the backlight illumination. For example, the A/D converter samples the ALS inputs at 16kHz. If the averaging time is set to 800ms, the Averager will send the updated zone information to the discriminator every 800ms. This zone information contains the average of approximately 12800 samples (800ms \times 16kHz). Due to the latency of 2 averaging cycles, when there is a steady state change in the ambient light, the LED current will begin to transition to the appropriate target value after approximately 1600ms have elapsed.

The sign and magnitude of these Averager outputs are used to determine whether the LM3535 should change brightness zones. The Averager block follows the following rules to make a zone transition:

- The Averager always begins with a Zone0 reading stored at start-up. If the main display LEDs are active before the ALS block is enabled, it is recommended that the ALS-EN bit be enabled at least 3 averaging cycles times before the ALS-ENA bit is enabled.
- The Averager will always round down to the lower zone in the case of a non-integer zone average (1.2 rounds to 1 and 1.75 also rounds to 1). [Figure 16](#) shows an example of how the Averager will make the zone decisions for different Ambient conditions.

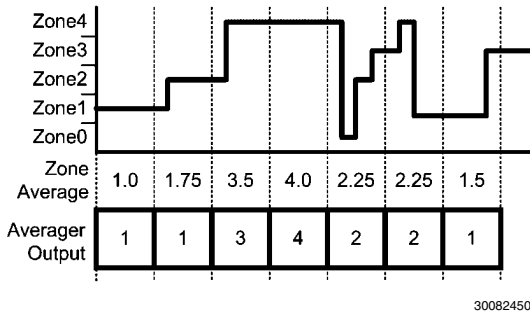

FIGURE 16. Averager Calculation

- The two most current averaging samples are used to make zone change decisions.
- To make a zone change, data from three averaging cycles are needed. (Starting Value, First Transition, Second Transition or Rest)
- To Increase the brightness zone, a positive Averager zone output must be followed by a second positive Averager output or a repeated Averager zone. ('+' to '+' or '+' to 'Rest')
- To decrease the brightness zone, a negative Averager zone output must be followed by a second negative Averager output or a repeated Averager zone. ('-' to '-' or '-' to 'Rest')
- In the case of two increases or decreases in the Averager output, the LM3535 will transition to zone equal to the last Averager output.

Figure 17 provides a graphical representation of the Averager's behavior.

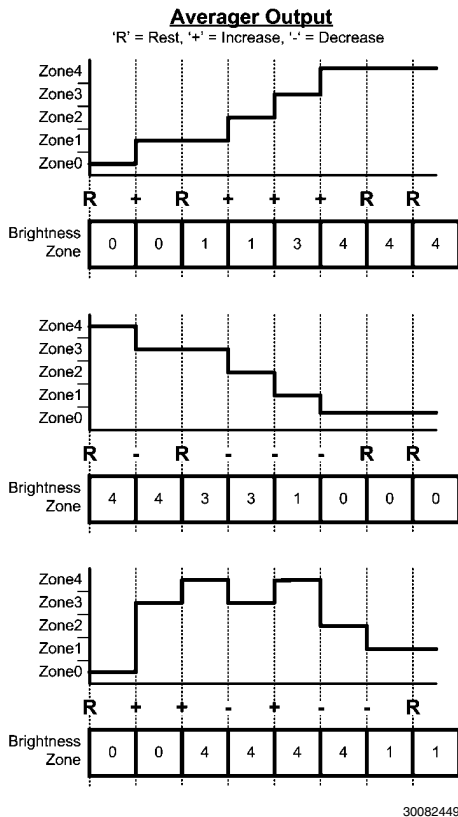

FIGURE 17. Brightness Zone Change Examples

Using the diagram for the ALS block (Figure 14), Figure 18 shows the flow of information starting with the A/D, transitioning to the Averager, followed by the Discriminator. Each state filters the previous output to help prevent unwanted zone to zone transitions.

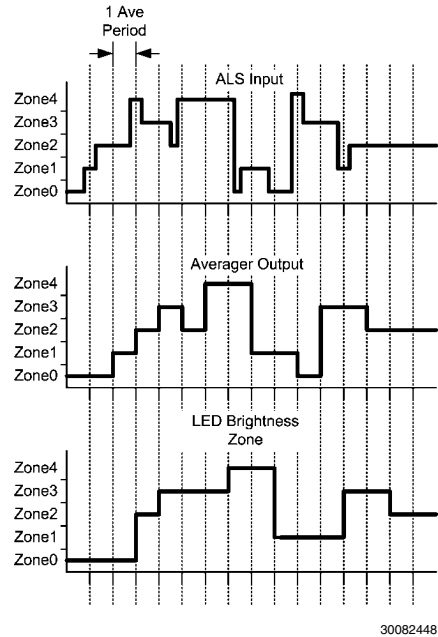

FIGURE 18. Ambient Light Input to Backlight Mapping

When using the ALS averaging functionality, it is important to remember that the averaging cycle is free running and is not synchronized with changing ambient lighting conditions. Due to the nature of the Averager round down, an increase in brightness can take between 2 and 3 averaging cycles to change zones while a decrease in brightness can take between 1 and 2 averaging cycles to change. See Figure 9 for a list of possible Averager periods. Figure 19 shows an example of how the perceived brightness change time can vary.

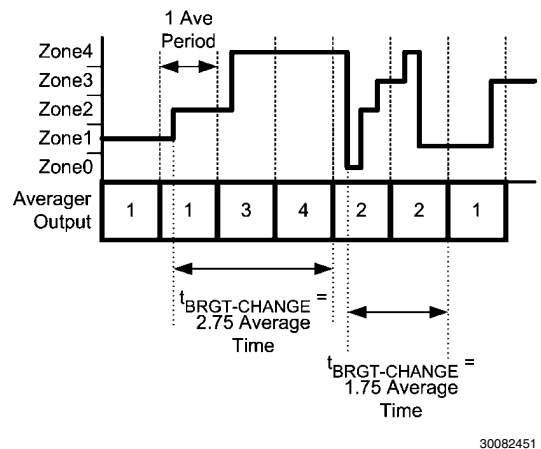
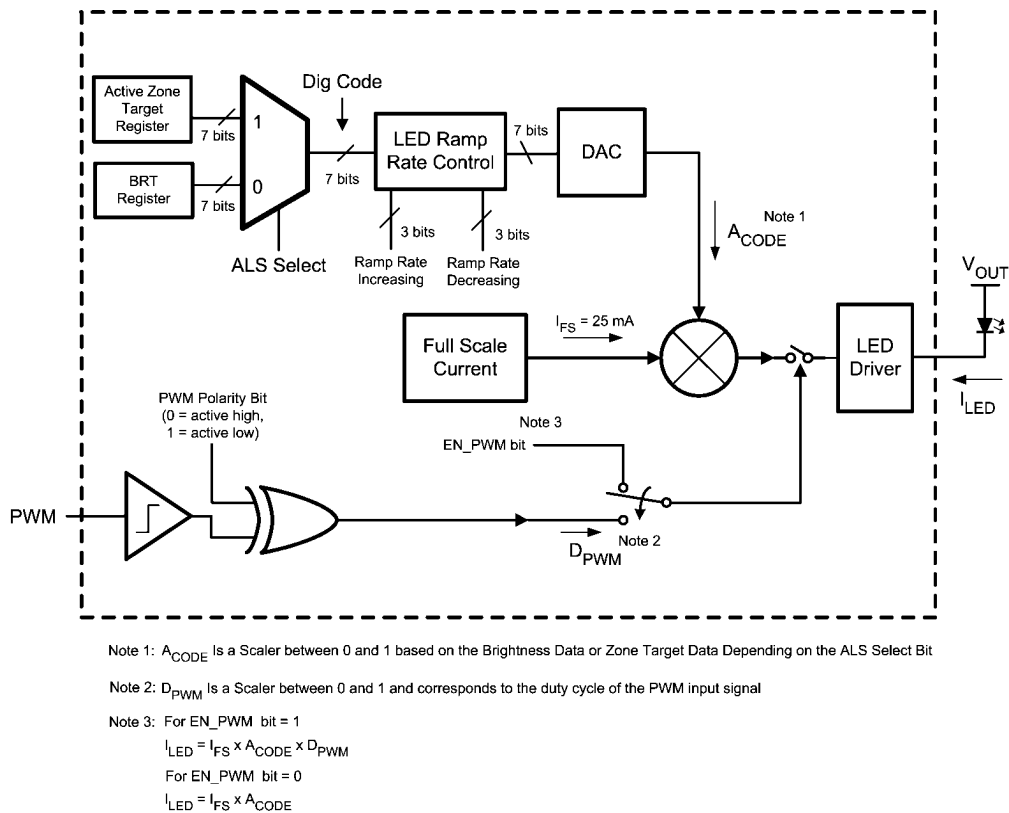

FIGURE 19. Perceived Brightness Change Time

Ambient Light Current Control + PWM

The Ambient Light Current Control can also be a function of the PWM input duty cycle. Assume the LM3535 is configured as described in the previous example, but this time the Enable

PWM bit set to '1' (Configuration Register bit [0]). *Figure 20* shows how the different blocks (PWM and ALS) influence the LED current.



30082446

FIGURE 20. Current Control Block Diagram

ALS + PWM Example

In this example, the APDS-9005 sensor detects that the ambient light has changed to 1 kLux. The voltage at the ALS input is now around 875mV and the ambient light falls within Zone 5. This causes the LED brightness to be a function of Zone Target Register 5 (loaded with 0x7F). Now assume the PWM input is also driven with a 50% duty cycle pulsed waveform. The LED current now becomes:

$$I_{LED} = I_{LED_FS} \times ZoneTarget5 \times D = 25 \text{ mA} \times 100\% \times 50\% \approx 12.5 \text{ mA}$$

LED CONFIGURATIONS

The LM3535 has a total of 8 current sinks capable of sinking 200mA of total diode current. These 8 current sinks are configured to operate in three independently controlled lighting regions. GroupA has four dedicated current sinks, while GroupB and GroupC each have one. To add greater lighting flexibility, the LM3535 has two additional drivers (D53 and D62) that can be assigned to either GroupA or GroupB through a setting in the general purpose register.

At start-up, the default condition is four LEDs in GroupA, three LEDs in GroupB and a single LED in GroupC (NOTE: GroupC only consists of a single current sink (D1C) under any configuration). Bits 53A and 62A in the general purpose register control where current sinks D53 and D62 are assigned. By writing a '1' to the 53A or 62A bits, D53 and D62 become assigned to the GroupA lighting region. Writing a '0' to these bits

assigns D53 and D62 to the GroupB lighting region. With this added flexibility, the LM3535 is capable of supporting applications requiring 4, 5, or 6 LEDs for main display lighting, while still providing additional current sinks that can be used for a wide variety of lighting functions.

MAXIMUM OUTPUT CURRENT, MAXIMUM LED VOLTAGE, MINIMUM INPUT VOLTAGE

The LM3535 can drive 8 LEDs at 25mA each (GroupA, GroupB, GroupC) from an input voltage as low as 3.2V, so long as the LEDs have a forward voltage of 3.6V or less (room temperature).

The statement above is a simple example of the LED drive capability of the LM3535. The statement contains the key application parameters that are required to validate an LED-drive design using the LM3535: LED current (I_{LEDx}), number of active LEDs (N_x), LED forward voltage (V_{LED}), and minimum input voltage (V_{IN-MIN}).

The equation below can be used to estimate the maximum output current capability of the LM3535:

$$I_{LED_MAX} = \frac{[(1.5 \times V_{IN}) - V_{LED} - (I_{ADDITIONAL} \times R_{OUT})]}{[(N_x \times R_{OUT}) + k_{HRx}] \text{ (eq. 1)}}$$

$$I_{LED_MAX} = \frac{[(1.5 \times V_{IN}) - V_{LED} - (I_{ADDITIONAL} \times 2.4\Omega)]}{[(N_x \times 2.4\Omega) + k_{HRx}]}$$

$I_{ADDITIONAL}$ is the additional current that could be delivered to the other LED Groups.

R_{OUT} – Output resistance. This parameter models the internal losses of the charge pump that result in voltage droop at the pump output V_{OUT}. Since the magnitude of the voltage droop is proportional to the total output current of the charge pump, the loss parameter is modeled as a resistance. The output resistance of the LM3535 is typically 2.4Ω (V_{IN} = 3.6V, T_A = 25°C). In equation form:

$$V_{VOUT} = (1.5 \times V_{IN}) - \frac{[(N_A \times I_{LEDA} + N_B \times I_{LEDB} + N_C \times I_{LEDC}) \times R_{OUT}]}{\quad} \quad (\text{eq. 2})$$

k_{HR} – Headroom constant. This parameter models the minimum voltage required to be present across the current sinks for them to regulate properly. This minimum voltage is proportional to the programmed LED current, so the constant has units of mV/mA. The typical k_{HR} of the LM3535 is 4mV/mA. In equation form:

$$(V_{VOUT} - V_{LEDx}) > k_{HRx} \times I_{LEDx} \quad (\text{eq. 3})$$

Typical Headroom Constant Values

$$k_{HRA} = k_{HRB} = k_{HRC} = 4 \text{ mV/mA}$$

The "I_{LED-MAX}" equation (eq. 1) is obtained from combining the R_{OUT} equation (eq. 2) with the k_{HRx} equation (eq. 3) and solving for I_{LEDx}. Maximum LED current is highly dependent on minimum input voltage and LED forward voltage. Output current capability can be increased by raising the minimum input voltage of the application, or by selecting an LED with a lower forward voltage. Excessive power dissipation may also limit output current capability of an application.

Total Output Current Capability

The maximum output current that can be drawn from the LM3535 is 200mA.

DRIVER TYPE	MAXIMUM Dx CURRENT
DxA	25mA per DxA Pin
DxB	25mA per DxB Pin
D1C	25mA

PARALLEL CONNECTED AND UNUSED OUTPUTS

Connecting the outputs in parallel does not affect internal operation of the LM3535 and has no impact on the Electrical Characteristics and limits previously presented. The available diode output current, maximum diode voltage, and all other specifications provided in the Electrical Characteristics table apply to this parallel output configuration, just as they do to the standard LED application circuit.

All Dx current sinks utilize LED forward voltage sensing circuitry to optimize the charge-pump gain for maximum efficiency. Due to the nature of the sensing circuitry, it is not recommended to leave any of the Dx pins open when the current sinks are enabled (ENx bits are set to '1'). Leaving Dx pins unconnected will force the charge-pump into 3/2× mode over the entire V_{IN} range negating any efficiency gain that could have been achieved by switching to 1× mode at higher input voltages.

If the D1B or D1C drivers are not going to be used, make sure that the ENB and ENC bits in the general purpose register are set to '0' to ensure optimal efficiency.

POWER EFFICIENCY

Efficiency of LED drivers is commonly taken to be the ratio of power consumed by the LEDs (P_{LED}) to the power drawn at the input of the part (P_{IN}). With a 3/2× - 1× charge pump, the input current is equal to the charge pump gain times the output current (total LED current). The efficiency of the LM3535 can be predicted as follow:

$$P_{LEDTOTAL} = (V_{LEDA} \times N_A \times I_{LEDA}) + (V_{LEDB} \times N_B \times I_{LEDB}) + (V_{LEDC} \times I_{LEDC})$$

$$P_{IN} = V_{IN} \times I_{IN}$$

$$P_{IN} = V_{IN} \times (\text{GAIN} \times I_{LEDTOTAL} + I_Q)$$

$$E = (P_{LEDTOTAL} \div P_{IN})$$

The LED voltage is the main contributor to the charge-pump gain selection process. Use of low forward-voltage LEDs (3.0V- to 3.5V) will allow the LM3535 to stay in the gain of 1× for a higher percentage of the lithium-ion battery voltage range when compared to the use of higher forward voltage LEDs (3.5V to 4.0V). See the *LED Forward Voltage Monitoring* section of this datasheet for a more detailed description of the gain selection and transition process.

For an advanced analysis, it is recommended that power consumed by the circuit (V_{IN} × I_{IN}) for a given load be evaluated rather than power efficiency.

POWER DISSIPATION

The power dissipation (P_{DISS}) and junction temperature (T_J) can be approximated with the equations below. P_{IN} is the power generated by the 3/2× - 1× charge pump, P_{LED} is the power consumed by the LEDs, T_A is the ambient temperature, and θ_{JA} is the junction-to-ambient thermal resistance for the micro SMD 20-bump package. V_{IN} is the input voltage to the LM3535, V_{LED} is the nominal LED forward voltage, N is the number of LEDs and I_{LED} is the programmed LED current.

$$P_{DISS} = P_{IN} - P_{LEDA} - P_{LEDB} - P_{LEDC}$$

$$P_{DISS} = (\text{GAIN} \times V_{IN} \times I_{\text{GroupA} + \text{GroupB} + \text{GroupC}}) - (V_{LEDA} \times N_A \times I_{LEDA}) - (V_{LEDB} \times N_B \times I_{LEDB}) - (V_{LEDC} \times I_{LEDC})$$

$$T_J = T_A + (P_{DISS} \times \theta_{JA})$$

The junction temperature rating takes precedence over the ambient temperature rating. The LM3535 may be operated outside the ambient temperature rating, so long as the junction temperature of the device does not exceed the maximum operating rating of 110°C. The maximum ambient temperature rating must be derated in applications where high power dissipation and/or poor thermal resistance causes the junction temperature to exceed 110°C.

THERMAL PROTECTION

Internal thermal protection circuitry disables the LM3535 when the junction temperature exceeds 150°C (typ.). This feature protects the device from being damaged by high die temperatures that might otherwise result from excessive power dissipation. The device will recover and operate normally when the junction temperature falls below 125°C (typ.). It is important that the board layout provide good thermal conduction to keep the junction temperature within the specified operating ratings.

CAPACITOR SELECTION

The LM3535 requires 4 external capacitors for proper operation (C₁ = C₂ = C_{IN} = C_{OUT} = 1μF). Surface-mount multi-layer ceramic capacitors are recommended. These capacitors are small, inexpensive and have very low equivalent series resistance (ESR <20mΩ typ.). Tantalum capacitors, OS-CON capacitors, and aluminum electrolytic capacitors are not recommended for use with the LM3535 due to their high ESR, as compared to ceramic capacitors.

For most applications, ceramic capacitors with X7R or X5R temperature characteristic are preferred for use with the LM3535. These capacitors have tight capacitance tolerance (as good as ±10%) and hold their value over temperature

(X7R: $\pm 15\%$ over -55°C to 125°C ; X5R: $\pm 15\%$ over -55°C to 85°C).

Capacitors with Y5V or Z5U temperature characteristic are generally not recommended for use with the LM3535. Capacitors with these temperature characteristics typically have wide capacitance tolerance ($+80\%$, -20%) and vary significantly over temperature (Y5V: $+22\%$, -82% over -30°C to

$+85^{\circ}\text{C}$ range; Z5U: $+22\%$, -56% over $+10^{\circ}\text{C}$ to $+85^{\circ}\text{C}$ range). Under some conditions, a nominal $1\mu\text{F}$ Y5V or Z5U capacitor could have a capacitance of only $0.1\mu\text{F}$. Such detrimental deviation is likely to cause Y5V and Z5U capacitors to fail to meet the minimum capacitance requirements of the LM3535.

The recommended voltage rating for the capacitors is 10V to account for DC bias capacitance losses.

Physical Dimensions inches (millimeters) unless otherwise noted

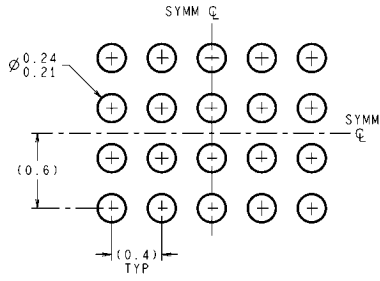

LAND PATTERN RECOMMENDATION

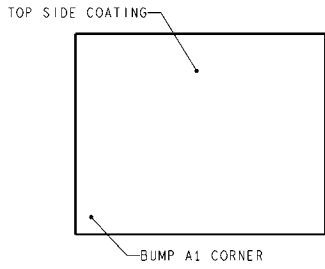

DIMENSIONS ARE IN MILLIMETERS
DIMENSIONS IN () FOR REFERENCE ONLY

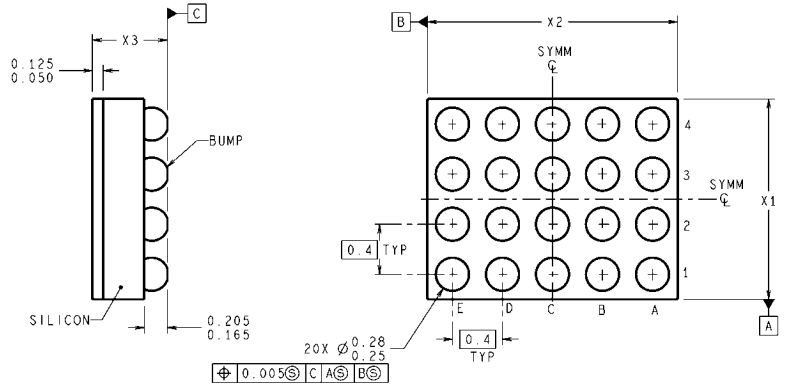

TMD20AAA: 20 Bump 0.4mm micro SMD
X1 = 1.650mm
X2 = 2.055mm
X3 = 0.6mm

TMD20XXX (Rev D)

Notes

Notes

For more National Semiconductor product information and proven design tools, visit the following Web sites at:
www.national.com

Products		Design Support	
Amplifiers	www.national.com/amplifiers	WEBENCH® Tools	www.national.com/webench
Audio	www.national.com/audio	App Notes	www.national.com/appnotes
Clock and Timing	www.national.com/timing	Reference Designs	www.national.com/refdesigns
Data Converters	www.national.com/adc	Samples	www.national.com/samples
Interface	www.national.com/interface	Eval Boards	www.national.com/evalboards
LVDS	www.national.com/lvds	Packaging	www.national.com/packaging
Power Management	www.national.com/power	Green Compliance	www.national.com/quality/green
Switching Regulators	www.national.com/switchers	Distributors	www.national.com/contacts
LDOs	www.national.com/ldo	Quality and Reliability	www.national.com/quality
LED Lighting	www.national.com/led	Feedback/Support	www.national.com/feedback
Voltage References	www.national.com/vref	Design Made Easy	www.national.com/easy
PowerWise® Solutions	www.national.com/powerwise	Applications & Markets	www.national.com/solutions
Serial Digital Interface (SDI)	www.national.com/sdi	Mil/Aero	www.national.com/milaero
Temperature Sensors	www.national.com/tempensors	SolarMagic™	www.national.com/solarmagic
PLL/VCO	www.national.com/wireless	PowerWise® Design University	www.national.com/training

THE CONTENTS OF THIS DOCUMENT ARE PROVIDED IN CONNECTION WITH NATIONAL SEMICONDUCTOR CORPORATION ("NATIONAL") PRODUCTS. NATIONAL MAKES NO REPRESENTATIONS OR WARRANTIES WITH RESPECT TO THE ACCURACY OR COMPLETENESS OF THE CONTENTS OF THIS PUBLICATION AND RESERVES THE RIGHT TO MAKE CHANGES TO SPECIFICATIONS AND PRODUCT DESCRIPTIONS AT ANY TIME WITHOUT NOTICE. NO LICENSE, WHETHER EXPRESS, IMPLIED, ARISING BY ESTOPPEL OR OTHERWISE, TO ANY INTELLECTUAL PROPERTY RIGHTS IS GRANTED BY THIS DOCUMENT.

TESTING AND OTHER QUALITY CONTROLS ARE USED TO THE EXTENT NATIONAL DEEMS NECESSARY TO SUPPORT NATIONAL'S PRODUCT WARRANTY. EXCEPT WHERE MANDATED BY GOVERNMENT REQUIREMENTS, TESTING OF ALL PARAMETERS OF EACH PRODUCT IS NOT NECESSARILY PERFORMED. NATIONAL ASSUMES NO LIABILITY FOR APPLICATIONS ASSISTANCE OR BUYER PRODUCT DESIGN. BUYERS ARE RESPONSIBLE FOR THEIR PRODUCTS AND APPLICATIONS USING NATIONAL COMPONENTS. PRIOR TO USING OR DISTRIBUTING ANY PRODUCTS THAT INCLUDE NATIONAL COMPONENTS, BUYERS SHOULD PROVIDE ADEQUATE DESIGN, TESTING AND OPERATING SAFEGUARDS.

EXCEPT AS PROVIDED IN NATIONAL'S TERMS AND CONDITIONS OF SALE FOR SUCH PRODUCTS, NATIONAL ASSUMES NO LIABILITY WHATSOEVER, AND NATIONAL DISCLAIMS ANY EXPRESS OR IMPLIED WARRANTY RELATING TO THE SALE AND/OR USE OF NATIONAL PRODUCTS INCLUDING LIABILITY OR WARRANTIES RELATING TO FITNESS FOR A PARTICULAR PURPOSE, MERCHANTABILITY, OR INFRINGEMENT OF ANY PATENT, COPYRIGHT OR OTHER INTELLECTUAL PROPERTY RIGHT.

LIFE SUPPORT POLICY

NATIONAL'S PRODUCTS ARE NOT AUTHORIZED FOR USE AS CRITICAL COMPONENTS IN LIFE SUPPORT DEVICES OR SYSTEMS WITHOUT THE EXPRESS PRIOR WRITTEN APPROVAL OF THE CHIEF EXECUTIVE OFFICER AND GENERAL COUNSEL OF NATIONAL SEMICONDUCTOR CORPORATION. As used herein:

Life support devices or systems are devices which (a) are intended for surgical implant into the body, or (b) support or sustain life and whose failure to perform when properly used in accordance with instructions for use provided in the labeling can be reasonably expected to result in a significant injury to the user. A critical component is any component in a life support device or system whose failure to perform can be reasonably expected to cause the failure of the life support device or system or to affect its safety or effectiveness.

National Semiconductor and the National Semiconductor logo are registered trademarks of National Semiconductor Corporation. All other brand or product names may be trademarks or registered trademarks of their respective holders.

Copyright© 2010 National Semiconductor Corporation

For the most current product information visit us at www.national.com



National Semiconductor Americas Technical Support Center
 Email: support@nsc.com
 Tel: 1-800-272-9959

National Semiconductor Europe Technical Support Center
 Email: europe.support@nsc.com

National Semiconductor Asia Pacific Technical Support Center
 Email: ap.support@nsc.com

National Semiconductor Japan Technical Support Center
 Email: jpn.feedback@nsc.com

IMPORTANT NOTICE

Texas Instruments Incorporated and its subsidiaries (TI) reserve the right to make corrections, modifications, enhancements, improvements, and other changes to its products and services at any time and to discontinue any product or service without notice. Customers should obtain the latest relevant information before placing orders and should verify that such information is current and complete. All products are sold subject to TI's terms and conditions of sale supplied at the time of order acknowledgment.

TI warrants performance of its hardware products to the specifications applicable at the time of sale in accordance with TI's standard warranty. Testing and other quality control techniques are used to the extent TI deems necessary to support this warranty. Except where mandated by government requirements, testing of all parameters of each product is not necessarily performed.

TI assumes no liability for applications assistance or customer product design. Customers are responsible for their products and applications using TI components. To minimize the risks associated with customer products and applications, customers should provide adequate design and operating safeguards.

TI does not warrant or represent that any license, either express or implied, is granted under any TI patent right, copyright, mask work right, or other TI intellectual property right relating to any combination, machine, or process in which TI products or services are used. Information published by TI regarding third-party products or services does not constitute a license from TI to use such products or services or a warranty or endorsement thereof. Use of such information may require a license from a third party under the patents or other intellectual property of the third party, or a license from TI under the patents or other intellectual property of TI.

Reproduction of TI information in TI data books or data sheets is permissible only if reproduction is without alteration and is accompanied by all associated warranties, conditions, limitations, and notices. Reproduction of this information with alteration is an unfair and deceptive business practice. TI is not responsible or liable for such altered documentation. Information of third parties may be subject to additional restrictions.

Resale of TI products or services with statements different from or beyond the parameters stated by TI for that product or service voids all express and any implied warranties for the associated TI product or service and is an unfair and deceptive business practice. TI is not responsible or liable for any such statements.

TI products are not authorized for use in safety-critical applications (such as life support) where a failure of the TI product would reasonably be expected to cause severe personal injury or death, unless officers of the parties have executed an agreement specifically governing such use. Buyers represent that they have all necessary expertise in the safety and regulatory ramifications of their applications, and acknowledge and agree that they are solely responsible for all legal, regulatory and safety-related requirements concerning their products and any use of TI products in such safety-critical applications, notwithstanding any applications-related information or support that may be provided by TI. Further, Buyers must fully indemnify TI and its representatives against any damages arising out of the use of TI products in such safety-critical applications.

TI products are neither designed nor intended for use in military/aerospace applications or environments unless the TI products are specifically designated by TI as military-grade or "enhanced plastic." Only products designated by TI as military-grade meet military specifications. Buyers acknowledge and agree that any such use of TI products which TI has not designated as military-grade is solely at the Buyer's risk, and that they are solely responsible for compliance with all legal and regulatory requirements in connection with such use.

TI products are neither designed nor intended for use in automotive applications or environments unless the specific TI products are designated by TI as compliant with ISO/TS 16949 requirements. Buyers acknowledge and agree that, if they use any non-designated products in automotive applications, TI will not be responsible for any failure to meet such requirements.

Following are URLs where you can obtain information on other Texas Instruments products and application solutions:

Products

Audio	www.ti.com/audio
Amplifiers	amplifier.ti.com
Data Converters	dataconverter.ti.com
DLP® Products	www.dlp.com
DSP	dsp.ti.com
Clocks and Timers	www.ti.com/clocks
Interface	interface.ti.com
Logic	logic.ti.com
Power Mgmt	power.ti.com
Microcontrollers	microcontroller.ti.com
RFID	www.ti-rfid.com
OMAP Mobile Processors	www.ti.com/omap
Wireless Connectivity	www.ti.com/wirelessconnectivity

Applications

Communications and Telecom	www.ti.com/communications
Computers and Peripherals	www.ti.com/computers
Consumer Electronics	www.ti.com/consumer-apps
Energy and Lighting	www.ti.com/energy
Industrial	www.ti.com/industrial
Medical	www.ti.com/medical
Security	www.ti.com/security
Space, Avionics and Defense	www.ti.com/space-avionics-defense
Transportation and Automotive	www.ti.com/automotive
Video and Imaging	www.ti.com/video

TI E2E Community Home Page

e2e.ti.com

Mailing Address: Texas Instruments, Post Office Box 655303, Dallas, Texas 75265
Copyright © 2011, Texas Instruments Incorporated