

HDC2010 Low Power Humidity and Temperature Digital Sensors

1 Features

- Relative Humidity Range 0% to 100%
- Humidity Accuracy $\pm 2\%$
- Sleep Current 50nA
- Average Supply Current (1 measurement per second)
 - RH only (11 bit) 300nA
 - RH (11 bit) + Temperature (11 bit) 550nA
- Temperature Range:
 - Operating: -40°C to 85°C
 - Functional: -40°C to 125°C
- Temperature Accuracy: $\pm 0.2^{\circ}\text{C}$ typ.
- Supply Voltage: 1.62 V to 3.6 V
- Automatic Sampling Rate (5 Hz, 2 Hz, 1 Hz, 0.2 Hz, 0.1 Hz, 1/60 Hz, 1/120 Hz) or On Demand
- I²C Interface

2 Applications

- Smart Thermostats
- Smart Home Assistants
- Refrigerators
- Refrigerated Transport
- Washer/Dryers
- HVAC Systems
- Gas Sensing
- Communications Equipment
- Environmental Tags
- Smoke and Heat Detectors
- Inkjet Printers
- Surveillance Cameras
- CPAP Machines
- Wearables

3 Description

The HDC2010 is an integrated humidity and temperature sensor that provides high accuracy measurements with very low power consumption, in an ultra-compact WLCSP (Wafer Level Chip Scale Package). The sensing element of the HDC2010 is placed on the bottom part of the device, which makes the HDC2010 more robust against dirt, dust, and other environmental contaminants. The capacitive-based sensor includes new integrated digital features and a heating element to dissipate condensation and moisture. The HDC2010 digital features include programmable interrupt thresholds to provide alerts/system wakeups without requiring a microcontroller to be continuously monitoring the system. This, combined with programmable sampling intervals, low inherent power consumption, and support for 1.8V supply voltage, make the HDC2010 well suited for battery-operated systems.

The HDC2010 provides high accuracy measurement capability for a wide range of environmental monitoring applications and Internet of Things (IoT) such as smart thermostats, smart home assistants and wearables. The HDC2010 can also be used to provide critical temperature and humidity data for cold chain transportation and storage of perishable goods to help ensure products like food and pharmaceuticals arrive fresh.

The HDC2010 is factory-calibrated to 0.2°C temperature accuracy and 2% relative humidity accuracy and includes a heating element to burn away condensation and moisture for increased reliability. The HDC2010 supports operation from -40°C to 125°C and from 0% to 100% relative humidity.

Device Information⁽¹⁾

PART NUMBER	PACKAGE	BODY SIZE (NOM)
HDC2010	DSBGA (6-bump)	1.5 mm x 1.5 mm x 0.675 mm

(1) For all available packages, see the orderable addendum at the end of the data sheet.

Typical Application

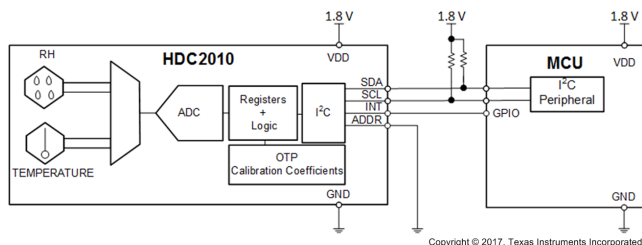

RH Accuracy

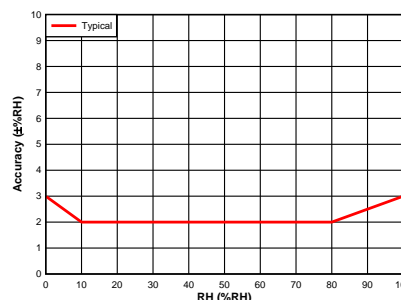

Table of Contents

1 Features	1	7.5 Programming	15
2 Applications	1	7.6 Register Maps	16
3 Description	1	8 Application and Implementation	25
4 Revision History	2	8.1 Application Information	25
5 Pin Configuration and Functions	3	8.2 Typical Application	25
6 Specifications	4	8.3 Do's and Don'ts	26
6.1 Absolute Maximum Ratings	4	9 Power Supply Recommendations	28
6.2 ESD Ratings	4	9.1 Average Current Consumption	28
6.3 Recommended Operating Conditions	4	10 Layout	28
6.4 Thermal Information	4	10.1 Layout Guidelines	28
6.5 Electrical Characteristics	4	10.2 Layout Example	28
6.6 I2C Interface Electrical Characteristics	6	11 Device and Documentation Support	30
6.7 I2C Interface Timing Requirements	6	11.1 Documentation Support	30
6.8 Typical Characteristics	7	11.2 Receiving Notification of Documentation Updates	30
7 Detailed Description	8	11.3 Community Resources	30
7.1 Overview	8	11.4 Trademarks	30
7.2 Functional Block Diagram	8	11.5 Electrostatic Discharge Caution	30
7.3 Feature Description	8	11.6 Glossary	30
7.4 Device Functional Modes	14	12 Mechanical, Packaging, and Orderable Information	31

4 Revision History

DATE	REVISION	NOTES
July 2017	*	Initial release.

5 Pin Configuration and Functions

WLCSP (DSBGA)
6 Pin YPA
Top View

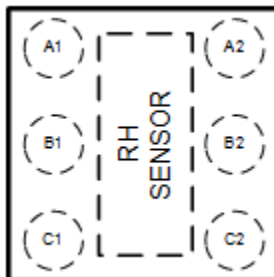

Pin Functions

PIN		I/O TYPE ⁽¹⁾	DESCRIPTION
NAME	NO.		
VDD	A1	P	Positive Supply Voltage
ADDR	B1	I	Address select pin – hardwired to VDD or GND. GND: slave address: 1000000 VDD: slave address: 1000001
GND	C1	G	Ground
SDA	A2	I/O	Serial data line for I ² C, open-drain; requires a pull-up resistor to VDD
SCL	B2	I	Serial clock line for I ² C, open-drain; requires a pull-up resistor to VDD
DRDY / INT	C2	O	Data ready/Interrupt

(1) P=Power, G=Ground, I=Input, O=Output

6 Specifications

6.1 Absolute Maximum Ratings⁽¹⁾

		MIN	MAX	UNIT
VDD	Input Voltage	-0.3	3.9	V
GND	Input Voltage	-0.3	3.9	V
ADDR	Input Voltage	-0.3	3.9	V
SCL	Input Voltage	-0.3	3.9	V
SDA	Input Voltage	-0.3	3.9	V
T _{stg}	Storage temperature	-65	150	°C

- (1) Stresses beyond those listed under *Absolute Maximum Rating* may cause permanent damage to the device. These are stress ratings only, which do not imply functional operation of the device at these or any other conditions beyond those indicated under *Recommended Operating Condition*. Exposure to absolute-maximum-rated conditions for extended periods may affect device reliability.

6.2 ESD Ratings

		VALUE	UNIT
V _(ESD)	Electrostatic discharge	Human body model (HBM), per ANSI/ESDA/JEDEC JS-001, all pins ⁽¹⁾	±2000
		Charged device model (CDM), per JEDEC specification JESD22-C101, all pins ⁽²⁾	±250

- (1) JEDEC document JEP155 states that 500-V HBM allows safe manufacturing with a standard ESD control process.
 (2) JEDEC document JEP157 states that 250-V CDM allows safe manufacturing with a standard ESD control process.

6.3 Recommended Operating Conditions

over operating range (unless otherwise noted)

		MIN	NOM	MAX	UNIT
V _{DD}	Voltage Supply	1.62		3.6	V

6.4 Thermal Information

THERMAL METRIC ⁽¹⁾		HDC2010	UNIT
		DSBGA (YPA)	
		6 PINS	
R _{θJA}	Junction-to-ambient thermal resistance	114.8	°C/W
R _{θJC(top)}	Junction-to-case (top) thermal resistance	0.8	°C/W
R _{θJB}	Junction-to-board thermal resistance	35.2	°C/W
Ψ _{JT}	Junction-to-top characterization parameter	0.6	°C/W
Ψ _{JB}	Junction-to-board characterization parameter	35.4	°C/W

- (1) For more information about traditional and new thermal metrics, see the [Semiconductor and IC Package Thermal Metrics](#) application report.

6.5 Electrical Characteristics

at T_A = 30°C, V_{DD} = 1.8 V, 20% ≤ RH ≤ 80% (unless otherwise noted)

PARAMETER	TEST CONDITIONS	MIN	TYP	MAX	UNIT
ELECTRICAL SPECIFICATION					
V _{DD}	Supply Voltage	Operating Range		1.62	3.6 V

Electrical Characteristics (continued)

at $T_A = 30^\circ\text{C}$, $V_{DD} = 1.8\text{ V}$, $20\% \leq \text{RH} \leq 80\%$ (unless otherwise noted)

PARAMETER		TEST CONDITIONS	MIN	TYP	MAX	UNIT
I_{DD}	Supply current	RH measurement ⁽¹⁾		650	890	μA
		Temperature measurement ⁽¹⁾		550	730	
		Sleep Mode		0.05	0.1	
		Average at 1 measurement/second, RH or temperature only ^{(1) (2)}		0.3		
		Average at 1 measurement/second, RH (11 bit) + temperature (11 bit) ^{(1) (2)}		0.55		
		Average at 1 measurement every 2 seconds, RH (11 bit) + temperature (11 bit) ^{(1) (2)}		0.3		
		Average at 1 measurement every 10 seconds, RH (11 bit) + temperature (11 bit) ^{(1) (2)}		0.105		
I_{DDHEAT}	Heater ⁽³⁾	$V_{DD} = 3.3\text{ V}$		90		mA
RELATIVE HUMIDITY SENSOR						
RH_{ACC}	Accuracy ^{(4) (5) (6)}			± 2	± 3	%RH
RH_{REP}	Repeatability ⁽⁷⁾	14 bit resolution		± 0.1		%RH
RH_{HYS}	Hysteresis ⁽⁸⁾			± 1		%RH
RH_{RT}	Response Time ⁽⁹⁾	$t_{63\% \text{ step}}^{(10)}$		8		s
RH_{CT}	Conversion-time ⁽⁷⁾	9 bit accuracy		275		μs
		11 bit accuracy		400		
		14 bit accuracy		660		
RH_{OR}	Operating range	Non-condensing ⁽¹¹⁾	0		100	%RH
RH_{LTD}	Long-term Drift ⁽¹²⁾			± 0.25		%RH/yr
TEMPERATURE SENSOR						
TEMP_{OR}	Operating range		-40		125	$^\circ\text{C}$
TEMP_{ACC}	Accuracy ⁽⁷⁾	$5^\circ\text{C} < T_A < 60^\circ\text{C}$		± 0.2	± 0.4	$^\circ\text{C}$
TEMP_{REP}	Repeatability ⁽⁷⁾	14 bit resolution		± 0.1		$^\circ\text{C}$
TEMP_{CT}	Conversion-time ⁽⁷⁾	9 bit accuracy		225		μs
		11 bit accuracy		350		
		14 bit accuracy		610		

(1) I2C read/write communication and pull up resistors current through SCL, SDA not included.

(2) Average current consumption while conversion is in progress.

(3) Heater operating range – 40°C to 85°C .

(4) Excludes hysteresis and long-term drift.

(5) Excludes the impact of dust, gas phase solvents and other contaminants such as vapors from packaging materials, adhesives, or tapes, etc.

(6) Limits apply over the humidity operating range 20 to 80% RH (non-condensing) from 0 to 60°C .

(7) This parameter is specified by design and/or characterization and is not tested in production.

(8) The hysteresis value is the difference between an RH measurement in a rising and falling RH environment, at a specific RH point.

(9) Actual response times will vary dependent on system thermal mass and air-flow.

(10) Time for the RH output to change by 63% of the total RH change after a step change in environmental humidity.

(11) Recommended humidity operating range is 20 to 80% RH (non-condensing) over 0 to 60°C . Prolonged operation beyond these ranges may result in a shift of sensor reading, with slow recovery time.

(12) Drift due to aging effects at typical conditions (30°C and 20% to 50% RH). This value may be impacted by dust, vaporized solvents, outgassing tapes, adhesives, packaging materials, etc.

Electrical Characteristics (continued)

at $T_A = 30^\circ\text{C}$, $V_{DD} = 1.8\text{ V}$, $20\% \leq \text{RH} \leq 80\%$ (unless otherwise noted)

PARAMETER		TEST CONDITIONS	MIN	TYP	MAX	UNIT
HUMIDITY AND TEMPERATURE						
ODR	Output Data Rate	Selectable Output data rate	On demand			Hz
			5			
			2			
			1			
			0.2			
			0.1			
			1/60			
			1/120			

6.6 I²C Interface Electrical Characteristics

At $T_A = 30^\circ\text{C}$, $V_{DD} = 3.3\text{ V}$ (unless otherwise noted)

PARAMETER		TEST CONDITIONS	MIN	TYP	MAX	UNIT
V_{IH}	Input High Voltage		$0.7 \times V_{DD}$			V
V_{IL}	Input Low Voltage				$0.3 \times V_{DD}$	V
V_{OL}	Output Low Voltage	Sink current 3 mA			0.4	V
HYS	Hysteresis		$0.1 \times V_{DD}$			V
CIN	Input Capacitance on all digital pins			0.5		pF

6.7 I²C Interface Timing Requirements

At $T_A = 30^\circ\text{C}$, $V_{DD} = 1.8\text{ V}$ (unless otherwise noted)

		MIN	NOM	MAX	UNIT
f_{SCL}	Clock Frequency	10		400	kHz
t_{LOW}	Clock Low Time	1.3			μs
t_{HIGH}	Clock High Time	0.6			μs
t_{SP}	Pulse width of spikes that be suppressed by input filter ⁽¹⁾			50	ns
t_{START}	Shutdown entry delay		10	15	ms

(1) This parameter is specified by design and/or characterization and it is not tested in production.

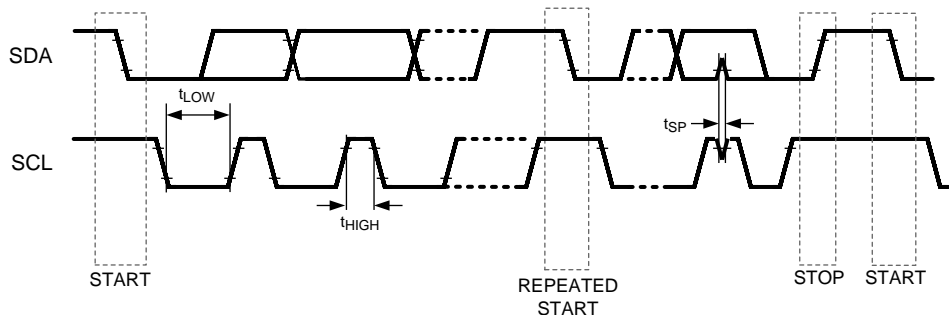

Figure 1. I²C Timing

6.8 Typical Characteristics

Unless otherwise noted. TA = 30°C, VDD = 1.8V.

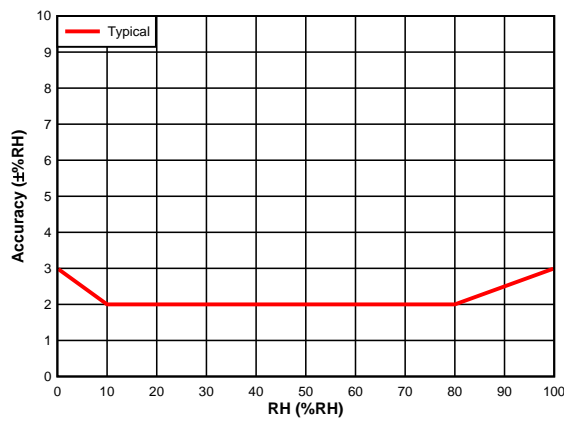

Figure 2. RH Accuracy vs. RH

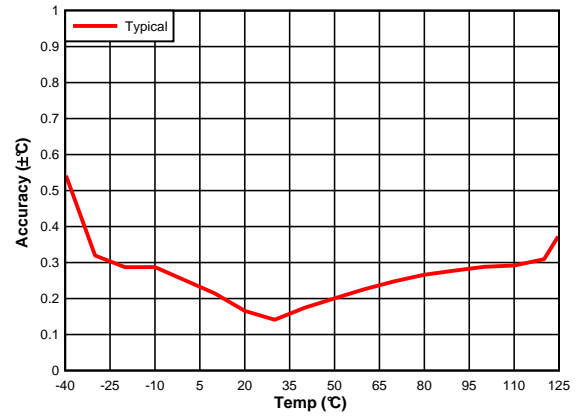

Figure 3. Temperature Accuracy vs. Temperature

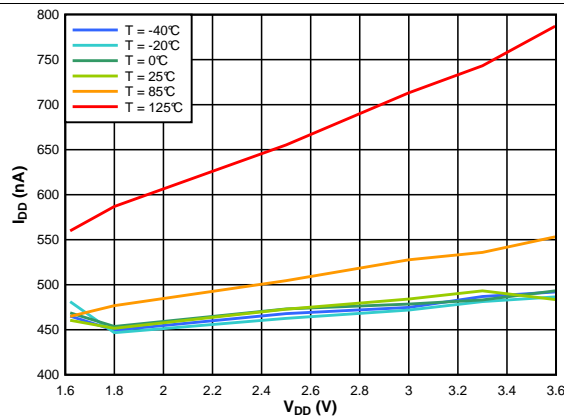

Figure 4. Supply Current vs. Supply Voltage, Average at 1 measurement/second, RH (11bit) + temperature (11 bit)

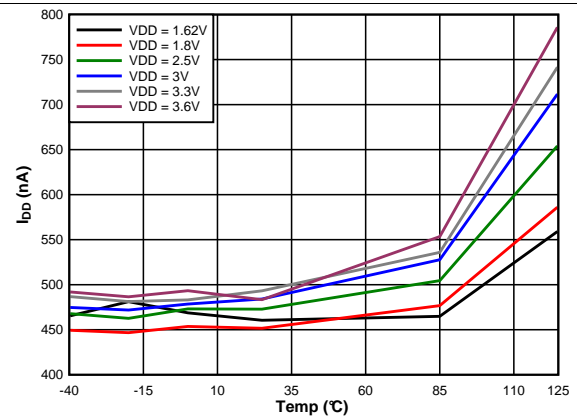

Figure 5. Supply Current vs. Temperature, Average at 1 measurement/second, RH (11bit) + temperature (11 bit)

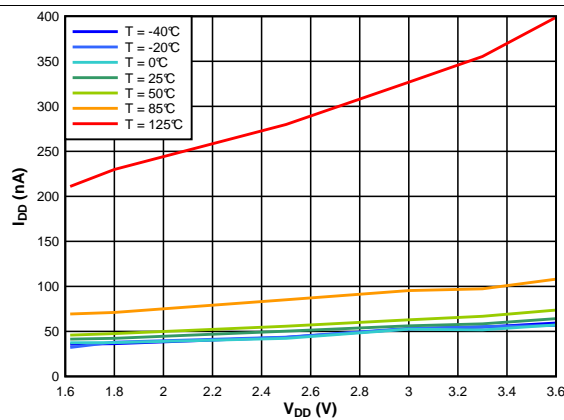

Figure 6. Supply Current vs. Supply Voltage, Sleep Mode

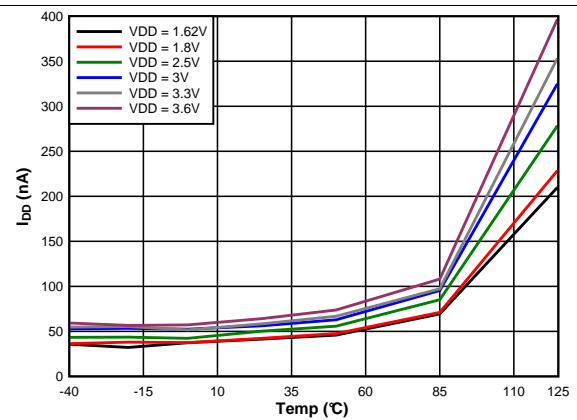

Figure 7. Supply Current vs. Temperature, Sleep Mode

7 Detailed Description

7.1 Overview

The HDC2010 is a digital humidity sensor with integrated temperature sensor that provides excellent measurement accuracy over the long term and at very low power. Measurement results can be read out through the I²C compatible interface. Resolution is based on the measurement time and can be 9, 11, or 14 bits for humidity; 11 or 14 bits for temperature.

7.2 Functional Block Diagram

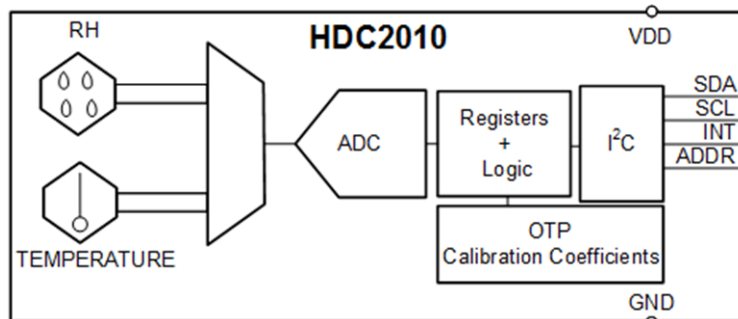

Copyright © 2017, Texas Instruments Incorporated

7.3 Feature Description

7.3.1 Power Consumption

One of the key features of the HDC2010 is its low power consumption, which makes the device suitable in battery or power harvesting applications. In these applications the HDC2010 spends most of the time in sleep mode: with a typical 50nA of current consumption in sleep mode, the averaged current consumption is minimal. Its low consumption in measurement mode minimizes any self-heating.

7.3.2 Heater

The heater is an integrated resistive element that can be used to test the sensor or to drive condensation off the sensor. The heater can be activated using HEAT_EN, bit 3 in the Reset and DRDY/INT Configuration Register (0x0E). The heater helps in reducing the accumulated offset after long exposure at high humidity conditions. The current consumption of the heater is typically 130mA, allowing a temperature increase of about 80°C.

Feature Description (continued)

7.3.3 Interrupt Description

DataReady or interrupt can be generated based on different events and or conditions.

Register 0x07 Interrupt Configuration enable and disable the interrupt/dataready generation based output data and threshold values.

INT/DRDY pins behaviors is related to the interrupt/dataready generation and the 0x0E configuration bits DRDY/INT_EN, INT_POL and INT_MODE

DRDY/INT_EN put in High impedance or enables the INT pin.

INT_POL and INT_MODE define the polarity and the behaviors of the INT signal.

7.3.3.1 DRDY

When DRDY_MASK is set and a humidity and /or temperature conversion is completed the DRDY_STATUS bit is set to 1. Based on the Configuration register settings the DRDY/INT pin behaves in different way. To enable the DRDY pin the DRDY/INT_EN bit (0x0E bit[2]) has to be set to 1 otherwise the pin is put in high impedance.

Bit INT_POL defines the polarity of the DRDY/INT pin.

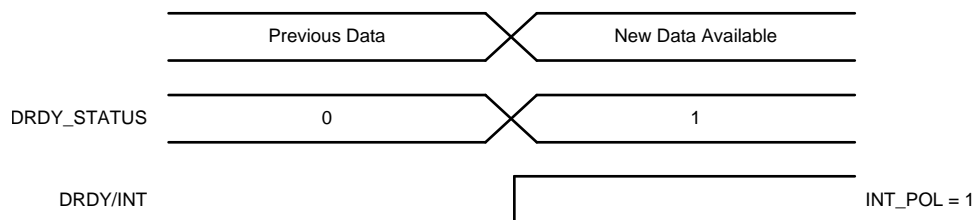

Figure 8. Data Ready Interrupt - Active High (INT_POL = 1)

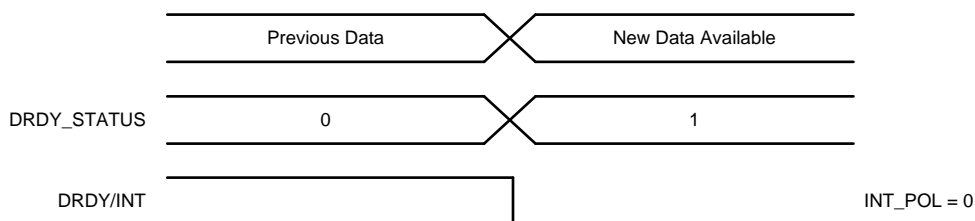

Figure 9. Data Ready Interrupt - Active Low (INT_POL = 0)

Feature Description (continued)

7.3.4 INTERRUPT on Threshold

7.3.4.1 Temperature High

When TH_MASK is set and the temperature is over the threshold value program in the *Temperature Threshold HIGH* register the TH_STATUS bit is set to 1. The TH_STATUS bit and the DRDY/INT pin behave based on the INT_POL and INT_MODE bits.

When INT_MODE set to 1 the TH_STATUS bit remains set to 1 until it is read. The polarity of the DRDY/INT pin is set by INT_POL.

When INT_MODE set to 0 the TH_STATUS bit is based on the current temperature value. The polarity of the DRDY/INT pin is set by INT_POL.

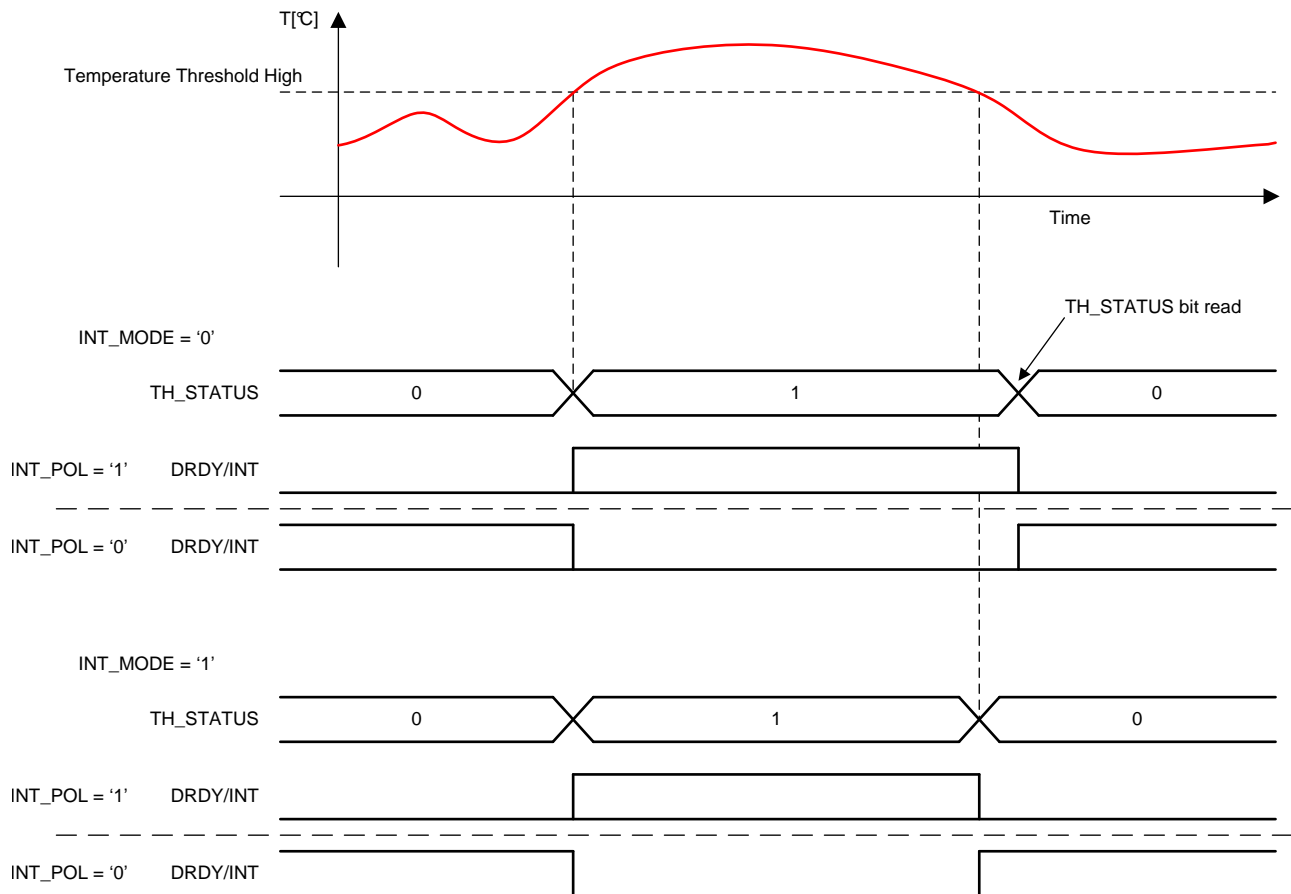

Figure 10. INTERRUPT on Threshold - Temperature High

Feature Description (continued)

7.3.4.2 Temperature Low

When TL_MASK is set and the temperature is under the threshold value program in the *Temperature Threshold LOW* register the TL_STATUS bit is set to 1. The TL_STATUS bit and the DRDY/INT pin behave based on the INT_POL and INT_MODE bits.

When INT_MODE set to 1 the TL_STATUS bit remains set to 1 until it is read. The polarity of the DRDY/INT pin is set by INT_POL.

When INT_MODE set to 0 the TL_STATUS bit is based on the current temperature value. The polarity of the DRDY/INT pin is set by INT_POL.

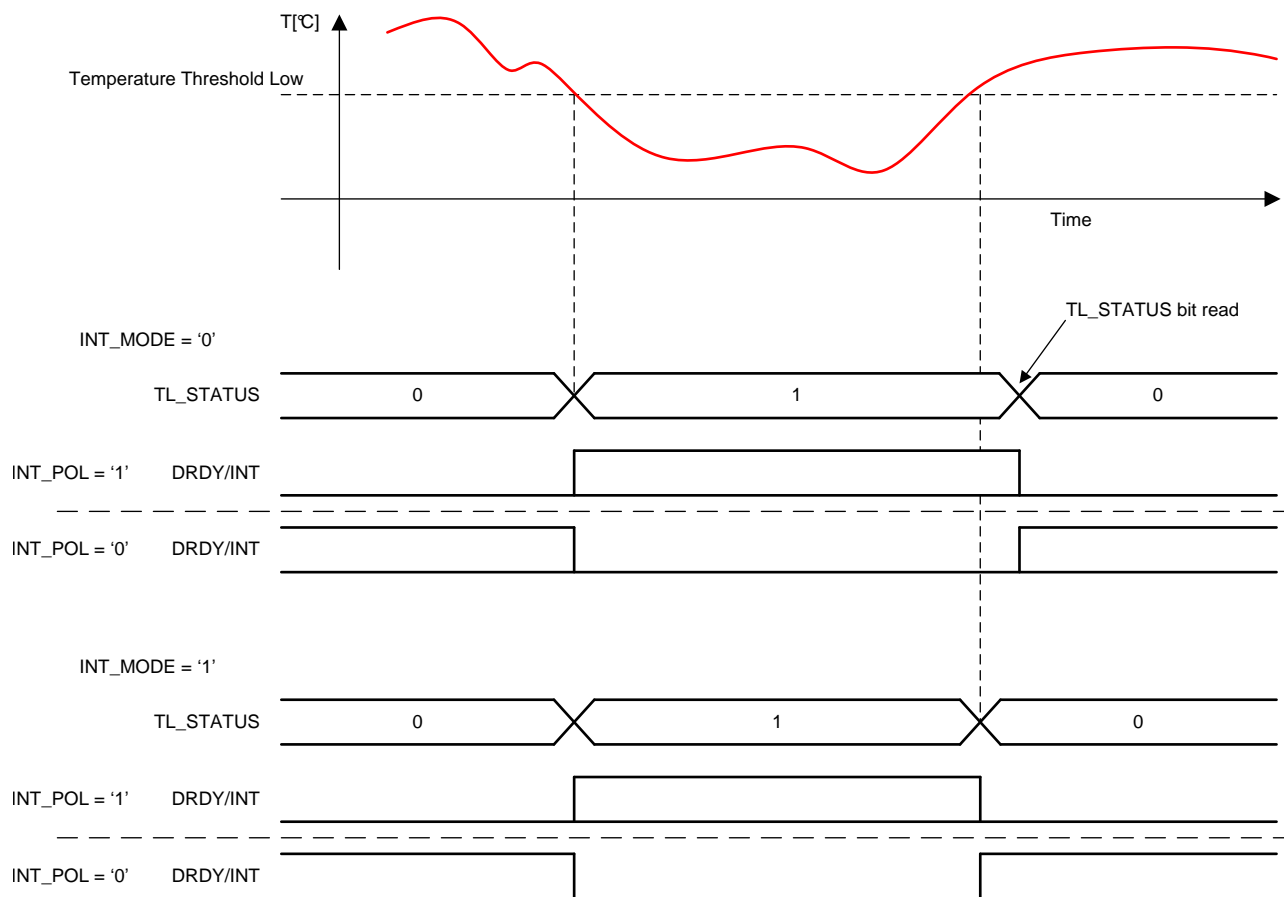

Figure 11. INTERRUPT on Threshold - Temperature Low

Feature Description (continued)
7.3.4.3 Humidity High

When HH_MASK is set and the humidity is over the threshold value program in the *Humidity Threshold HIGH* register the HH_STATUS bit is set to 1. The HH_STATUS bit and the DRDY/INT pin behave based on the INT_POL and INT_MODE bits.

When INT_MODE set to 1 the HH_STATUS bit remains set to 1 until it is read. The polarity of the DRDY/INT pin is set by INT_POL.

When INT_MODE set to 0 the HH_STATUS bit is based on the current humidity value. The polarity of the DRDY/INT pin is set by INT_POL.

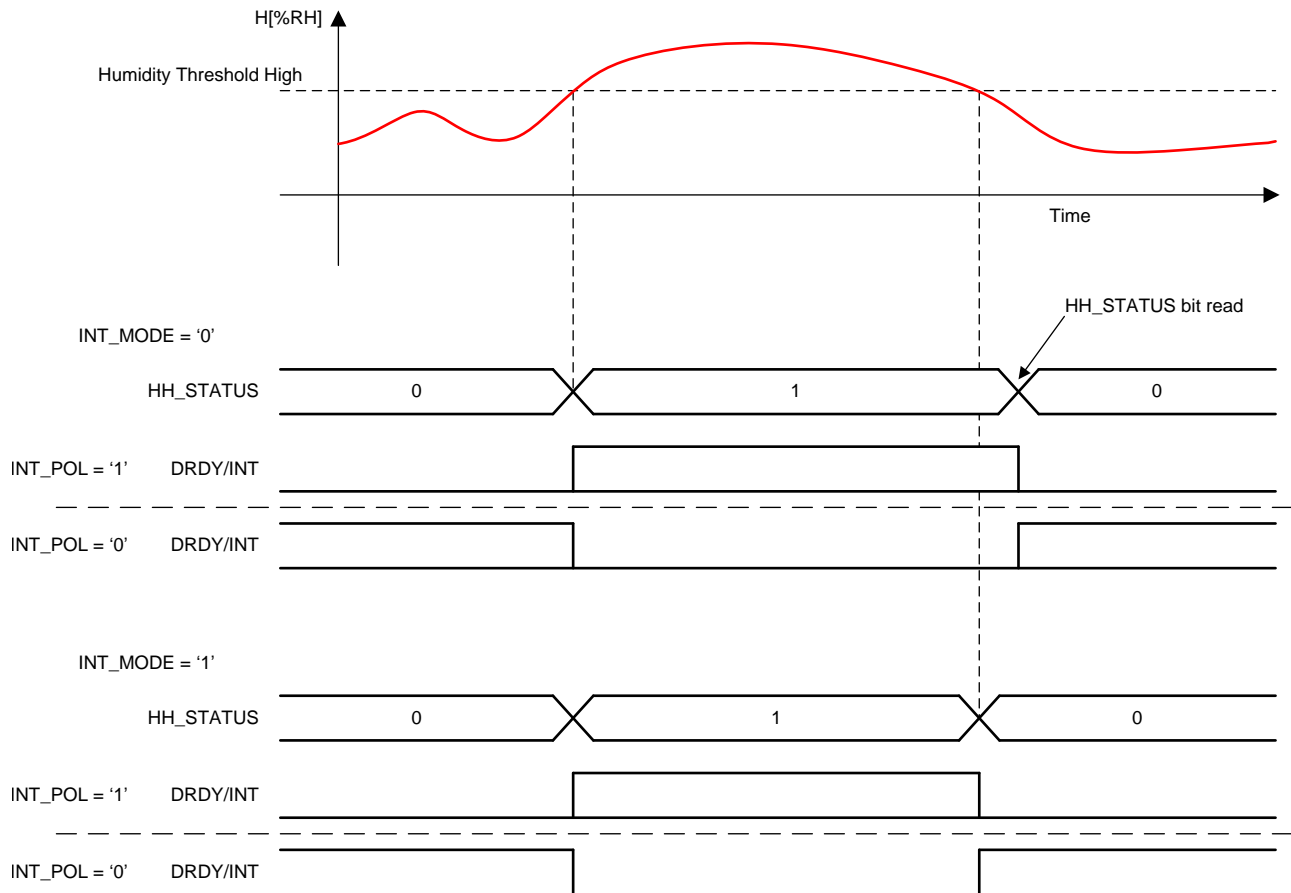

Figure 12. INTERRUPT on Threshold - Humidity High

Feature Description (continued)

7.3.4.4 Humidity Low

When HL_MASK is set and the humidity is over the threshold value program in the *Humidity Threshold LOW* register the HL_STATUS bit is set to 1. The HL_STATUS bit and the DRDY/INT pin behave based on the INT_POL and INT_MODE bits.

When INT_MODE set to 1 the HL_STATUS bit remains set to 1 until it is read. The polarity of the DRDY/INT pin is set by INT_POL.

When INT_MODE set to 0 the HL_STATUS bit is based on the current humidity value. The polarity of the DRDY/INT pin is set by INT_POL.

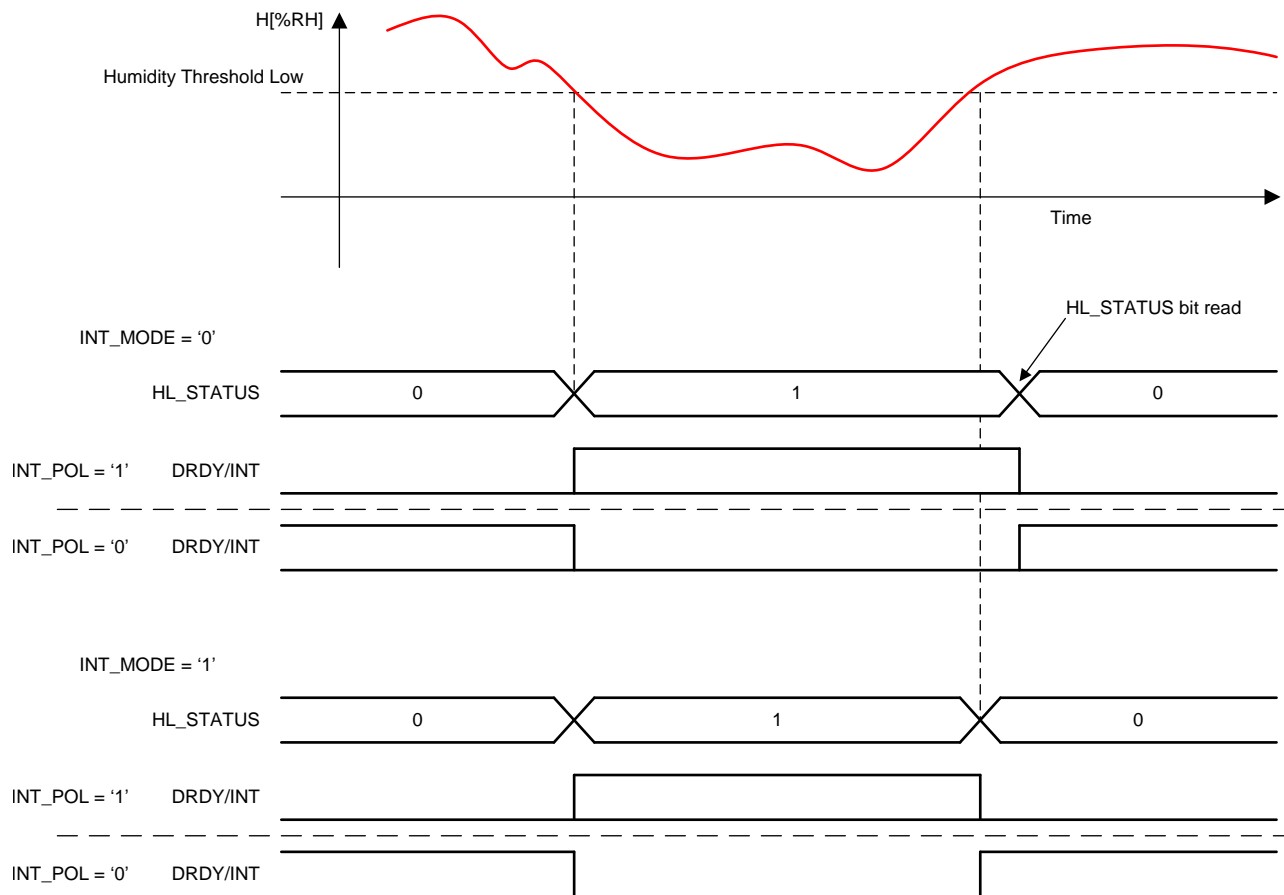

Figure 13. INTERRUPT on Threshold - Humidity Low

Feature Description (continued)

7.3.5 INTERRUPT MODE

Two possible selectable Interrupt Mode are available.

7.3.5.1 Comparator mode

When INT_MODE is set to 1 is possible to activate one or more thresholds at the same time.

The HL_STATUS bit remains set to 1 until it is read. The polarity of the DRDY/INT pin is set by INT_POL.

7.3.5.2 Level Mode

When INT_MODE is set to 0 is possible to activate only one threshold at time

The HL_STATUS bit is based on the current humidity value. The polarity of the DRDY/INT pin is set by INT_POL.

7.4 Device Functional Modes

The HDC2010 has two modes of operation: sleep mode and measurement mode. After power up, the HDC2010 is in sleep mode. In this mode, the HDC2010 waits for I²C inputs including commands to configure the conversion times, trigger a measurement, set the ODR and read measurements. Once it receives a command to trigger a measurement, the HDC2010 moves from sleep mode to measurement mode. In measurement mode, the HDC2010 acquires the configured measurements and sets the DRDY/INT pin. After completing the measurement, the HDC2010 returns to sleep mode.

HDC2010 has two measurement trigger modes: On-Demand and automatic Output Data Rate.

In the On-Demand mode an I²C command triggers the conversion. In the automatic Output Data Rate a conversion frequency is configured among 7 different possibilities (from 5 samples per second down to 1 sample every 2 minutes). HDC2010 moves from sleep to measurement mode automatically based on the selected data rate. At the end of the conversion, the new data overwrites the previous output data.

7.5 Programming

7.5.1 I²C Serial Bus Address Configuration

To communicate with the HDC2010, the master must first address slave devices through a slave address byte. The slave address byte consists of seven address bits and a direction bit that indicates the intent to execute a read or write operation. The HDC2010 features an address pin to allow up to 2 devices to be addressed on a single bus. [Table 1](#) describes the pin logic levels used to connect up to two devices. ADDR must be set before any activity on the interface occurs and remain constant while the device is powered up.

Table 1. HDC2010 I²C Slave Address

ADRO	ADDRESS (7-BIT ADDRESS)
0	1000000
1	1000001

7.5.2 I²C Interface

The HDC2010 operates only as a slave device on the I²C bus interface. It is not allowed to have multiple devices on the same I²C bus with the same address. Connection to the bus is made through the open-drain I/O lines, SDA, and SCL. The SDA and SCL pins feature integrated spike-suppression filters and Schmitt triggers to minimize the effects of input spikes and bus noise. After power-up, the sensor needs at most 3 ms, to be ready to start RH and temperature measurement. After the power-up the sensor is in the sleep mode until a communication or measurement is performed. All data bytes are transmitted MSB first.

7.5.3 Serial Bus Address

To communicate with the HDC2010, the master must first address slave devices through a slave address byte. The slave address byte consists of seven address bits, and a direction bit that indicates the intent to execute a read or write operation.

7.5.4 Read and Write Operations

To access a particular register on the HDC2010, by writing the appropriate value to the register address. The register address value is the first byte transferred after the device slave address byte with the R/W bit low. Every write operation to the HDC2010 requires a value for the register address (refer to [Table 2](#)).

When reading from the HDC2010, the last value stored in the register address by a write operation is used to determine which register is read by a read operation. To change the address for a read operation, a new value must be written to the pointer. This transaction is accomplished by issuing the slave address byte with the R/W bit low, followed by the pointer byte. No additional data is required (refer to [Table 3](#)).

The master can then generate a START condition and send the slave address byte with the R/W bit high to initiate the read command. The address value is incremented automatically enabling the multibyte read and write operation (refer to [Table 4](#) and [Table 5](#)). Note that register bytes are sent MSB first, followed by the LSB. A write operation in a read-only register such as (DEVICE ID, MANUFACTURER ID, SERIAL ID) returns a NACK after each data byte; read/write operation to unused address returns a NACK after the pointer; a read/write operation with incorrect I²C address returns a NACK after the I²C address.

Table 2. Write Single Byte

Master	START	Slave address (W)		Address		DATA		STOP
Slave			ACK		ACK		ACK	

Table 3. Write Multi Byte

Master	START	Slave address (W)		Address		DATA		DATA		STOP
Slave			ACK		ACK		ACK		ACK

Table 4. Read Single Byte

Master	START	Slave address (W)		Address		Start	Slave address (W)			NACK	STOP
Slave			ACK		ACK			ACK	DATA		

Table 5. Read Multi Byte

Master	START	Slave address (W)		Address		Start	Slave address (W)			ACK		ACK	NACK	STOP
Slave			ACK		ACK			ACK	DATA		DATA				

7.6 Register Maps

The HDC2010 contains data registers that hold configuration information, temperature and humidity measurement results, and status information

Table 6. Register Map

ADDRESS (HEX)	NAME	RESET VALUE	DESCRIPTION
0x00	TEMPERATURE LOW	0	Temperature [7:0]
0x01	TEMPERATURE HIGH	0	Temperature [15:8]
0x02	HUMIDITY LOW	0	Humidity [7:0]
0x03	HUMIDITY HIGH	0	Humidity [15:8]
0x04	INTERRUPT/DRDY	0	DataReady and interrupt configuration
0x05	TEMPERATURE MAX	0	Max temperature value measured (peak detector)
0x06	HUMIDITY MAX	0	Max humidity value measured (peak detector)
0x07	INTERRUPT MASK	0	Interrupt Mask
0x08	TEMP_OFFSET_ADJUST	0	Temperature offset adjustment
0x09	HUM_OFFSET_ADJUST	0	Humidity offset adjustment
0x0A	TEMP_THR_L	11111111	Temperature Threshold Low
0x0B	TEMP_THR_H	0	Temperature Threshold High
0x0C	RH_THR_L	11111111	Humidity threshold Low
0x0D	RH_THR_H	0	Humidity threshold High
0x0E	RESET&DRDY/INT CONF	0	Soft Reset and Interrupt Configuration
0x0F	MEASUREMENT CONF	0	Measurement configuration
0xFC	MANUFACTURER ID LOW	01001001	Manufacturer ID Low
0xFD	MANUFACTURER ID HIGH	01010100	Manufacturer ID High
0xFE	DEVICE ID LOW	11010000	Device ID Low
0xFF	DEVICE ID HIGH	00000111	Device ID High

7.6.1 Address 0x00 Temperature LSB

Table 7. Address 0x00 Temperature LSB Register

7	6	5	4	3	2	1	0
TEMP[7:0]							

Table 8. Address 0x00 Temperature LSB Field Descriptions

BIT	FIELD	TYPE	RESET	DESCRIPTION
[7:0]	TEMPERATURE [7:0]	R	00000000	Temperature LSB

7.6.2 Address 0x01 Temperature MSB

Table 9. Address 0x01 Temperature MSB Register

7	6	5	4	3	2	1	0
TEMP[15:8]							

Table 10. Address 0x01 Temperature MSB Field Descriptions

BIT	FIELD	TYPE	RESET	DESCRIPTION
[15:8]	TEMPERATURE [15:8]	R	00000000	Temperature MSB

The temperature register is a 16-bit result register in binary format (the 2 LSBs D1 and D0 are always 0). The result of the acquisition is always a 14 bit value, while the resolution is related to one selected in Measurement Configuration register. The temperature can be calculated from the output data with:

$$\text{Temperature (}^{\circ}\text{C)} = \left(\frac{\text{TEMPERATURE [15:0]}}{2^{16}} \right) \times 165 - 40 \quad (1)$$

7.6.3 Address 0x02 Humidity LSB

Table 11. Address 0x02 Humidity LSB Register

7	6	5	4	3	2	1	0
HUMIDITY[7:0]							

Table 12. Address 0x02 Humidity LSB Field Descriptions

BIT	FIELD	TYPE	RESET	DESCRIPTION
[7:0]	HUMIDITY [7:0]	R	00000000	Humidity LSB

7.6.4 Address 0x03 Humidity MSB

Table 13. Address 0x03 Humidity MSB Register

7	6	5	4	3	2	1	0
HUMIDITY[15:8]							

Table 14. Address 0x03 Humidity MSB Field Descriptions

BIT	FIELD	TYPE	RESET	DESCRIPTION
[15:8]	HUMIDITY[15:8]	R	00000000	Humidity MSB

The humidity register is a 16-bit result register in binary format (the 2 LSBs D1 and D0 are always 0). The result of the acquisition is always a 14 bit value, while the resolution is related to one selected in Measurement Configuration register. The humidity can be calculated from the output data with:

$$\text{Humidity (\%RH)} = \left(\frac{\text{HUMIDITY [15:0]}}{2^{16}} \right) \times 100 \quad (2)$$

7.6.5 Address 0x04 Interrupt DRDY

Table 15. Address 0x04 Interrupt DRDY Register

7	6	5	4	3	2	1	0
DRDY_STATU S	HH_STATUS	HL_STATUS	TH_STATUS	TL_STATUS	RES	RES	RES

Table 16. Address 0x04 Humidity MSB Field Descriptions

BIT	FIELD	TYPE	RESET	DESCRIPTION
7	DRDY_STATUS	R/W	0	DataReady bit status 0 = Data Not Ready 1 = Data Ready DRDY_STATU S is cleared to 0 when read
6	HH_STATUS	R/W	0	Temperature threshold HIGH Interrupt status 0 = No interrupt 1 = Interrupt TH_STATUS is cleared to 0 when read
5	HL_STATUS	R/W	0	Temperature threshold LOW Interrupt status 0 = No interrupt 1 = Interrupt TL_STATUS is cleared to 0 when read
4	TH_STATUS	R/W	0	Humidity threshold HIGH Interrupt status 0 = No interrupt 1 = Interrupt HH_STATUS is cleared to 0 when read
3	TL_STATUS	R/W	0	Humidity threshold LOW Interrupt status 0 = No interrupt 1 = Interrupt HL_STATUS is cleared to 0 when read
2	RES		0	Reserved
1	RES		0	Reserved
0	RES		0	Reserved

DRDY_STATUS indicates that temperature and/or humidity conversion is terminated. This bit is cleared when the Interrupt/DRDY register is read or the output registers TEMPERATURE_HIGH, TEMPERATURE_LOW, HUMIDITY_HIGH and HUMIDITY_LOW are read.

The TL_STATUS indicates that the *Temperature Threshold LOW* value is exceeded. The behavior is defined by 0x0E Configuration register value. The bit is cleared when the register Interrupt DRDY is read.

The TH_STATUS indicates that the *Temperature Threshold HIGH* value is exceeded. The behavior is defined by 0x0E Configuration register value. The bit is cleared when the register Interrupt DRDY is read.

The HH_STATUS indicates that the *Humidity Threshold HIGH* value is exceeded. The behavior is defined by 0x0E Configuration register value. The bit is cleared when the register Interrupt DRDY is read.

The HL_STATUS indicates that the *Humidity Threshold LOW* value is exceeded. The behavior is defined by 0x0E Configuration register value. The bit is cleared when the register Interrupt DRDY is read.

DRDY/INT pin behaves like the STATUS bits based on the 0x0E Configuration register value.

7.6.6 Address 0x05 Temperature MAX

Table 17. Address 0x05 Temperature MAX Register

7	6	5	4	3	2	1	0
TEMPERATUREMAX[7:0]							

Table 18. Address 0x05 Temperature Max Field Descriptions

BIT	FIELD	TYPE	RESET	DESCRIPTION
[7:0]	TEMPERATUREMAX[7:0]	R/W	00000000	Temperature max value measured (peak detection) Write 0x00 to erase the last value

The temperature can be calculated from the output data with:

$$\text{Temperature (}^{\circ}\text{C)} = \left(\frac{\text{TEMPERATUREMAX}[7:0]}{2^8} \right) \times 165 - 40$$

(3)

This register implements temperature peak detector function. It stores the highest temperature value converted after the power up. Value is reset at power up and/or with soft reset procedure.

7.6.7 Address 0x06 Humidity MAX

Table 19. Address 0x06 Humidity MAX Register

7	6	5	4	3	2	1	0
HUMIDITYMAX[7:0]							

Table 20. Address 0x06 Humidity MAX Field Descriptions

BIT	FIELD	TYPE	RESET	DESCRIPTION
[7:0]	HUMIDITYMAX[7:0]	R/W	00000000	Humidity max value measured (peak detection) Write 0x00 to erase the last value

The humidity can be calculated from the output data with:

$$\text{Humidity (\%RH)} = \text{HUMIDITYMAX}[7:0] \times \left(\frac{100}{2^8} \right)$$

(4)

This register implements humidity peak detector function. It stores the highest humidity value converted after the power up. Value is reset at power up and/or with soft reset procedure.

7.6.8 Address 0x07 Interrupt Configuration

Table 21. Address 0x07 Interrupt Configuration Register

7	6	5	4	3	2	1	0
DRDY_MASK	TH_MASK	TL_MASK	HH_MASK	HL_MASK	RES	RES	RES

Table 22. Address 0x07 Humidity MSB Field Descriptions

BIT	FIELD	TYPE	RESET	DESCRIPTION
7	DRDY_MASK	R/W	0	DataReady Interrupt mask 0 = DataReady Interrupt generator disable 1 = DataReady Interrupt generator enable
6	TH_MASK	R/W	0	Temperature threshold HIGH Interrupt mask 0 = Temperature high Interrupt generator enable 1 = Temperature high Interrupt generator disable
5	TL_MASK	R/W	0	Temperature threshold LOW Interrupt mask 0 = Temperature low Interrupt generator enable 1 = Temperature low Interrupt generator disable
4	HH_MASK	R/W	0	Humidity threshold HIGH Interrupt mask 0 = Humidity high Interrupt generator enable 1 = Humidity high Interrupt generator disable
3	HL_MASK	R/W	0	Humidity threshold LOW Interrupt mask 0 = Humidity low Interrupt generator enable 1 = Humidity Low Interrupt generator disable
2	RES		0	Reserved
1	RES		0	Reserved
0	RES		0	Reserved

7.6.9 Address 0x08 Temperature Offset Adjustment

Table 23. Address 0x08 Temperature Offset Adjustment Register

7	6	5	4	3	2	1	0
TEMP_OFFSET_ADJUST[7:0]							

Table 24. Address 0x08 Temperature Offset Adjustment Field Descriptions

BIT	FIELD	TYPE	RESET	DESCRIPTION
[7:0]	TEMP_OFFSET_ADJUST [7:0]	R/W	00000000	Temperature offset adjustment. Added to the converted Temperature value

The temperature can be adjusted adding the following values that are enable settings the equivalents bits:

7	6	5	4	3	2	1	0
-20.62	10.32	5.16	2.58	1.28	0.64	0.32	0.16

The value is added to the converted temperature value for offset adjustment.

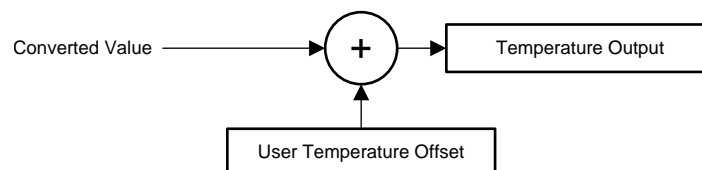

Figure 14. Temperature Offset

7.6.10 Address 0x09 Humidity Offset Adjustment

Table 25. Address 0x09 Humidity Offset Adjustment Register

7	6	5	4	3	2	1	0
HUM_OFFSET_ADJUST [7:0]							

Table 26. Address 0x09 Humidity Offset Adjustment Field Descriptions

BIT	FIELD	TYPE	RESET	DESCRIPTION
[7:0]	HUM_OFFSET_ADJUST [7:0]	R/W	00000000	Humidity offset adjustment. Added to the converted Humidity value

The humidity can be adjusted adding the following values that are enable settings the equivalent bits:

7	6	5	4	3	2	1	0
-25	12.5	6.3	3.1	1.6	0.8	0.4	0.2

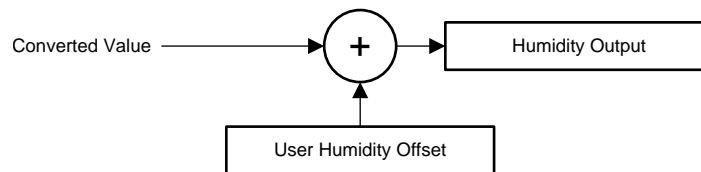

Figure 15. Humidity Offset

7.6.11 Address 0x0A Temperature Threshold HIGH

Table 27. Address 0x0A Temperature Threshold HIGH Register

7	6	5	4	3	2	1	0
TEMP_THRES_HIGH[7:0]							

Table 28. Address 0x0A Temperature Threshold HIGH Field Descriptions

BIT	FIELD	TYPE	RESET	DESCRIPTION
[7:0]	TEMP_THRES_HIGH[7:0]	R/W	11111111	Temperature threshold HIGH value

$$\text{Temperature threshold high (}^\circ\text{C)} = \left(\frac{\text{TEMP_THRES_HIGH [7 : 0]}}{2^8} \right) \times 165 - 40 \quad (5)$$

7.6.12 Address 0x0B Temperature Threshold LOW

Table 29. Address 0x0B Temperature Threshold LOW Register

7	6	5	4	3	2	1	0
TEMP_THRES_LOW[7:0]							

Table 30. Address 0x0B Temperature Threshold LOW Field Descriptions

BIT	FIELD	TYPE	RESET	DESCRIPTION
[7:0]	TEMP_THRES_LOW[7:0]	R/W	00000000	Temperature threshold LOW value

$$\text{Temperature threshold low (}^\circ\text{C)} = \left(\frac{\text{TEMP_THRES_LOW [7 : 0]}}{2^8} \right) \times 165 - 40 \quad (6)$$

7.6.13 Address 0x0C Humidity Threshold HIGH
Table 31. Address 0x0C Humidity Threshold HIGH Register

7	6	5	4	3	2	1	0
HUMI_THRES_HIGH[7:0]							

Table 32. Address 0x0C Humidity Threshold HIGH Field Descriptions

BIT	FIELD	TYPE	RESET	DESCRIPTION
[7:0]	HUMI_THRES_HIGH[7:0]	R/W	11111111	Humidity threshold HIGH value

$$\text{Humidity threshold high (\%RH)} = \left(\frac{\text{HUMI_THRES_HIGH [7 : 0]}}{2^8} \right) \times 100 \quad (7)$$

7.6.14 Address 0x0D Humidity Threshold LOW
Table 33. Address 0x0D Humidity Threshold LOW Register

7	6	5	4	3	2	1	0
HUMI_THRES_LOW[7:0]							

Table 34. Address 0x0D Humidity Threshold LOW Field Descriptions

BIT	FIELD	TYPE	RESET	DESCRIPTION
[7:0]	HUMI_THRES_LOW[7:0]	R/W	00000000	Humidity threshold LOW value

$$\text{Humidity threshold low (°C)} = \left(\frac{\text{HUMI_THRES_LOW [7 : 0]}}{2^8} \right) \times 100 \quad (8)$$

7.6.15 Address 0x0E Reset and DRDY/INT Configuration Register
Table 35. Address 0x0E Reset and DRDY/INT Configuration Register

7	6	5	4	3	2	1	0
SOFT_RES	ODR[2]	ODR[1]	ODR[0]	HEAT_EN	DRDY/INT_EN	INT_POL	INT_MODE

Table 36. Address 0x0E Reset and DRDY/INT Configuration Field Descriptions

BIT	FIELD	TYPE	RESET	DESCRIPTION
7	SOFT_RES	R/W	0	0 = Normal Operation mode, this bit is self-clear 1 = Soft Reset EEPROM value reload and registers reset
[6:4]	ODR[2:0]	R/W	000	Output Data Rate 000 = No repeated measurements. Trigger on demand 001 = 1/120Hz (1 samples every 2 minutes) 010 = 1/60Hz (1 samples every minute) 011 = 0.1Hz (1 samples every 10 seconds) 100 = 0.2 Hz (1 samples every 5 second) 101 = 1Hz (1 samples every second) 110 = 2Hz (2 samples every second) 111 = 5Hz (5 samples every second)
3	HEAT_EN	R/W	0	0 = Heater off 1 = Heater on
2	DRDY/INT_EN	R/W	0	DRDY/INT_EN pin configuration 0 = High Z 1 = Enable
1	INT_POL	R/W	0	Interrupt polarity 0 = Active Low 1 = Active High
0	INT_MODE		0	Interrupt mode 0 = Level sensitive 1 = Comparator mode

7.6.16 Address 0x0F Measurement Configuration
Table 37. Address 0x0F Measurement Configuration Register

7	6	5	4	3	2	1	0
TRES[1]	TRES[0]	HRES[1]	HRES[0]	RES	MEAS_CONF[1]	MEAS_CONF[0]	MEAS_TRIG

Table 38. Address 0x0F Measurement Configuration Field Descriptions

BIT	FIELD	TYPE	RESET	DESCRIPTION
7:6	TRES[1:0]	R/W	00	Temperature resolution 00: 14 bit 01: 11 bit 10: 9 bit 11: NA (TBC)
5:4	HRES[1:0]	R/W	00	Humidity resolution 00: 14 bit 01: 11 bit 10: 9 bit 11: NA (TBC)
3	RES	R/W	0	Reserved
2:1	MEAS_CONF[1:0]	R/W	00	Measurement configuration 00: Humidity + Temperature 01: Temperature only 10: Humidity Only 11: NA
0	MEAS_TRIG	R/W	0	Measurement trigger 0: no action 1: Start measurement Self-cleaning bit when measurement completed

7.6.17 Manufacturer ID Low

Table 39. Manufacturer ID Low Register

7	6	5	4	3	2	1	0
MANUFACTURER ID[7:0]							

Table 40. Address 0xFC Manufacturer ID Low Field Descriptions

BIT	FIELD	TYPE	RESET	DESCRIPTION
[7:0]	MANUFACTURER ID [7:0]	R	01001001	Manufacturer ID LOW value

7.6.18 Manufacturer ID High

These registers contain a factory-programmable identification value that identifies this device as being manufactured by Texas Instruments. These registers distinguish this device from other devices that are on the same I²C bus. The manufacturer ID reads 0x5449

Table 41. Manufacturer ID High Register

7	6	5	4	3	2	1	0
MANUFACTURER ID[15:8]							

Table 42. Address 0xFD Manufacturer ID High Field Descriptions

BIT	FIELD	TYPE	RESET	DESCRIPTION
[7:0]	MANUFACTURER ID [15:8]	R	01010100	Manufacturer ID HIGH value

7.6.19 Device ID Low

Table 43. Device ID Low Register

7	6	5	4	3	2	1	0
DEVICE ID[7:0]							

Table 44. Address 0xFE Device ID Low Field Descriptions

BIT	FIELD	TYPE	RESET	DESCRIPTION
[7:0]	DEVICE ID [7:0]	R	11010000	Device ID LOW value

7.6.20 Device ID High

These registers contain a factory-programmable identification value that identifies this device as a HDC2010. These registers distinguish this device from other devices that are on the same I²C bus. The Device ID for the HDC2010 is 0x07D0

Table 45. Device ID High Register

7	6	5	4	3	2	1	0
DEVICE ID[15:8]							

Table 46. Address 0xFF Device ID High Field Descriptions

BIT	FIELD	TYPE	RESET	DESCRIPTION
[7:0]	DEVICE ID [15:8]	R	00000111	Device ID HIGH value

8 Application and Implementation

NOTE

Information in the following applications sections is not part of the TI component specification, and TI does not warrant its accuracy or completeness. TI's customers are responsible for determining suitability of components for their purposes. Customers should validate and test their design implementation to confirm system functionality.

8.1 Application Information

An HVAC system thermostat control is based on environmental sensors and a micro-controller. The microcontroller acquires data from humidity sensors and temperature sensors and controls the heating/cooling system. The collected data are then shown on a display that can be easily controlled by the micro controller. Based on data from the humidity and temperature sensor, the heating/cooling system then maintains the environment at customer-defined preferred conditions.

8.2 Typical Application

In a battery-powered HVAC system thermostat, one of the key parameters in the selection of components is the power consumption. The HDC2010, with 550nA of current consumption (average consumption over 1s for RH and Temperature measurements), in conjunction with an MSP430, represents an excellent choice for low power consumption, which extends the battery life. A system block diagram of a battery powered thermostat is shown in [Figure 16](#)

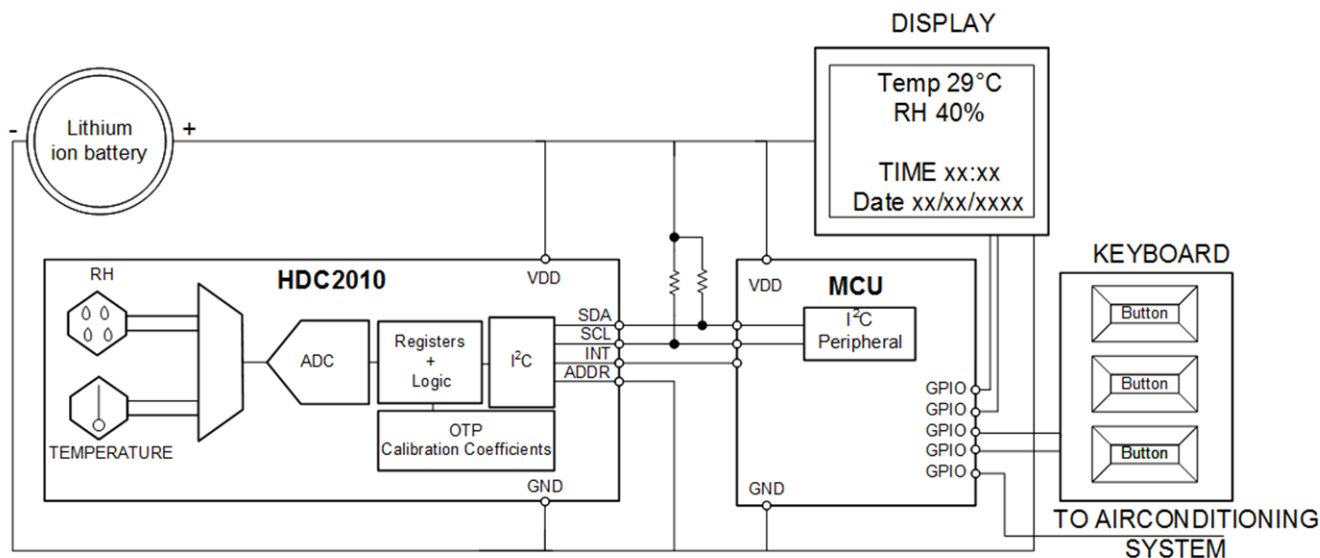

Copyright © 2017, Texas Instruments Incorporated

Figure 16. Typical Application Schematic HVAC

8.2.1 Design Requirements

In order to correctly sense the ambient temperature and humidity, the HDC2010 must be positioned away from heat sources on the PCB. It must not be close to the LCD and battery. Moreover, to minimize any self-heating of the HDC2010 it is recommended to acquire at a maximum sample rate of 1sps (RH + Temp). In home systems, humidity and the temperature monitoring rates of less than 1sps (even 0.5sps or 0.2sps) can be still effective.

Typical Application (continued)

8.2.2 Detailed Design Procedure

When a circuit board layout is created from the schematic shown in [Figure 16](#) a small circuit board is possible. The accuracy of a RH and temperature measurement depends on the sensor accuracy and the setup of the sensing system. The HDC2010 samples relative humidity and temperature in its immediate environment, it is therefore important that the local conditions at the sensor match the monitored environment. Use one or more openings in the physical cover of the thermostat to obtain a good airflow even in static conditions. Refer to the layout ([Figure 19](#)) for a PCB layout which minimizes the thermal mass of the PCB in the region of the HDC2010, which can improve measurement response time and accuracy.

8.2.3 Application Curves

The data shown was acquired with the HDC2010EVM. A humidity chamber was used to control the environment.

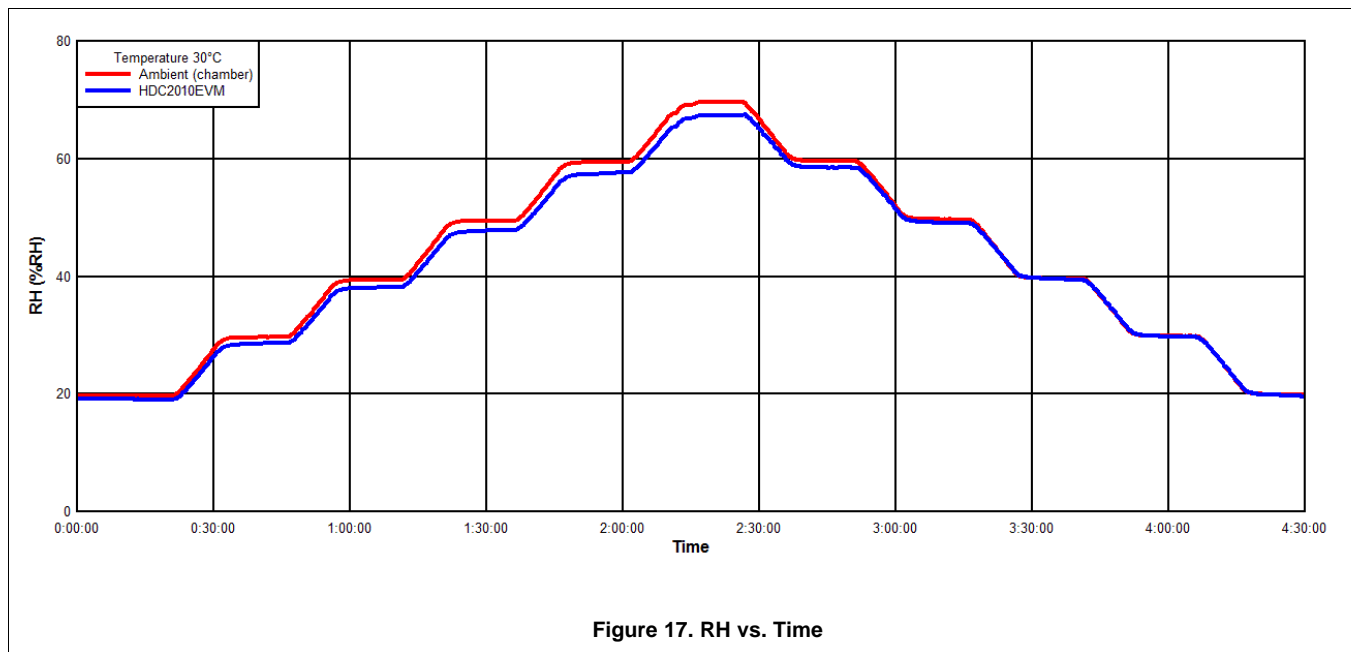

8.3 Do's and Don'ts

8.3.1 Soldering

For soldering HDC2010, standard reflow soldering ovens may be used. The sensor is qualified to withstand soldering profile according to IPC/JEDEC J-STD-020 with peak temperatures at 260 °C. Refer to the document [SNVA009](#) for more details on the DSBGA package. In the document refer to DSBGA package with bump size 0.5mm pitch and 0.32mm diameter.

Only no clean solder paste may be used when soldering the HDC2010 and no liquid based cleaning or board wash can be used. The HDC2010 must be limited to a single IR reflow and no rework is recommended.

Immediately after solder reflow the sensor will generally output a shifted relative humidity. This RH shift will disappear over time as the sensor is exposed to typical indoor ambient conditions (room temperature, 30-55%RH). After 1-3 days at ambient conditions the device will return to the specified RH accuracy.

Do's and Don'ts (continued)

8.3.2 Ambient Exposure, Storage and Handling

The HDC2010 has an exposed humidity sensor which needs to be handled with more care than standard semiconductor circuit components. Long exposures to UV light, visible light or high concentration chemical vapors for prolonged periods may shift the RH output and should be avoided. Exposure to high concentrations of out-gassed solvent vapors for long times should be avoided during manufacturing, transport and operation. Package materials which can produce significant out-gassing include: some adhesives (tapes or dispensed), ESD foils, ESD foams, etc.

8.3.3 High Temperature and Humidity Exposure

Long exposure outside the recommended operating conditions may temporarily offset the RH output. [Table 47](#) shows the RH offset values that can be expected for exposure to 85 °C and 85 % RH for durations between 12 and 500 hours (continuous).

Table 47. Induced RH Offset Due to Extended Exposure to High Humidity and High Temperature (85°C/85% RH)

85°C/85% RH Duration (hours)	12	24	168	500
RH Offset (%)	3	6	12	15

When the sensor is exposed to less severe conditions, [Figure 18](#) shows the typical RH offset at other combinations of temperature and RH.

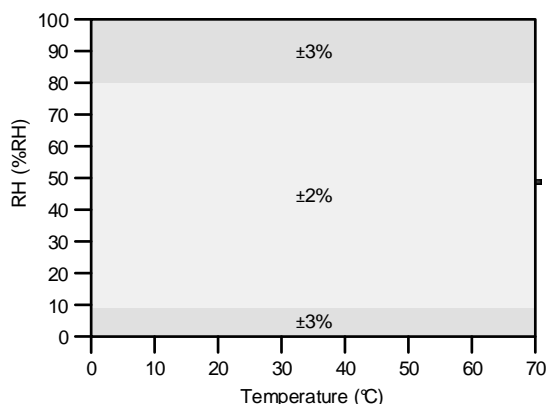

Figure 18. Relative Humidity Accuracy vs Temperature

9 Power Supply Recommendations

The HDC2010 requires a voltage supply within 1.62 V and 3.6 V. TI recommends a multilayer ceramic bypass X7R capacitor of 0.1µF between the VDD and GND pins.

9.1 Average Current Consumption Calculation

HDC2010 average current consumption is function of selected parameters:

- Resolution;
- Output data rate;

Average current consumption takes in account the following specifications:

- Current consumption during conversion;
- Data conversion duration (RH_{CT} and $TEMP_{CT}$);
- Current consumption in stand-by ($I_{DD-SLEEP}$)

Average current calculation

Average current = $\{[(H_Conv_Time * H_Conv_Cur) + (T_Conv_Time * T_Conve_Corr)] + [(ODR - (T_Conv_Time + T_Conve_Corr)) * Sleep]\} / ODR$

Example:

- Resolution = 11bit for both Humidity and Temperature
- Output Data Rate: ODR = 1Hz (1sec = 1000000us)
- Humidity conversion time: H_Conv_Time = 400us (for 11 bit resolution)
- Temperature conversion time: T_Conv_Time = 350 us (for 11 bit resolution)
- Humidity conversion current consumption: H_Conv_Cur = 650uA
- Temperature conversion current consumption: T_Conve_Corr = 550uA
- Sleep current: Sleep = 0.05uA

Average current = $\{[(400us * 650uA) + (350us * 550uA)] + [(1000000us - (400us + 350us)) * 0.05uA]\} / 1000000us = 0.502uA$

10 Layout

10.1 Layout Guidelines

The Relative Humidity sensor element is located on the top side of the package.

It is recommended to isolate the sensor from the rest of the PCB by eliminating copper layers below the device (GND, V_{DD}) and creating a slot into the PCB around the sensor to enhance thermal isolation.

10.2 Layout Example

The only component next to the device is the supply bypass capacitor. Since the relative humidity is dependent on the temperature, the HDC2010 must be positioned away from hot spots present on the board, such as a battery, display or micro-controller. Slots around the device can be used to reduce the thermal mass, for a quicker response for environmental changes.

Layout Example (continued)

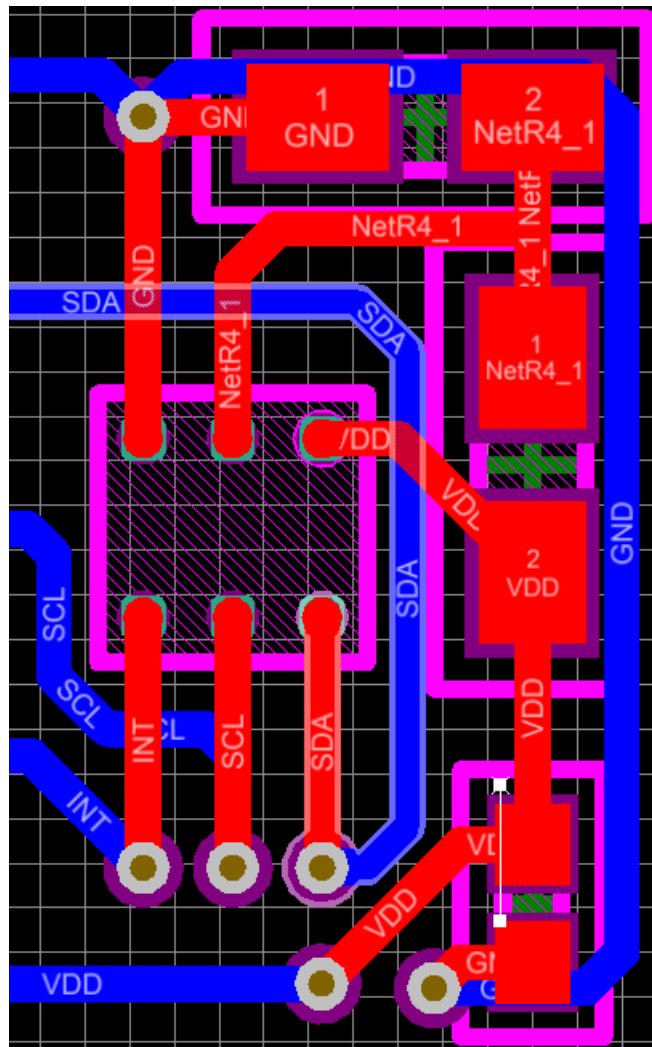

Figure 19. Layout

11 Device and Documentation Support

11.1 Documentation Support

11.1.1 Related Documentation

For related documentation see the following:

[HDC2010EVM User's Guide](#)

11.2 Receiving Notification of Documentation Updates

To receive notification of documentation updates, navigate to the device product folder on ti.com. In the upper right corner, click on *Alert me* to register and receive a weekly digest of any product information that has changed. For change details, review the revision history included in any revised document.

11.3 Community Resources

The following links connect to TI community resources. Linked contents are provided "AS IS" by the respective contributors. They do not constitute TI specifications and do not necessarily reflect TI's views; see TI's [Terms of Use](#).

TI E2E™ Online Community *TI's Engineer-to-Engineer (E2E) Community*. Created to foster collaboration among engineers. At e2e.ti.com, you can ask questions, share knowledge, explore ideas and help solve problems with fellow engineers.

Design Support *TI's Design Support* Quickly find helpful E2E forums along with design support tools and contact information for technical support.

11.4 Trademarks

E2E is a trademark of Texas Instruments.

All other trademarks are the property of their respective owners.

11.5 Electrostatic Discharge Caution



This integrated circuit can be damaged by ESD. Texas Instruments recommends that all integrated circuits be handled with appropriate precautions. Failure to observe proper handling and installation procedures can cause damage.

ESD damage can range from subtle performance degradation to complete device failure. Precision integrated circuits may be more susceptible to damage because very small parametric changes could cause the device not to meet its published specifications.

11.6 Glossary

[SLYZ022](#) — *TI Glossary*.

This glossary lists and explains terms, acronyms, and definitions.

12 Mechanical, Packaging, and Orderable Information

The following pages include mechanical, packaging, and orderable information. This information is the most current data available for the designated devices. This data is subject to change without notice and revision of this document. For browser-based versions of this data sheet, refer to the left-hand navigation.

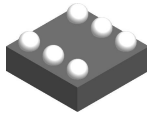

YPA0006

PACKAGE OUTLINE

DSBGA - 0.675 mm max height

DIE SIZE BALL GRID ARRAY

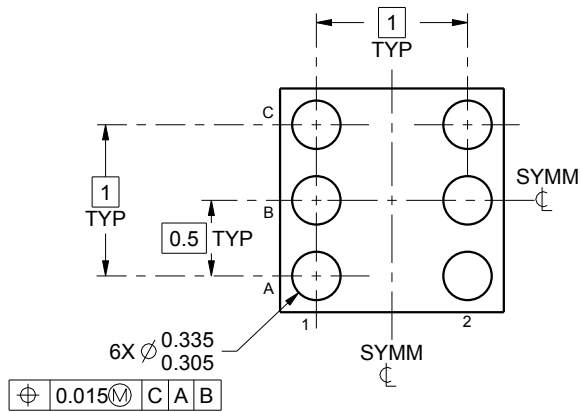
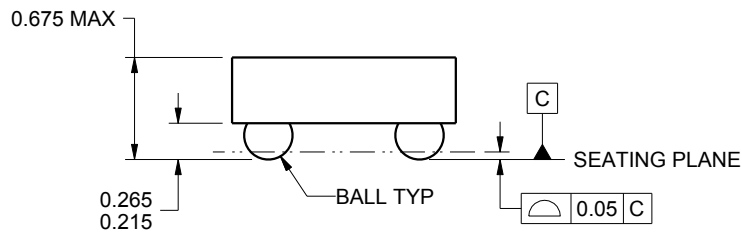
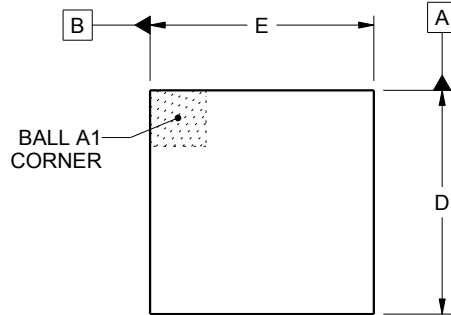

4223083/A 06/2016

NOTES:

1. All linear dimensions are in millimeters. Any dimensions in parenthesis are for reference only. Dimensioning and tolerancing per ASME Y14.5M.
2. This drawing is subject to change without notice.

EXAMPLE BOARD LAYOUT

YPA0006

DSBGA - 0.675 mm max height

DIE SIZE BALL GRID ARRAY

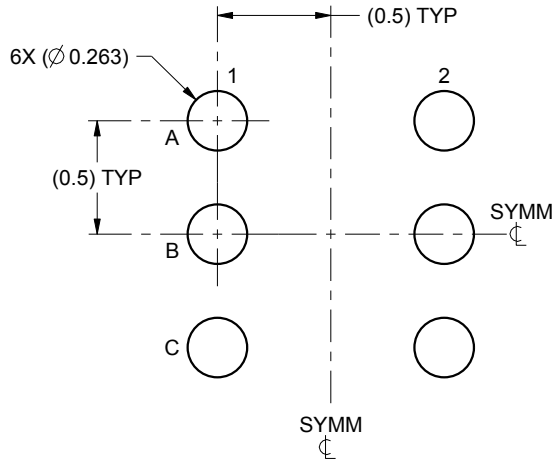

LAND PATTERN EXAMPLE
SCALE:30X

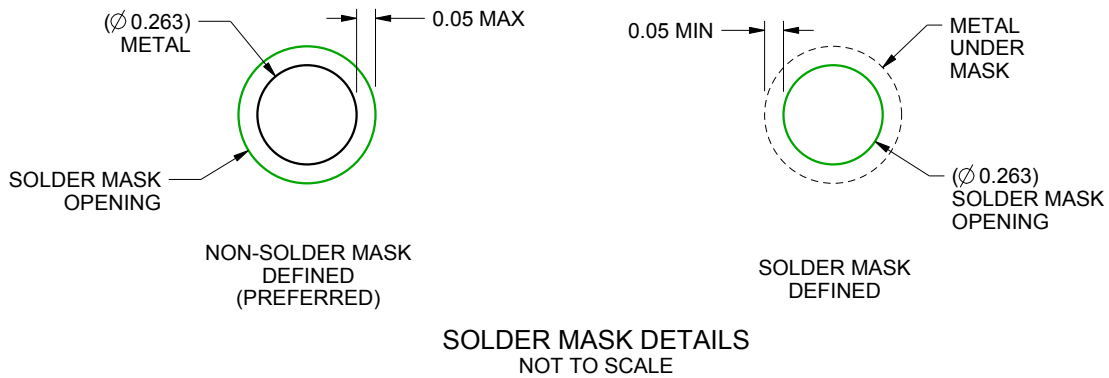

4223083/A 06/2016

NOTES: (continued)

- Final dimensions may vary due to manufacturing tolerance considerations and also routing constraints. See Texas Instruments Literature No. SNVA009 (www.ti.com/lit/snva009).

EXAMPLE STENCIL DESIGN

YPA0006

DSBGA - 0.675 mm max height

DIE SIZE BALL GRID ARRAY

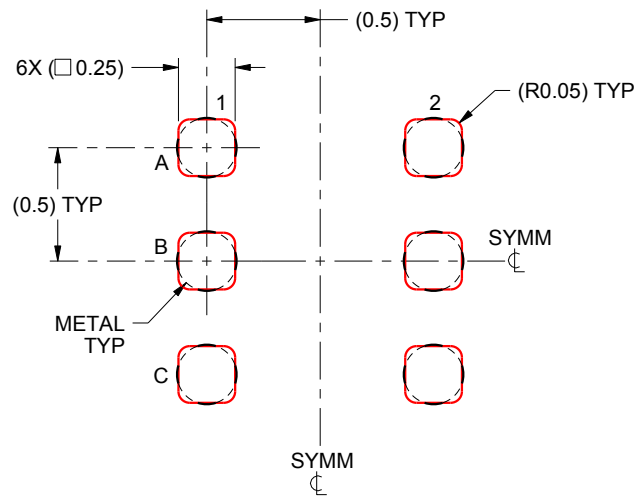

SOLDER PASTE EXAMPLE
BASED ON 0.1mm THICK STENCIL
SCALE:30X

4223083/A 06/2016

NOTES: (continued)

4. Laser cutting apertures with trapezoidal walls and rounded corners may offer better paste release.

PACKAGING INFORMATION

Orderable Device	Status (1)	Package Type	Package Drawing	Pins	Package Qty	Eco Plan (2)	Lead/Ball Finish (6)	MSL Peak Temp (3)	Op Temp (°C)	Device Marking (4/5)	Samples
HDC2010YPAR	ACTIVE	DSBGA	YPA	6	3000	Green (RoHS & no Sb/Br)	SAC405 SNAGCU	Level-1-260C-UNLIM	-40 to 85	L	Samples
HDC2010YPAT	ACTIVE	DSBGA	YPA	6	250	Green (RoHS & no Sb/Br)	SAC405 SNAGCU	Level-1-260C-UNLIM	-40 to 85	L	Samples

(1) The marketing status values are defined as follows:

ACTIVE: Product device recommended for new designs.

LIFEBUY: TI has announced that the device will be discontinued, and a lifetime-buy period is in effect.

NRND: Not recommended for new designs. Device is in production to support existing customers, but TI does not recommend using this part in a new design.

PREVIEW: Device has been announced but is not in production. Samples may or may not be available.

OBSOLETE: TI has discontinued the production of the device.

(2) **RoHS:** TI defines "RoHS" to mean semiconductor products that are compliant with the current EU RoHS requirements for all 10 RoHS substances, including the requirement that RoHS substance do not exceed 0.1% by weight in homogeneous materials. Where designed to be soldered at high temperatures, "RoHS" products are suitable for use in specified lead-free processes. TI may reference these types of products as "Pb-Free".

RoHS Exempt: TI defines "RoHS Exempt" to mean products that contain lead but are compliant with EU RoHS pursuant to a specific EU RoHS exemption.

Green: TI defines "Green" to mean the content of Chlorine (Cl) and Bromine (Br) based flame retardants meet JS709B low halogen requirements of <=1000ppm threshold. Antimony trioxide based flame retardants must also meet the <=1000ppm threshold requirement.

(3) MSL, Peak Temp. - The Moisture Sensitivity Level rating according to the JEDEC industry standard classifications, and peak solder temperature.

(4) There may be additional marking, which relates to the logo, the lot trace code information, or the environmental category on the device.

(5) Multiple Device Markings will be inside parentheses. Only one Device Marking contained in parentheses and separated by a "-" will appear on a device. If a line is indented then it is a continuation of the previous line and the two combined represent the entire Device Marking for that device.

(6) Lead/Ball Finish - Orderable Devices may have multiple material finish options. Finish options are separated by a vertical ruled line. Lead/Ball Finish values may wrap to two lines if the finish value exceeds the maximum column width.

Important Information and Disclaimer:The information provided on this page represents TI's knowledge and belief as of the date that it is provided. TI bases its knowledge and belief on information provided by third parties, and makes no representation or warranty as to the accuracy of such information. Efforts are underway to better integrate information from third parties. TI has taken and continues to take reasonable steps to provide representative and accurate information but may not have conducted destructive testing or chemical analysis on incoming materials and chemicals. TI and TI suppliers consider certain information to be proprietary, and thus CAS numbers and other limited information may not be available for release.

In no event shall TI's liability arising out of such information exceed the total purchase price of the TI part(s) at issue in this document sold by TI to Customer on an annual basis.

TAPE AND REEL INFORMATION



QUADRANT ASSIGNMENTS FOR PIN 1 ORIENTATION IN TAPE



*All dimensions are nominal

Device	Package Type	Package Drawing	Pins	SPQ	Reel Diameter (mm)	Reel Width W1 (mm)	A0 (mm)	B0 (mm)	K0 (mm)	P1 (mm)	W (mm)	Pin1 Quadrant
HDC2010YPAR	DSBGA	YPA	6	3000	178.0	8.4	1.57	1.57	0.76	4.0	8.0	Q1
HDC2010YPAT	DSBGA	YPA	6	250	178.0	8.4	1.57	1.57	0.76	4.0	8.0	Q1

TAPE AND REEL BOX DIMENSIONS

*All dimensions are nominal

Device	Package Type	Package Drawing	Pins	SPQ	Length (mm)	Width (mm)	Height (mm)
HDC2010YPAR	DSBGA	YPA	6	3000	210.0	185.0	35.0
HDC2010YPAT	DSBGA	YPA	6	250	210.0	185.0	35.0

IMPORTANT NOTICE

Texas Instruments Incorporated (TI) reserves the right to make corrections, enhancements, improvements and other changes to its semiconductor products and services per JESD46, latest issue, and to discontinue any product or service per JESD48, latest issue. Buyers should obtain the latest relevant information before placing orders and should verify that such information is current and complete.

TI's published terms of sale for semiconductor products (<http://www.ti.com/sc/docs/stdterms.htm>) apply to the sale of packaged integrated circuit products that TI has qualified and released to market. Additional terms may apply to the use or sale of other types of TI products and services.

Reproduction of significant portions of TI information in TI data sheets is permissible only if reproduction is without alteration and is accompanied by all associated warranties, conditions, limitations, and notices. TI is not responsible or liable for such reproduced documentation. Information of third parties may be subject to additional restrictions. Resale of TI products or services with statements different from or beyond the parameters stated by TI for that product or service voids all express and any implied warranties for the associated TI product or service and is an unfair and deceptive business practice. TI is not responsible or liable for any such statements.

Buyers and others who are developing systems that incorporate TI products (collectively, "Designers") understand and agree that Designers remain responsible for using their independent analysis, evaluation and judgment in designing their applications and that Designers have full and exclusive responsibility to assure the safety of Designers' applications and compliance of their applications (and of all TI products used in or for Designers' applications) with all applicable regulations, laws and other applicable requirements. Designer represents that, with respect to their applications, Designer has all the necessary expertise to create and implement safeguards that (1) anticipate dangerous consequences of failures, (2) monitor failures and their consequences, and (3) lessen the likelihood of failures that might cause harm and take appropriate actions. Designer agrees that prior to using or distributing any applications that include TI products, Designer will thoroughly test such applications and the functionality of such TI products as used in such applications.

TI's provision of technical, application or other design advice, quality characterization, reliability data or other services or information, including, but not limited to, reference designs and materials relating to evaluation modules, (collectively, "TI Resources") are intended to assist designers who are developing applications that incorporate TI products; by downloading, accessing or using TI Resources in any way, Designer (individually or, if Designer is acting on behalf of a company, Designer's company) agrees to use any particular TI Resource solely for this purpose and subject to the terms of this Notice.

TI's provision of TI Resources does not expand or otherwise alter TI's applicable published warranties or warranty disclaimers for TI products, and no additional obligations or liabilities arise from TI providing such TI Resources. TI reserves the right to make corrections, enhancements, improvements and other changes to its TI Resources. TI has not conducted any testing other than that specifically described in the published documentation for a particular TI Resource.

Designer is authorized to use, copy and modify any individual TI Resource only in connection with the development of applications that include the TI product(s) identified in such TI Resource. NO OTHER LICENSE, EXPRESS OR IMPLIED, BY ESTOPPEL OR OTHERWISE TO ANY OTHER TI INTELLECTUAL PROPERTY RIGHT, AND NO LICENSE TO ANY TECHNOLOGY OR INTELLECTUAL PROPERTY RIGHT OF TI OR ANY THIRD PARTY IS GRANTED HEREIN, including but not limited to any patent right, copyright, mask work right, or other intellectual property right relating to any combination, machine, or process in which TI products or services are used. Information regarding or referencing third-party products or services does not constitute a license to use such products or services, or a warranty or endorsement thereof. Use of TI Resources may require a license from a third party under the patents or other intellectual property of the third party, or a license from TI under the patents or other intellectual property of TI.

TI RESOURCES ARE PROVIDED "AS IS" AND WITH ALL FAULTS. TI DISCLAIMS ALL OTHER WARRANTIES OR REPRESENTATIONS, EXPRESS OR IMPLIED, REGARDING RESOURCES OR USE THEREOF, INCLUDING BUT NOT LIMITED TO ACCURACY OR COMPLETENESS, TITLE, ANY EPIDEMIC FAILURE WARRANTY AND ANY IMPLIED WARRANTIES OF MERCHANTABILITY, FITNESS FOR A PARTICULAR PURPOSE, AND NON-INFRINGEMENT OF ANY THIRD PARTY INTELLECTUAL PROPERTY RIGHTS. TI SHALL NOT BE LIABLE FOR AND SHALL NOT DEFEND OR INDEMNIFY DESIGNER AGAINST ANY CLAIM, INCLUDING BUT NOT LIMITED TO ANY INFRINGEMENT CLAIM THAT RELATES TO OR IS BASED ON ANY COMBINATION OF PRODUCTS EVEN IF DESCRIBED IN TI RESOURCES OR OTHERWISE. IN NO EVENT SHALL TI BE LIABLE FOR ANY ACTUAL, DIRECT, SPECIAL, COLLATERAL, INDIRECT, PUNITIVE, INCIDENTAL, CONSEQUENTIAL OR EXEMPLARY DAMAGES IN CONNECTION WITH OR ARISING OUT OF TI RESOURCES OR USE THEREOF, AND REGARDLESS OF WHETHER TI HAS BEEN ADVISED OF THE POSSIBILITY OF SUCH DAMAGES.

Unless TI has explicitly designated an individual product as meeting the requirements of a particular industry standard (e.g., ISO/TS 16949 and ISO 26262), TI is not responsible for any failure to meet such industry standard requirements.

Where TI specifically promotes products as facilitating functional safety or as compliant with industry functional safety standards, such products are intended to help enable customers to design and create their own applications that meet applicable functional safety standards and requirements. Using products in an application does not by itself establish any safety features in the application. Designers must ensure compliance with safety-related requirements and standards applicable to their applications. Designer may not use any TI products in life-critical medical equipment unless authorized officers of the parties have executed a special contract specifically governing such use. Life-critical medical equipment is medical equipment where failure of such equipment would cause serious bodily injury or death (e.g., life support, pacemakers, defibrillators, heart pumps, neurostimulators, and implantables). Such equipment includes, without limitation, all medical devices identified by the U.S. Food and Drug Administration as Class III devices and equivalent classifications outside the U.S.

TI may expressly designate certain products as completing a particular qualification (e.g., Q100, Military Grade, or Enhanced Product). Designers agree that it has the necessary expertise to select the product with the appropriate qualification designation for their applications and that proper product selection is at Designers' own risk. Designers are solely responsible for compliance with all legal and regulatory requirements in connection with such selection.

Designer will fully indemnify TI and its representatives against any damages, costs, losses, and/or liabilities arising out of Designer's non-compliance with the terms and provisions of this Notice.