

THIS DRAWING IS UNPUBLISHED.

RELEASED FOR PUBLICATION

ALL RIGHTS RESERVED.

© COPYRIGHT - TE Connectivity Ltd.

REVISIONS

P	LTR	DESCRIPTION	DATE	DWN	APVD
	D	ECR-18-000229	10JAN2018	GCM	JL
	D1	ECR-19-008407	28MAY2019	RS	MZ

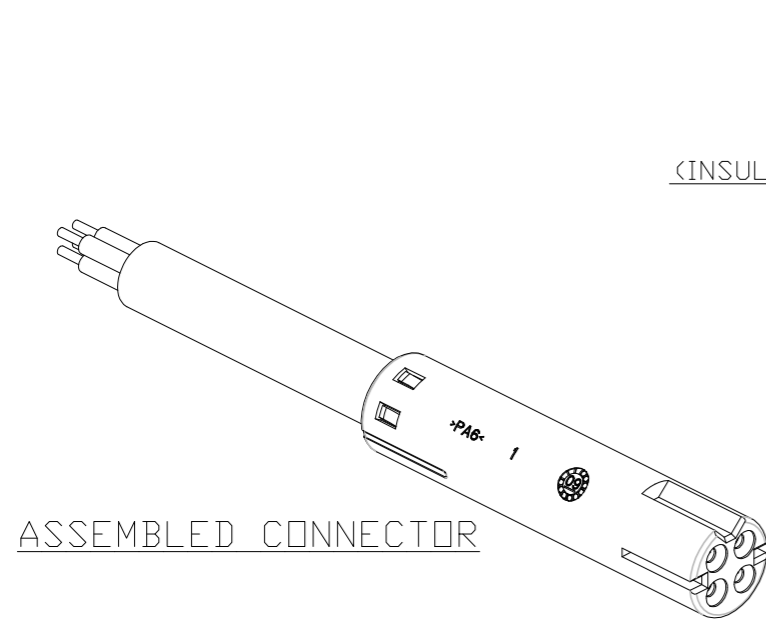

ASSEMBLED CONNECTOR

VOLTAGE: < 30V r.m.s. (42V PEAK)
MAXIMUM CURRENT: 2A PER WAY (FULL LOADED)

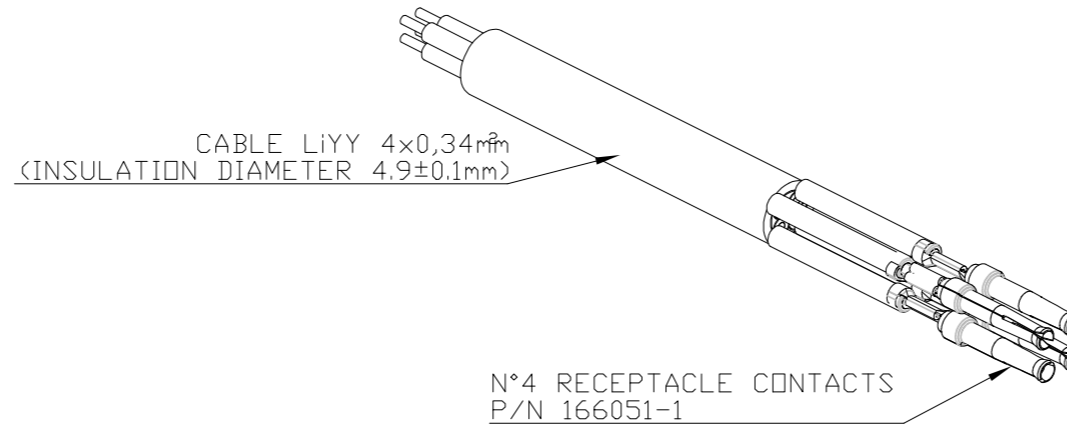

CABLE LIYY 4x0,34mm
(INSULATION DIAMETER 4.9±0.1mm)

N°4 RECEPTACLE CONTACTS
P/N 166051-1

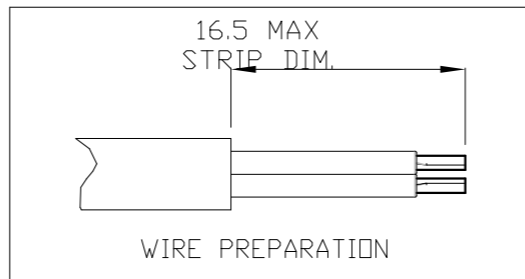

WIRE PREPARATION

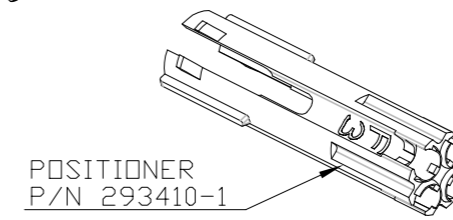

POSITIONER
P/N 293410-1

MOUNTING OVERVIEW

CONTACTS MUST BE MOUNTED ON THE POSITIONER BEFORE TO INSERT THEM INTO THE HOUSING. MOUNTING SHALL BE ACCORDING TO THE TYCO ELECTRONICS APPLICATION SPEC. 114-20147.

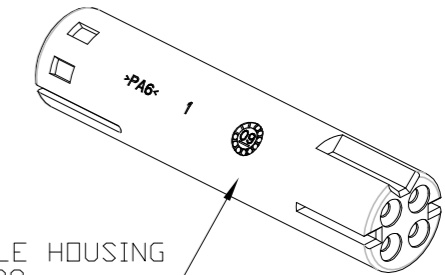

RECEPTACLE HOUSING
P/N 293408-...

RECEPTACLE HOUSING (N° 3 VERSIONS):
- P/N 293408-1 (REV. B) IN WHITE COLOUR
- P/N 293408-2 (REV. B) IN BLACK COLOUR
- P/N 293408-3 (REV. B) IN GRAY COLOUR

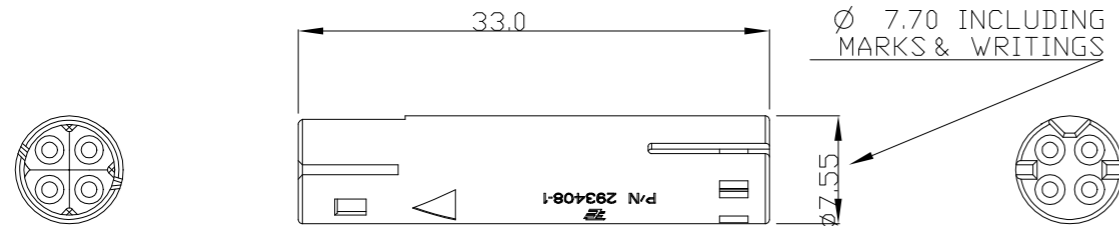

KEYING POLARIZATION FOR
P/N 293408-1 (WHITE VERSIONS)
AND FOR
P/N 293408-2 (BLACK VERSIONS)

KEYING POLARIZATION FOR
P/N 293408-3 (GRAY VERSIONS)

THE PRESENTED PRODUCT / DESIGN WILL BE RELEASED FOR THE MANUFACTURING OF THE NECESSARY PRODUCTION TOOLS HEREBY. FURTHER CHANGES HAS TO BE PAID BY CUSTOMER.
DATE, SIGN OF THE CUSTOMER

PACKAGING: N° 1500 PCS INTO CARTON BOX, ACCORDING TO PACKAGING SPEC. 107-20289.

OBSELETE	REC. HOUSING P/N	POSITIONER P/N	PART NUMBER (KIT)	REV.
	293408-3	293410-1	293411-3 (GRAY VERSION)	B
	293408-2	293410-1	293411-2 (BLACK VERSION)	B
	293408-1	293410-1	293411-1 (WHITE VERSION)	B

POSITIONER (N°1 VERSION):
- P/N 293410-1 (REV. B) IN BLACK COLOUR

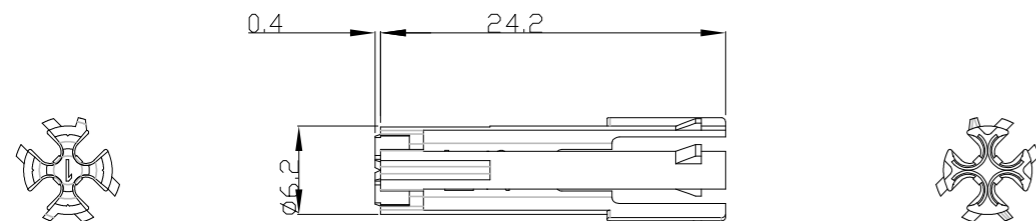

THIS DRAWING IS A CONTROLLED DOCUMENT.

DIMENSIONS:	TOLERANCES UNLESS OTHERWISE SPECIFIED:
mm	
0 PLC	± -
1 PLC	± -
2 PLC	± -
3 PLC	± -
4 PLC	± -
ANGLES	± -

MATERIAL: PLASTIC PARTS: PA ACC. TO GLOW WIRE 750°C NO FLAME
FINISH: -

DWN	12SEP2008
CHK	12SEP2008
APVD	12SEP2008
PRODUCT SPEC	108-20293
APPLICATION SPEC	114-20147
WEIGHT	0
CUSTOMER DRAWING	

TE Connectivity Ltd.

4 POS. LOW VOLTAGE
FREE HANGING, FEMALE CONNECTOR
FOR EUROPE MARKET

SIZE	CAGE CODE	DRAWING NO	RESTRICTED TO
A3	00779	C-293411	-
SCALE	1:1	SHEET	1 OF 1
			REV D1