

## Specification

Part No.	:	<b>MA850.A.LBICG.001</b>
Product Name	:	MA850 5in1 Permanent Mount Antenna LTE MIMO*2, Wi-Fi MIMO*2 & GPS/GLONASS/GALILEO/BeiDou
Features	:	2* LTE MIMO 698~960MHz/1710~2170MHz/2490~2690MHz 2* Wi-Fi MIMO 2.4GHz/5.8GHz 1* GPS-GLONASS-GALILEO-BeiDou Antenna Permanent Mount Worldwide 4G Bands including 3G and 2G IP69K Enclosure Dims: Diameter 94.3mm, Height 57.4mm 0.3M RG174 with SMA(M)/RP-SMA(M) as standard Custom Cables and Connectors Available <b>RoHS Compliant</b>



## 1. Introduction

The Colosseum MA850 5in1 antenna is a low profile, heavy-duty, fully IP69K waterproof external M2M antenna for use in worldwide telematics applications which require best in class LTE, Wi-Fi and GNSS performance. It is ideal for solutions that do not have space for mounting the larger Pantheon dome antennas but still require good efficiency and gain.

This unique product, at only 57.4mm tall, delivers powerful worldwide 4G LTE MIMO antenna technology at 700MHz/800MHz/1700MHz/1800MHz/2600MHz, dual-band Wi-Fi MIMO, plus GPS-GLONASS-GALILEO-BeiDou for next generation location accuracy. The LTE antenna also includes legacy 3G and 2G bands to enable fallback using the correct modems in areas where there is no 4G signal.

Typical Applications include:

- Bus Telematics
- Remote Asset and Pipeline Monitoring
- HD Video over LTE
- First Responder and Emergency Services
- Automotive Vehicle Tracking and Telematics

LTE 4G applications demand high speed data uplink and downlink. High efficiency and high gain MIMO antennas are necessary to achieve the required signal to noise ratio and throughput required to solve these challenges. Taoglas also takes care to have high isolation between the two MIMO antennas to prevent self-interference. Low loss cables are used to keep efficiency high over long cable lengths. In contrast, smaller MIMO antennas with poorer quality thinner cables will have much reduced efficiency and isolation, which would lead to a large drop in system throughput or drops, and may indeed not make a system connection at all.

The GPS-GLONASS-GALILEO-BeiDou active antenna has been carefully designed to work well on GPS, GLONASS, GALILEO and BeiDou L1 bands, leading to higher location accuracy and stability of tracking in urban environments.

Cable length and connector types are customizable. Contact your regional Taoglas sales office for support.

## 2. Specification (30\*30cm Ground Plane)

GPS-GLONASS-GALILEO-BeiDou				
Center Frequency	GPS/GALILEO: 1575.42±1.023MHz GLONASS: 1602±5MHz BeiDou: 1561.098±2.046MHz			
Passive Antenna Efficiency	GPS/GALILEO: 44% GLONASS: 58% BeiDou: 49%			
Passive Antenna Average Gain	GPS/GALILEO: -3.5dBi GLONASS: -2.4dBi BeiDou: -3.1dBi			
Passive Antenna Peak Gain	GPS/GALILEO: 2.3dBi GLONASS: 4.3dBi BeiDou: 3.3dBi			
VSWR	3:1 Max			
Impedance	50Ω			
Axial Ratio	GPS/GALILEO: <6.2 GLONASS: <9.8 BeiDou: <16.5			
Polarization	RHCP			
Cable	0.3 meter RG174 standard, fully customizable			
Connector	SMA(M), standard, fully customizable			
LNA and Filter Electrical Properties				
Center Frequency	GPS/GALILEO: 1575.42±1.023MHz GLONASS: 1602±5MHz BeiDou: 1561.098±2.046MHz			
Pout 1dB Gain Compression Point	-6dBm Min. -2 dBm Typ. (1561MHz, 1575.42MHz, 1602MHz)			
Output Impedance	50 Ohm			
VSWR	< 2:1			
Return Loss	10 dB Min.			
LNA Gain, Current Draw, and Noise Figure @GPS	Voltage	LNA Gain(Typ.)	Current Draw(Typ.)	Noise Figure(Typ.)
	Min 1.8V	28dB	7.9mA	1.9dB
	Typ. 3.0V	28dB	8.3mA	2.7dB
	Max 5.5V	30dB	8.3mA	2.2dB
Total specification (Through Antenna, SAW Filter, and LNA)				
Frequency	1561.068±2.046MHz	1575.42±1.023MHz	1602±5MHz	
Gain@3V	1575.42MHz: 31±3dBi	1575.42MHz: 31±3dBi	1602MHz: 31±3dBi	
Output Impedance	50Ω			

### 4G/3G/2G LTE Antenna

Frequency (MHz)	LTE700	LTE800	GSM850	GSM900	DCS	PCS	UMTS1	LTE2300	LTE2600	LTE3500
	698~803	703~803	824~894	880~960	1710 ~1880	1850 ~1990	1920 ~2170	2305 ~2360	2490 ~2690	3400 ~3600
Efficiency (%)										
MIMO_1	30cm	46.72		58.11	69.94	51.37	43.13	37.85		56.94
	1M	41.52		50.61	60.91	42.18	35.37	30.76		44.60
	2M	34.77		41.93	49.67	31.76	26.48	22.88		31.77
	3M	29.04		34.51	40.92	24.03	19.75	16.96		22.53
	5M	20.37		23.63	27.49	13.73	11.05	9.35		11.36
MIMO_2	30cm	56.05		58.56	55.08	53.24	48.41	43.71		55.22
	1M	49.82		51.01	47.98	43.71	39.67	35.53		43.25
	2M	41.75		42.30	39.13	32.91	29.72	26.44		30.80
	3M	34.88		34.83	32.22	24.90	22.15	19.60		21.84
	5M	24.49		23.87	21.65	14.23	12.39	10.80		11.01
Average Gain(dBi)										
MIMO_1	30cm	-3.32		-2.39	-1.56	-2.90	-3.68	-4.23		-2.45
	1M	-3.83		-2.99	-2.16	-3.75	-4.55	-5.13		-3.52
	2M	-4.60		-3.81	-3.04	-4.98	-5.81	-6.42		-4.99
	3M	-5.38		-4.65	-3.88	-6.20	-7.08	-7.72		-6.48
	5M	-6.92		-6.29	-5.61	-8.63	-9.61	-10.32		-9.45
MIMO_2	30cm	-2.52		-2.32	-2.59	-2.74	-3.17	-3.62		-2.59
	1M	-3.03		-2.92	-3.19	-3.60	-4.03	-4.52		-3.65
	2M	-3.80		-3.74	-4.08	-4.83	-5.29	-5.81		-5.12
	3M	-4.58		-4.58	-4.92	-6.04	-6.57	-7.11		-6.61
	5M	-6.12		-6.22	-6.65	-8.47	-9.09	-9.70		-9.59
Peak Gain(dBi)										
MIMO_1	30cm	2.01		2.69	3.32	2.88	2.12	1.94		6.91
	1M	1.51		2.09	2.72	1.98	1.32	1.04		5.91
	2M	0.71		1.19	1.82	0.78	0.02	-0.36		4.41
	3M	-0.09		0.39	1.02	-0.42	-1.18	-1.66		2.89
	5M	-1.69		-1.31	-0.68	-2.72	-3.68	-4.26		-0.19
MIMO_2	30cm	4.06		2.55	2.55	3.27	2.59	3.26		5.99
	1M	3.56		1.95	1.95	2.37	1.79	2.36		4.99
	2M	2.86		1.15	1.15	1.17	0.49	0.96		3.49
	3M	2.06		0.25	0.25	-0.03	-0.71	-0.34		1.99
	5M	0.56		-1.36	-1.45	-2.39	-3.21	-3.14		-1.09
Envelope Correlation Coefficient			All bands <0.3							
Impedance			50Ω							
Polarization			Linear							
VSWR			All bands < 3.5							
Cable			0.3M RG174 standard, fully customizable							
Connector			SMA(M) / RP-SMA(M) standard, fully customizable							

2.4GHz/5GHz Wi-Fi Antenna			
Frequency (MHz)		2400~2500	4900~5850
Efficiency (%)			
MIMO_1	30cm	50.34	48.64
	1M	39.54	34.11
	2M	28.65	20.75
	3M	20.28	12.45
	5M	10.53	4.55
MIMO_2	30cm	54.35	44.84
	1M	42.78	31.39
	2M	30.99	19.09
	3M	21.94	11.45
	5M	11.39	4.18
Average Gain(dBi)			
MIMO_1	30cm	-3.00	-3.16
	1M	-4.05	-4.70
	2M	-5.45	-6.86
	3M	-6.95	-9.08
	5M	-9.97	-13.46
MIMO_2	30cm	-2.65	-3.52
	1M	-3.70	-5.06
	2M	-5.10	-7.22
	3M	-6.60	-9.44
	5M	-9.44	-13.82
Peak Gain(dBi)			
MIMO_1	30cm	3.89	5.25
	1M	2.79	3.65
	2M	1.39	1.42
	3M	-0.11	-0.77
	5M	-3.01	-4.97
MIMO_2	30cm	3.88	5.46
	1M	2.78	3.96
	2M	1.38	1.86
	3M	-0.12	-0.34
	5M	-2.98	-4.64
Envelope Correlation Coefficient	2400MHz to 2500MHz <0.3 4900MHz to 5850MHz <0.3		
Impedance	50Ω		
Polarization	Linear		
VSWR	2400MHz to 2500MHz < 2.0 4900MHz to 5850MHz < 3.5		
Cable Connector	0.3M RG174 standard, fully customizable RP-SMA(M) standard, fully customizable		

MECHANICAL	
Dimensions	Diameter: 94.3mm, Height: 57.4 mm
Casing	ASA
Base and thread	Zinc Alloy
Weight	250g
Ingress Protection Rating	IP69K
Maximum Assembly Torque	39.2 N•m
ENVIRONMENTAL	
Operation Temperature	-40°C to 85°C
Storage Temperature	-40°C to 85°C
Humidity	Non-condensing 65°C 95% RH

LTE BANDS				
Band Number	LTE / LTE-Advanced / WCDMA / HSPA / HSPA+ / TD-SCDMA			
	Uplink	Downlink	MIMO 1	MIMO 2
1	UL: 1920 to 1980	DL: 2110 to 2170	✓	✓
2	UL: 1850 to 1910	DL: 1930 to 1990	✓	✓
3	UL: 1710 to 1785	DL: 1805 to 1880	✓	✓
4	UL: 1710 to 1755	DL: 2110 to 2155	✓	✓
5	UL: 824 to 849	DL: 869 to 894	✓	✓
7	UL: 2500 to 2570	DL: 2620 to 2690	✓	✓
8	UL: 880 to 915	DL: 925 to 960	✓	✓
9	UL: 1749.9 to 1784.9	DL: 1844.9 to 1879.9	✓	✓
11	UL: 1427.9 to 1447.9	DL: 1475.9 to 1495.9	✗	✗
12	UL: 699 to 716	DL: 729 to 746	✓	✓
13	UL: 777 to 787	DL: 746 to 756	✓	✓
14	UL: 788 to 798	DL: 758 to 768	✓	✓
17	UL: 704 to 716	DL: 734 to 746 (LTE only)	✓	✓
18	UL: 815 to 830	DL: 860 to 875 (LTE only)	✓	✓
19	UL: 830 to 845	DL: 875 to 890	✓	✓
20	UL: 832 to 862	DL: 791 to 821	✓	✓
21	UL: 1447.9 to 1462.9	DL: 1495.9 to 1510.9	✗	✗
22	UL: 3410 to 3490	DL: 3510 to 3590	✗	✗
23	UL: 2000 to 2020	DL: 2180 to 2200 (LTE only)	✓	✓
24	UL: 1625.5 to 1660.5	DL: 1525 to 1559 (LTE only)	✓	✓
25	UL: 1850 to 1915	DL: 1930 to 1995	✓	✓
26	UL: 814 to 849	DL: 859 to 894	✓	✓
27	UL: 807 to 824	DL: 852 to 869 (LTE only)	✓	✓
28	UL: 703 to 748	DL: 758 to 803 (LTE only)	✓	✓
29	UL: -	DL: 717 to 728 (LTE only)	✓	✓
30	UL: 2305 to 2315	DL: 2350 to 2360 (LTE only)	✓	✓
31	UL: 452.5 to 457.5	DL: 462.5 to 467.5 (LTE only)	✗	✗
32	UL: -	DL: 1452 - 1496	✗	✗
35		1850 to 1910	✓	✓
38		2570 to 2620	✓	✓
39		1880 to 1920	✓	✓
40		2300 to 2400	✓	✓
41		2496 to 2690	✓	✓
42		3400 to 3600	✗	✗
43		3600 to 3800	✗	✗

\*Covered bands represent an efficiency greater than 20%

### 3. Antenna Characteristics

#### 3.1. GPS-GLONASS-GALILEO-BeiDou Antenna

##### 3.1.1. Block Diagram

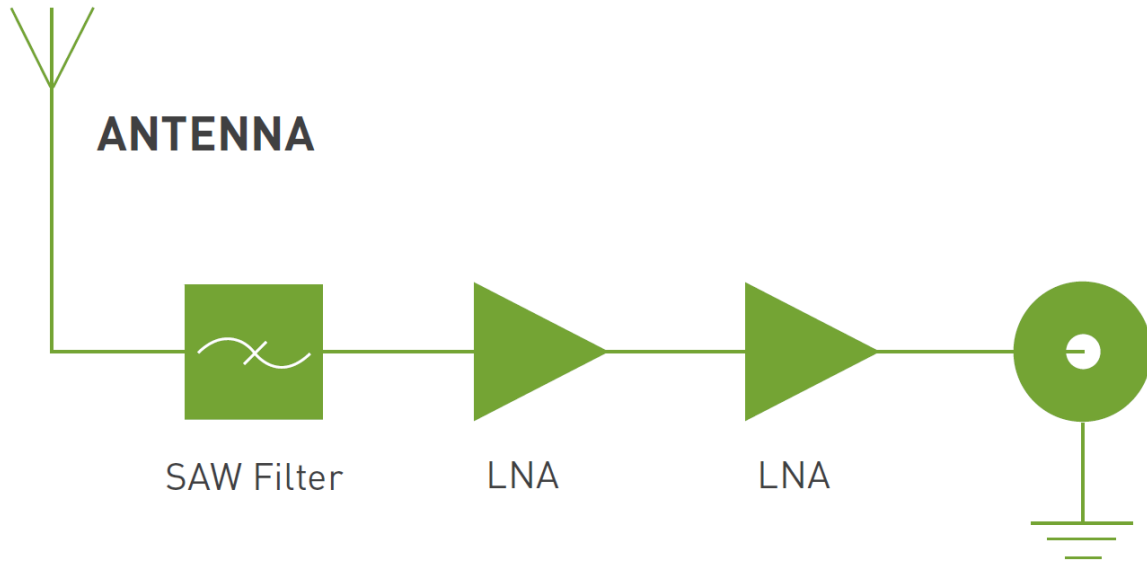



### 3.1.2. Test Setup

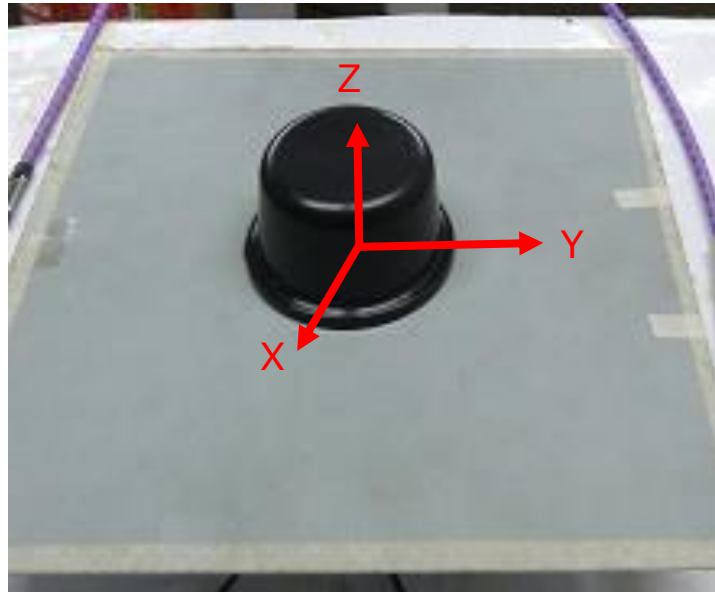

Ground plane: 30\*30cm

### 3.1.3. GPS-GLONASS-GALILEO-BeiDou Return Loss

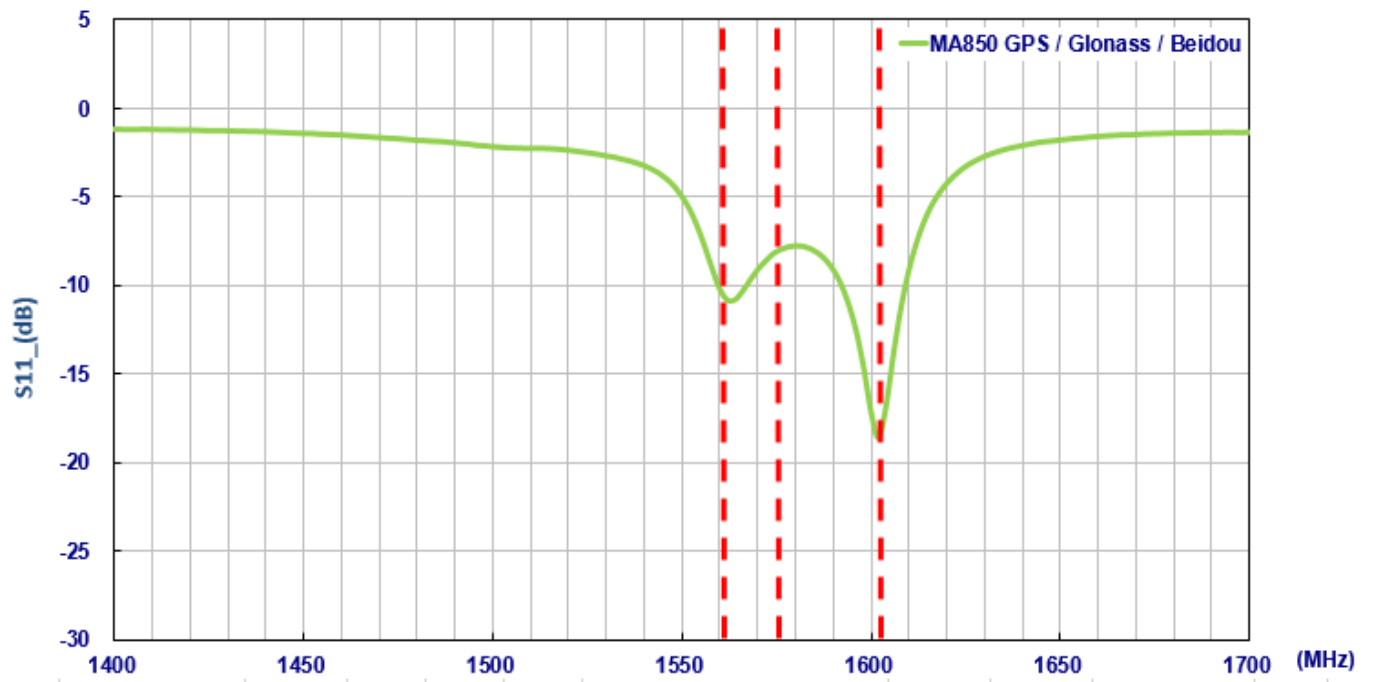

### 3.1.4. GPS-GLONASS-GALILEO-BeiDou VSWR

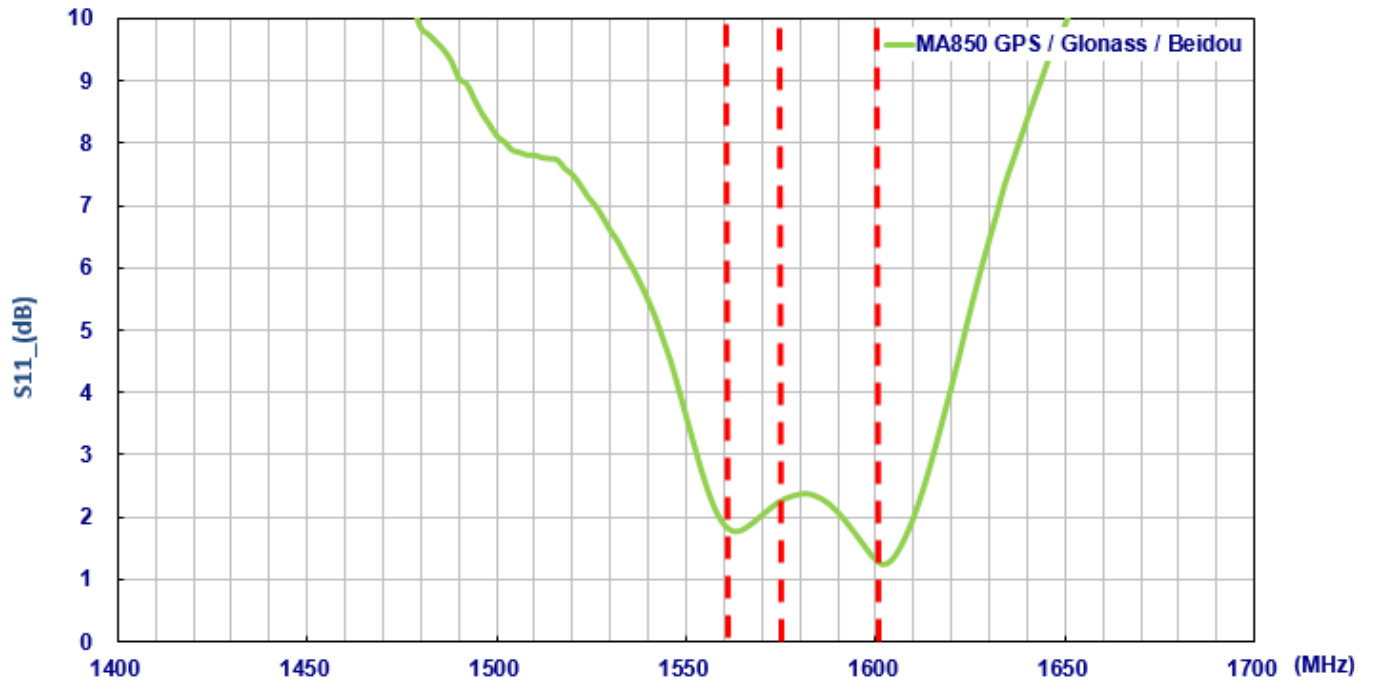

### 3.1.5. GPS-GLONASS-GALILEO-BeiDou Smith Chart

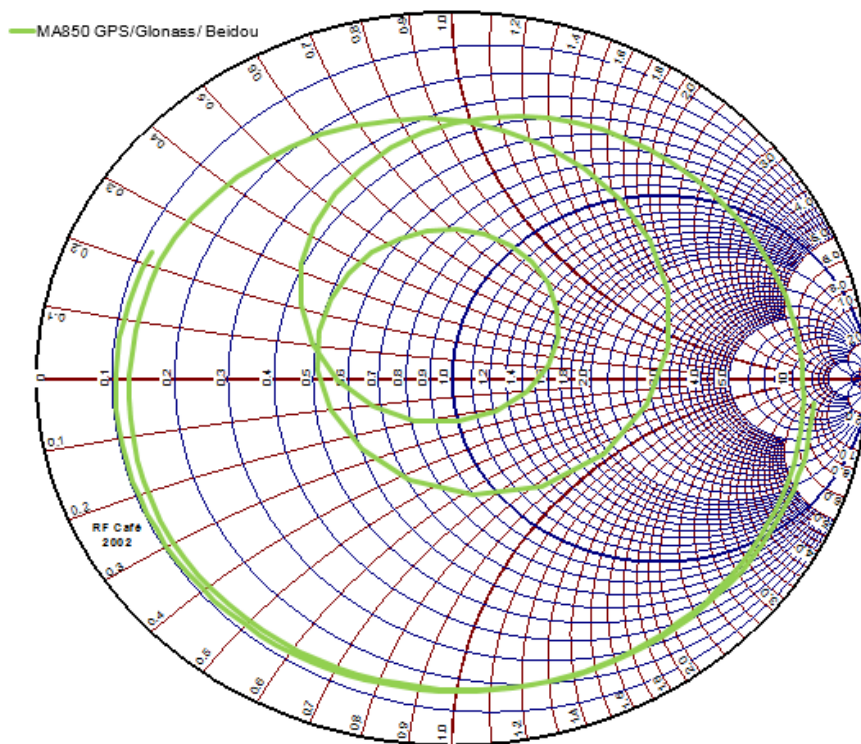

### 3.1.6 GPS-GLONASS-GALILEO-BeiDou Antenna Efficiency

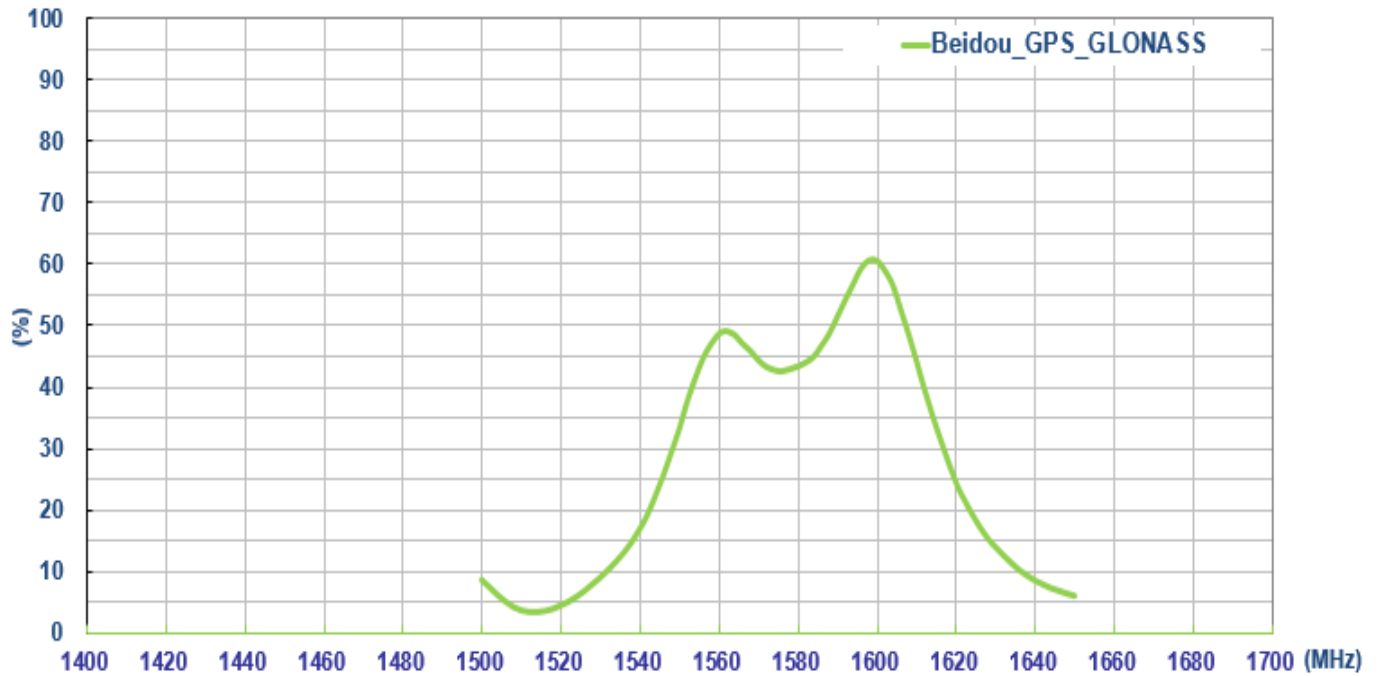

### 3.1.7 GPS-GLONASS-GALILEO-BeiDou Antenna Peak Gain

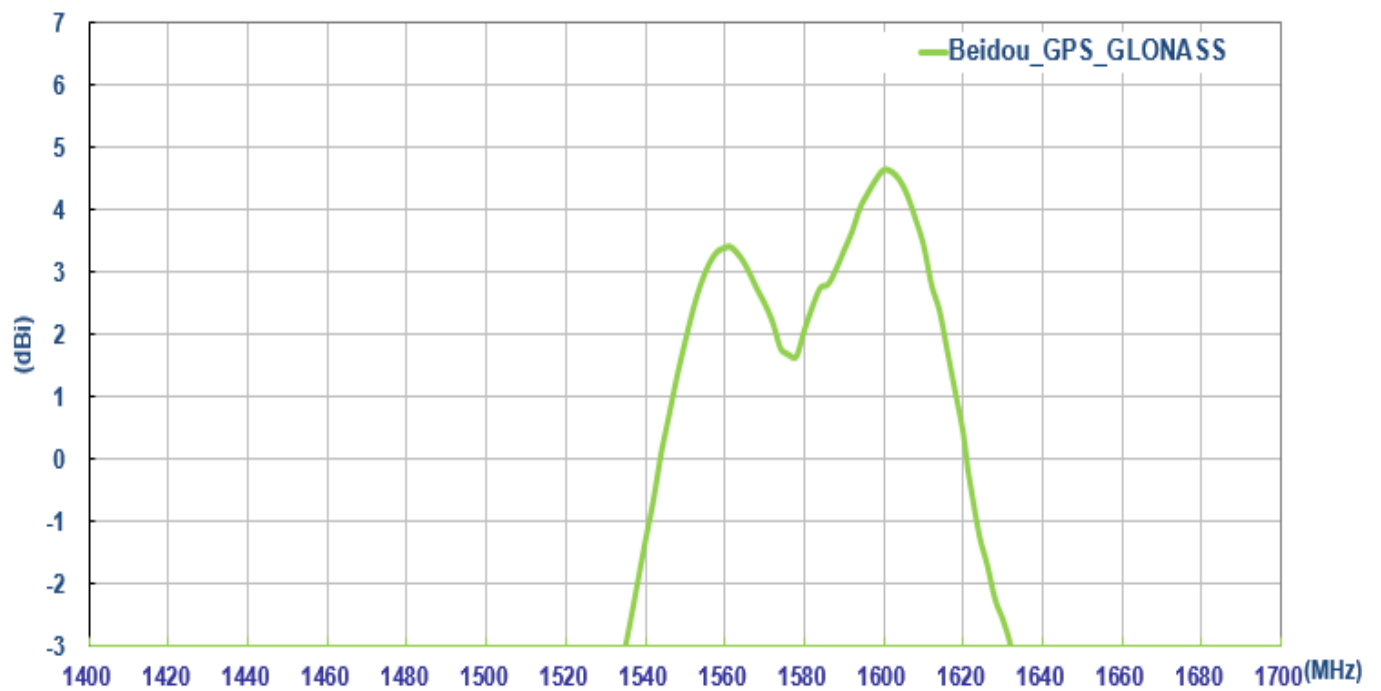

### 3.1.8 GPS-GLONASS-GALILEO-BeiDou Antenna Average Gain

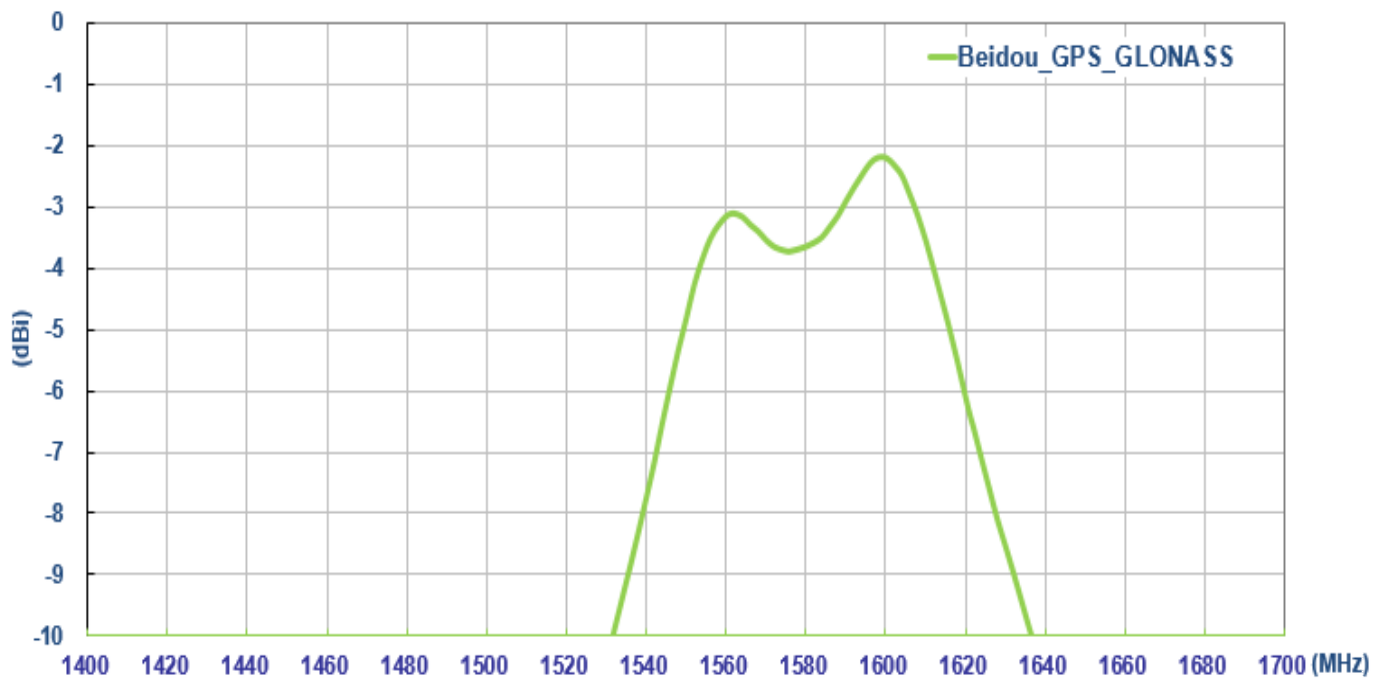

### 3.1.6. GPS-GLONASS-GALILEO-BeiDou Radiation Pattern (Passive antenna) 2D Radiation Pattern

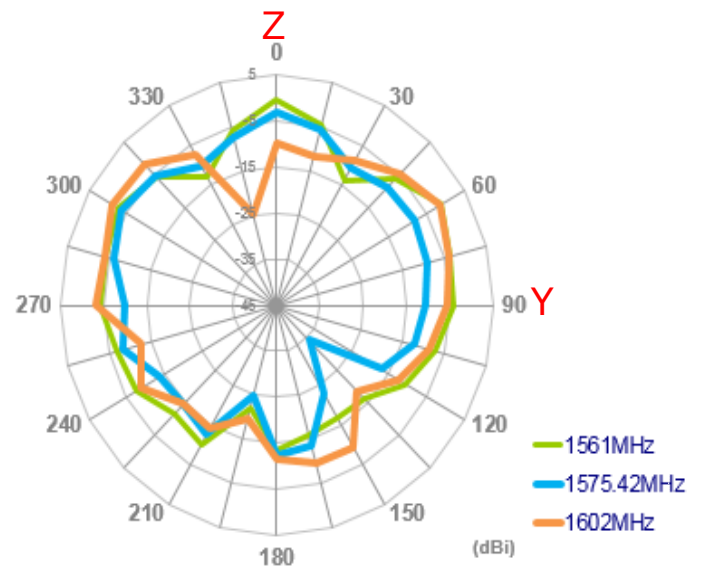
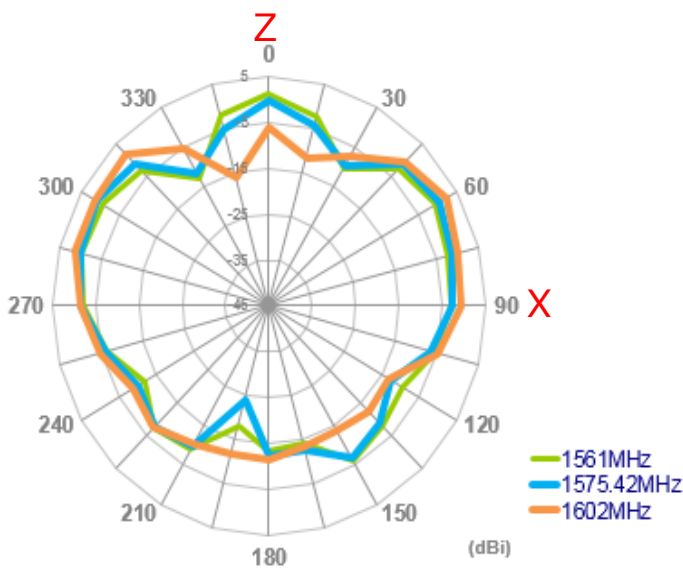
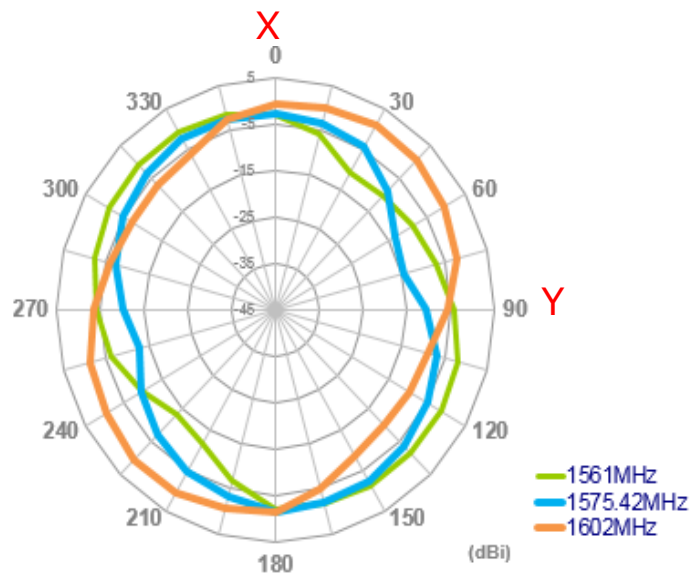

### 3.1.7. 3D Radiation Pattern (Passive antenna)

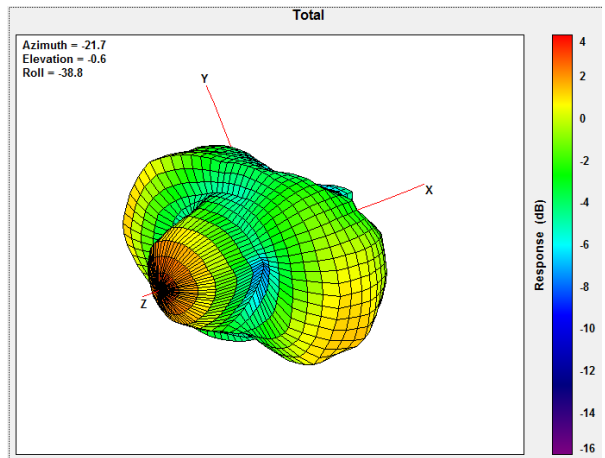

1561MHz

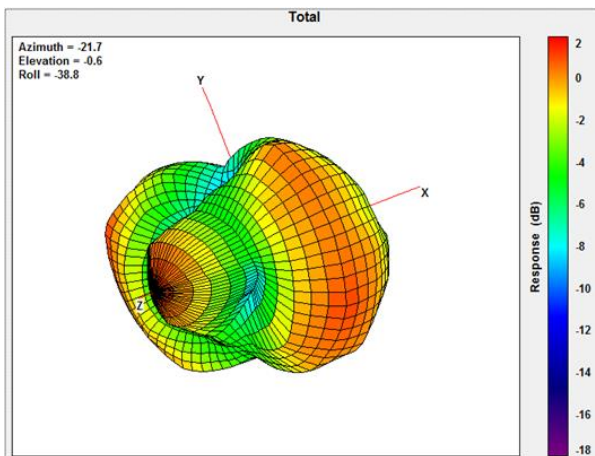

1575.42MHz

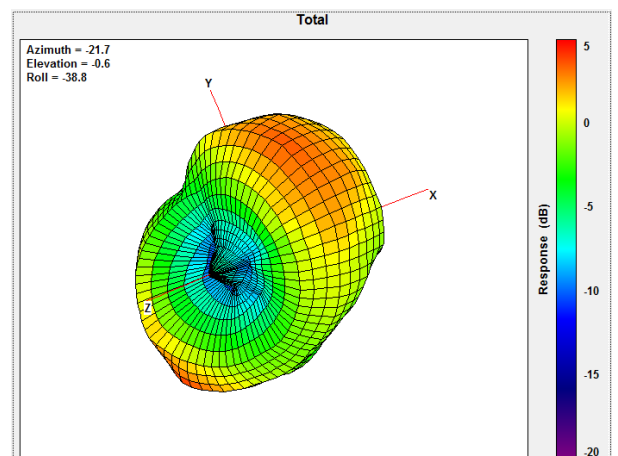

1602MHz

### 3.1.8. Axial Pattern (Passive antenna)

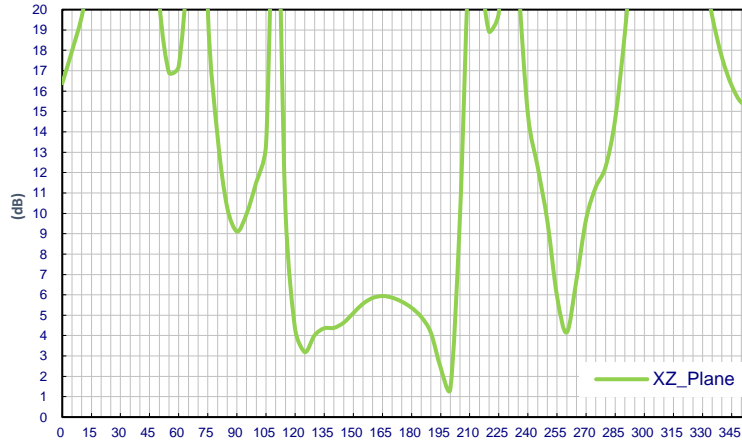

1561MHz

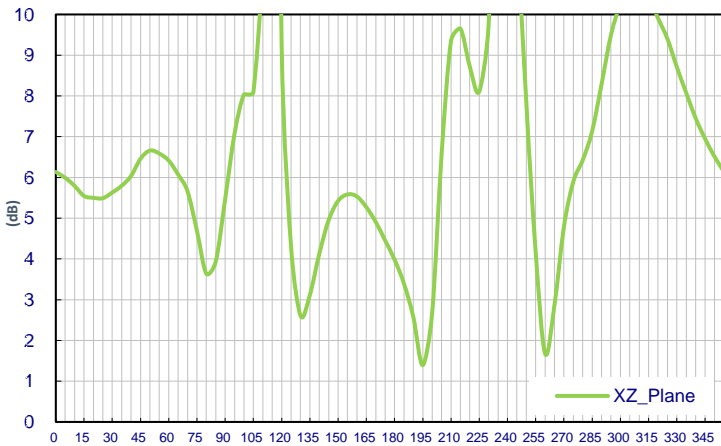

1575.42MHz

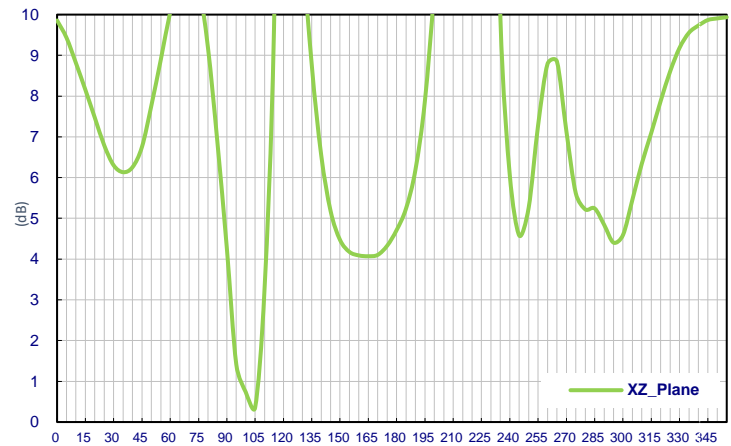

1602MHz

### 3.1.9. BeiDou-GPS-GLONASS LNA Gain and Noise Figure (Active antenna)

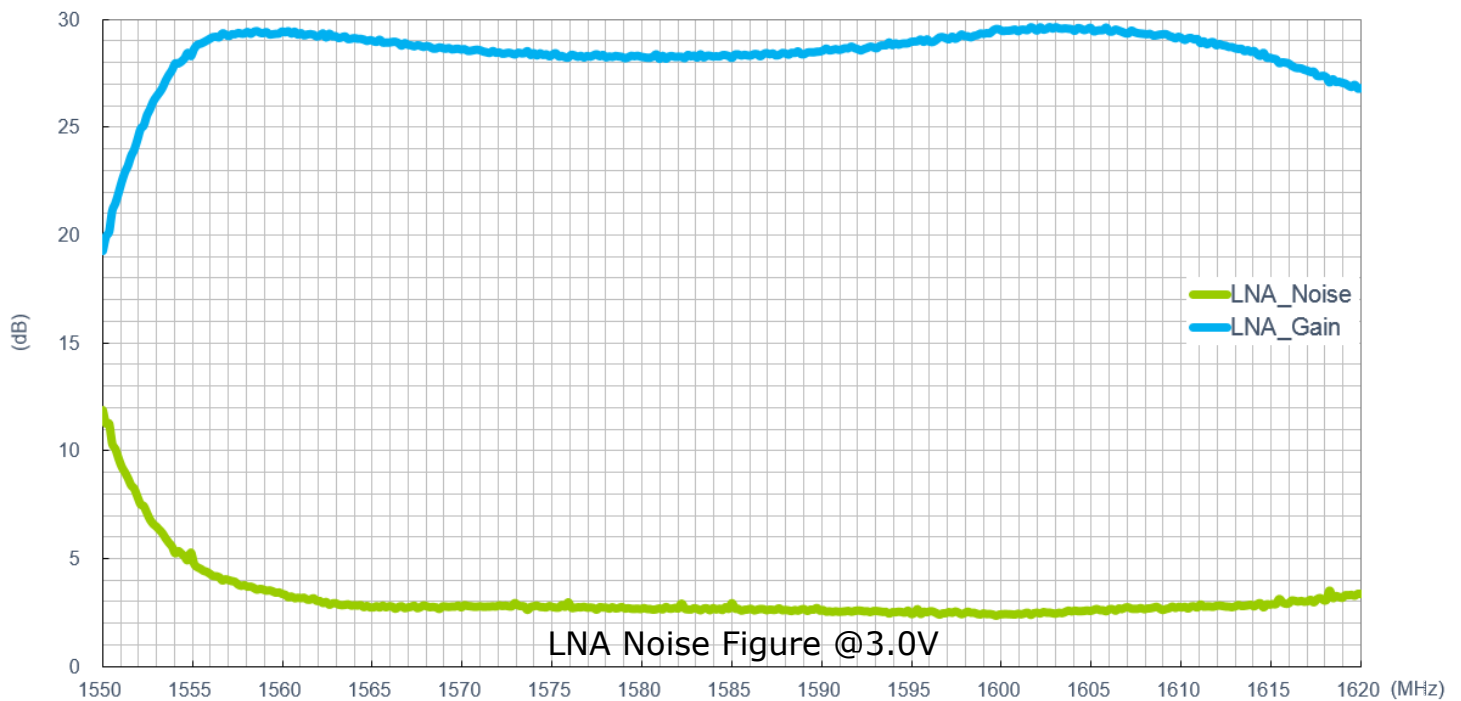
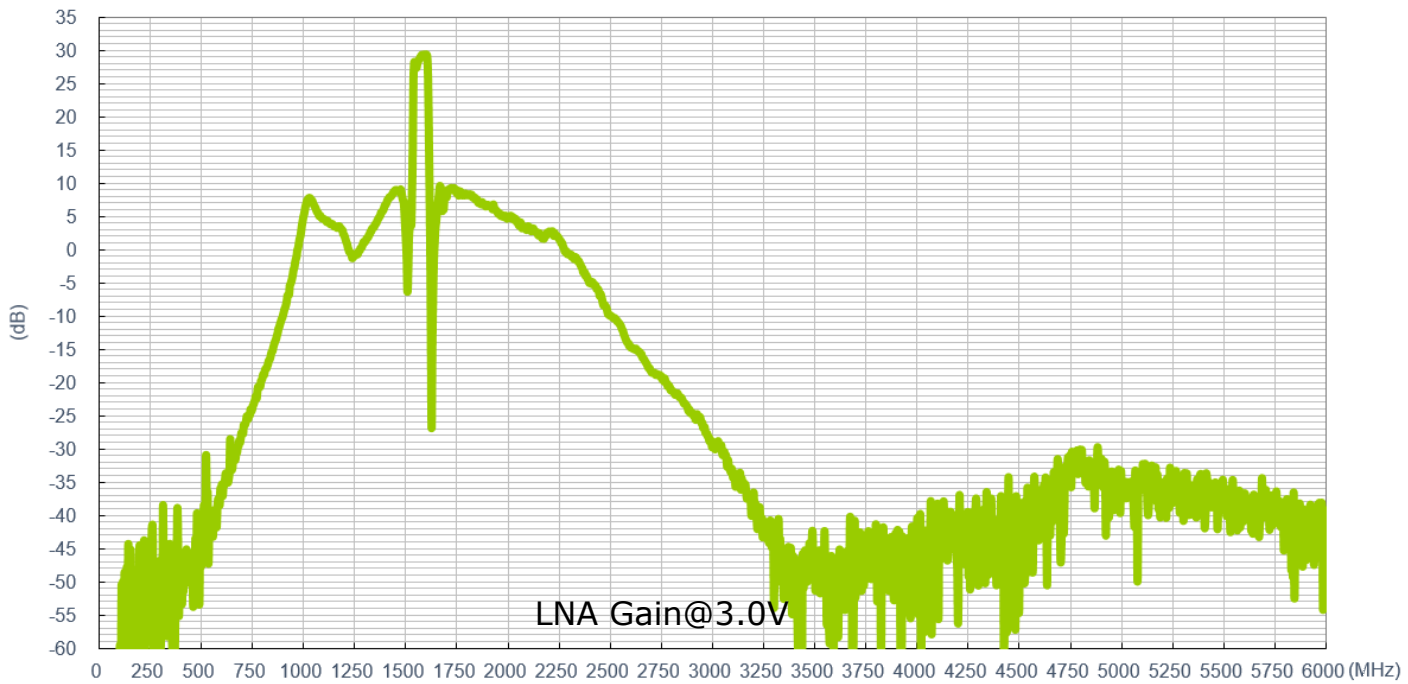



## 3.2. LTE MIMO & Wi-Fi MIMO Antenna

### 3.2.1. Test Setup

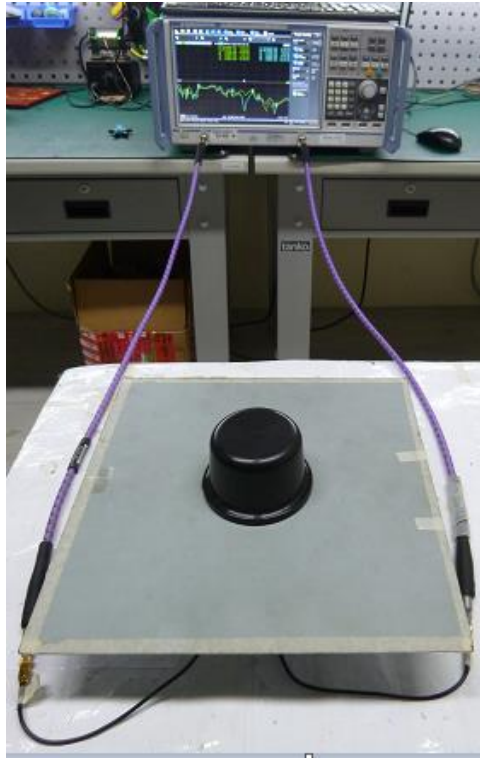

Ground plane: 30\*30cm

### 3.2.2. LTE Antenna Return Loss

Setup in free space with 0.3M cable length

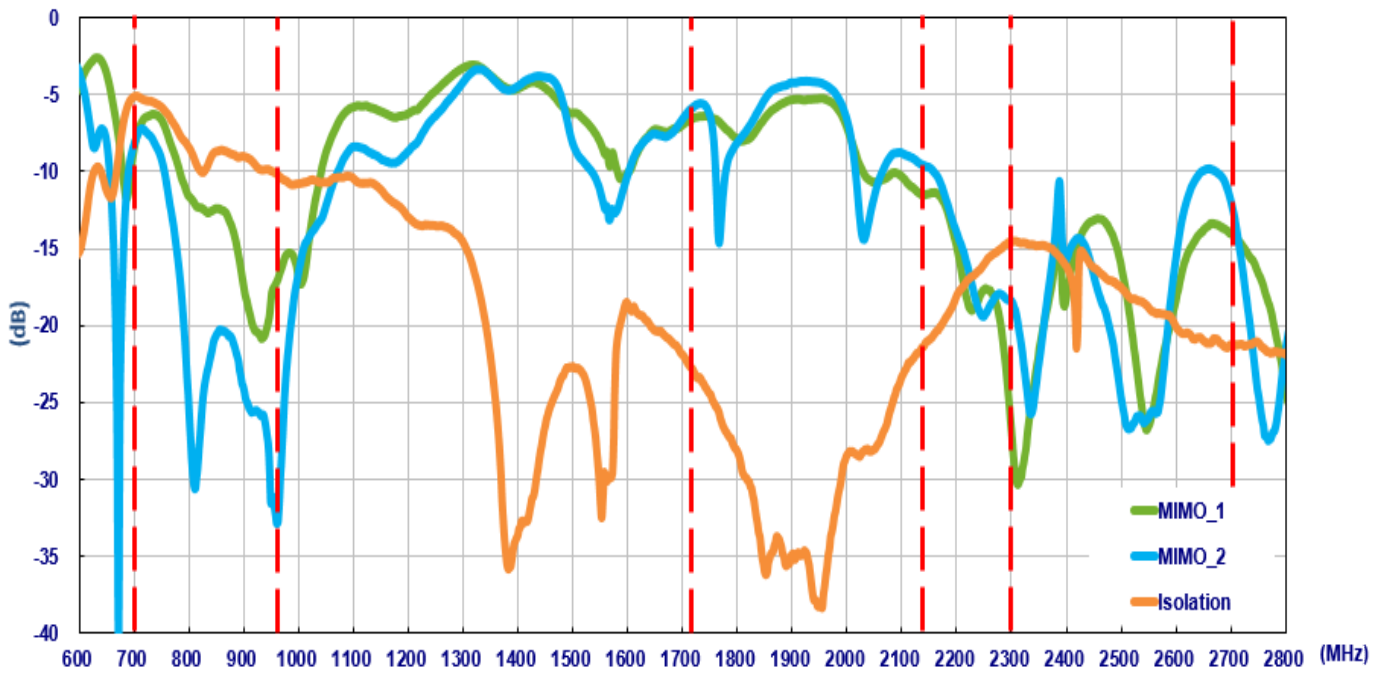

### 3.2.3. LTE Envelope Correlation Coefficient

Setup in free space with 0.3M cable length

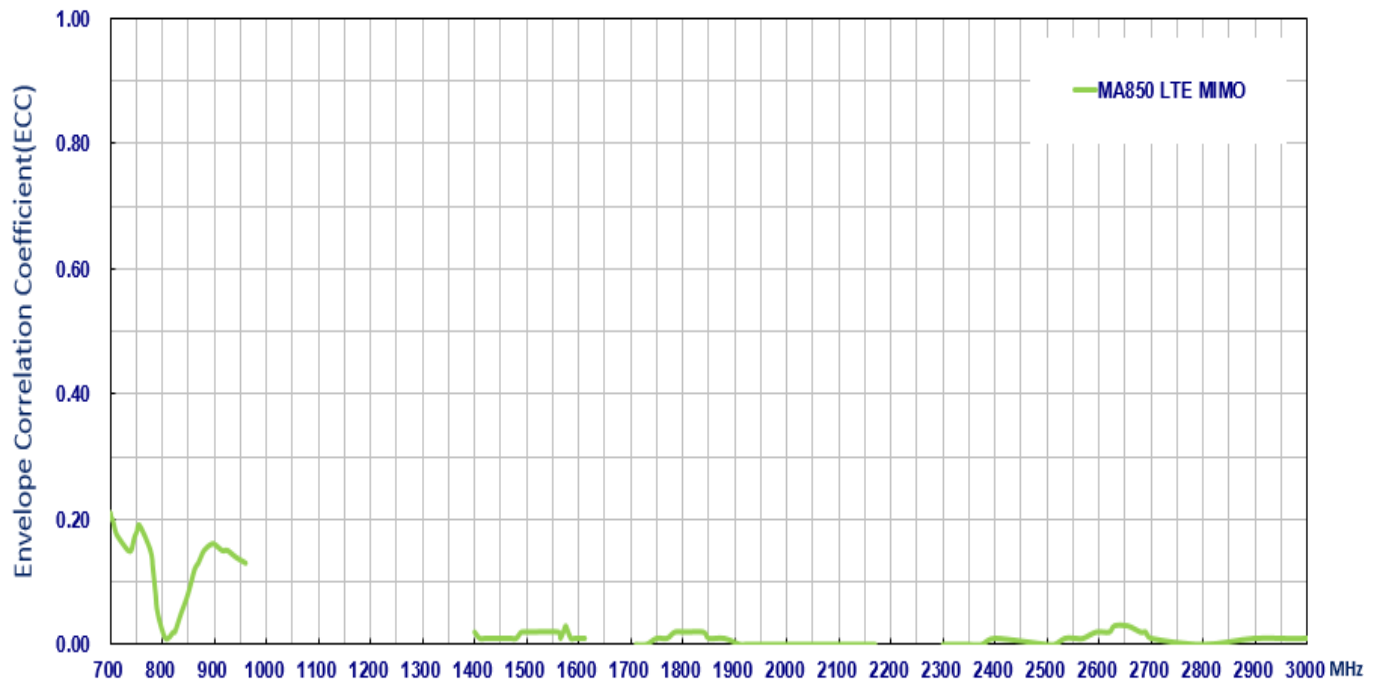

### 3.2.4. LTE Antenna Efficiency

Setup in free space with 0.3M cable length

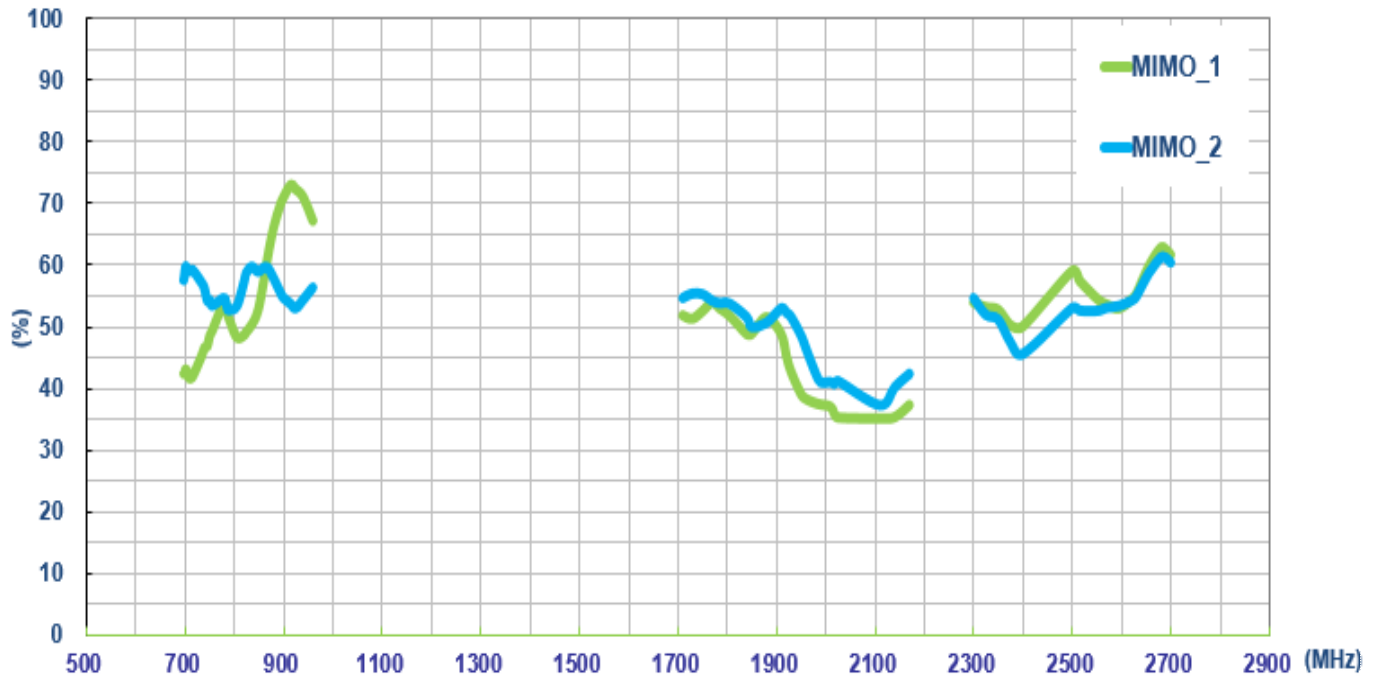

### 3.2.5. LTE Antenna Average Gain

Setup in free space with 0.3M cable length

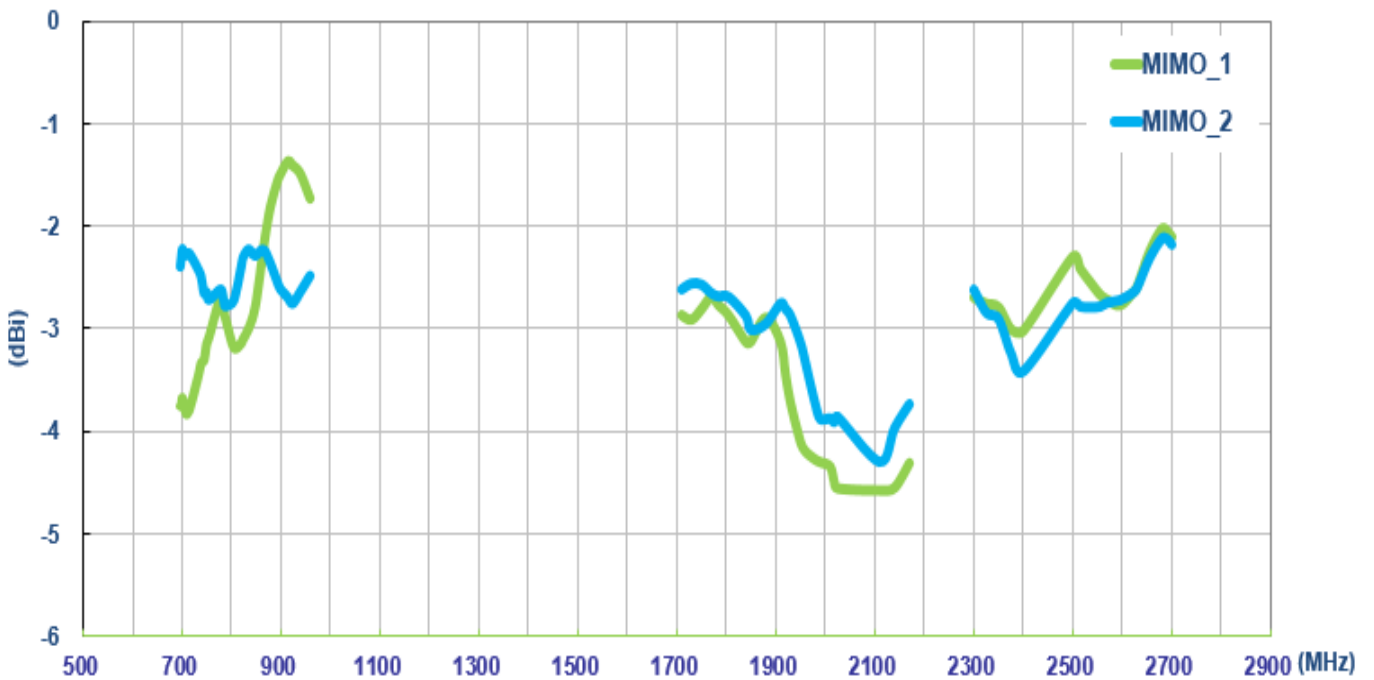

### 3.2.6. LTE Antenna Peak Gain

Setup in free space with 0.3M cable length

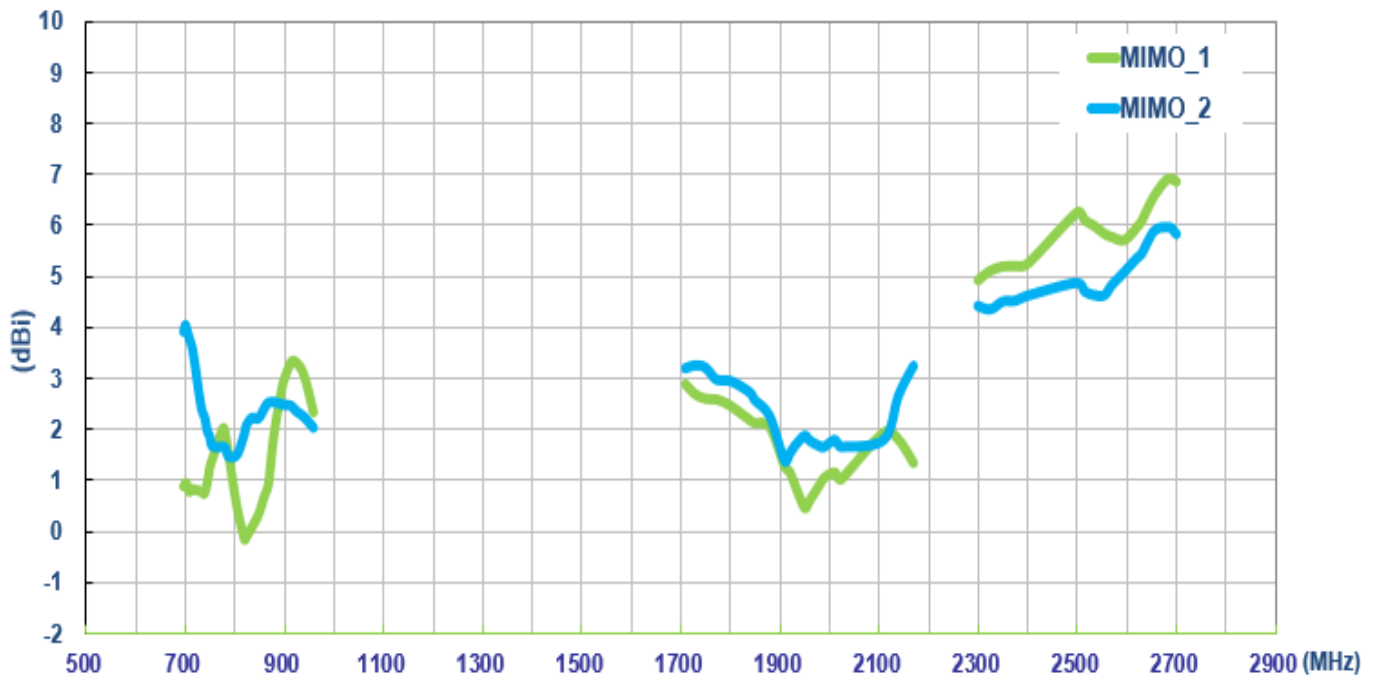

### 3.2.7. Wi-Fi Antenna Return Loss

Setup in free space with 0.3M cable length

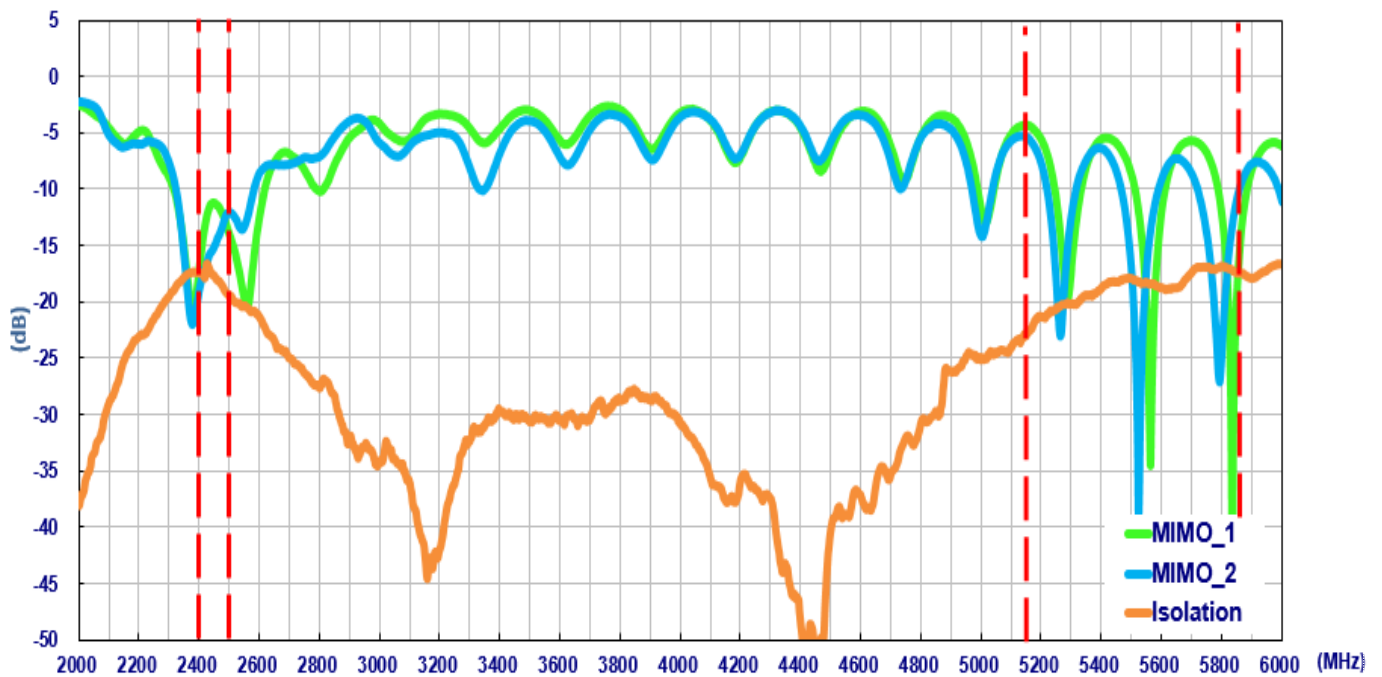

### 3.2.8. Wi-Fi Envelope Correlation Coefficient

Setup in free space with 0.3M cable length

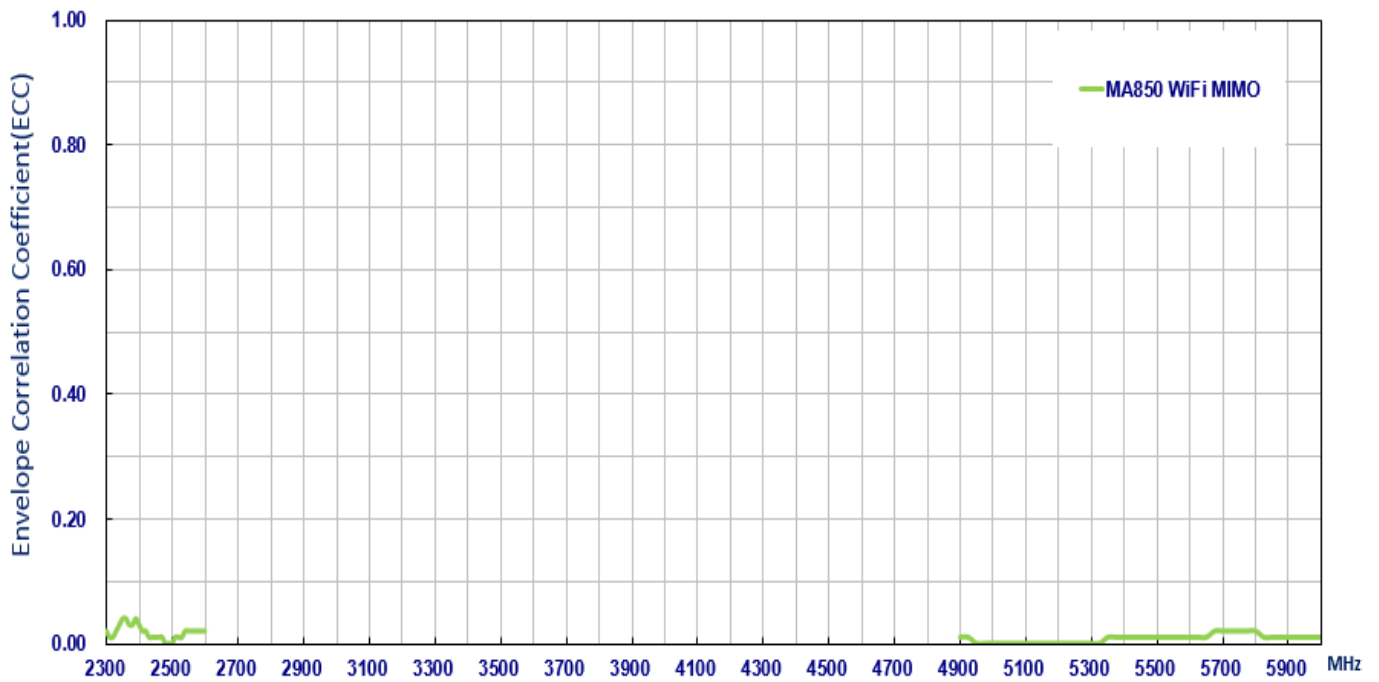

### 3.2.9. Wi-Fi Antenna Efficiency

Setup in free space with 0.3M cable length

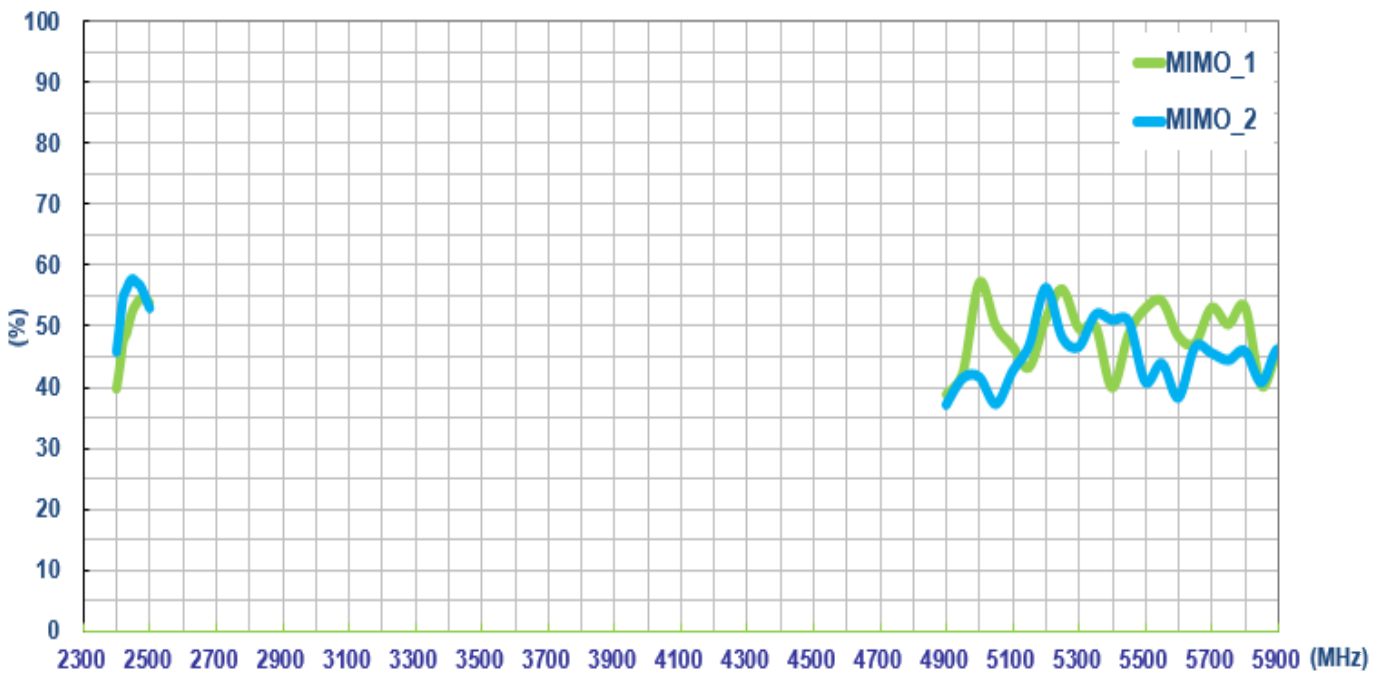

### 3.2.10. Wi-Fi Antenna Average Gain

Setup in free space with 0.3M cable length

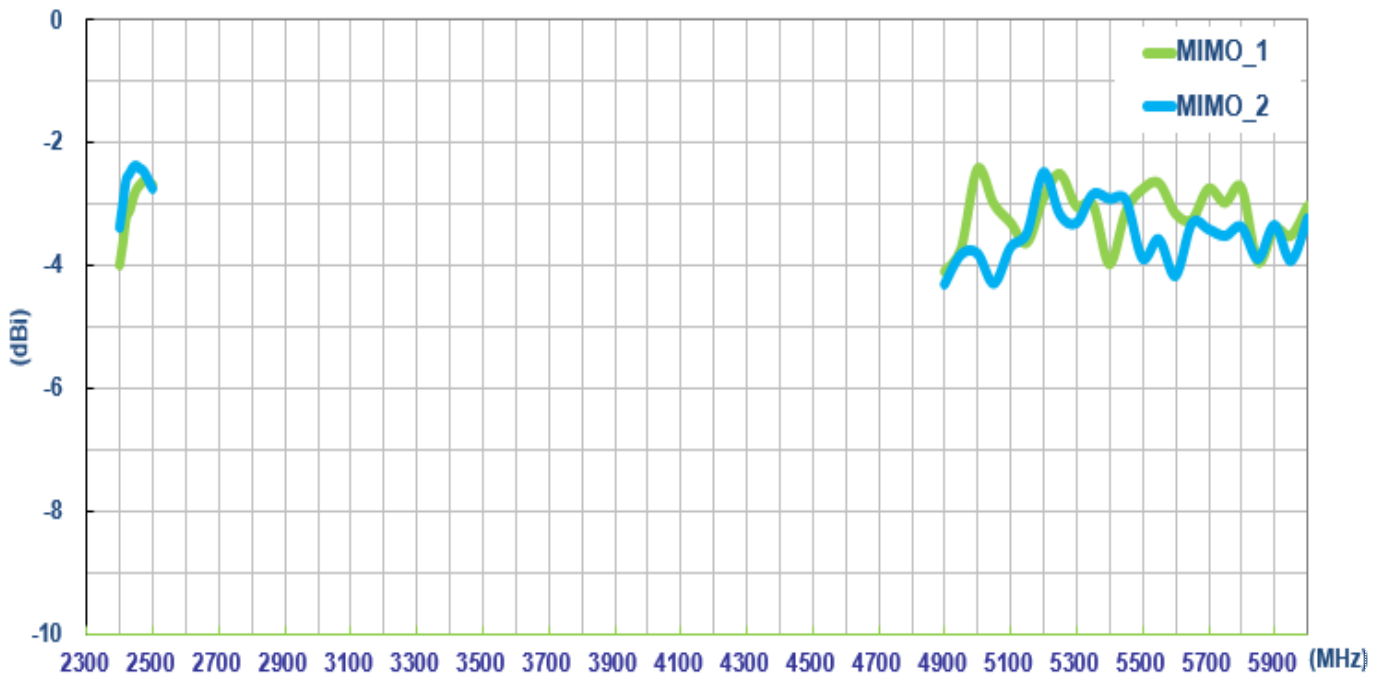

### 3.2.11. Wi-Fi Antenna Peak Gain

Setup in free space with 0.3M cable length

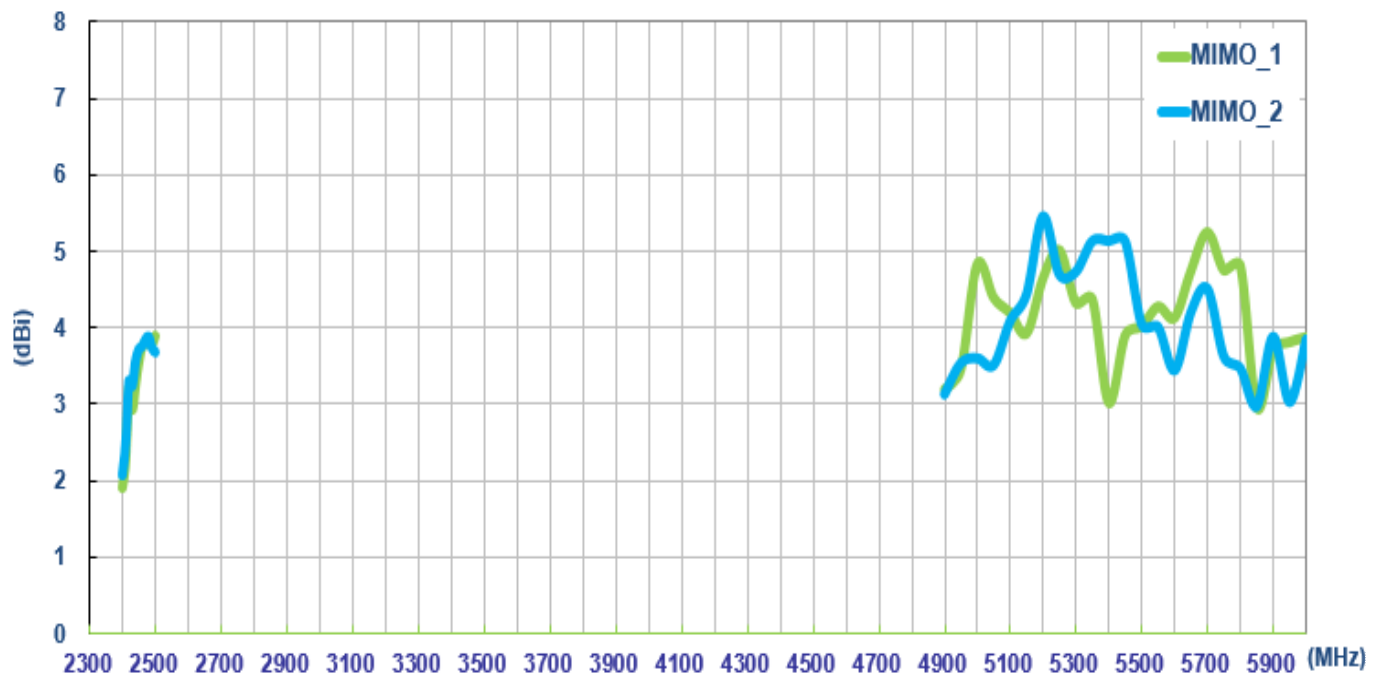

### 3.2.12. Test setup for antenna radiation pattern (ETS Anechoic chamber)

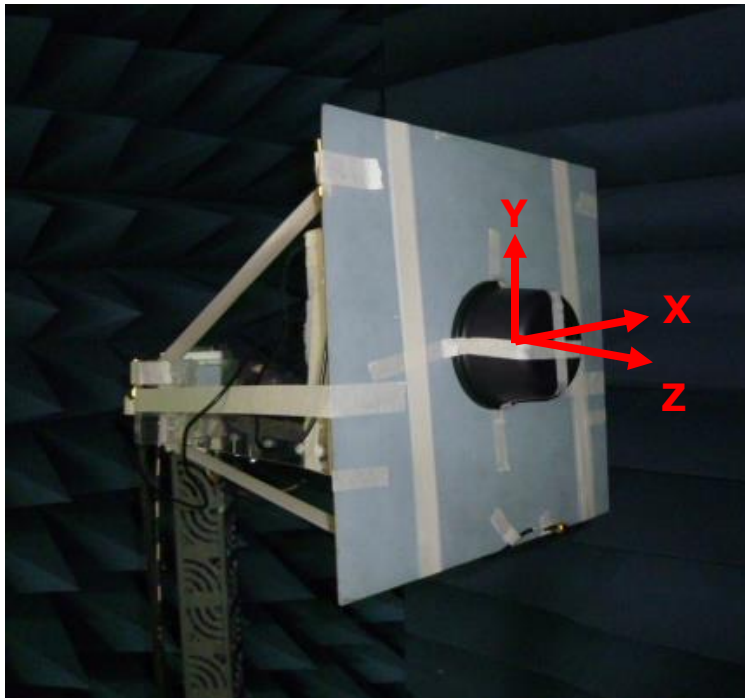

Testing Setup in ETS Anechoic Chamber

3.2.13. 2D Radiation Pattern (LTE MIMO1 with 0.3M cable length)  
XY Plane

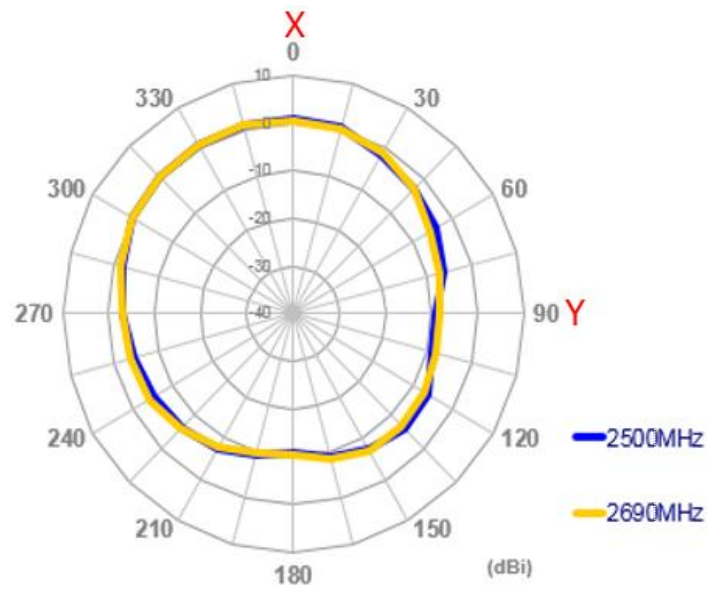
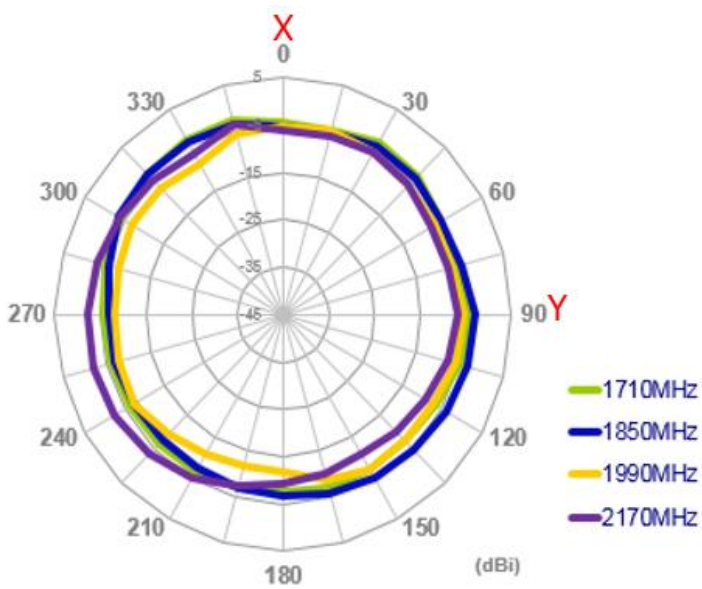
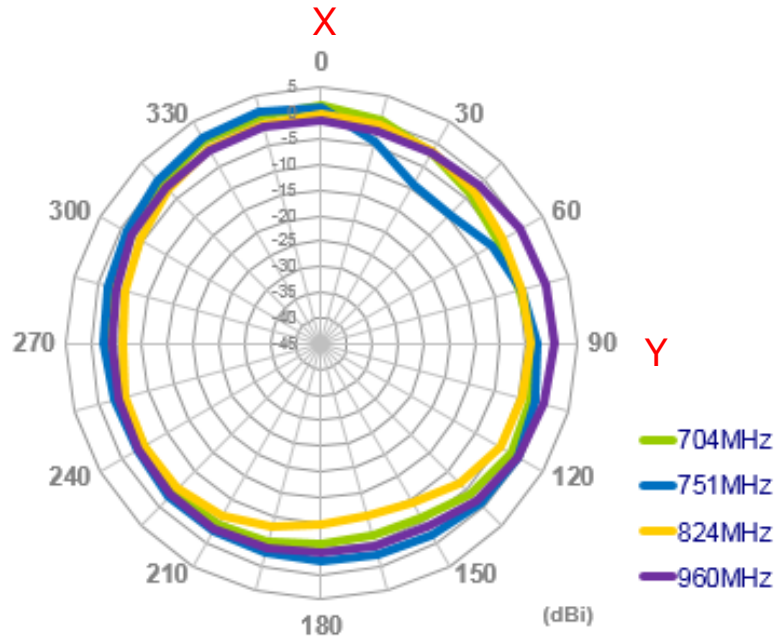



XZ Plane

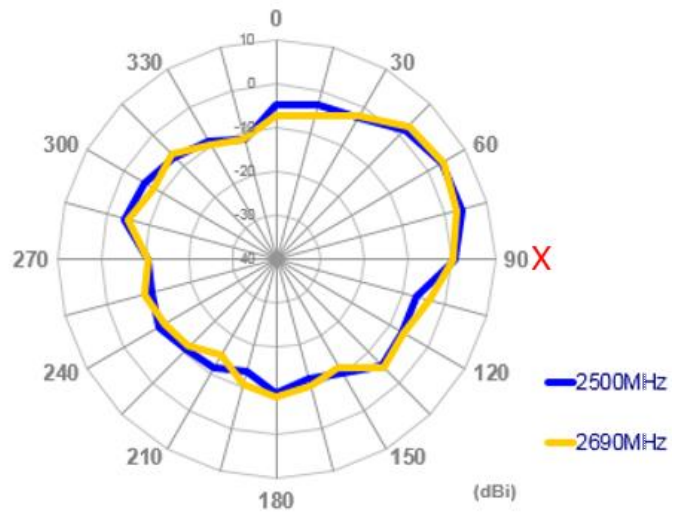
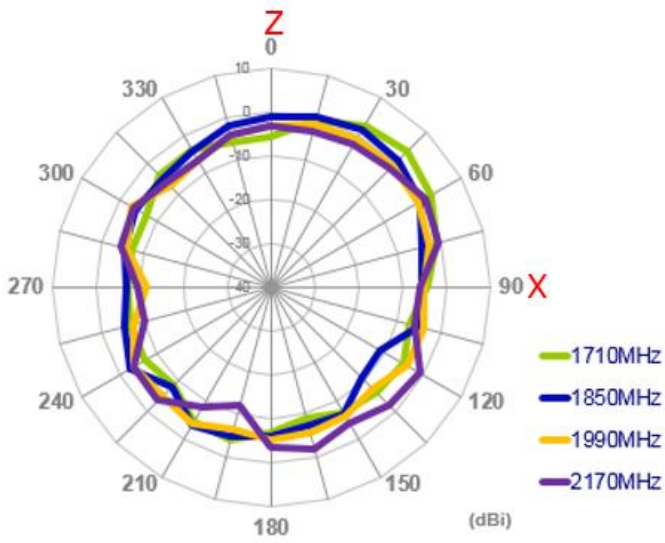
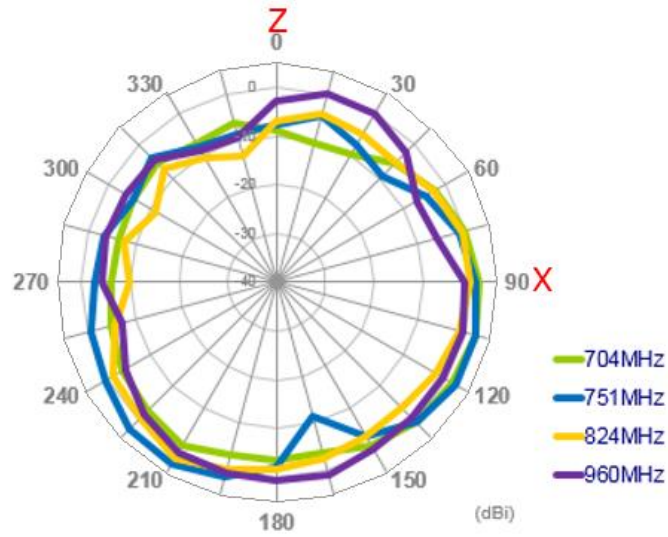

YZ Plane

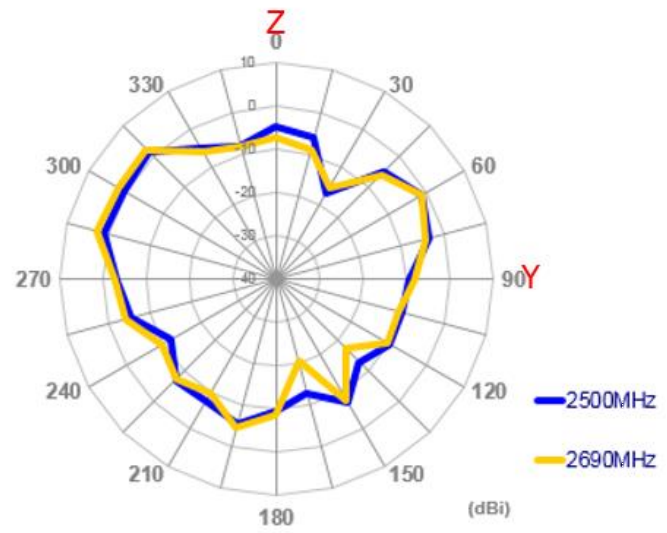
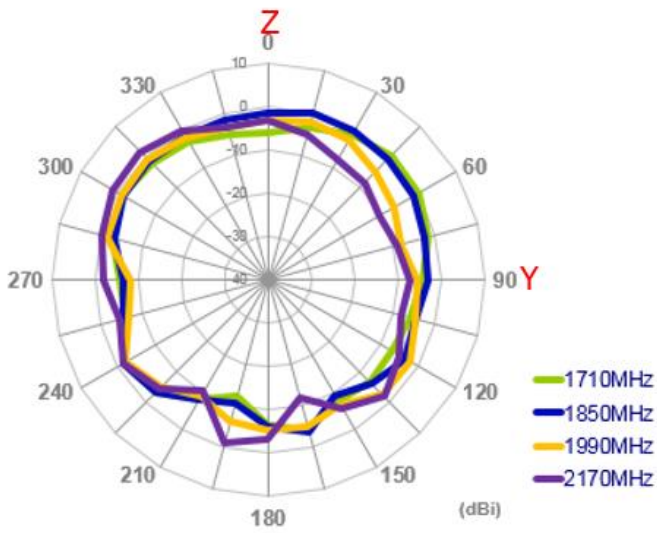
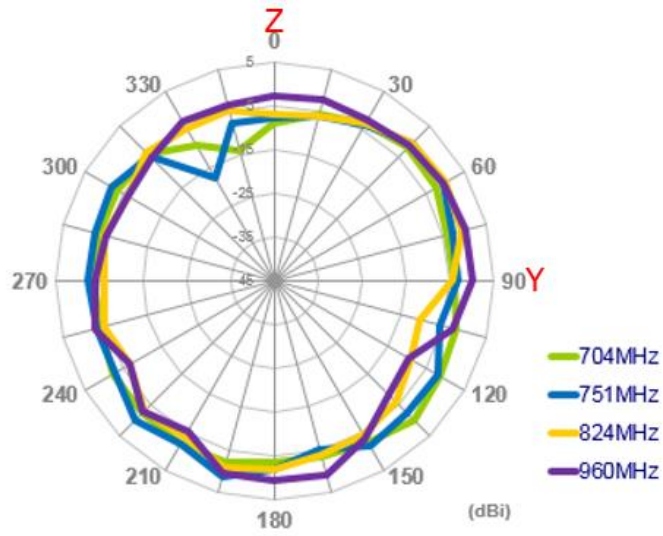

### 3.2.14. 3D Radiation Pattern (LTE MIMO1 with 0.3M cable length on the 30\*30cm ground plane)

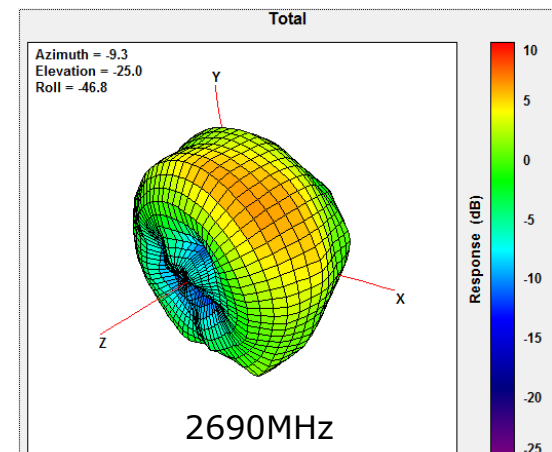
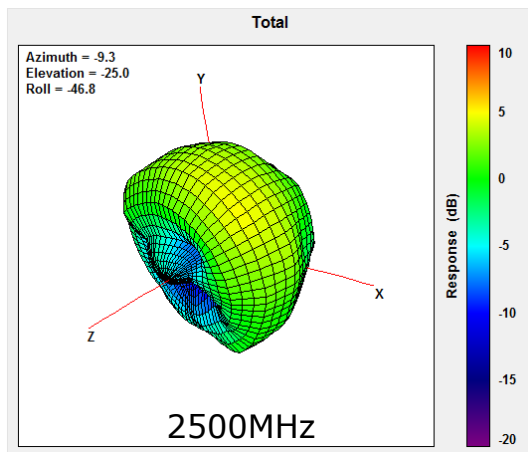
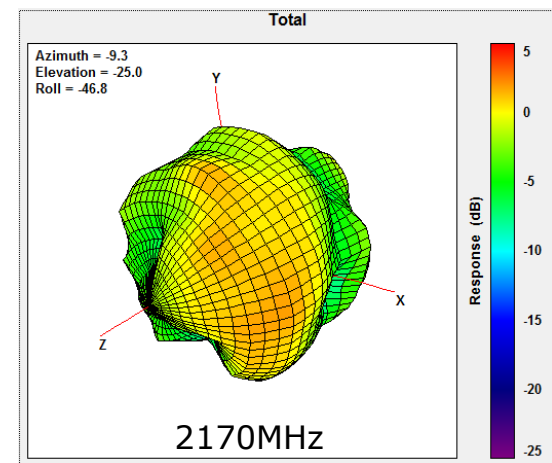
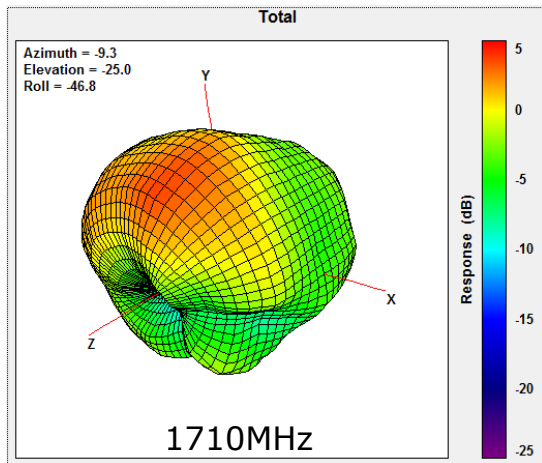
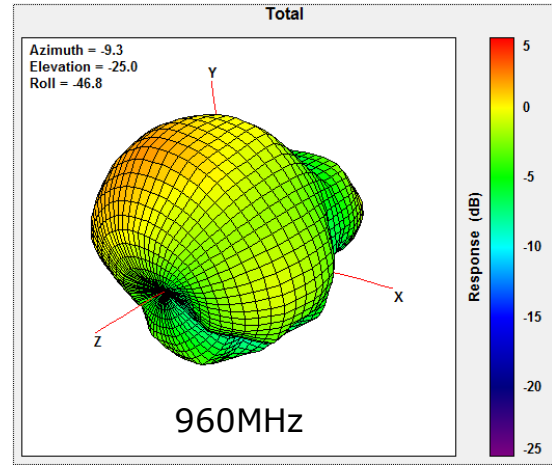
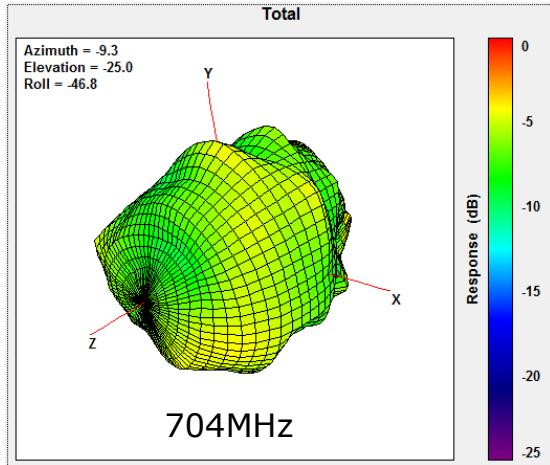

3.2.15. 2D Radiation Pattern (LTE MIMO2 with 0.3M cable length)  
XY Plane

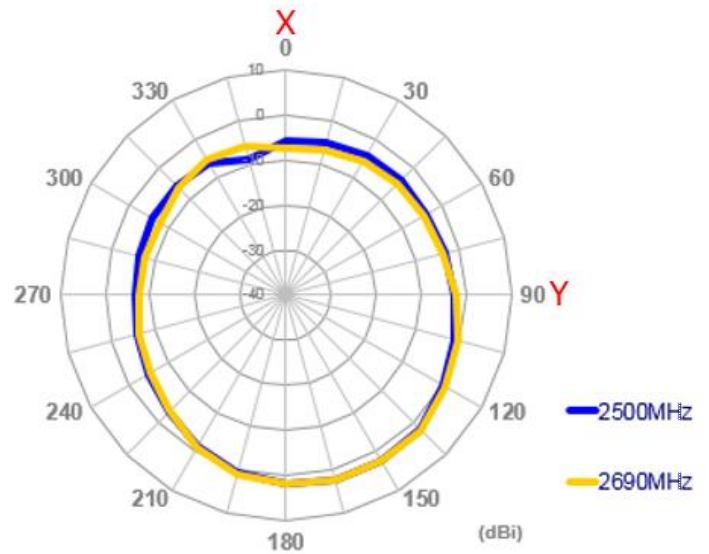
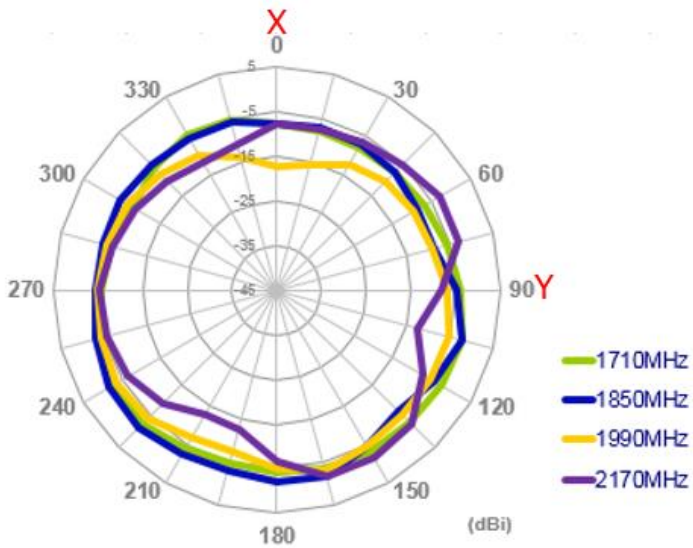
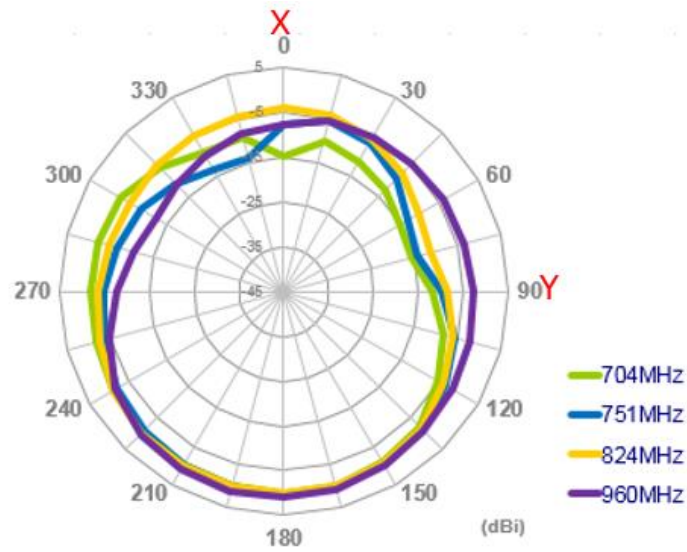

XZ Plane

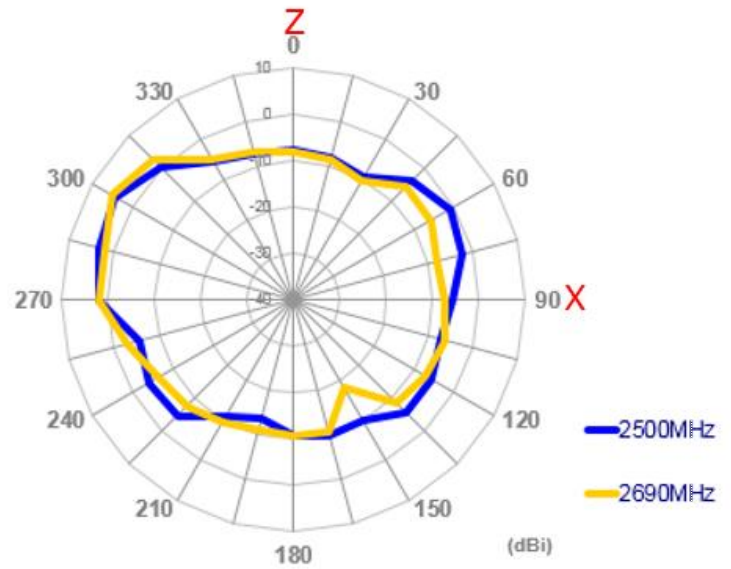
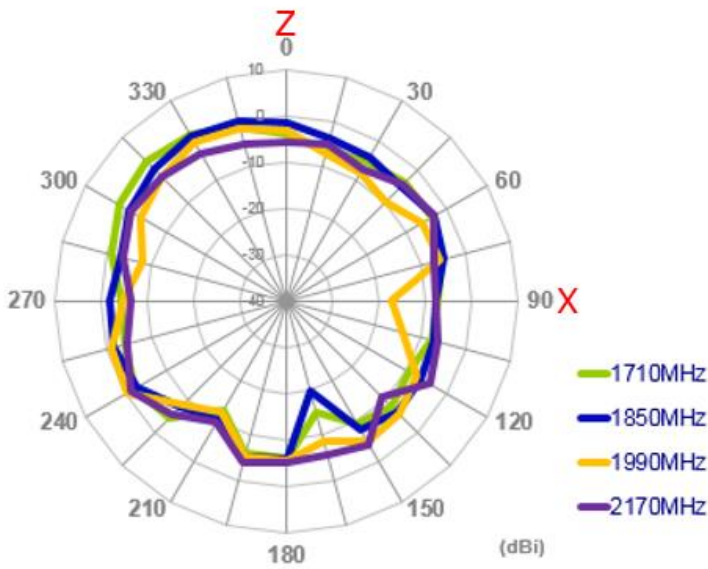
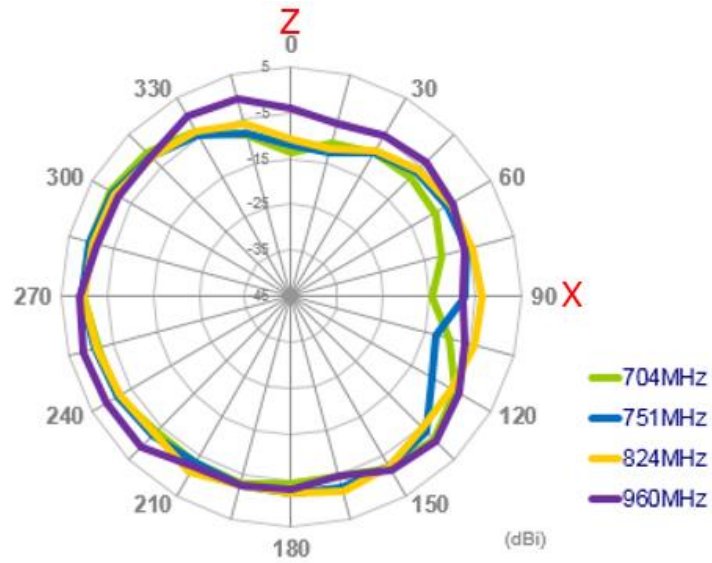

YZ Plane

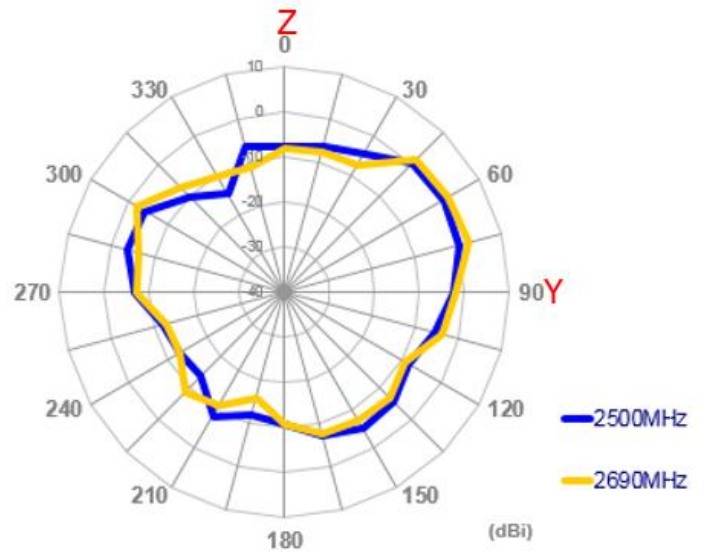
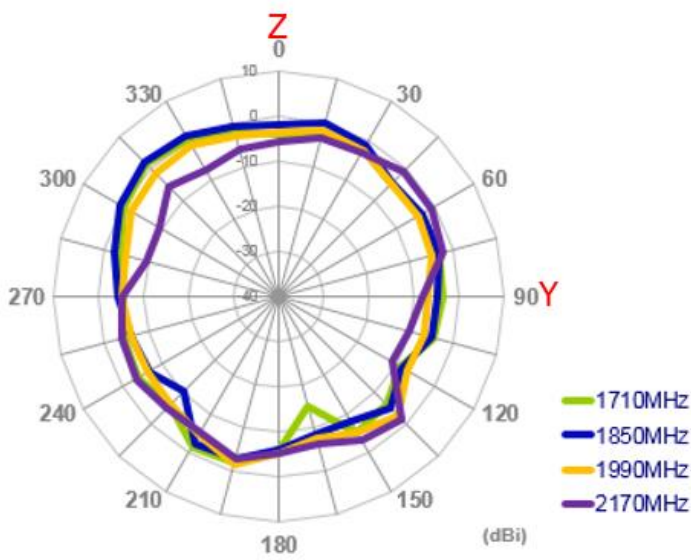
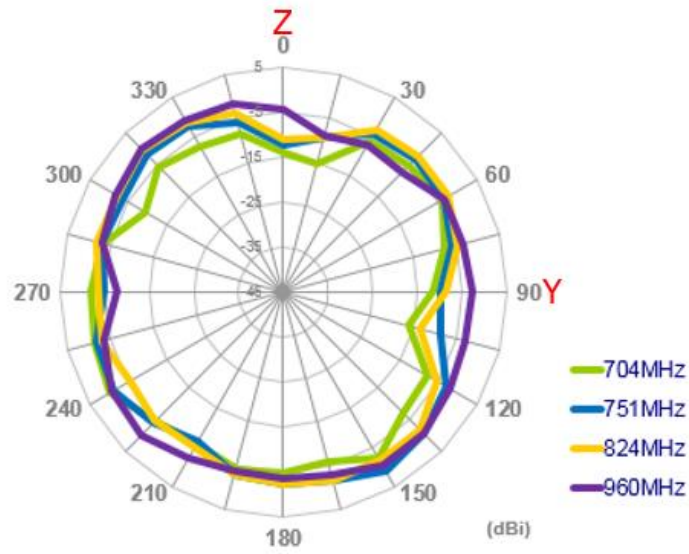

3.2.16. 3D Radiation Pattern (LTE MIMO2 with 0.3M cable length on the 30\*30cm ground plane)

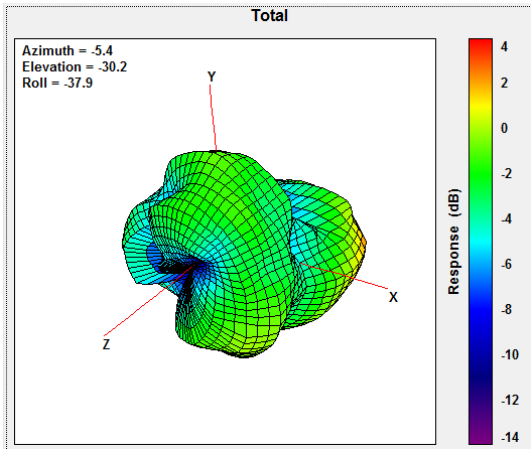

704MHz

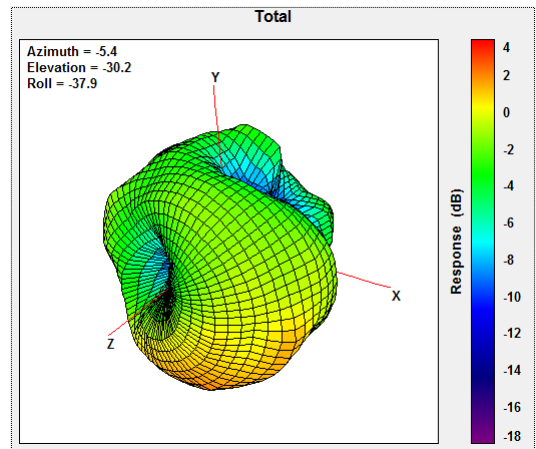

960MHz

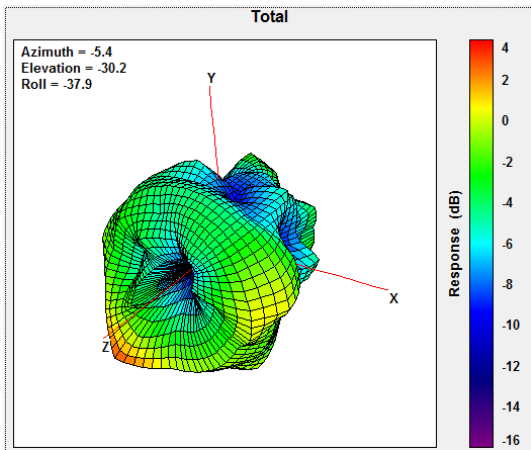

1710MHz

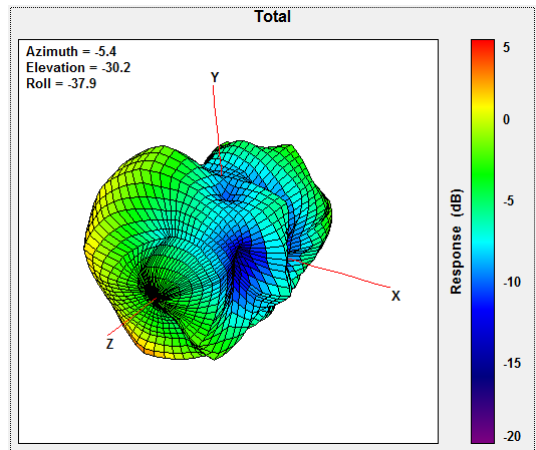

2170MHz

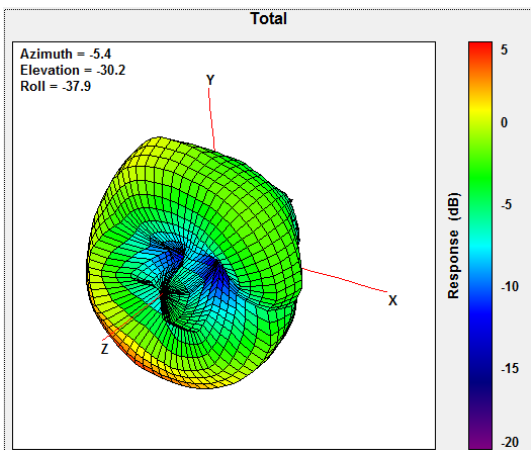

2500MHz

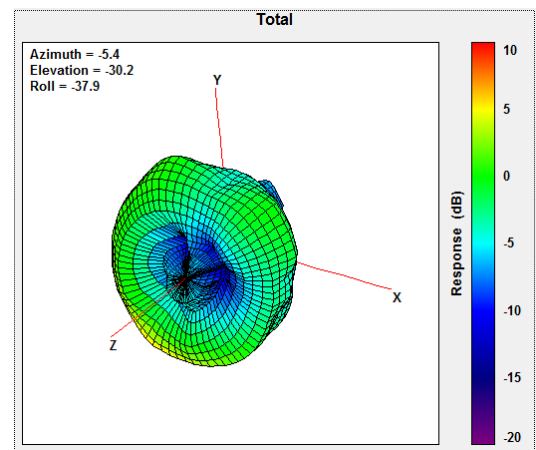

2690MHz

### 3.2.17. 2D Radiation Pattern (Wi-Fi MIMO1 with 0.3M cable length)

#### XY Plane

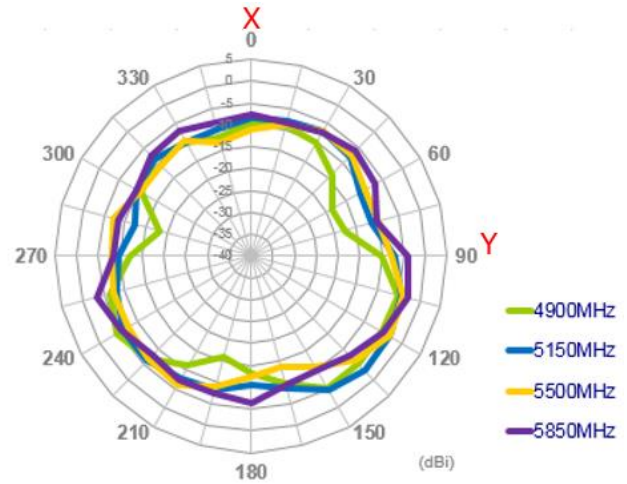
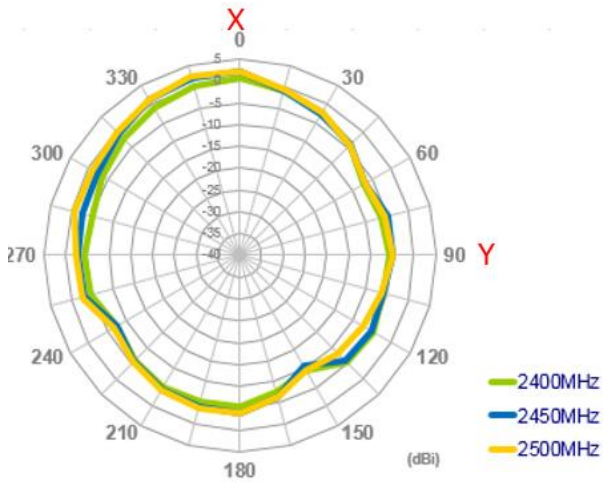

#### XZ Plane

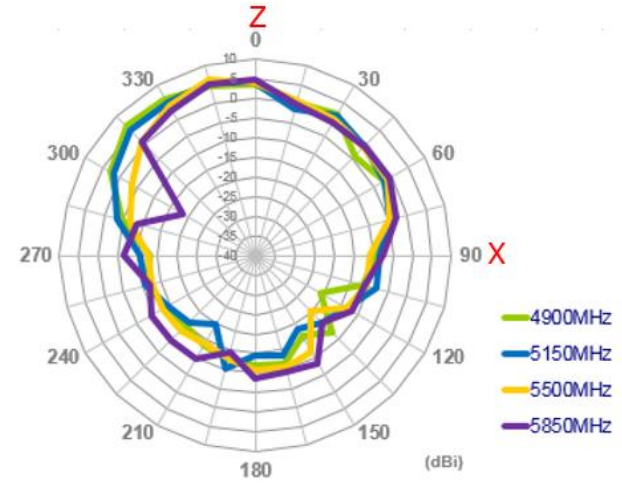
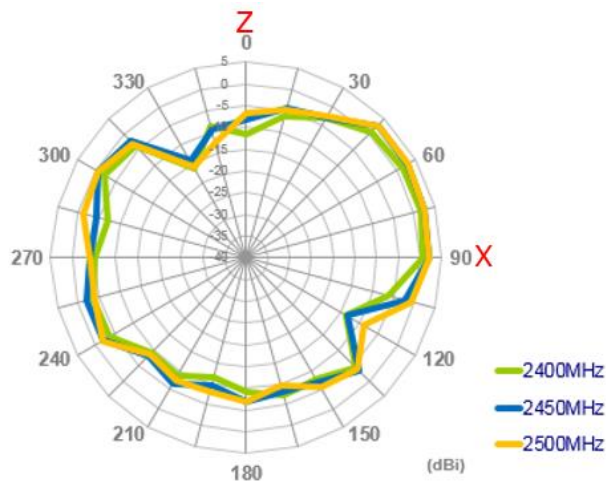

#### YZ Plane

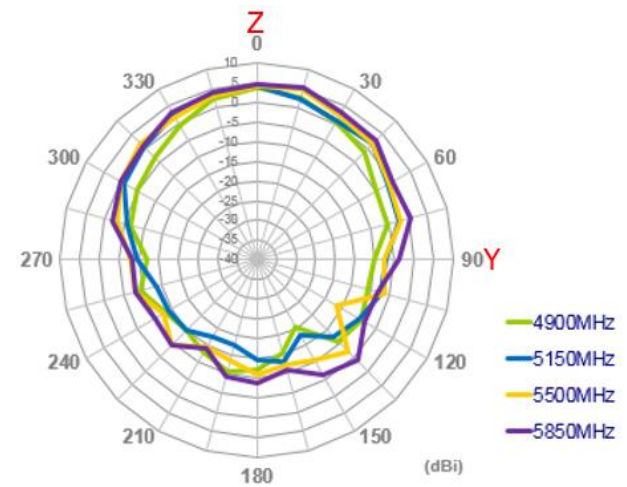
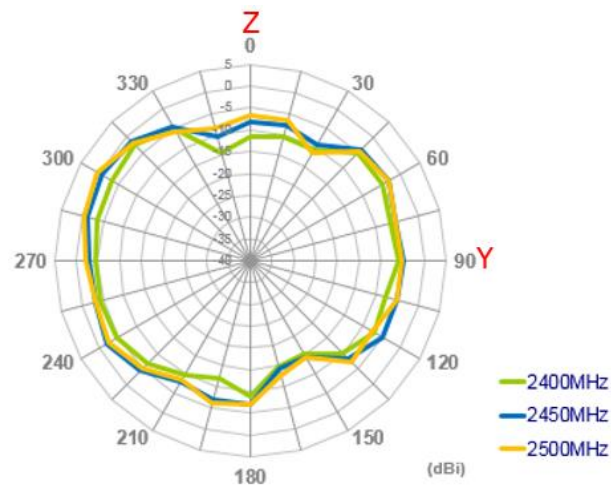



3.2.18. 3D Radiation Pattern (Wi-Fi MIMO1 with 0.3M cable length on the 30\*30cm ground plane)

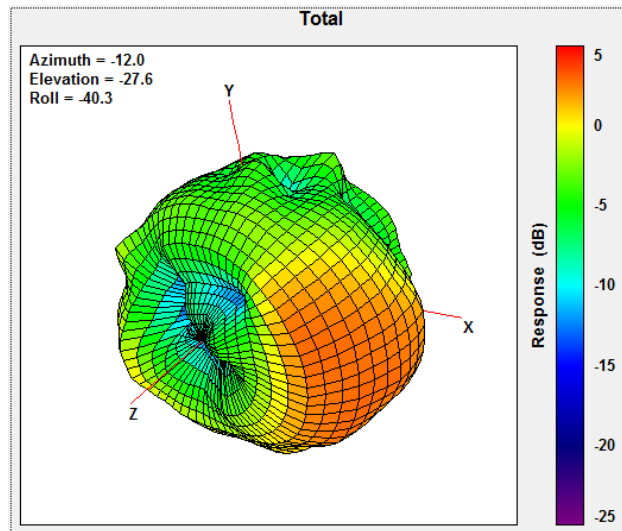

2450MHz

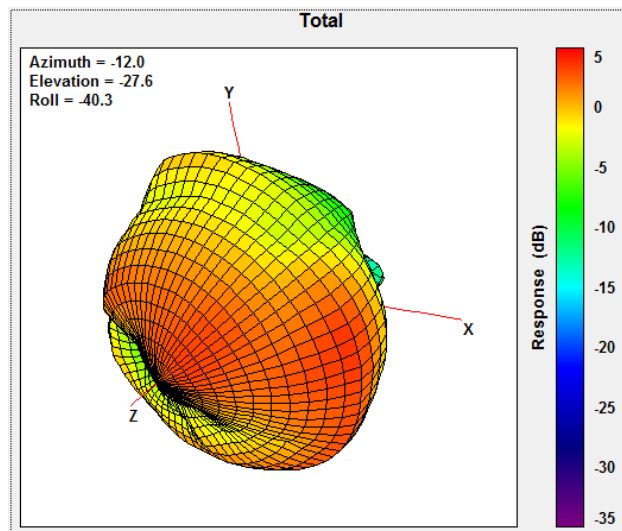

5500MHz

### 3.2.19. 2D Radiation Pattern (Wi-Fi\_MIMO2 with 0.3M cable length)

#### XY Plane

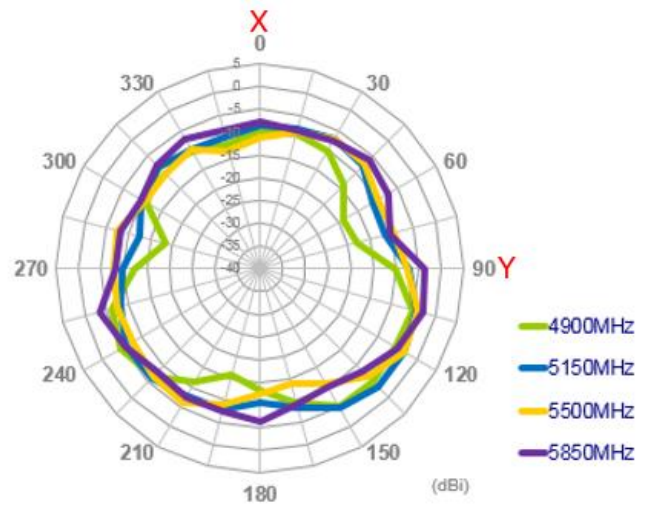
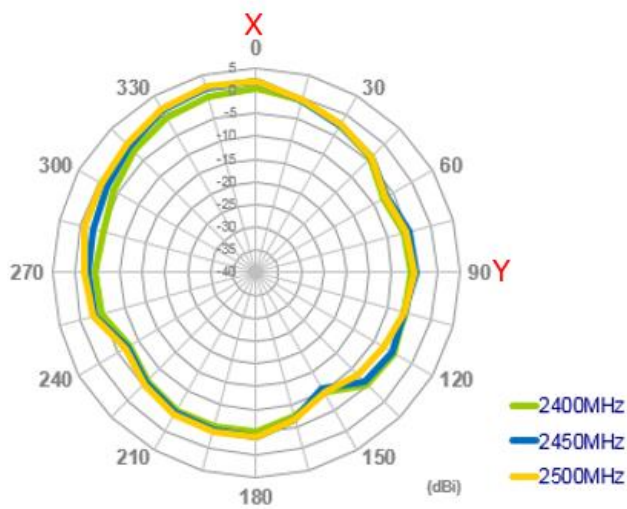

#### XZ Plane

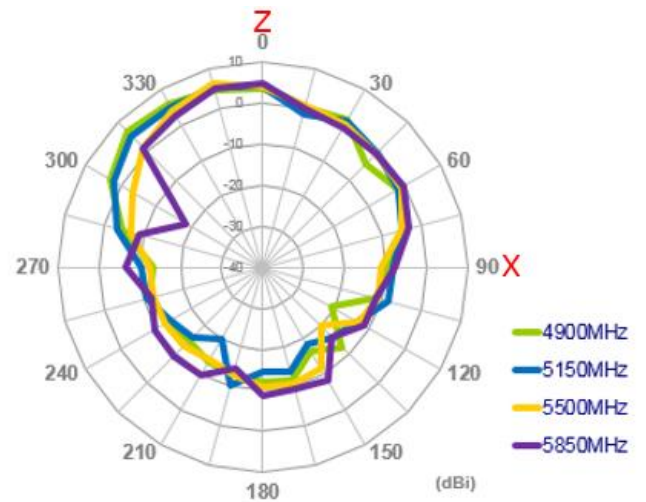
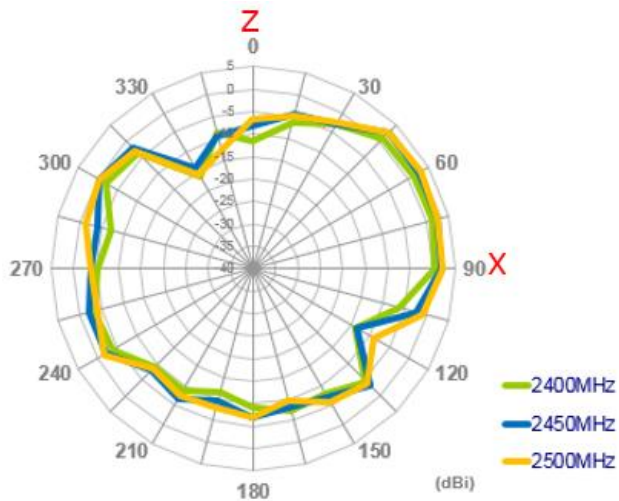

#### YZ Plane

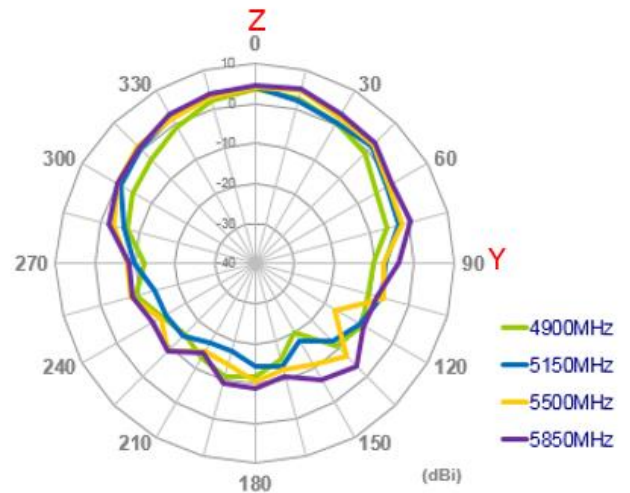
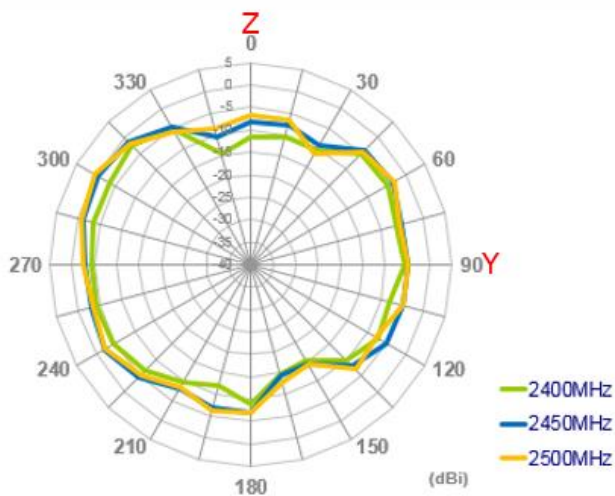

3.2.20. 3D Radiation Pattern (Wi-Fi MIMO2 with 0.3M cable length on the 30\*30cm ground plane)

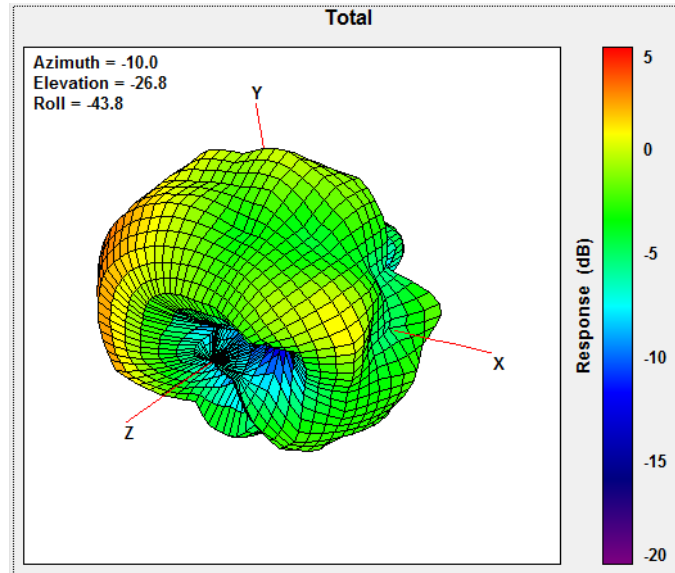

2450MHz

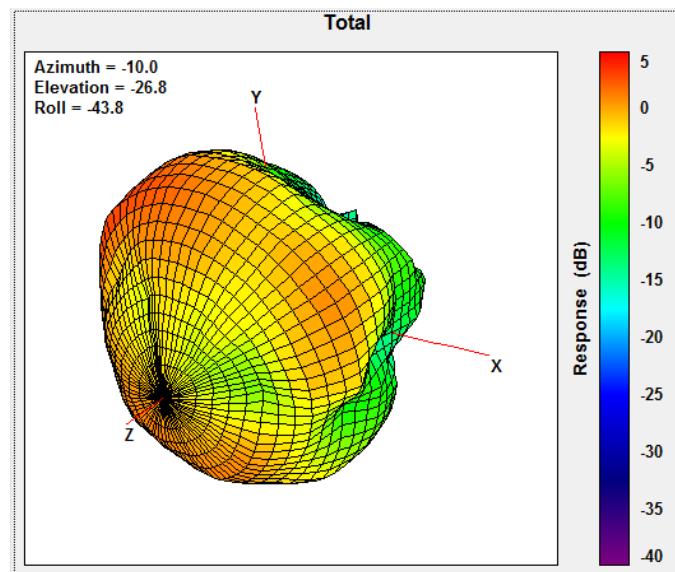

5500MHz



## 5. Installation

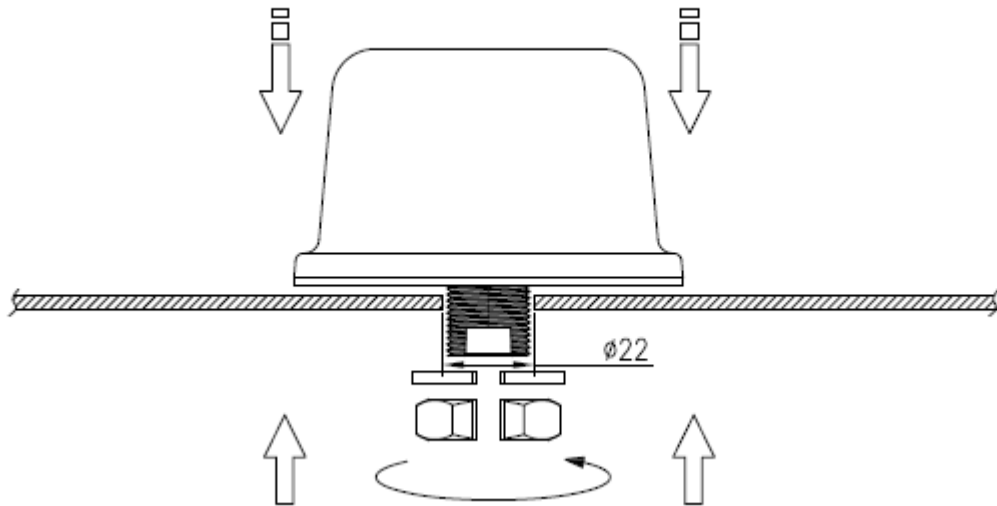

Recommended torque for mounting is 29.4N•m

Maximum torque for mounting is 39.2 N•m

## 6. Packaging

### Packaging Specifications

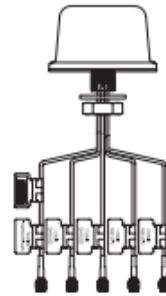

20 pcs MA850.A.LBICG.001 per layer  
2 Layers per carton

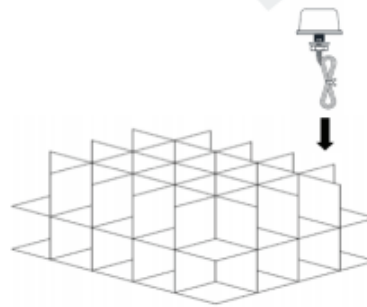

40 pcs MA850.A.LBICG.001 per carton  
Carton - 532 x 429 x 200mm  
Weight - 14Kg

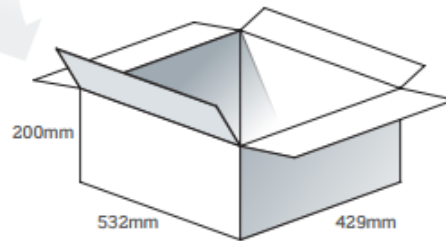

Pallet Dimensions 1200 x 1000 x 1390mm  
24 Cartons per Pallet  
6 Cartons per layer  
4 Layers

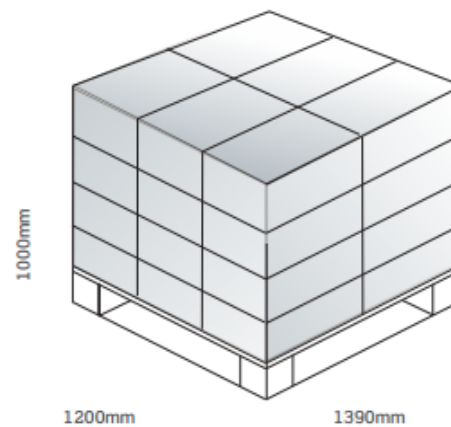

## 7. Application Note

The MA850 antenna performance with different cable lengths is shown below.

### 7.1. In free space (LTE MIMO Antenna)

#### 7.1.1. Return Loss (LTE MIMO 1)

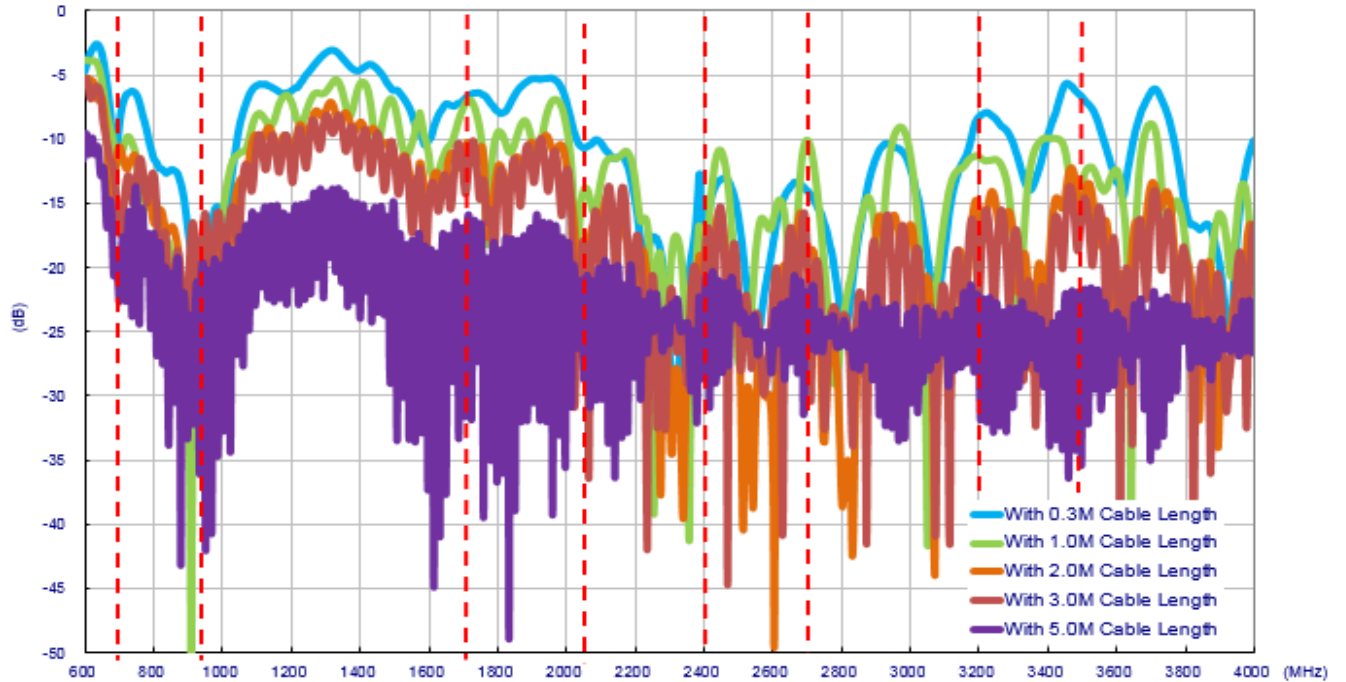

#### 7.1.2. Return Loss (LTE MIMO 2)

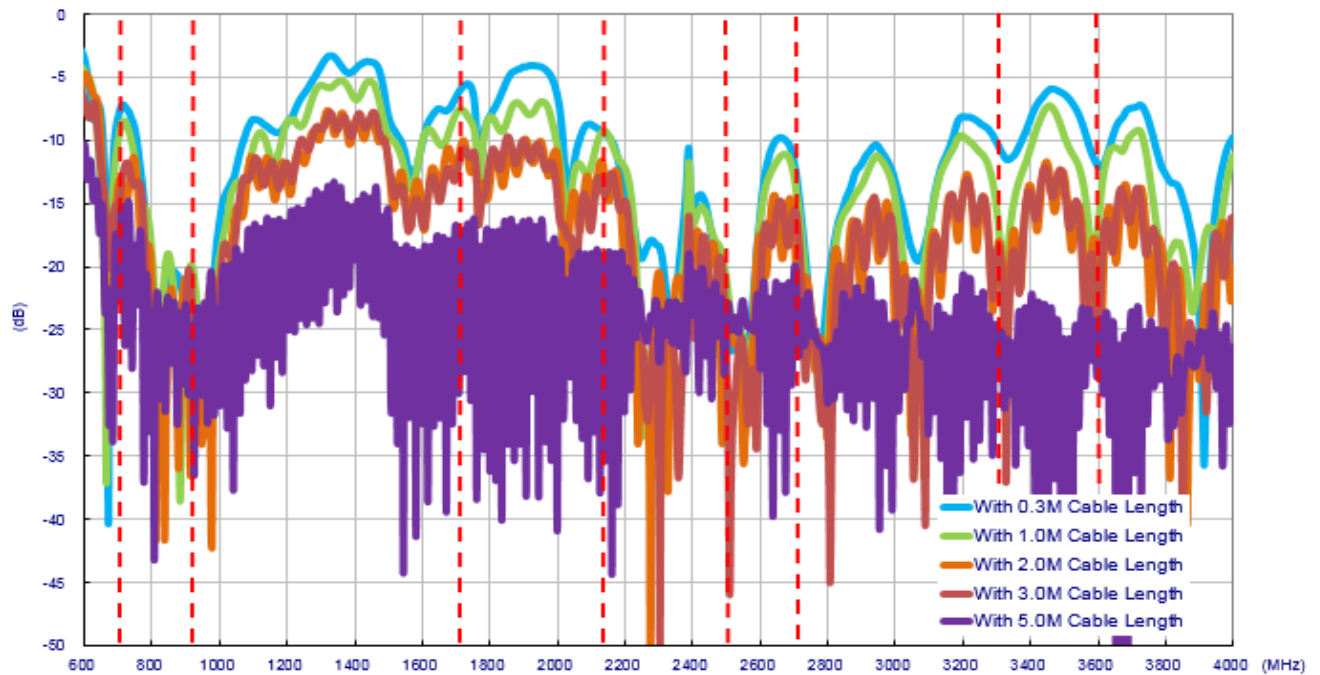

### 7.1.3. LTE Isolation

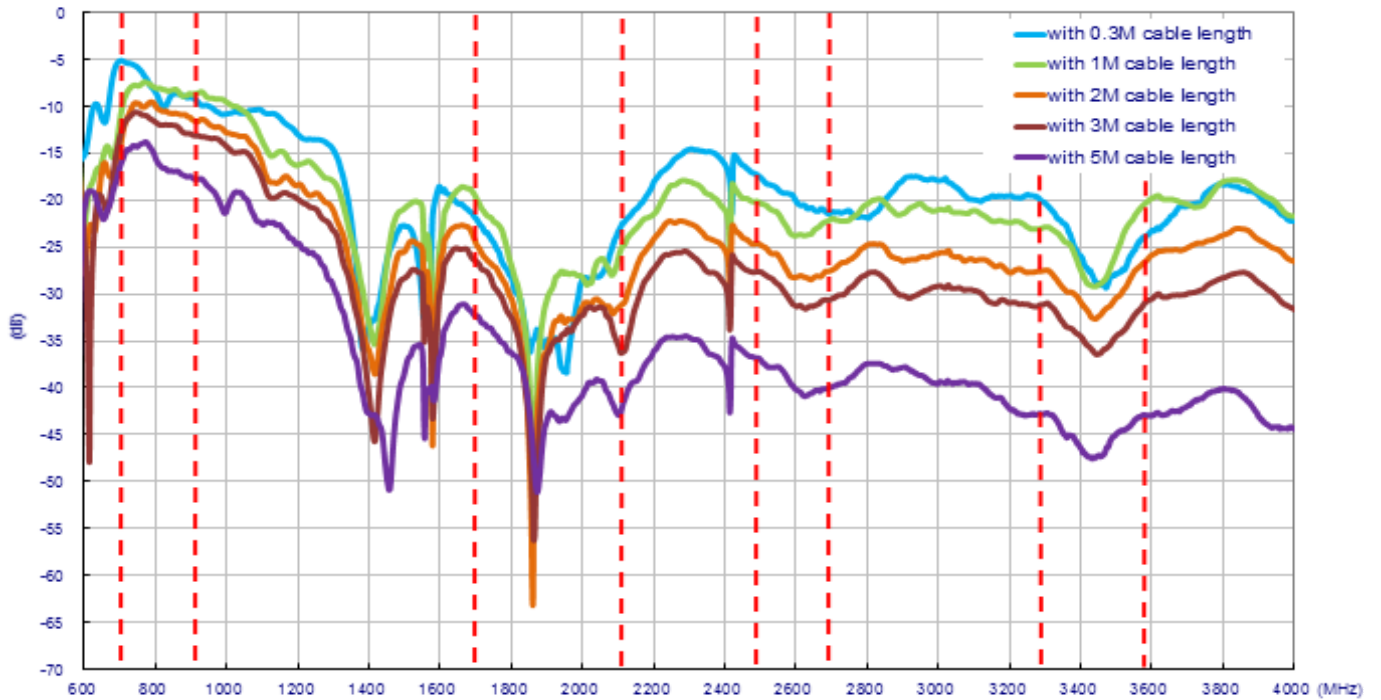

### 7.1.4. Efficiency (LTE MIMO 1)

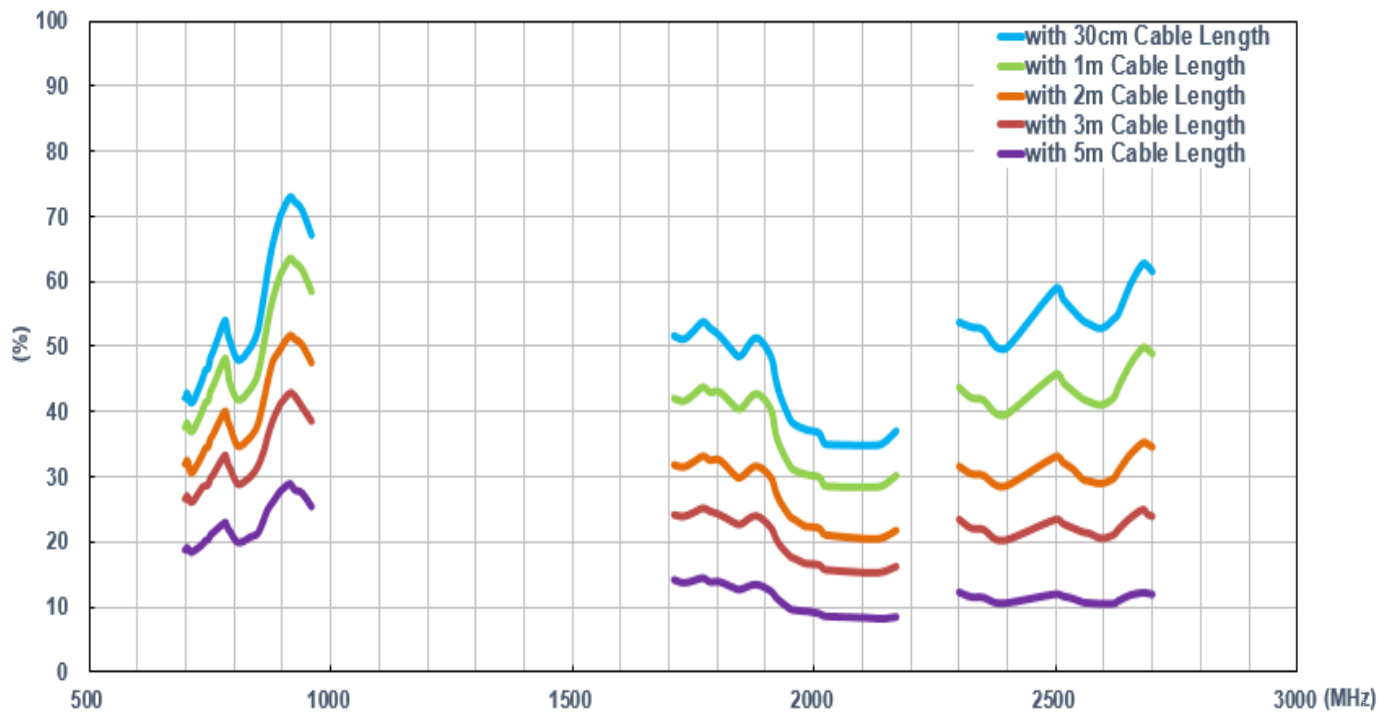



### 7.1.5. Efficiency (LTE MIMO 2)

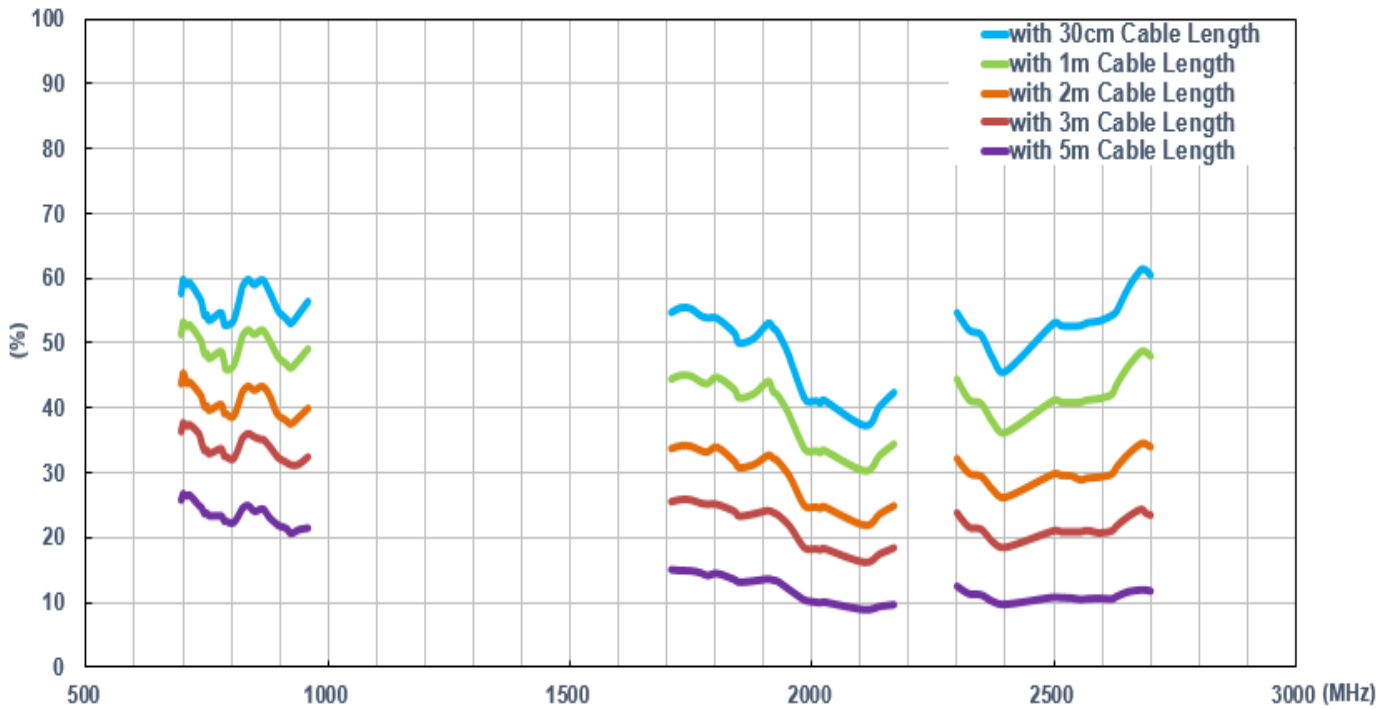

### 7.1.6. Average Gain (LTE MIMO 1)

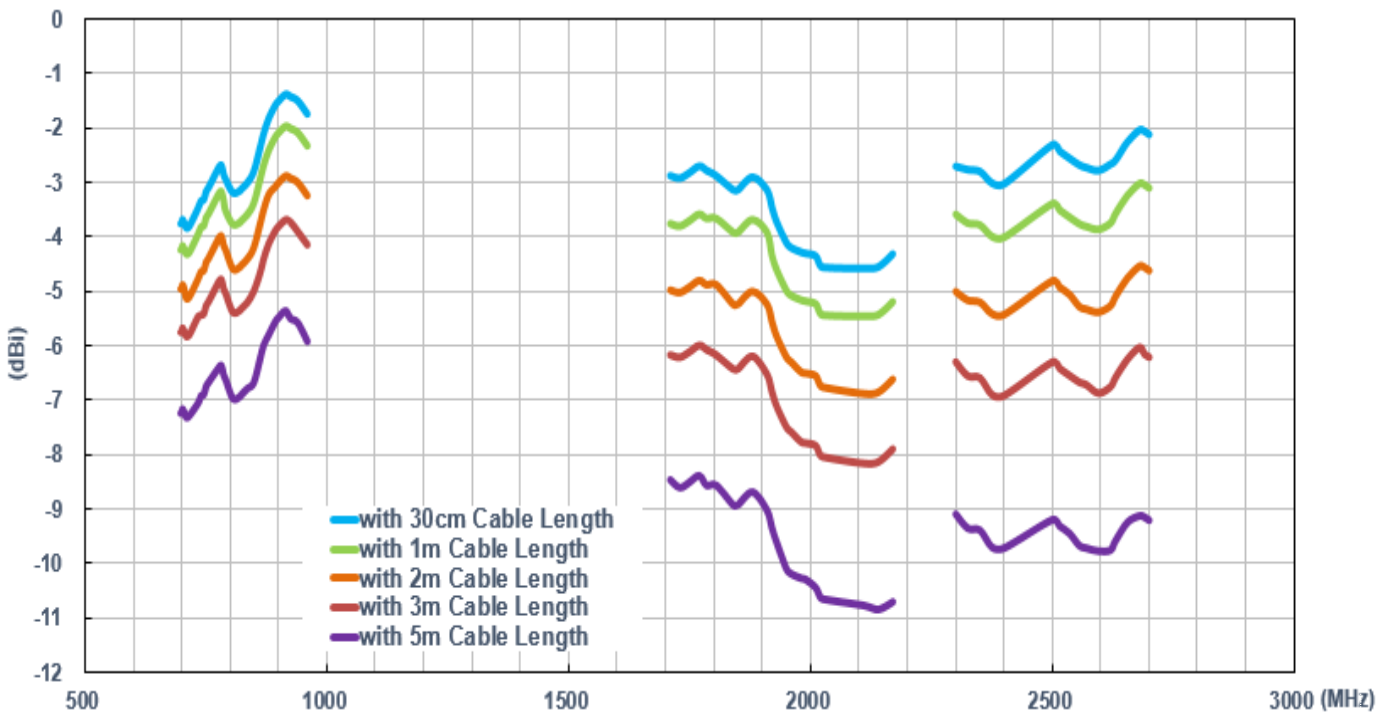

### 7.1.7. Average Gain (LTE MIMO 2)

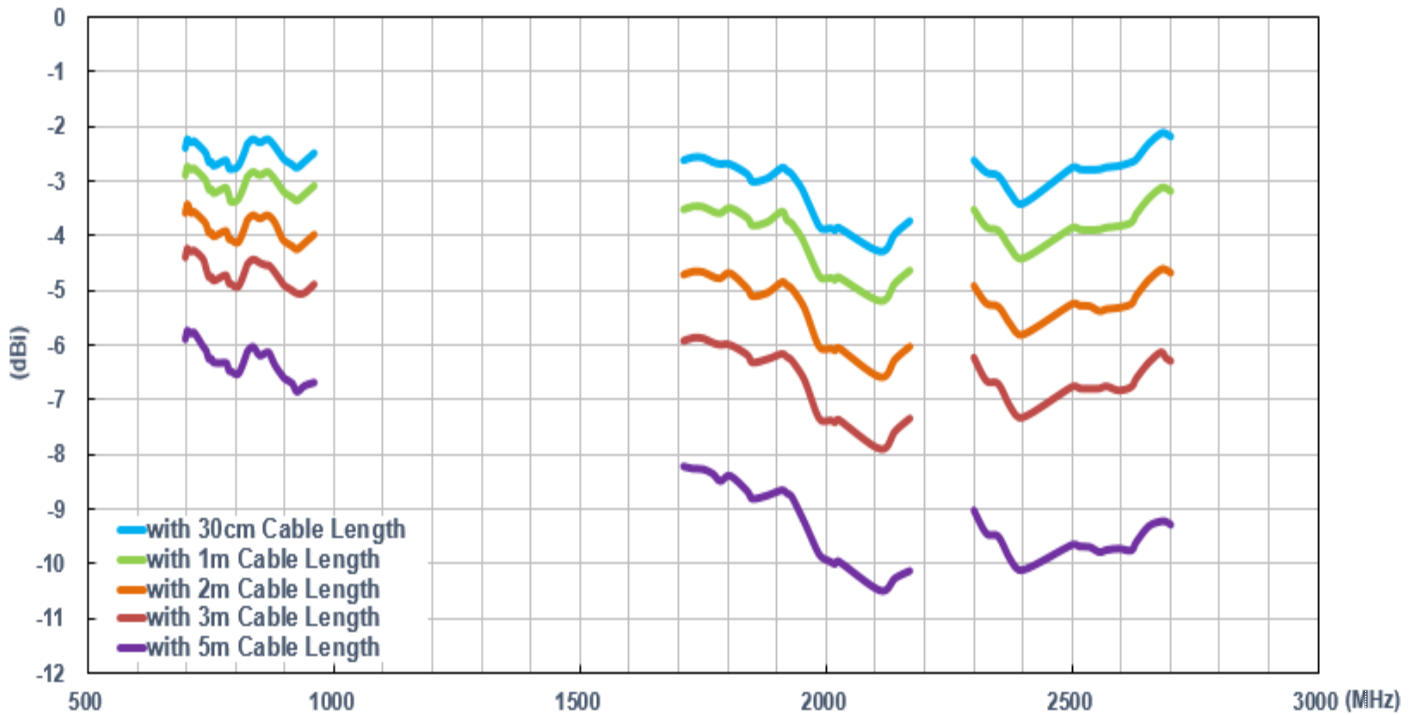

### 7.1.8. Peak Gain (LTE MIMO 1)

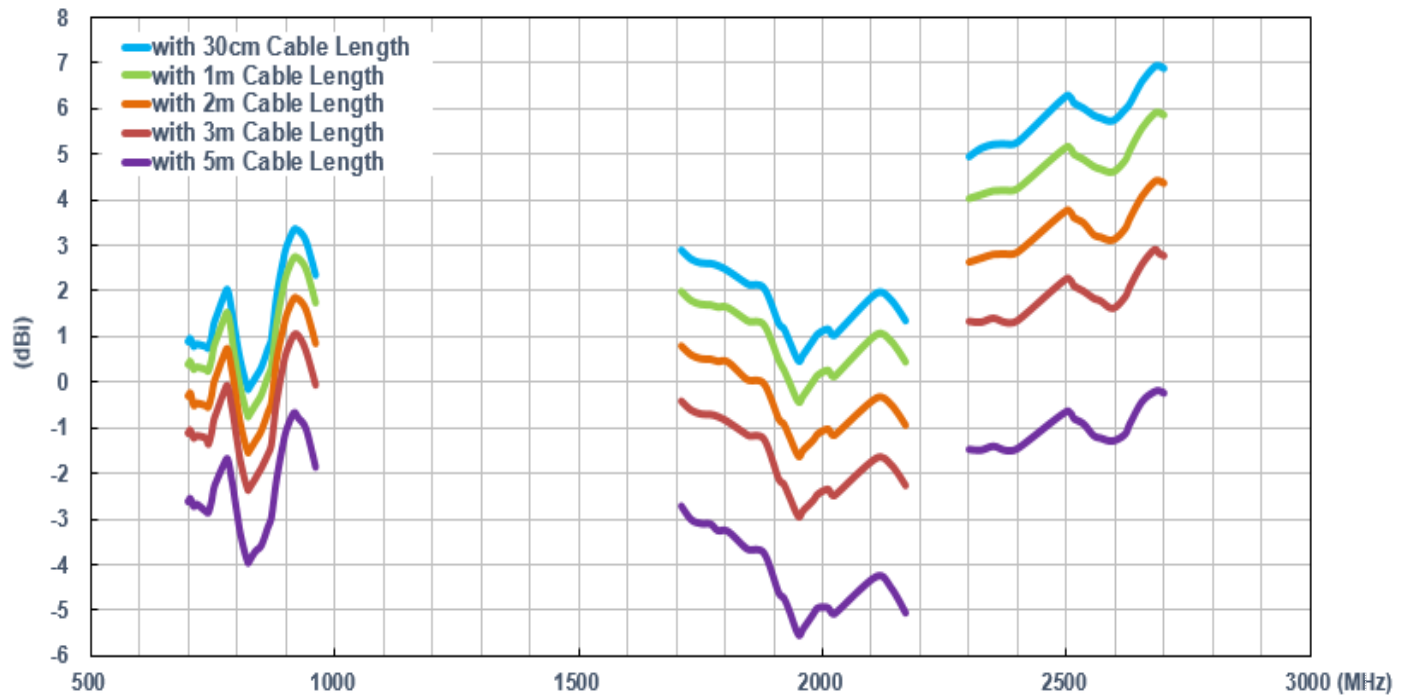

### 7.1.9. Peak Gain (LTE MIMO 2)

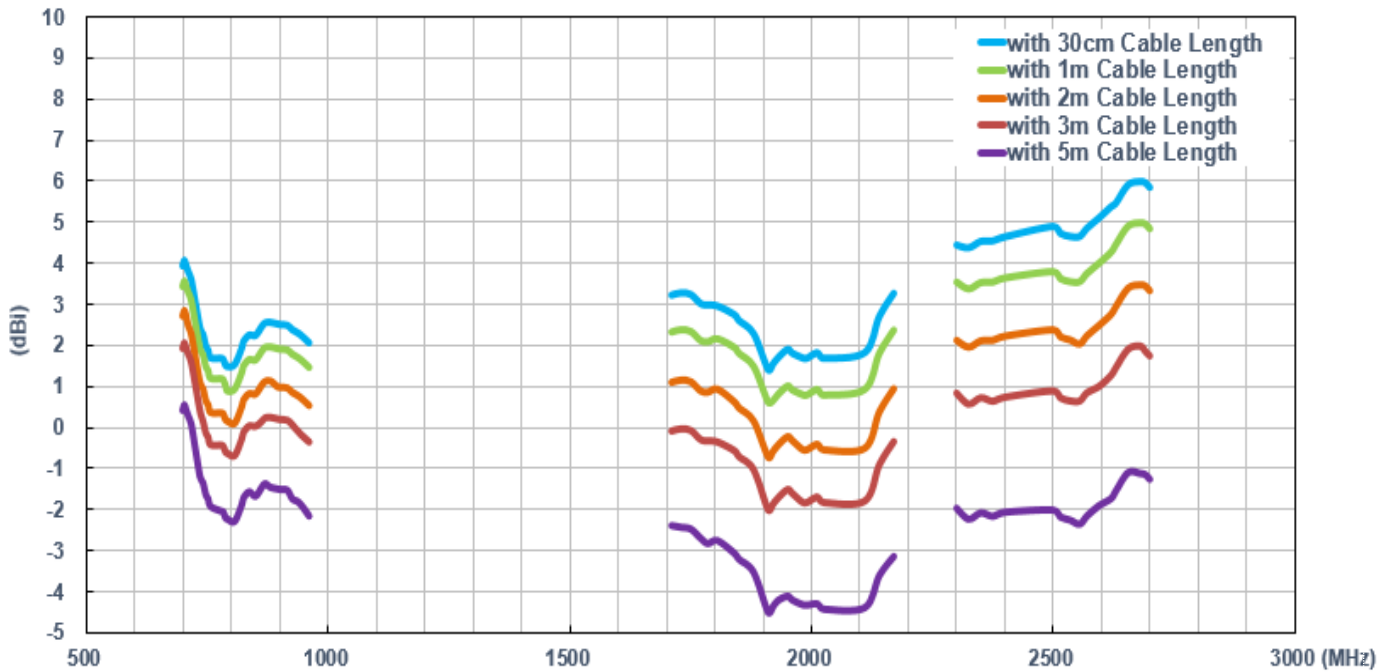

## 7.2. In free space (Wi-Fi MIMO Antenna)

### 7.2.1. Return Loss (Wi-Fi MIMO 1)

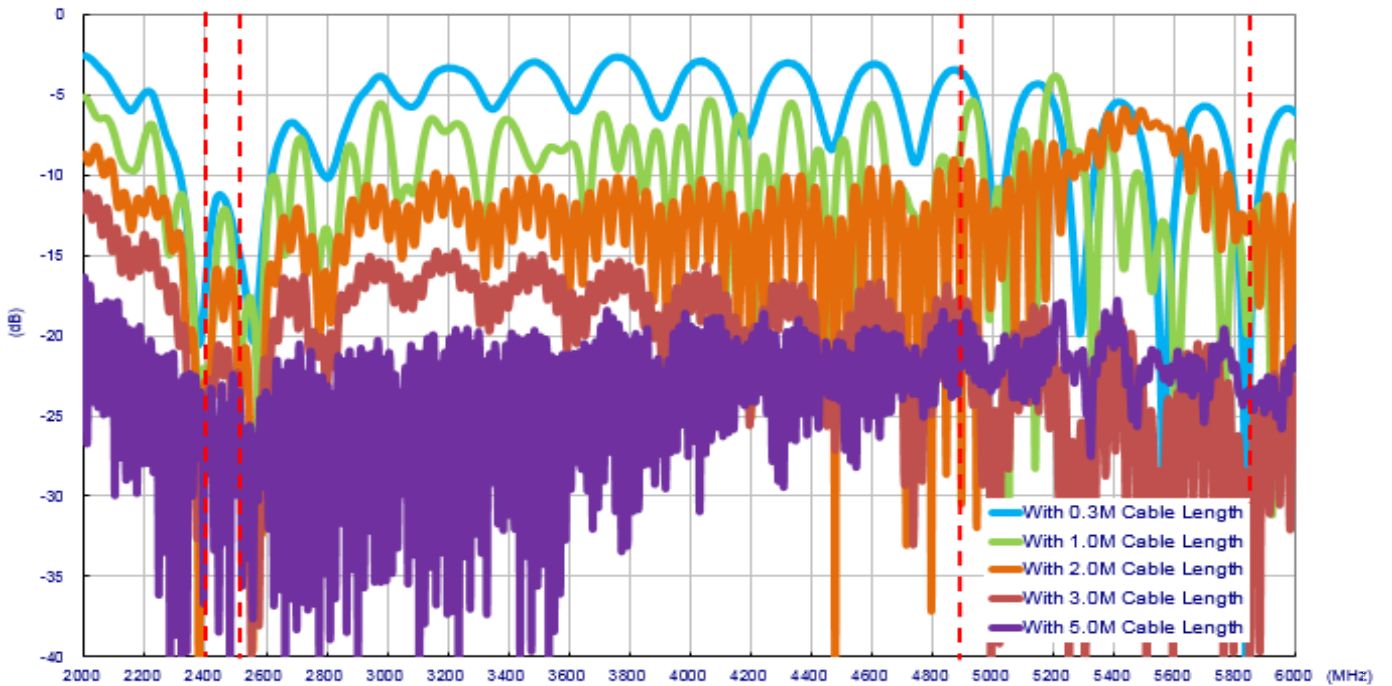

### 7.2.2. Return Loss (Wi-Fi MIMO 2)

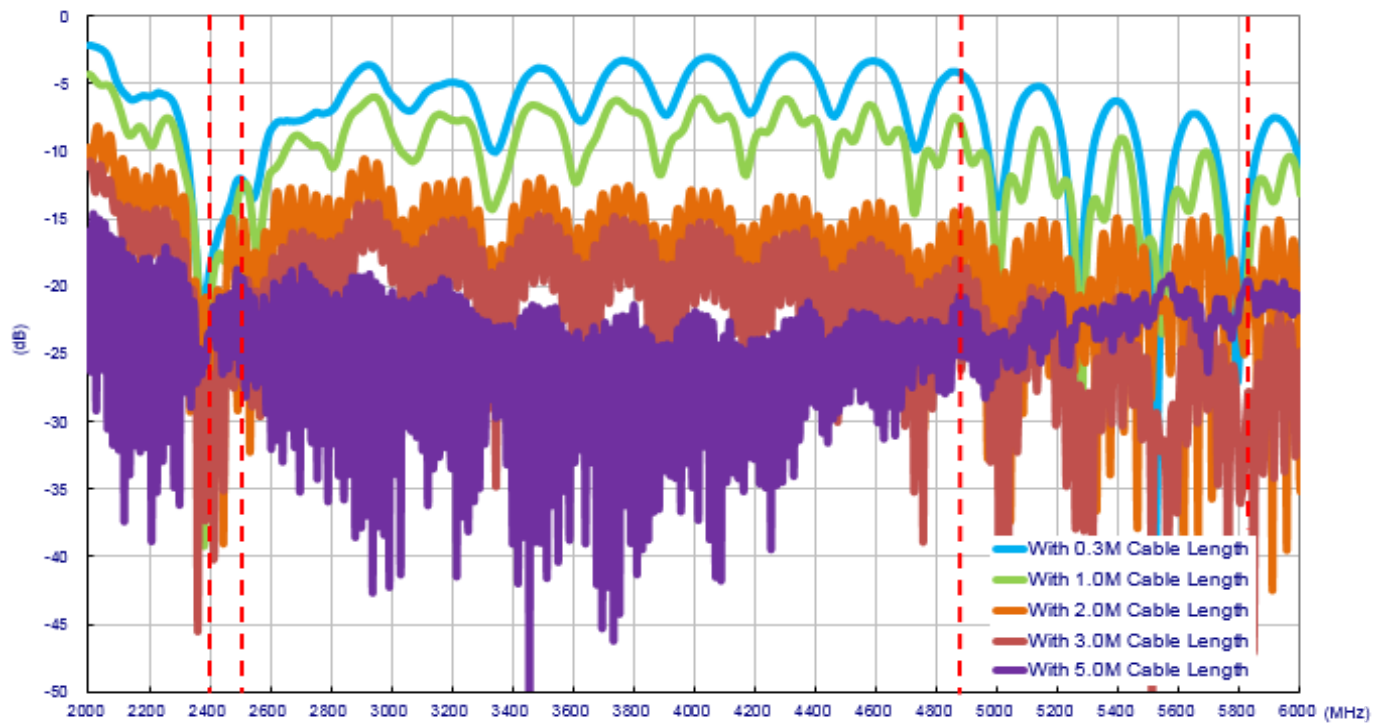

### 7.2.3. Wi-Fi Isolation

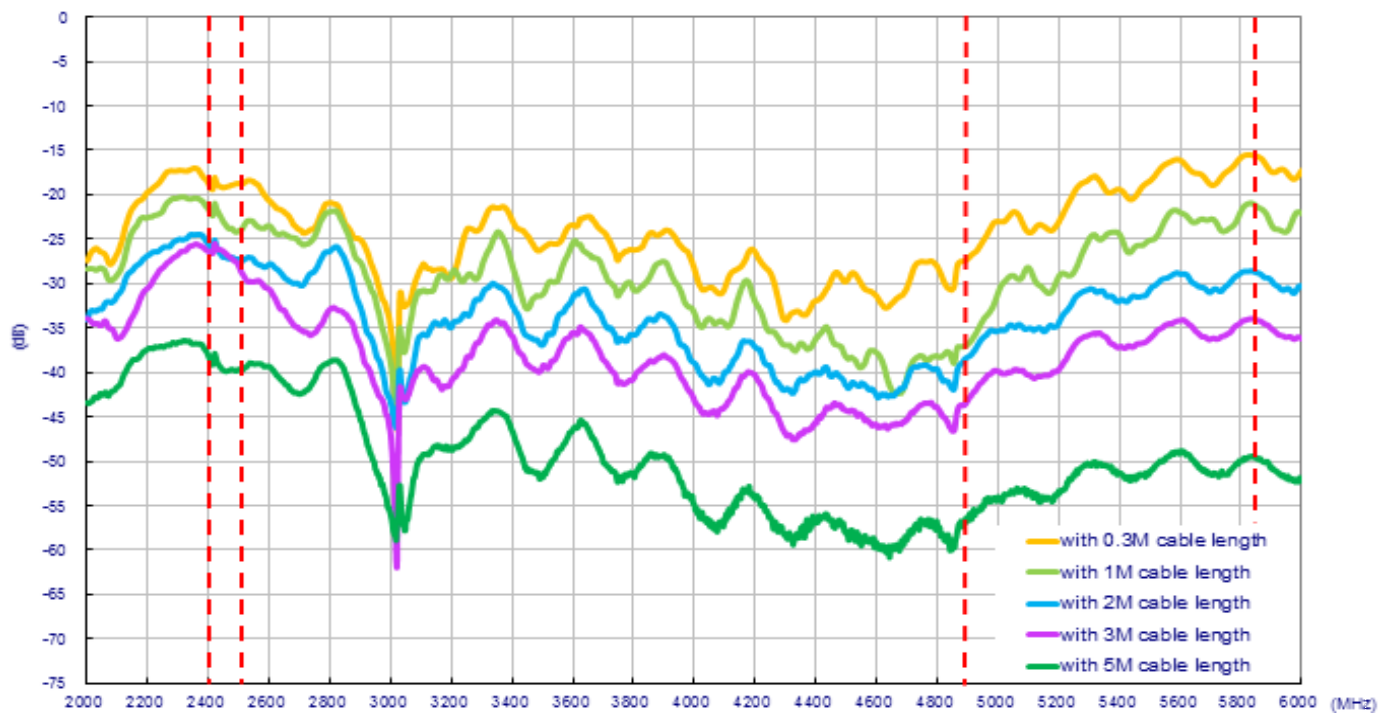

### 7.2.4. Efficiency (Wi-Fi MIMO 1)

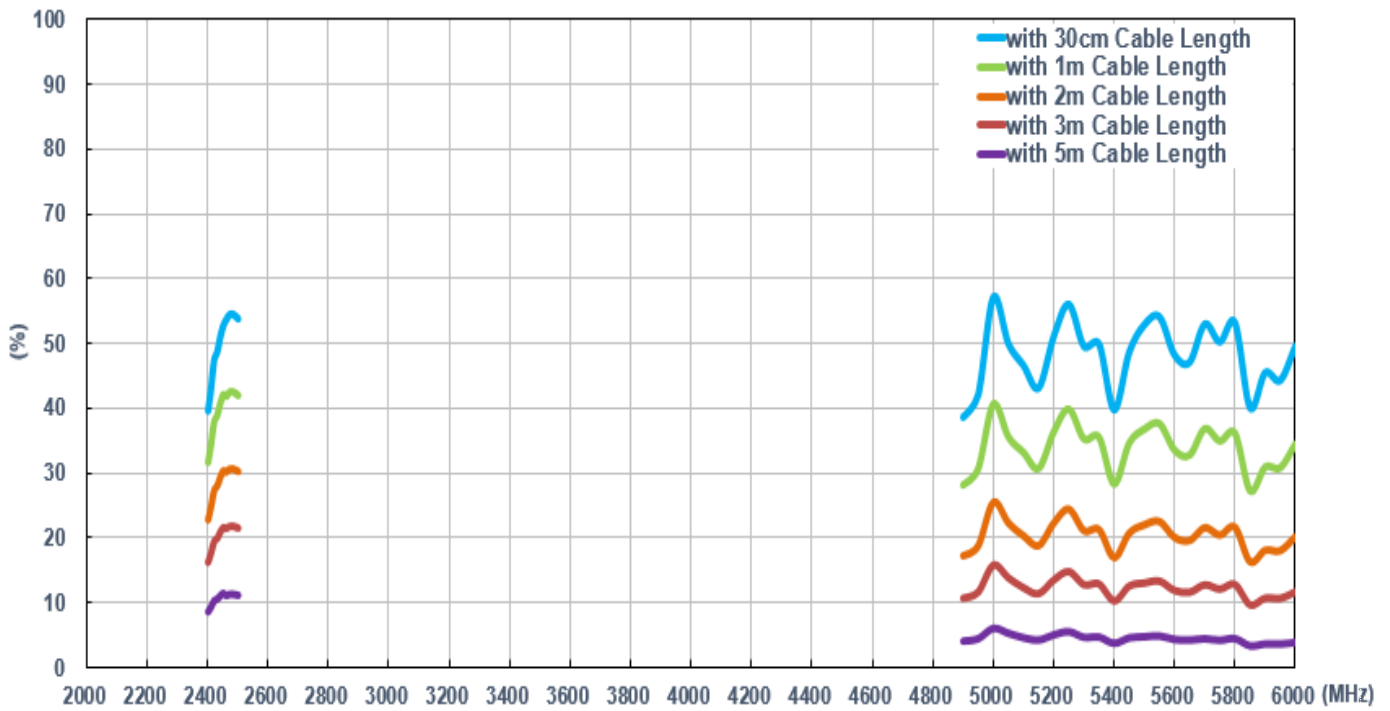

### 7.2.5. Efficiency (Wi-Fi MIMO 2)

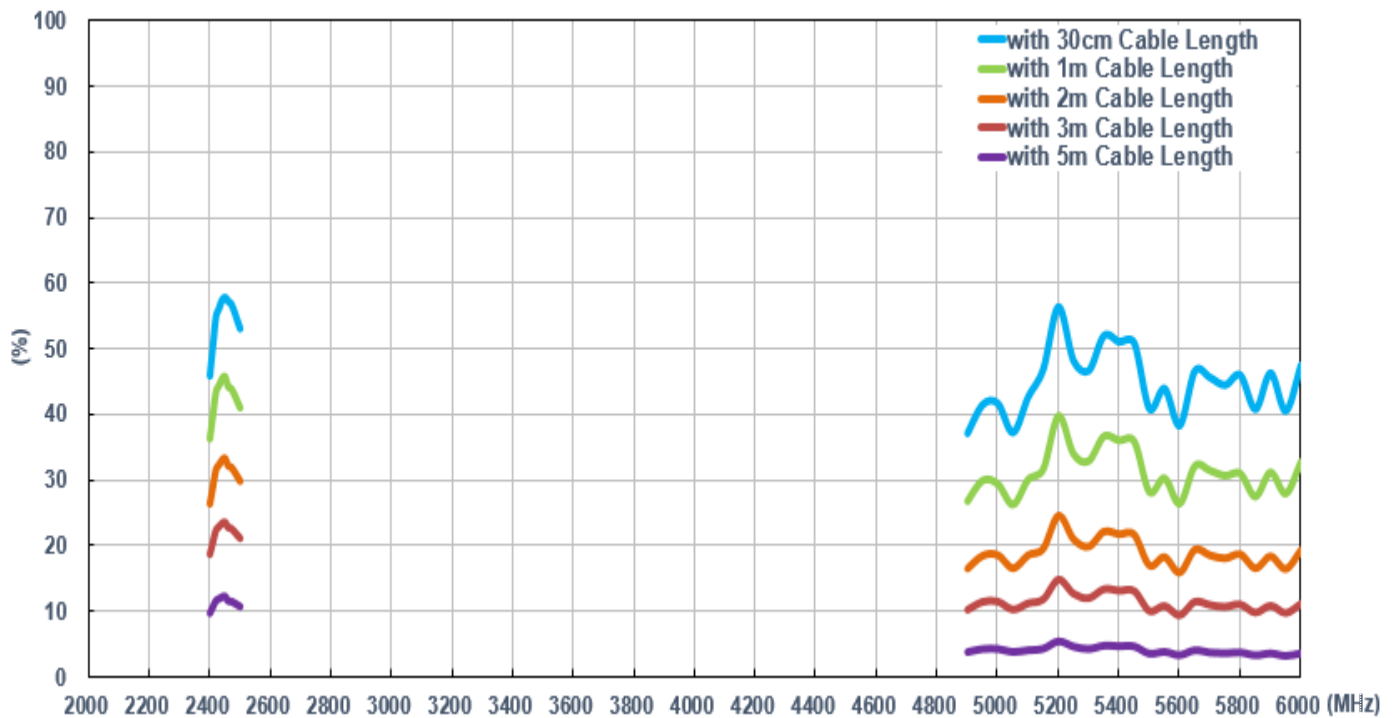

### 7.2.6. Average Gain (Wi-Fi MIMO 1)

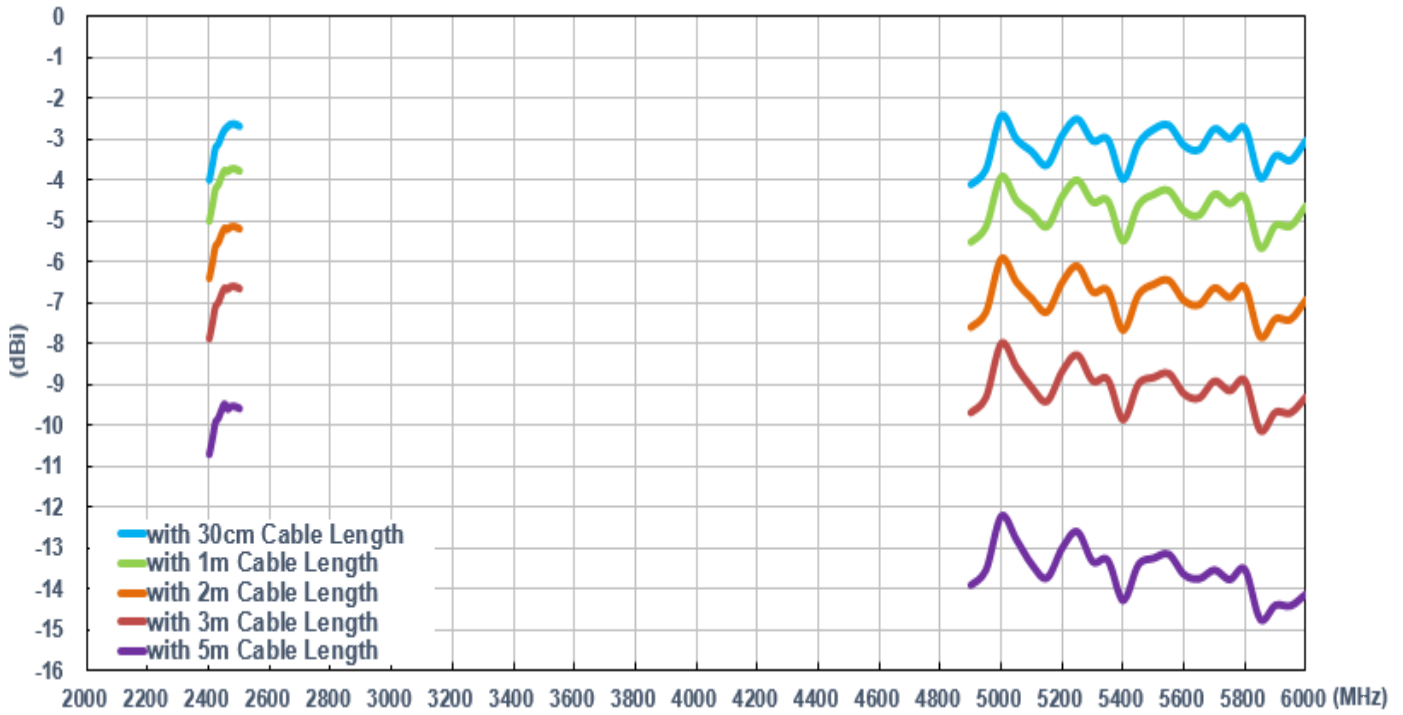

### 7.2.7. Average Gain (Wi-Fi MIMO 2)

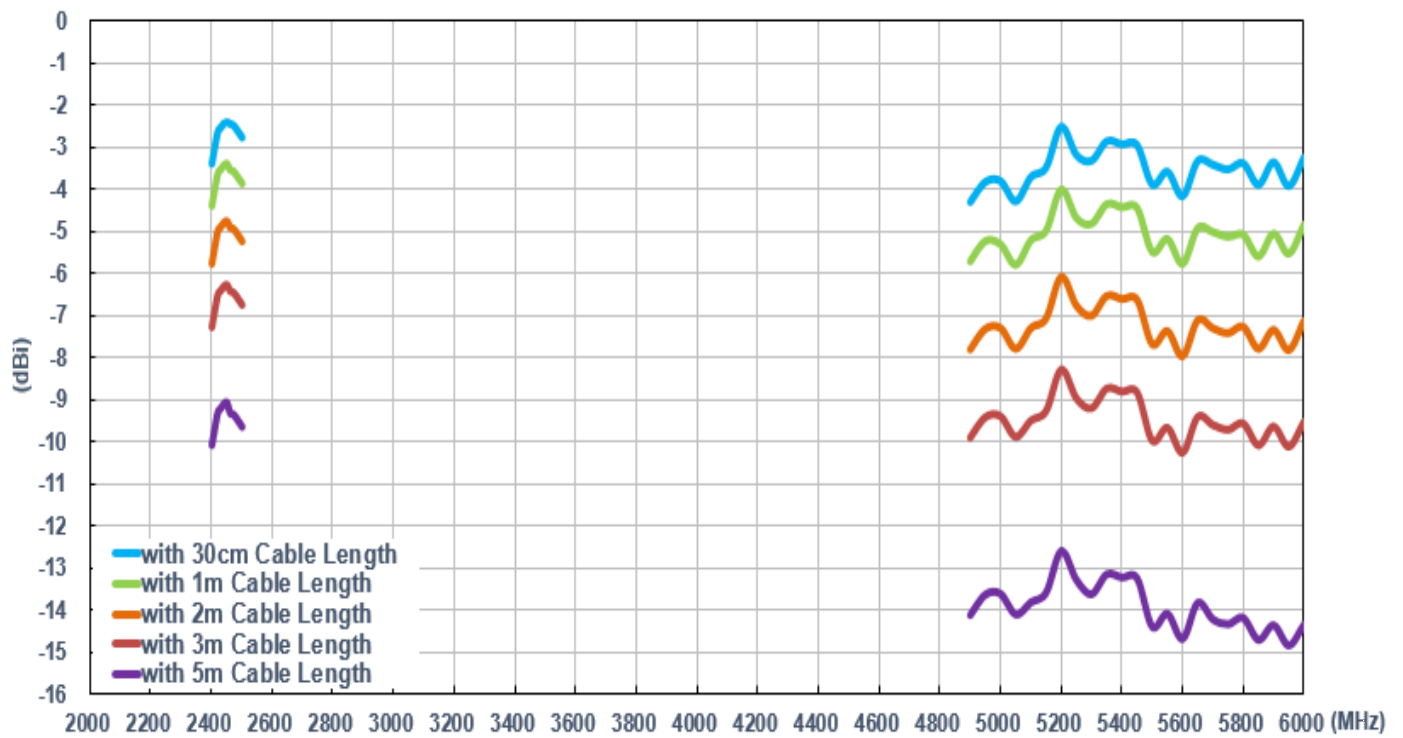

### 7.2.8. Peak Gain (Wi-Fi MIMO 1)

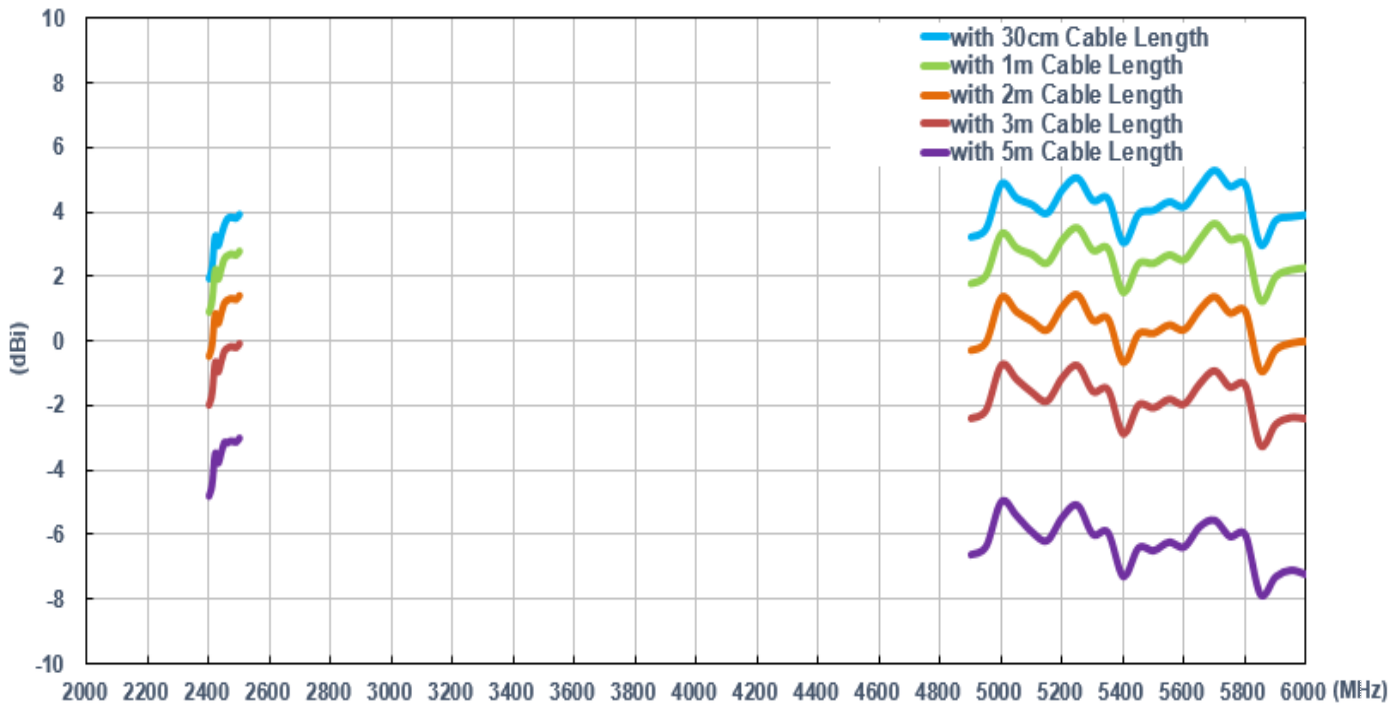

### 7.2.9. Peak Gain (Wi-Fi MIMO 2)

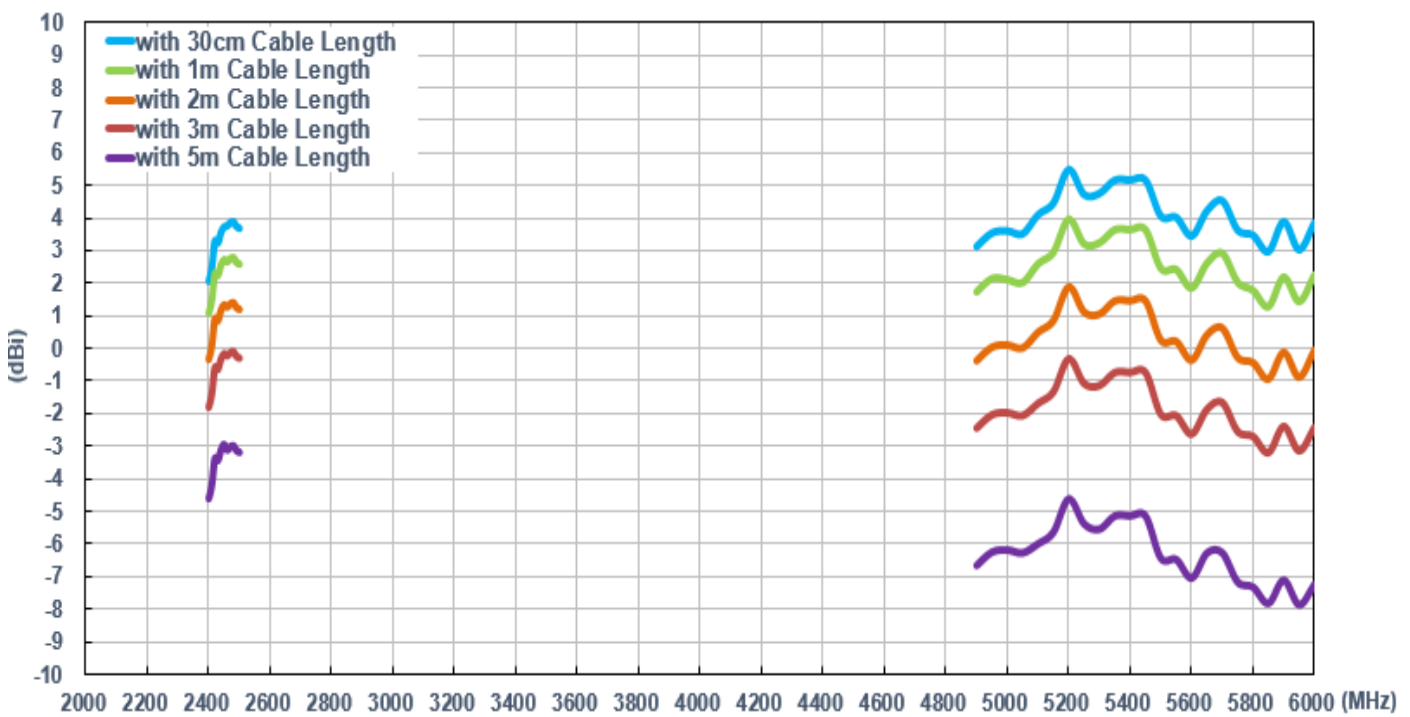

Taoglas makes no warranties based on the accuracy or completeness of the contents of this document and reserves the right to make changes to specifications and product descriptions at any time without notice. Taoglas reserves all rights to this document and the information contained herein.

Reproduction, use or disclosure to third parties without express permission is strictly prohibited.

Copyright © Taoglas Ltd.