

SPECIFICATION

- Part No. : **GP.1575.35.3.A.02**
- Product Name : 3.5mm thick GPS Patch Antenna, 1575MHz
- Features : 35mm*35mm*3.5mm
ROHS Compliant



1. Introduction

This 35*35mm ceramic GPS/GALILEO patch antenna is based on smart *XtremeGain*™ technology. It is mounted via pin and double-sided adhesive and has been tuned as the optimal solution for the customer device environment.

2. Key Antenna Performance Indicators

Original Patch Specification tested on 50*50mm ground plane

No	Parameter	Specification
1	Center Frequency	1575MHz ± 6MHz
2	Bandwidth	22MHz min
3	VSWR	1.5 max
4	Gain at Zenith	2.0 dBic typ.
5	Gain at 10°elevation	1.5dBic typ.
6	Axial Ratio	3 dB max
7	Polarization	RHCP
8	Impedance	50 Ohms
9	Frequency Temperature Coefficient (τ_f)	0 ± 20ppm / °C
10	Operating Temperature	-40°C to +85°C

3. Test Setup

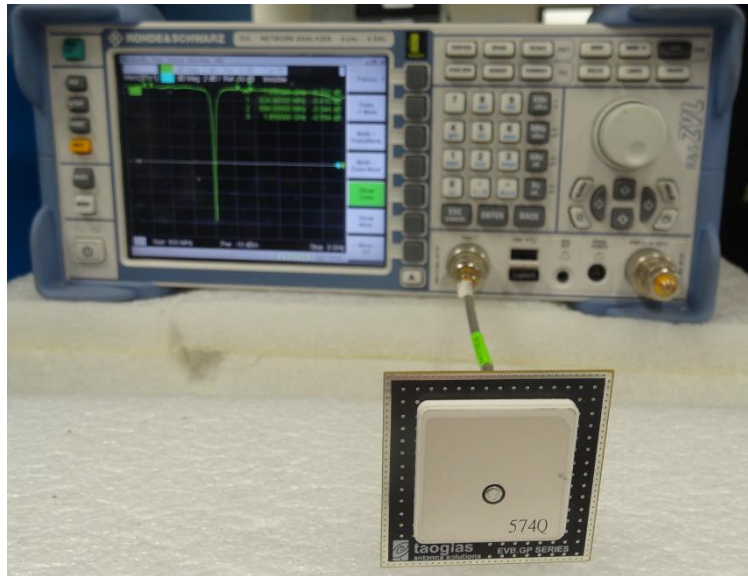

Figure 1. Return Loss measurement.

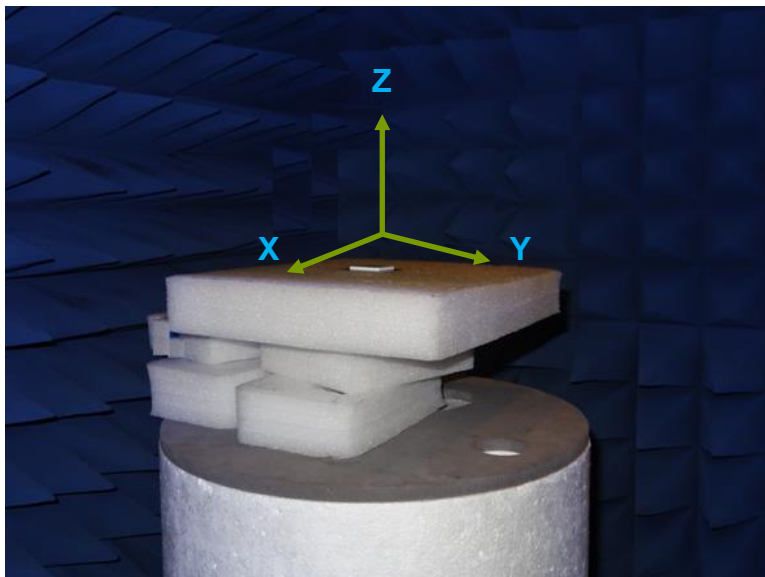

Figure 2. Peak gain, average gain, efficiency and radiation pattern measurements.

4. Antenna Parameters

4.1. Return Loss

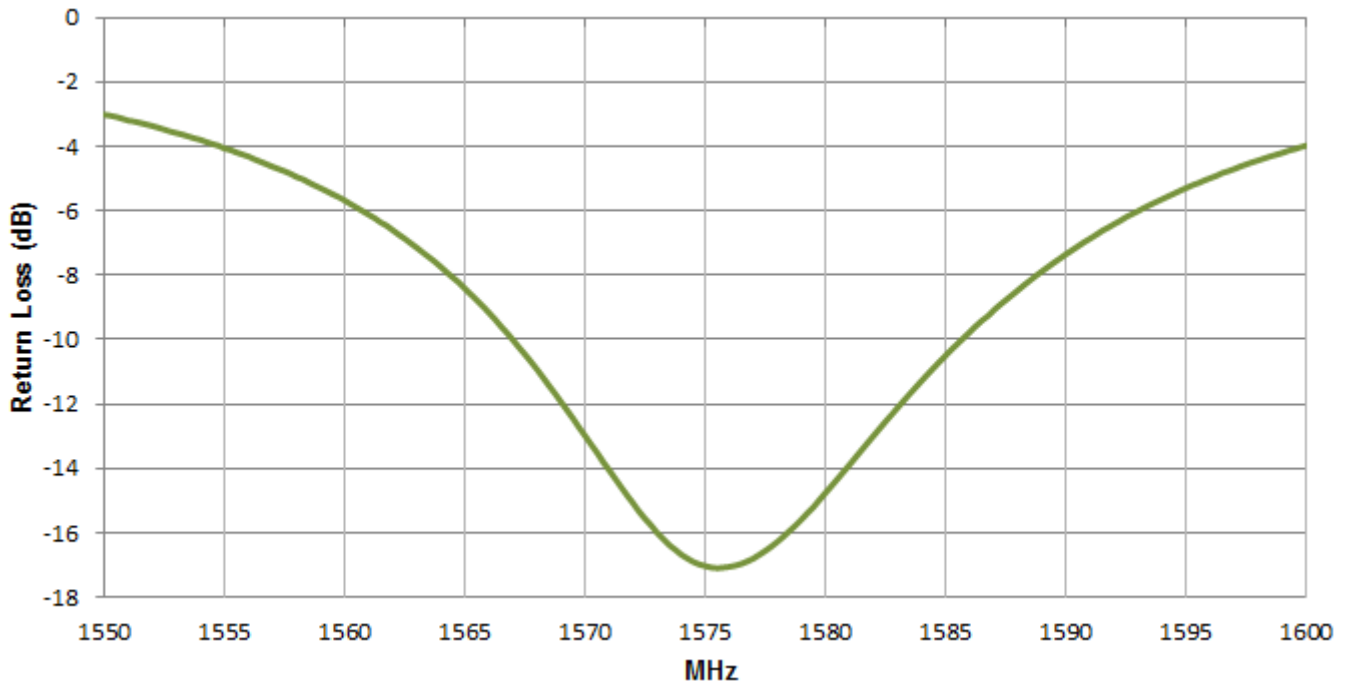

Figure 3. Return Loss of the GP.1575.35.A.02

4.2. VSWR

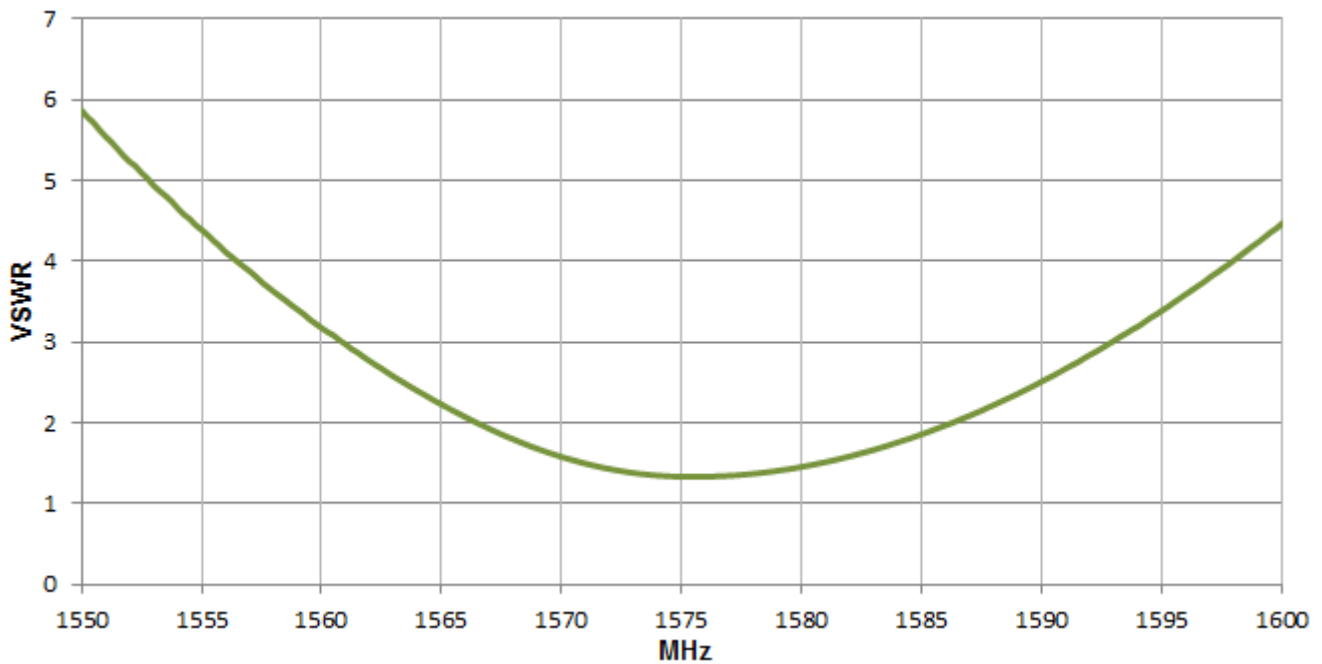

Figure 4. VSWR of the GP.1575.35.A.02

4.3. Efficiency

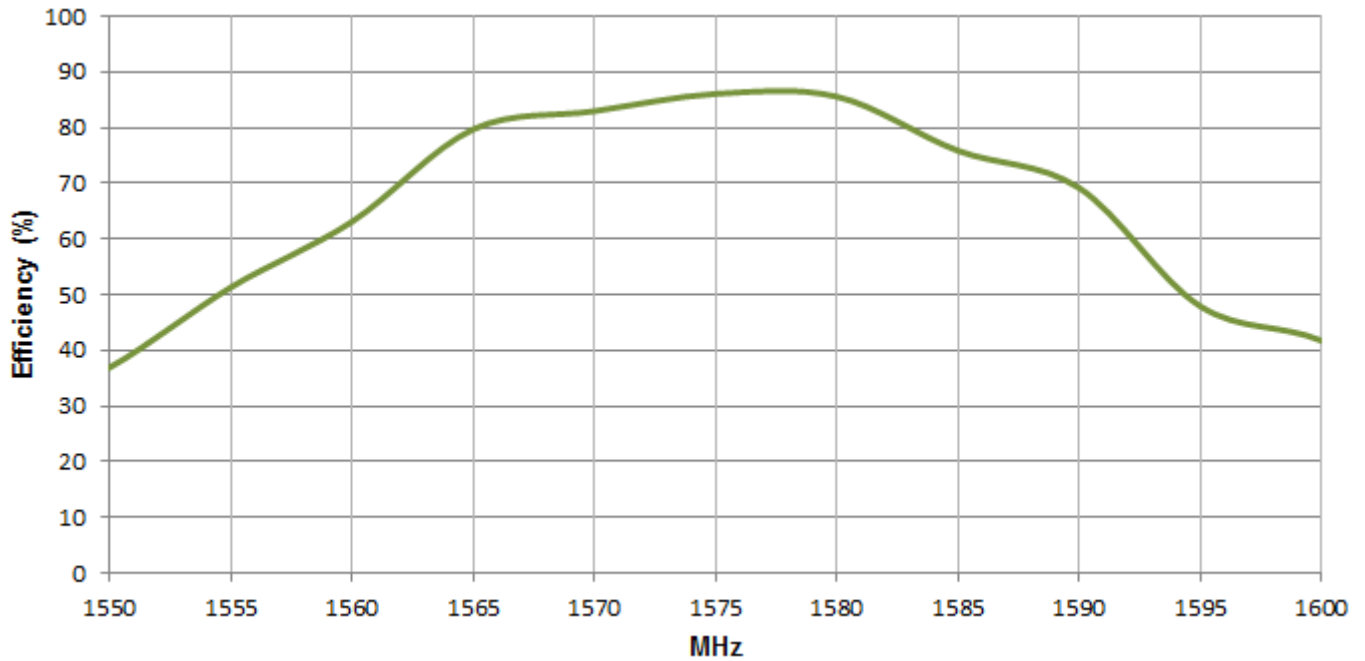

Figure 5. Efficiency of the GP.1575.35.A.02

4.4. Peak Gain

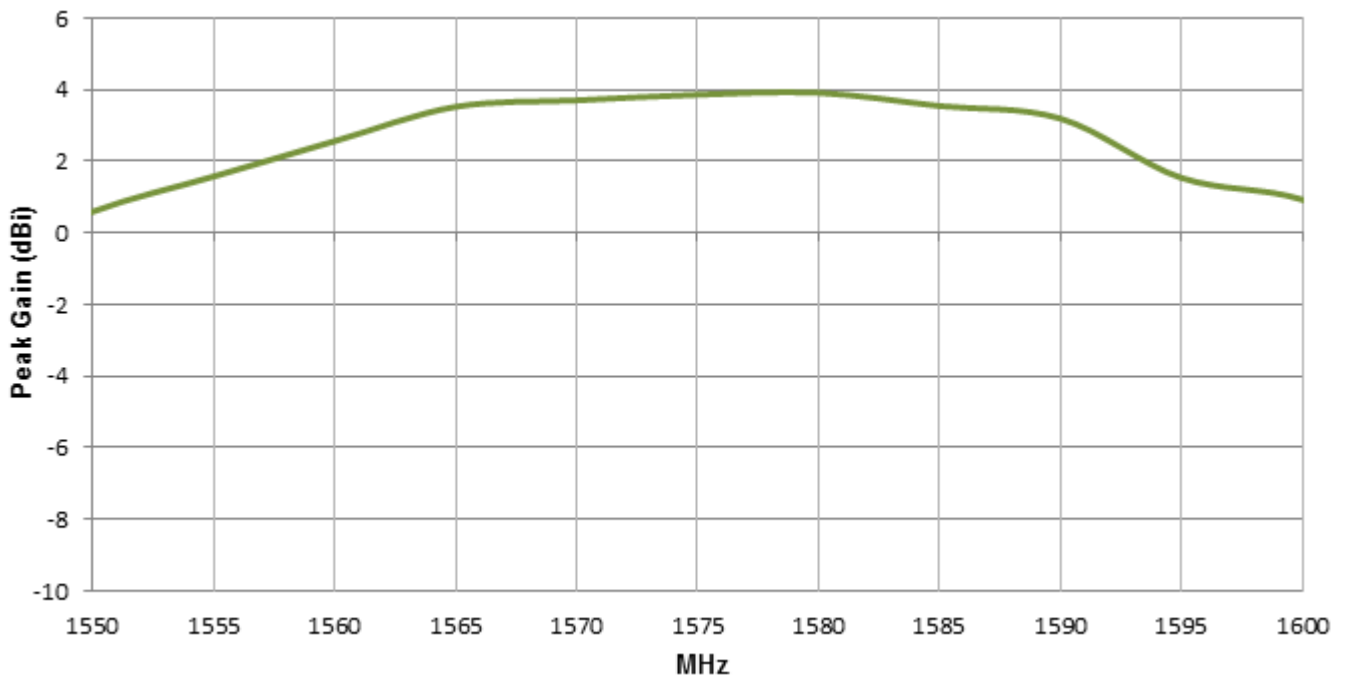
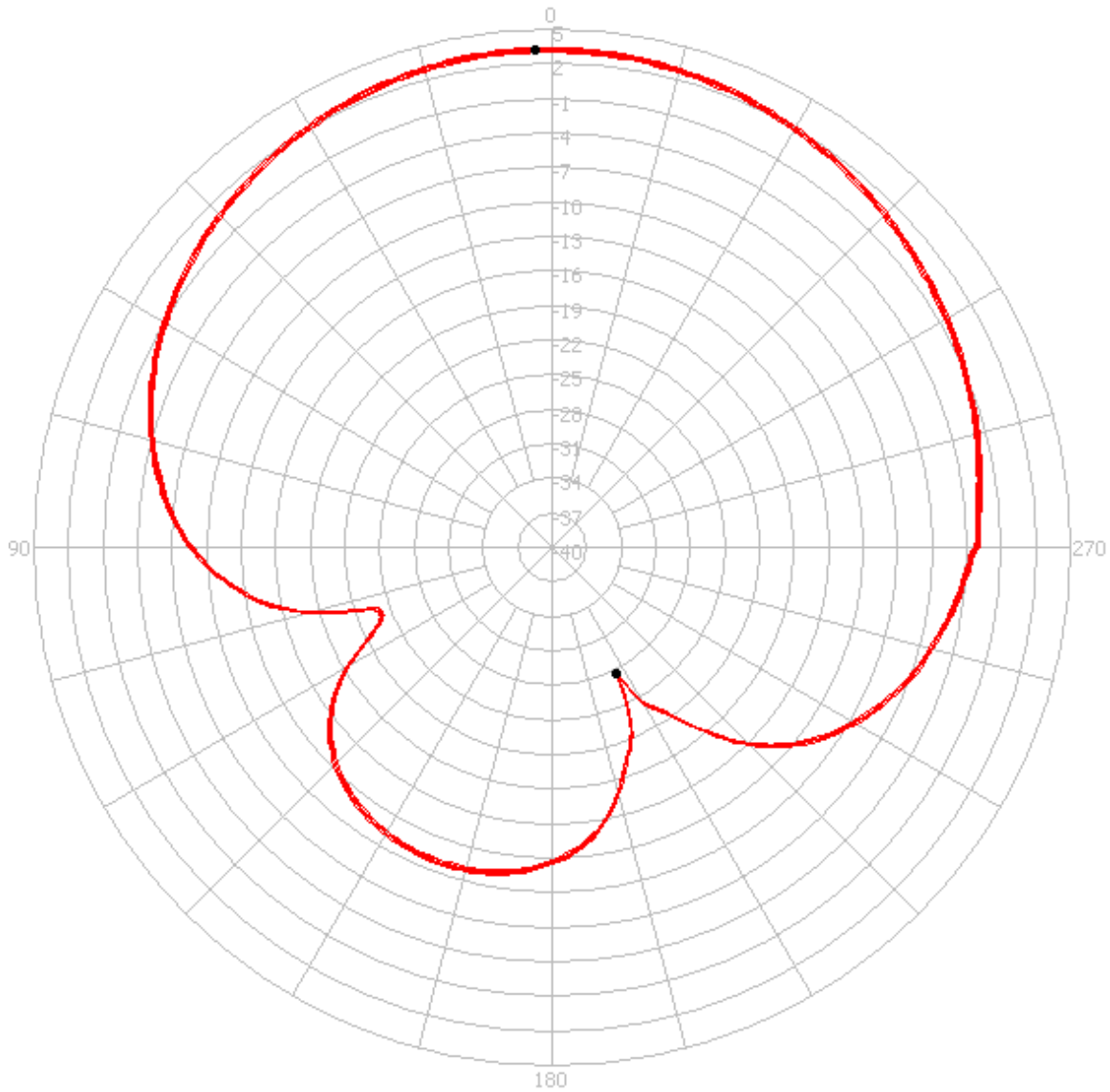

Figure 6. Peak Gain of the GP.1575.35.A.02.

5. 2D Radiation

5.1 XZ Plane Radiation



5.2 YZ Plane Radiation

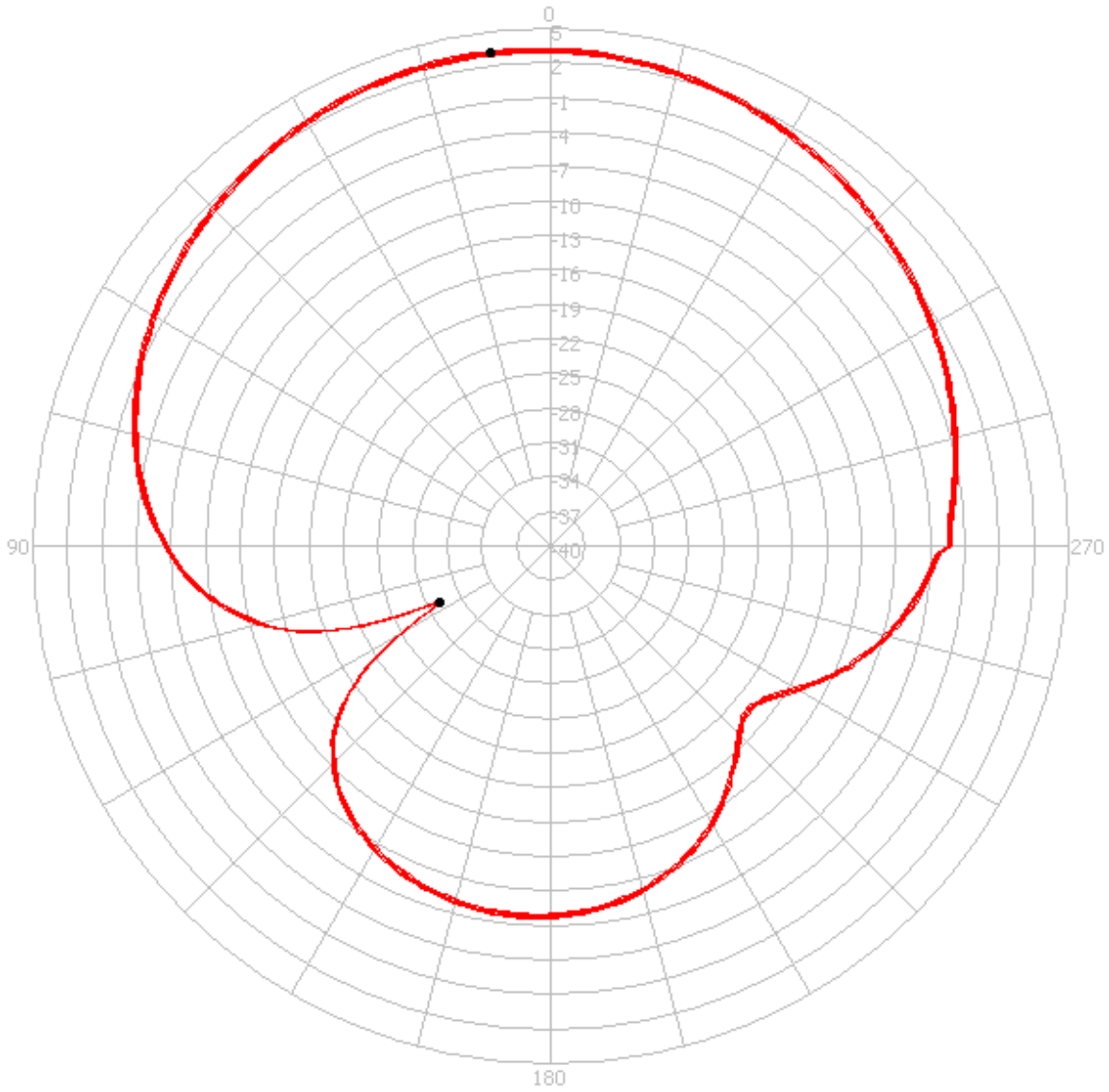

5.3 Axial Ratio

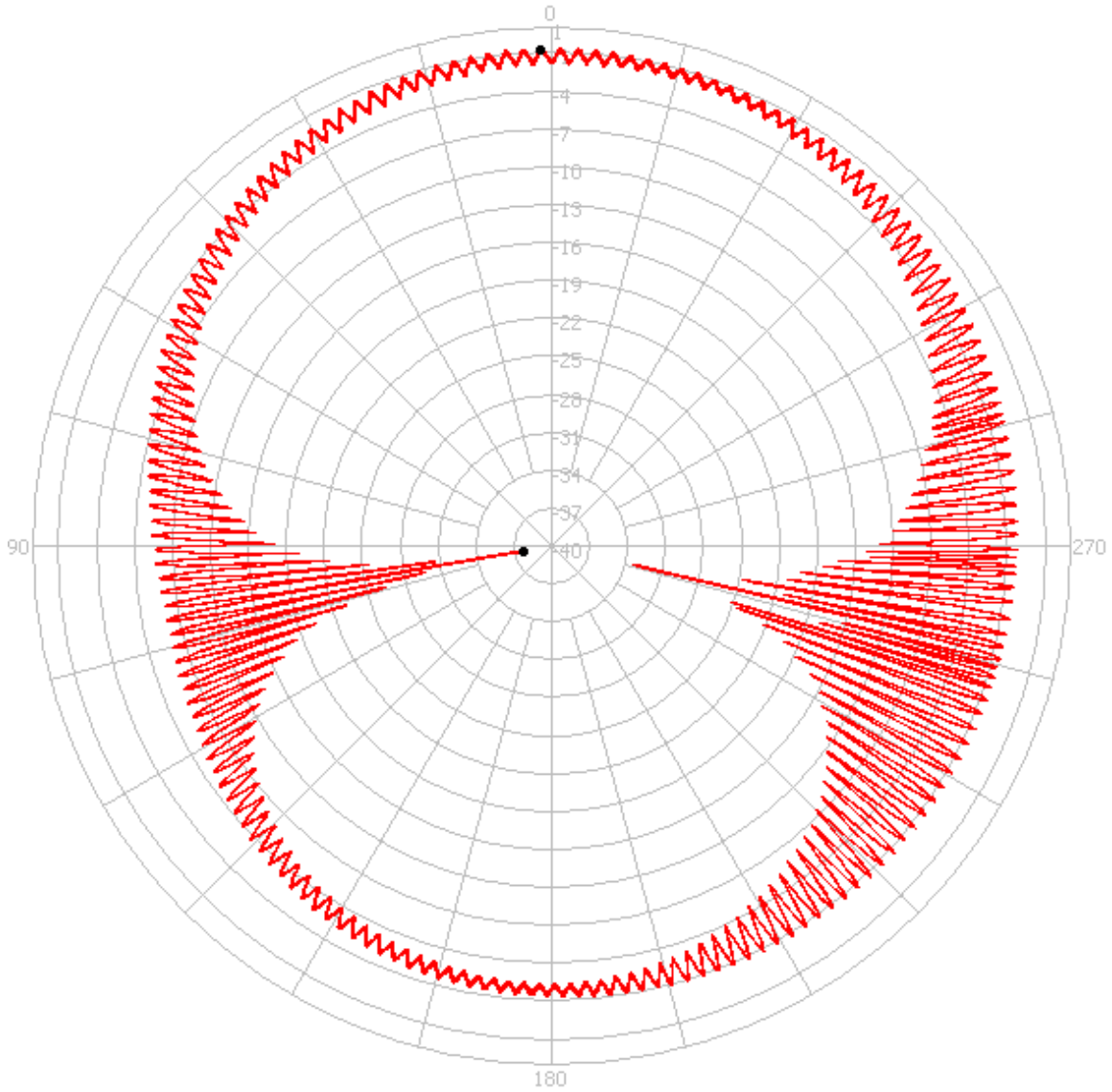

5.4 3D Radiation

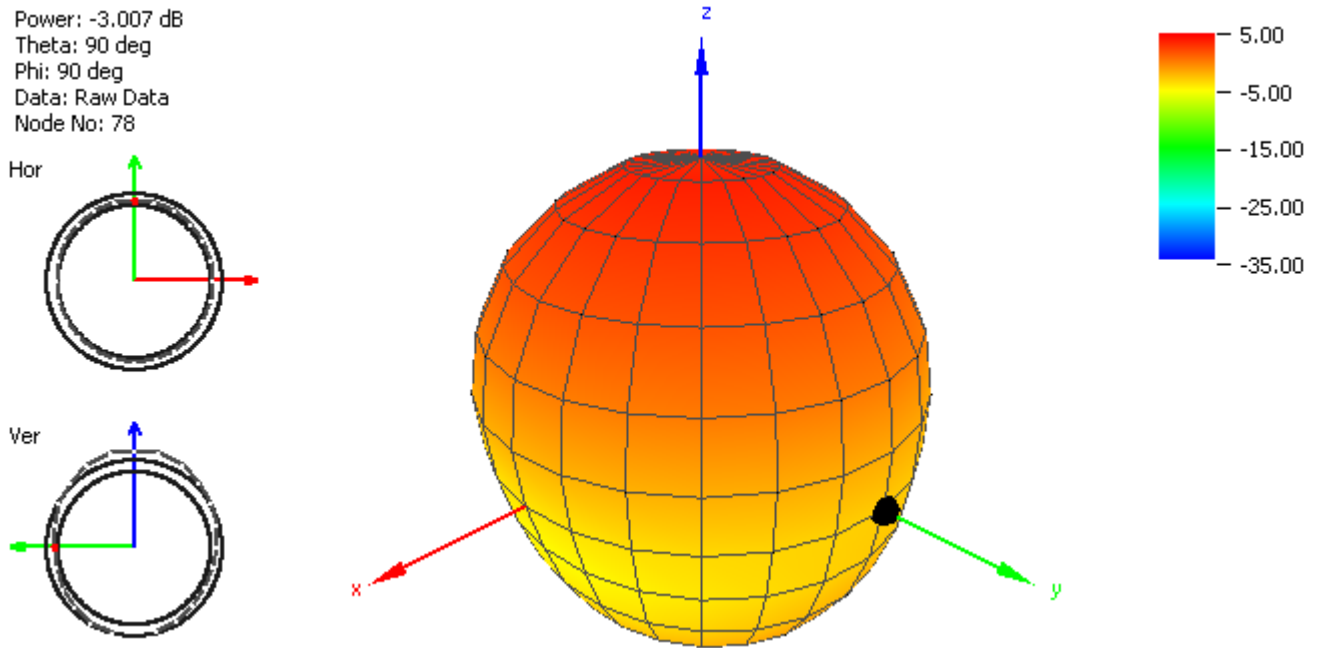
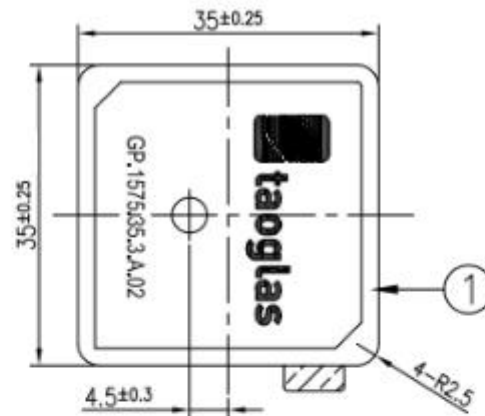

Figure 7. Radiation Pattern of the GP.1575.35.A.02 at 1575Mhz.

6 . Mechanical Drawing



Top View



Side View

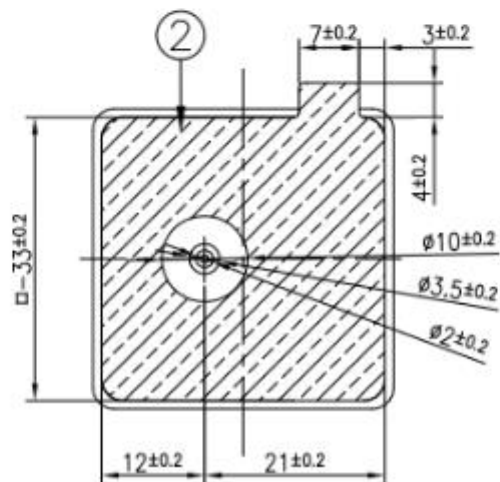

Bottom View

	Name	Material	Finish	QTY	NOTES:
1	GP.35 Patch 35x35x3.5	Ceramic	Clear	1	1.Double sided adhesive area. 
2	Double sided Adhesive	NITTO 5015	White Liner	1	

6.1 Adhesive Thickness

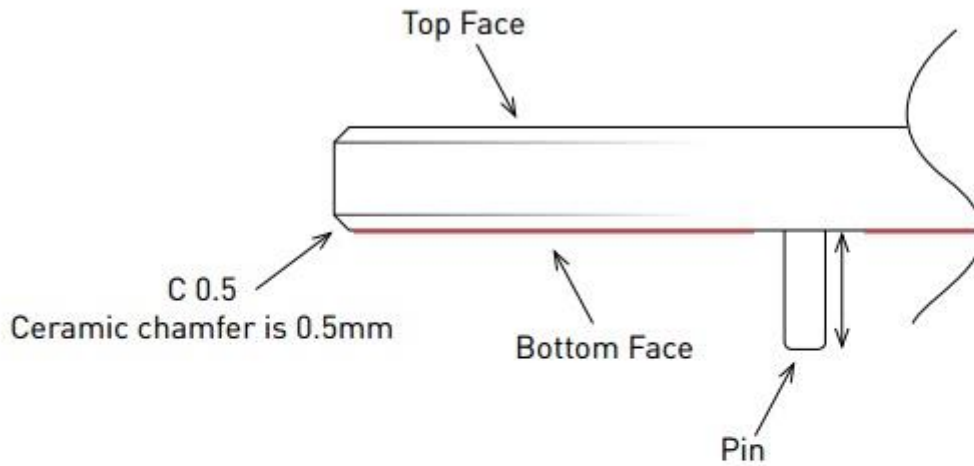

Red Line shows the adhesive without Liner – thickness 0.08–0.1mm

6.2 Layout Dimensions

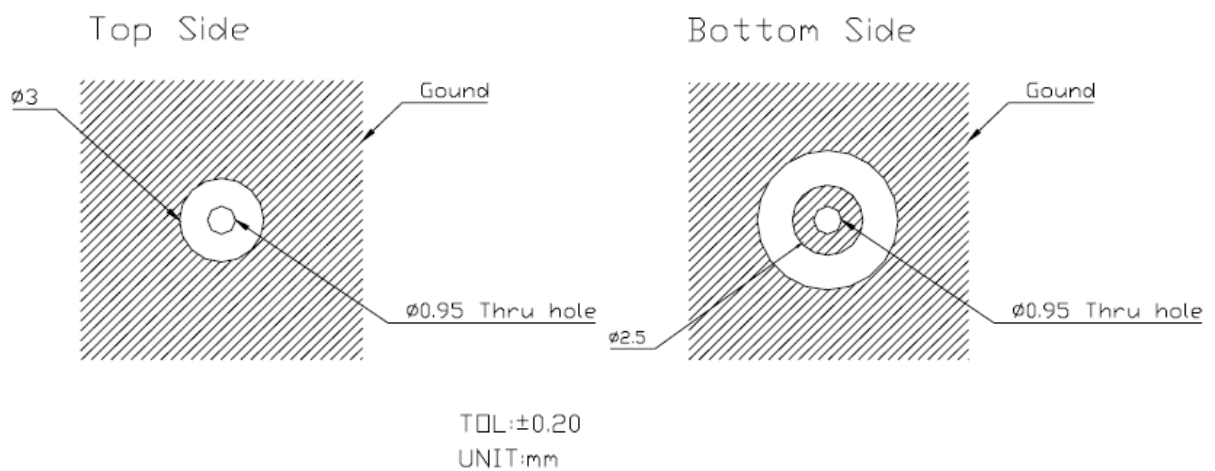

6.3 Test Fixture Antenna Setup and Measurements

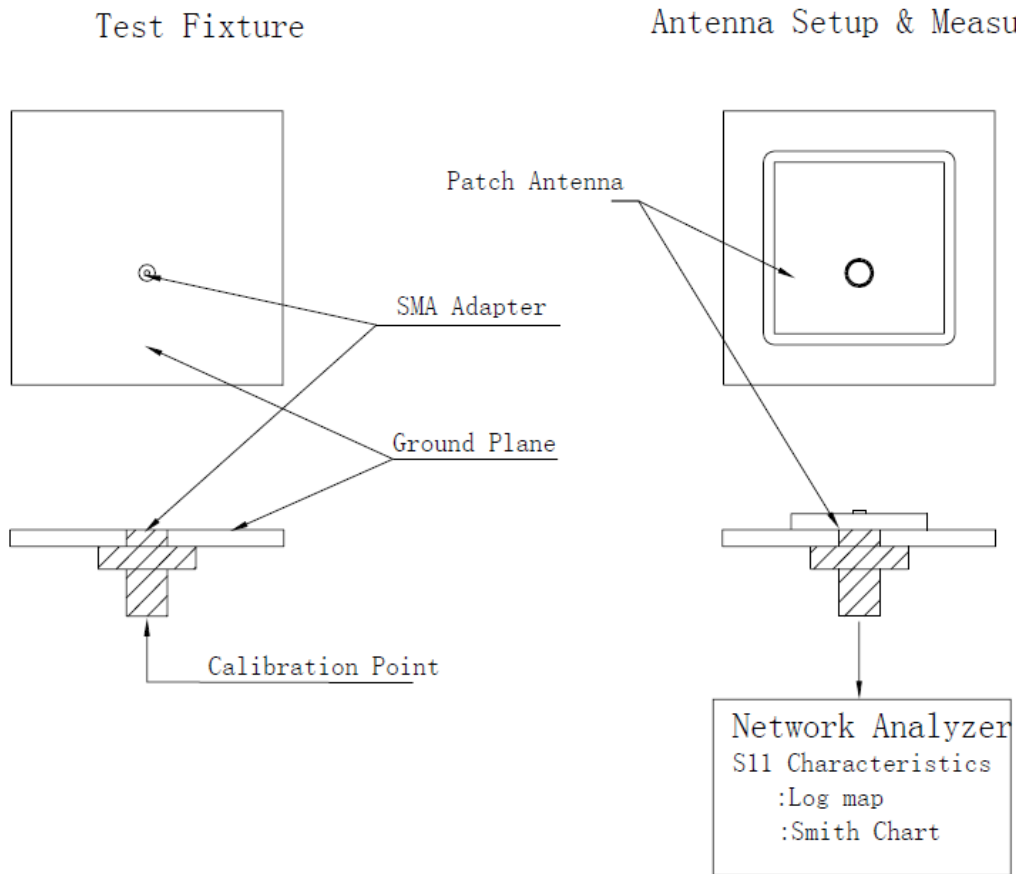

7. Packaging

GP.1575.35.3.A.02

Packaging Specifications

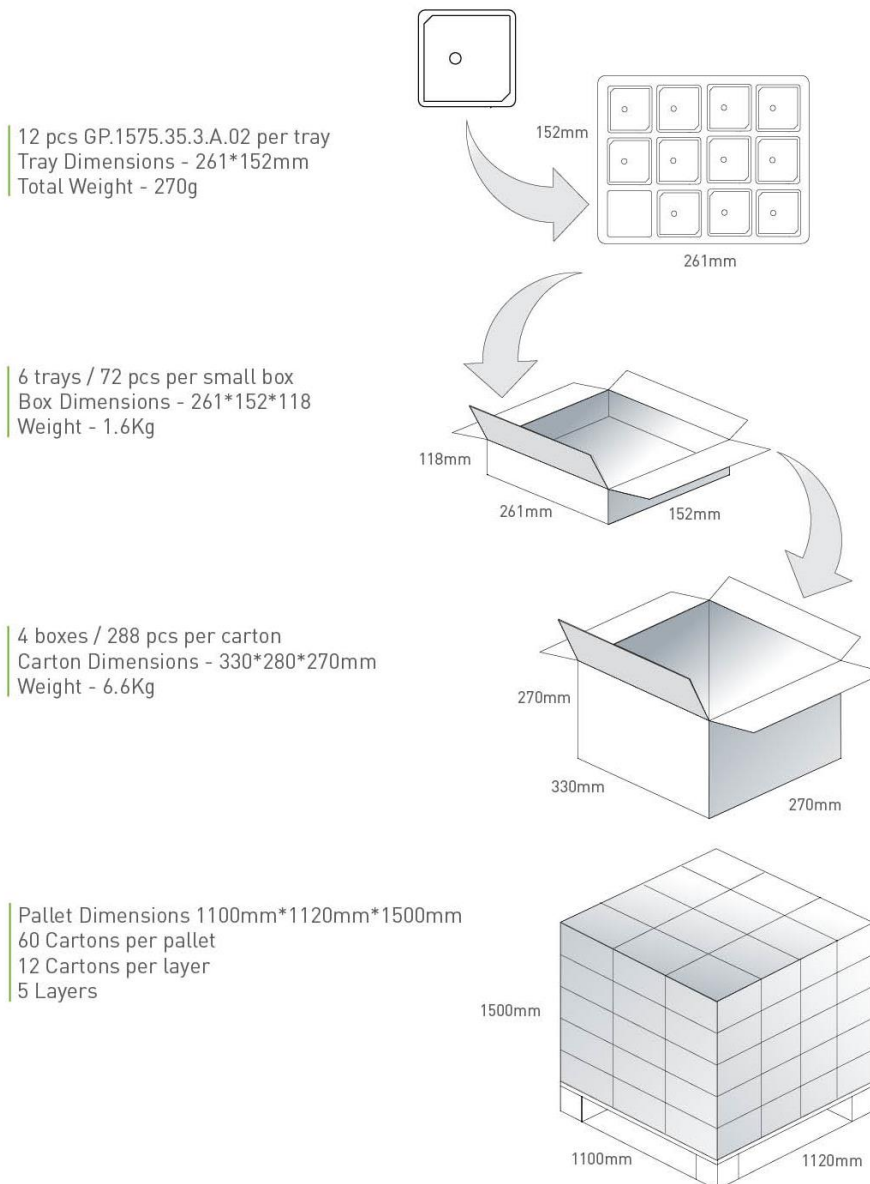

Taoglas makes no warranties based on the accuracy or completeness of the contents of this document and reserves the right to make changes to specifications and product descriptions at any time without notice. Taoglas reserves all rights to this document and the information contained herein.

Reproduction, use or disclosure to third parties without express permission is strictly prohibited.

Copyright © Taoglas Ltd.