

70mA, 70V SMD Schottky Barrier Diode

FEATURES

- Low turn-on voltage
- Fast switching
- Moisture sensitivity level: level 1, per J-STD-020
- RoHS Compliant
- Halogen-free according to IEC 61249-2-21

APPLICATIONS

- Adapters
- For switching power supply
- Low stored charge
- Inverter

MECHANICAL DATA

- Case: SOT-23
- Molding compound: UL flammability classification rating 94V-0
- Terminal: Matte tin plated leads, solderable per J-STD-002
- Meet JESD 201 class 1A whisker test
- Weight: 8 mg (approximately)

KEY PARAMETERS		
PARAMETER	VALUE	UNIT
I_F	70	mA
V_{RRM}	70	V
I_{FSM}	0.1	A
V_F at $I_F=15mA$	1	V
T_J Max.	125	°C
Package	SOT-23	



ABSOLUTE MAXIMUM RATINGS ($T_A = 25^\circ\text{C}$ unless otherwise noted)				
PARAMETER		SYMBOL	VALUE	UNIT
Marking code on the device	BAS70		73	
	BAS70-04		74	
	BAS70-05		75	
	BAS70-06		76	
Repetitive peak reverse voltage		V_{RRM}	70	V
Working peak reverse voltage		V_{RWM}	70	V
DC blocking voltage		V_R	70	V
RMS reverse voltage		$V_{R(RMS)}$	49	V
Forward current		I_F	70	mA
Non-repetitive peak forward surge current @ $t = 1s$		I_{FSM}	100	mA
Power dissipation		P_D	200	mW
Junction temperature range		T_J	-55 to +125	°C
Storage temperature range		T_{STG}	-55 to +150	°C

THERMAL PERFORMANCE			
PARAMETER	SYMBOL	TYP	UNIT
Junction-to-ambient thermal resistance	$R_{\theta JA}$	625	°C/W

ELECTRICAL SPECIFICATIONS ($T_A = 25^\circ\text{C}$ unless otherwise noted)					
PARAMETER	CONDITIONS	SYMBOL	MIN	MAX	UNIT
Forward voltage per diode ⁽¹⁾	$I_F = 1\text{mA}, T_J = 25^\circ\text{C}$	V_F	-	0.41	V
	$I_F = 15\text{mA}, T_J = 25^\circ\text{C}$			1.00	
Reverse current per diode ⁽²⁾	$V_R = 50\text{V}, T_J = 25^\circ\text{C}$	I_R	-	100	nA
Reverse Breakdown Voltage	$I_R = 10\mu\text{A}$	$V_{(BR)}$	70	-	V
Junction capacitance	$f = 1\text{MHz}, V_R = 0\text{V}$	C_J	-	2	pF
Reverse Recovery Time	$I_F = I_R = 10\text{mA}, R_L = 100\Omega,$ $I_{RR} = 1\text{mA}$	t_{rr}	-	5	ns

Notes:

1. Pulse test with $PW = 0.3\text{ms}$
2. Pulse test with $PW = 30\text{ms}$

ORDERING INFORMATION		
ORDERING CODE (Note 1)	PACKAGE	PACKING
BAS7xxxx RF	SOT-23	3K / 7" Reel
BAS7xxxx RFG	SOT-23	3K / 7" Reel
BAS7xxxx-B0 RF	SOT-23	3K / 7" Reel
BAS7xxxx-B0 RFG	SOT-23	3K / 7" Reel
BAS7xxxx-D0 RF	SOT-23	3K / 7" Reel
BAS7xxxx-D0 RFG	SOT-23	3K / 7" Reel

Note:

1. "xxxx" defines part no. from "0" to "0-06"

CHARACTERISTICS CURVES

($T_A = 25^\circ\text{C}$ unless otherwise noted)

Fig. 1 Power Derating Curve

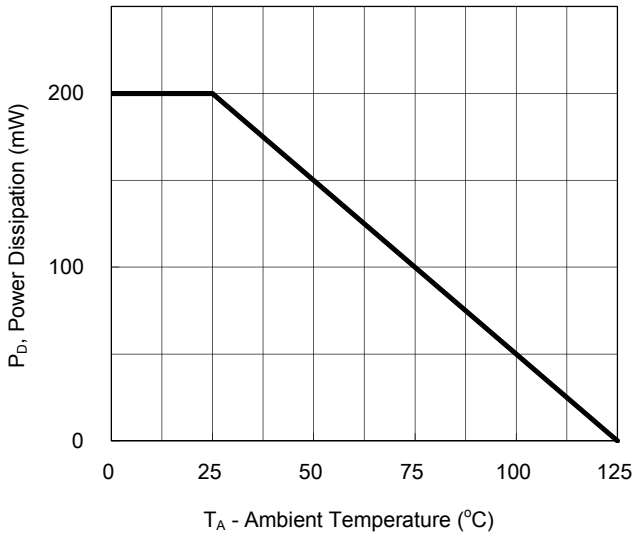

Fig.2 Maximum Non-Repetitive Peak Forward Surge Current Per Leg

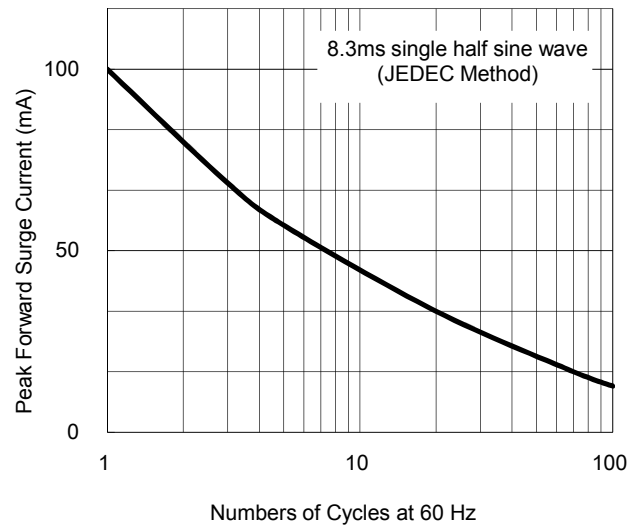

Fig.3 Typical Forward Characteristics

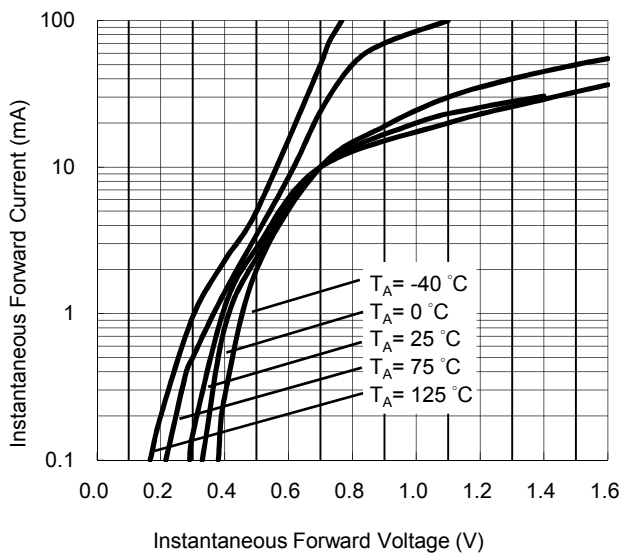
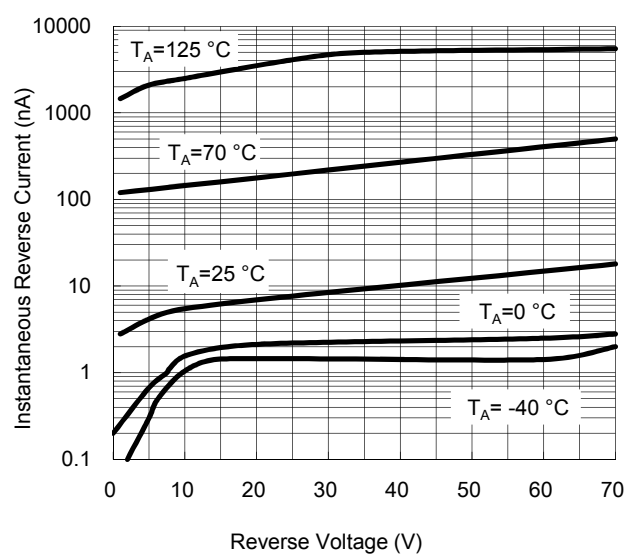

Fig.4 Typical Reverse Characteristics



CHARACTERISTICS CURVES

(T_A = 25°C unless otherwise noted)

Fig. 5 Typical Total Capacitance VS. Reverse Voltage

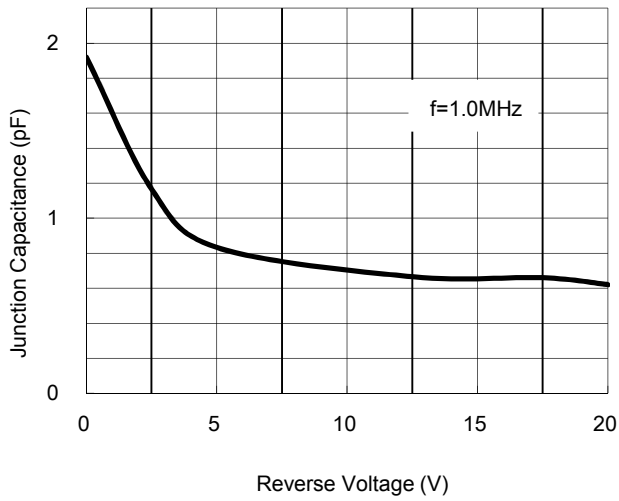
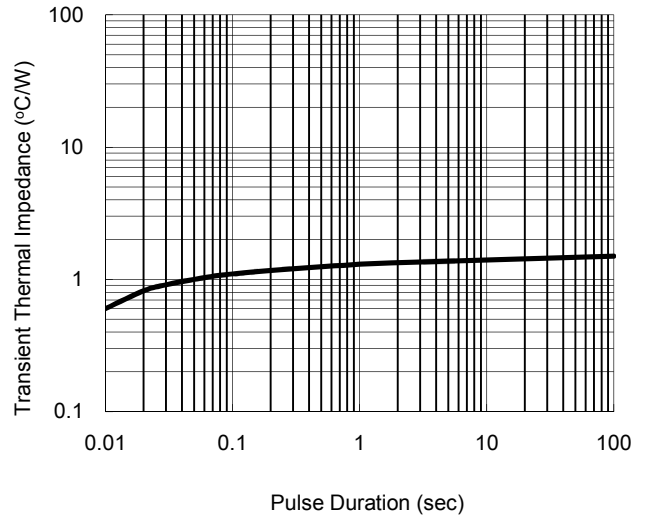
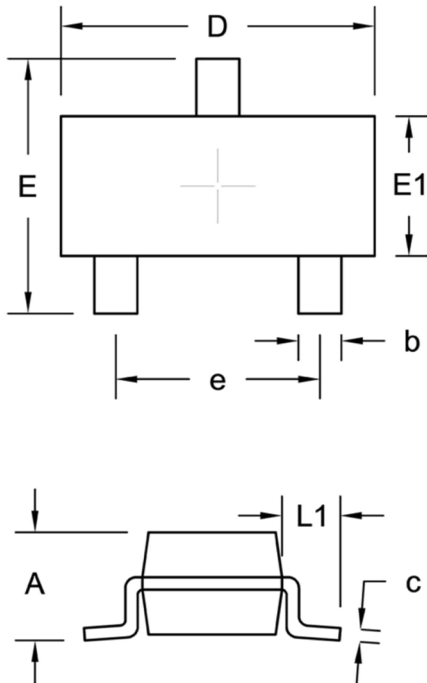

Fig.6 Typical Transient Thermal Characteristics



PACKAGE OUTLINE DIMENSION

SOT-23



DIM.	Unit (mm)		Unit (inch)	
	Min.	Max.	Min.	Max.
A	0.89	1.12	0.035	0.044
b	0.30	0.50	0.012	0.020
c	0.08	0.20	0.003	0.008
D	2.80	3.04	0.110	0.120
E	2.10	2.64	0.083	0.104
E1	1.20	1.40	0.047	0.055
e	1.90 BSC		0.075 BSC	
L1	0.54 REF.		0.021 REF.	

SUGGEST PAD LAYOUT

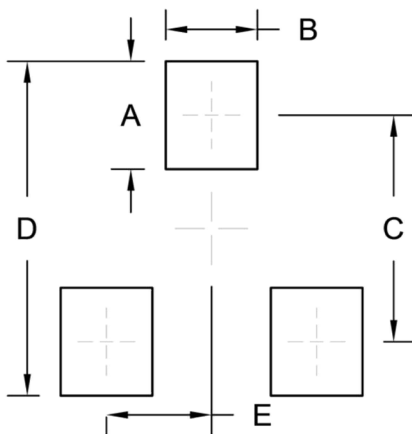

Symbol	Unit (mm)	Unit (inch)
A	1.00	0.039
B	0.85	0.033
C	2.10	0.083
D	3.10	0.122
E	0.98	0.039

PIN CONFIGURATION

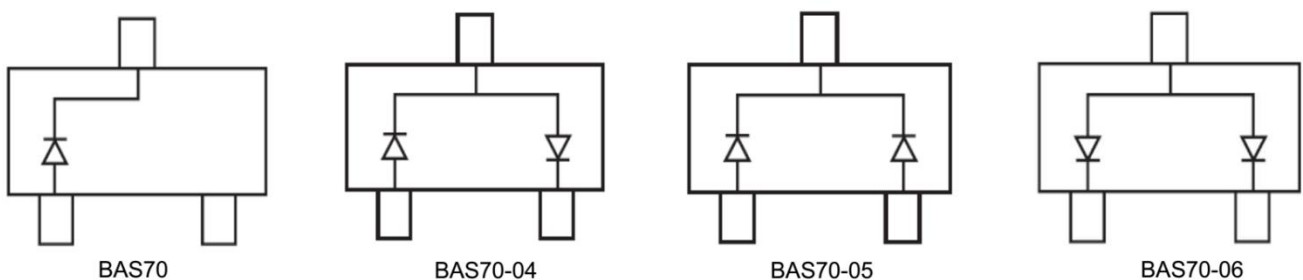

Notice

Specifications of the products displayed herein are subject to change without notice. TSC or anyone on its behalf, assumes no responsibility or liability for any errors or inaccuracies.

Purchasers are solely responsible for the choice, selection, and use of TSC products and TSC assumes no liability for application assistance or the design of Purchasers' products.

Information contained herein is intended to provide a product description only. No license, express or implied, to any intellectual property rights is granted by this document. Except as provided in TSC's terms and conditions of sale for such products, TSC assumes no liability whatsoever, and disclaims any express or implied warranty, relating to sale and/or use of TSC products including liability or warranties relating to fitness for a particular purpose, merchantability, or infringement of any patent, copyright, or other intellectual property right.

The products shown herein are not designed for use in medical, life-saving, or life-sustaining applications. Customers using or selling these products for use in such applications do so at their own risk and agree to fully indemnify TSC for any damages resulting from such improper use or sale.