



Delta 41

2G/3G/4G and WiFi Technologies Large Flat Swivel Knuckle Antenna

Key Features

- 3dBi Peak Gain
- Wide Band Antenna with multiple Technology Support
- Flat Panel Swivel Knuckle Design



General Description

The Delta 41 direct connect 2G/3G/4G antenna exhibits good performance overall, with the upper frequencies responding the best.

The swivel knuckle design is ideal for mounting on IoT modems/ routers where the antenna can be positioned for best signal reception.

An excellent all round antenna covering both WiFi technologies and telephony based transmission.

Additional Considerations

- Swivel knuckle allows positioning for best signal reception
- Suitable with a wide variety of manufacturers equipment
- Meets all EU compliance criteria for electronic goods



Delta 41

2G/3G/4G and WiFi Technologies Large Flat Swivel Knuckle Antenna

Electrical Specifications

Operating temperature:	-20 - +65°C
Impedance:	50 Ohm
Gain:	1dBi @ 698 - 960MHz 2dBi peak @ 1710 - 2170MHz 3dBi peak @ 2500 - 2700MHz
VSWR:	≤3.0:1
Frequency Range:	698 - 960MHz 1710 - 2170MHz 2500 - 2700MHz
Radiation:	Omni
Polarization:	Vertical

Mechanical Specifications

Weight:	53g
Connector:	SMA
Body Material:	ABS 757
Mounting Method:	Direct connect

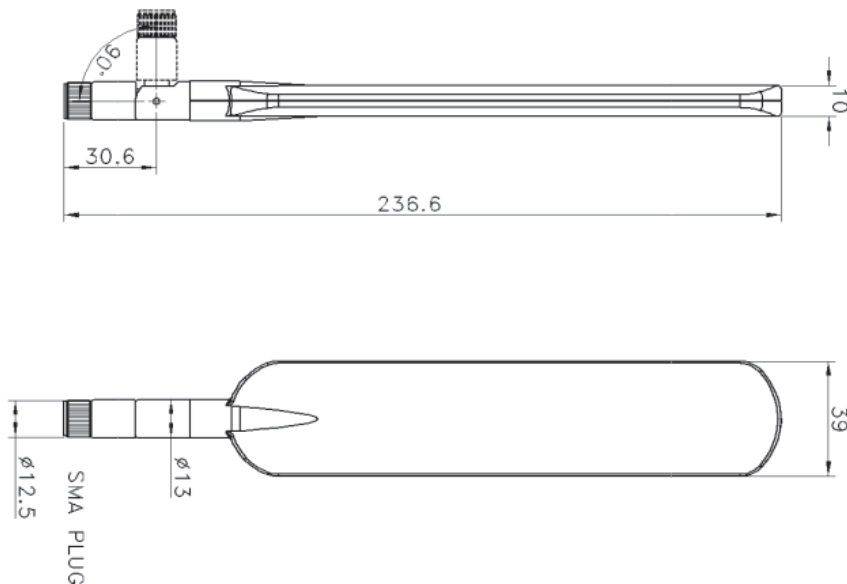



Delta 41

2G/3G/4G and WiFi Technologies Large Flat Swivel Knuckle Antenna

VSWR

Tr2 S11 SWR 1.000/ Ref 1.000 [R0]

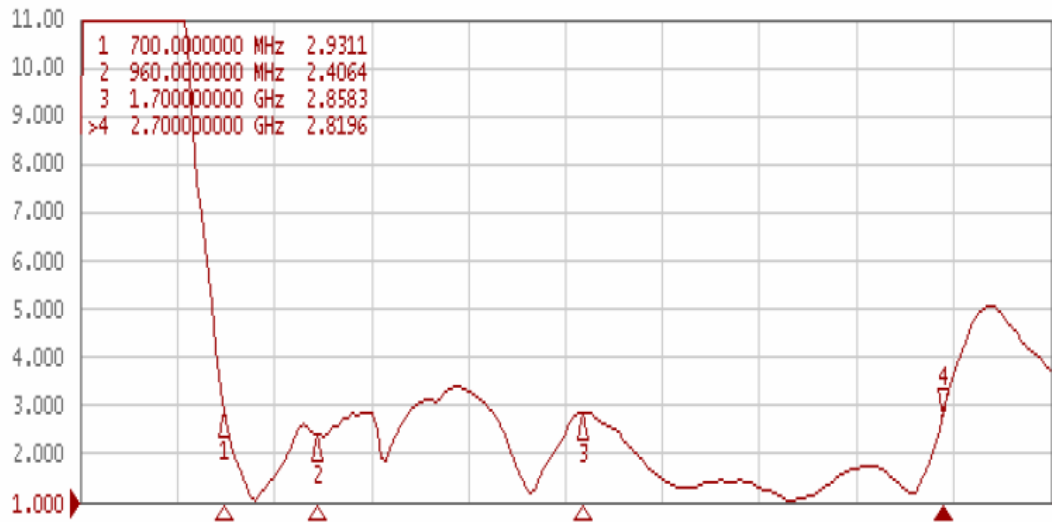

Return Loss

Tr1 S11 Log Mag 10.00dB/ Ref 0.000dB [R0]

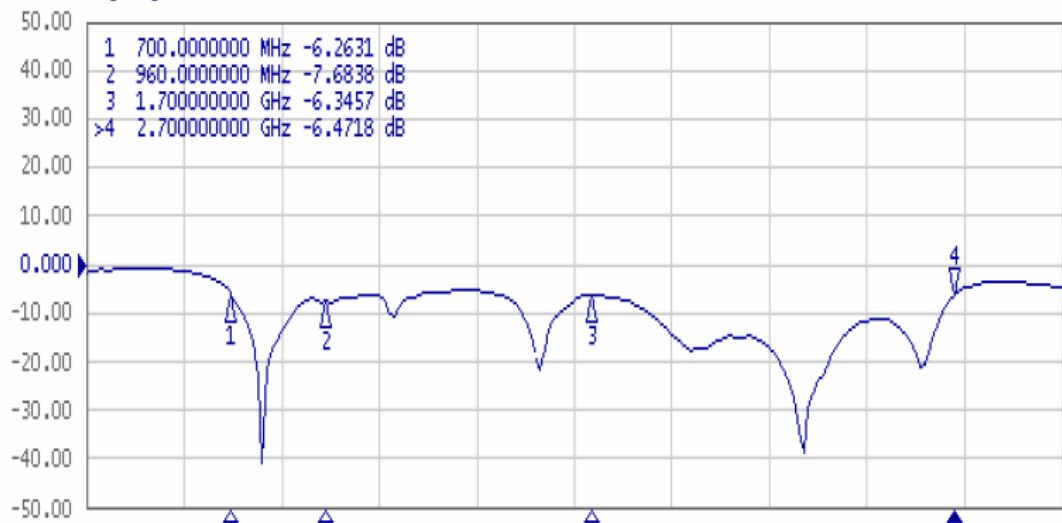



Delta 41

2G/3G/4G and WiFi Technologies Large Flat Swivel Knuckle Antenna

Radiation Patterns

700 MHz

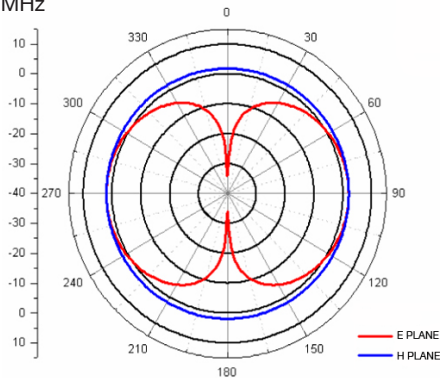

960 MHz

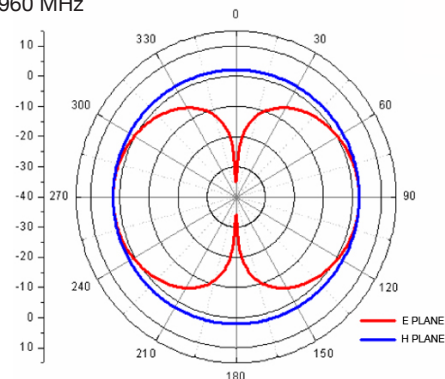

1710 MHz

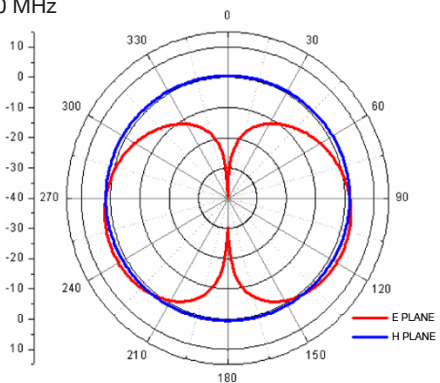

2170 MHz

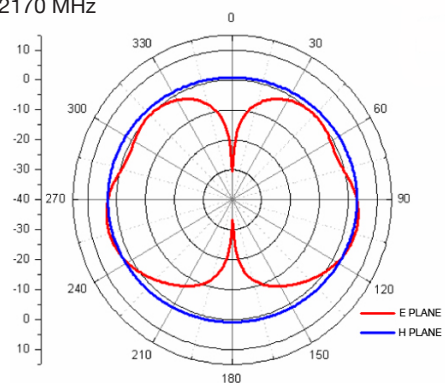

2500MHz

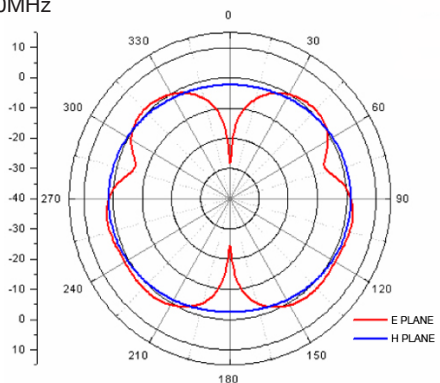

Ordering Details

Part number	Description
DELTA41/x/SMAM/S/S/32	2G/3G/4G FLAT HINGED DIRECT CONNECT ANTENNA SMA MALE CONNECTOR