



UE45-3S13D33

UE45-3S1

SAFETY RELAYS

SICK
Sensor Intelligence.



Illustration may differ



Ordering information

Type	Part no.
UE45-3S13D33	6024912

Other models and accessories → www.sick.com/UE45-3S1

Detailed technical data

Safety-related parameters

Safety integrity level	SILCL3 (EN 62061) ¹⁾ SILCL2 (EN 62061) ²⁾
Category	Category 4 (EN ISO 13849) ¹⁾ Category 3 (EN ISO 13849) ²⁾
Performance level	PL e (EN ISO 13849) ¹⁾ PL d (EN ISO 13849) ²⁾
B_{10d} parameter	4 x 10 ⁵ switching cycles (with maximum load)
PFH_D (mean probability of a dangerous failure per hour)	3.0 x 10 ⁻⁸ (EN ISO 13849) ¹⁾ 2.0 x 10 ⁻⁸ (EN ISO 13849) ²⁾
T_M (mission time)	20 years (EN ISO 13849)
Stop category	0 (EN 60204-1) ¹⁾ 1 (EN 60204-1) ²⁾

¹⁾ For contacts 13/14, 23/24.

²⁾ For time contacts 37/38.

Interfaces

Connection type	Plug-in screw-type terminals
Number of enabling current paths (N/O)	2, category 4

Electrical data

Operating data

Voltage supply	A1, A2
Output circuit > 25 V AC / 60 V DC	PELV
Output circuit ≤ 25 V AC / 60 V DC	PELV or SELV
Supply voltage V_s	A1, A2

¹⁾ In DC operation, within the limits of V_s.

	24 V DC (20.4 V DC ... 26.4 V DC)
Residual ripple	($\leq 2.4 V_{pp}$) ¹⁾
Power consumption	2.6 W (DC)
Overvoltage category	II
Rated insulation voltage U_i	300 V AC
Rated impulse withstand voltage U_{imp}	4 kV
Test voltage	2 kV (50 Hz) (EN 60439-1)

¹⁾ In DC operation, within the limits of V_S .

Control voltage: S11/S33, S21

Control voltage	22 V DC
Short-circuit current	≤ 2.2 A, between S 11 and A 2
Short-circuit protection	PTC resistor

Input circuits: S12, S31/S22

Reset time	Manual	(≤ 30 ms)
	Automatic	(≤ 600 ms)
Activation time of reset button		≤ 30 ms ≤ 600 ms
Synchronous time monitoring		≤ 500 ms
Cable resistance		$\leq 85 \Omega$

Output current paths: 13/14, 23/24, 37/38

Response time		25 ms ¹⁾
Off-delay time		0.15 s ... 3 s
Number of enabling current paths (N/O)		2, category 4
Number of off-delayed N/O contacts		1, category 3
Number of on-delayed N/O contacts		Category 3
Contact type		Positively driven
Contact material		Silver alloy, gold flashed
Switching voltage	Enabling current path	10 V AC ... 230 V AC 10 V DC ... 300 V DC
Current-carrying capacity per OSSD	Enabling current path	10 mA ... 6 A
	Total current	≤ 12 A
Usage category		AC-15/DC-13 (EN 60947-5-1)
Rated operating current (voltage)		4 A (230 V AC) 360 switching cycles/h 4 A (24 V DC) 360 switching cycles/h 2.5 A (24 V DC) 3600 switching cycles/h
Switching frequency		≤ 3600 /h
Mechanical life (relay contacts)		5×10^6 switching cycles
Electrical life (relay contacts)		2×10^6 switching cycles

¹⁾ K1/K2.

Mechanical data

Dimensions (W x H x D)	22.5 mm x 114 mm x 96.5 mm
Weight	0.2 kg

Classifications

ECl@ss 5.0	27371990
ECl@ss 5.1.4	27371990
ECl@ss 6.0	27371819
ECl@ss 6.2	27371819
ECl@ss 7.0	27371819
ECl@ss 8.0	27371819
ECl@ss 8.1	27371819
ECl@ss 9.0	27371819
ECl@ss 10.0	27371819
ECl@ss 11.0	27371819
ETIM 5.0	EC001449
ETIM 6.0	EC001449
ETIM 7.0	EC001449
UNSPSC 16.0901	41113704

Dimensional drawing (Dimensions in mm (inch))

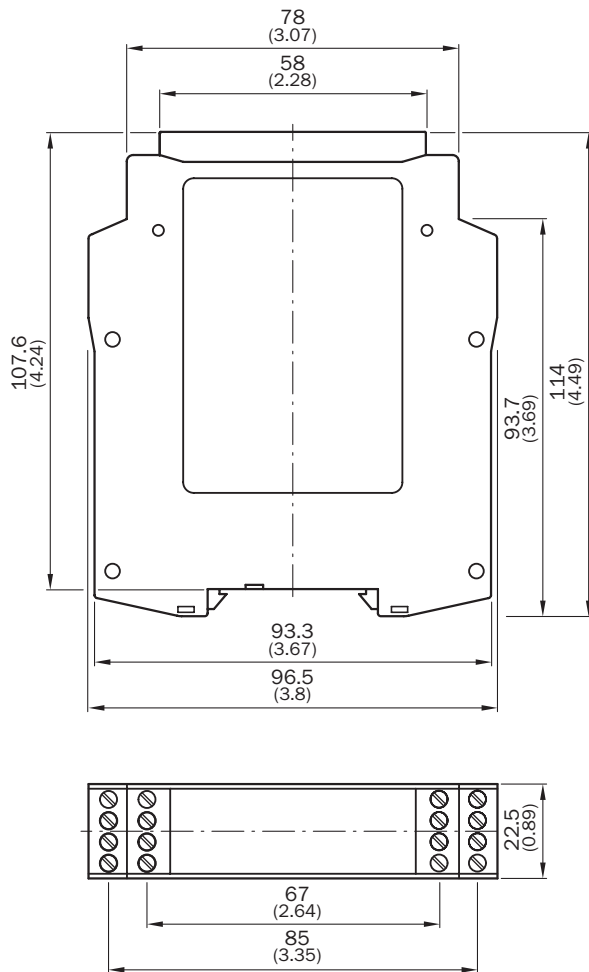

Connection diagram

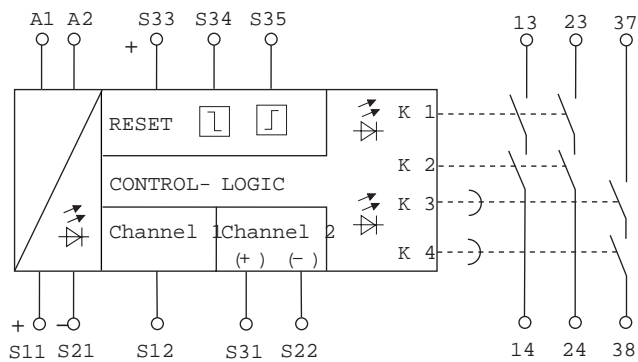

SICK AT A GLANCE

SICK is one of the leading manufacturers of intelligent sensors and sensor solutions for industrial applications. A unique range of products and services creates the perfect basis for controlling processes securely and efficiently, protecting individuals from accidents and preventing damage to the environment.

We have extensive experience in a wide range of industries and understand their processes and requirements. With intelligent sensors, we can deliver exactly what our customers need. In application centers in Europe, Asia and North America, system solutions are tested and optimized in accordance with customer specifications. All this makes us a reliable supplier and development partner.

Comprehensive services complete our offering: SICK LifeTime Services provide support throughout the machine life cycle and ensure safety and productivity.

For us, that is “Sensor Intelligence.”

WORLDWIDE PRESENCE:

Contacts and other locations –www.sick.com