



# PBT-RP050SN1SS0AMA0Z

PBT

PRESSURE SENSORS

**SICK**  
Sensor Intelligence.



Illustration may differ



### Ordering information

| Type                 | Part no. |
|----------------------|----------|
| PBT-RP050SN1SS0AMA0Z | 6054257  |

Other models and accessories → [www.sick.com/PBT](http://www.sick.com/PBT)

### Detailed technical data

#### Features

|                            |                        |
|----------------------------|------------------------|
| <b>Medium</b>              | Liquid, gaseous        |
| <b>Pressure type</b>       | Gauge pressure         |
| <b>Pressure unit</b>       | psi                    |
| <b>Measuring range</b>     | 0 psi ... 50 psi       |
| <b>Process temperature</b> | 0 °C ... +80 °C        |
| <b>Output signal</b>       | 4 mA ... 20 mA, 2-wire |
| <b>Specialty</b>           | Without                |

#### Mechanics/electronics

|                                    |   |
|------------------------------------|---|
| <b>Process connection</b>          | ¼" NPT  |
| <b>Wetted parts</b>                | Pressure Connection: stainless steel 316L<br>Pressure sensor: stainless steel 316L (for measurement ranges from 0 bar ... 10 bar rel stainless steel 13-8 PH)                                   |
| <b>Internal transmission fluid</b> | Silicone oil (only with pressure ranges < 0 bar ... 10 bar and ≤ 0 bar abs ... 25 bar abs)  |
| <b>Pressure port</b>               | , Standard  |
| <b>Housing material</b>            | Stainless steel   |
| <b>Connection type</b>             | Round connector M12 x 1, 4-pin, IP67  |
| <b>Supply voltage</b>              | 8 V DC ... 30 V DC with output signal 4 mA ... 20 mA and 0 V ... 5 V<br>14 V DC ... 30 V DC with output signal 0 V ... 10 V<br>8 V DC ... 30 V DC <sup>1)</sup>                                 |
| <b>Power consumption</b>           | Signal current (max. 25 mA) for current output<br>Max. 8 mA for voltage output signal   |
| <b>Electrical safety</b>           | Overvoltage protection: 32 V DC, 36 V DC with 4 mA ... 20 mA<br>Short-circuit protection: Q <sub>A</sub> towards M<br>Reverse polarity protection: L <sup>+</sup> to M<br>Protection class: III |
| <b>Isolation voltage</b>           | 500 V DC  |
| <b>CE-conformity</b>               | Pressure equipment directive: 2014/68/EU, EMC directive: 2014/30/EU, EN 61 326-2-3  |
| <b>Weight sensor</b>               | Approx. 80 g  |

<sup>1)</sup> The pressure transmitter must be supplied with power by a limited energy circuit compliant with 9.3 of UL/EN/IEC 601010-1 or LPS to UL/EN/IEC 60950-1 or Class 2 to UL 1310/UL1585 (NEC or CEC). The power supply must be suitable for operation above 2,000 m if the pressure transmitter is used above this altitude.

|                             |  |
|-----------------------------|--|
| <b>Seal</b>                 | Without seal                                   |
| <b>Enclosure rating</b>     | IP67   |
| <b>Protection class III</b> | ✓  |
| <b>Reference conditions</b> | Reference conditions: According to IEC 61298-1 |
| <b>MTTF</b>                 | 815 years                                      |

<sup>1)</sup> The pressure transmitter must be supplied with power by a limited energy circuit compliant with 9.3 of UL/EN/IEC 601010-1 or LPS to UL/EN/IEC 60950-1 or Class 2 to UL 1310/UL1585 (NEC or CEC). The power supply must be suitable for operation above 2,000 m if the pressure transmitter is used above this altitude.

## Performance

|   |   |
|---|---|
| <b>Non-linearity</b>                      | ≤ ± 0.5 %, (Best Fit Straight Line, BFSL) according to IEC 61298-2    |
| <b>Accuracy</b>                           | ≤ ± 1 % of the span   |
| <b>Adjustment accuracy of zero signal</b> | ≤ 0.5 % of span typ., ≤ 0.8 % of span max. (with non-linearity 0.5 %) |
| <b>Hysteresis</b>                         | ≤ 0.16 % of the span  |
| <b>Non-repeatability</b>                  | ≤ 0.1 % of the span   |
| <b>Response time</b>                      | < 4 ms  |
| <b>Signal noise</b>                       | ≤ 0.3 % of the span   |
| <b>Long-term drift/one-year stability</b> | ≤ 0.1 % of span to IEC 61298-2  |
| <b>Rated temperature range</b>            | 0 °C ... +80 °C   |
| <b>Service life</b>                       | Minimum 100 Mio. life cycles  |

## Ambient data

|                            |  |
|----------------------------|--|
| <b>Ambient temperature</b> | 0 °C ... +80 °C  |
| <b>Storage temperature</b> | -40 °C ... +70 °C  |
| <b>Relative humidity</b>   | 45 % ... 75 %  |
| <b>Shock load</b>          | 500 g according to IEC 60068-2-27 (mechanical shock)                         |
| <b>Vibration load</b>      | 10 g according to IEC 60068-2-6 (vibration under resonance)<br>20 g optional |

## Classifications

|                       |          |
|-----------------------|----------|
| <b>ECl@ss 5.0</b>     | 27200614 |
| <b>ECl@ss 5.1.4</b>   | 27200614 |
| <b>ECl@ss 6.0</b>     | 27200614 |
| <b>ECl@ss 6.2</b>     | 27200614 |
| <b>ECl@ss 7.0</b>     | 27200614 |
| <b>ECl@ss 8.0</b>     | 27200614 |
| <b>ECl@ss 8.1</b>     | 27200614 |
| <b>ECl@ss 9.0</b>     | 27200614 |
| <b>ECl@ss 10.0</b>    | 27200614 |
| <b>ECl@ss 11.0</b>    | 27200614 |
| <b>ETIM 5.0</b>       | EC002476 |
| <b>ETIM 6.0</b>       | EC002476 |
| <b>ETIM 7.0</b>       | EC002476 |
| <b>UNSPSC 16.0901</b> | 41112410 |

**Dimensional drawing** (Dimensions in mm (inch))

1/4" NPT

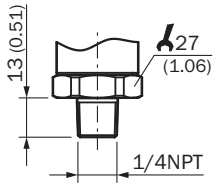

Housing with circular connector M12 x 1, IP67

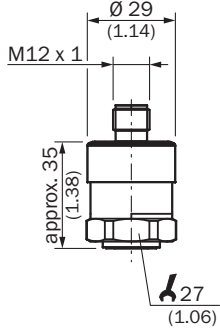



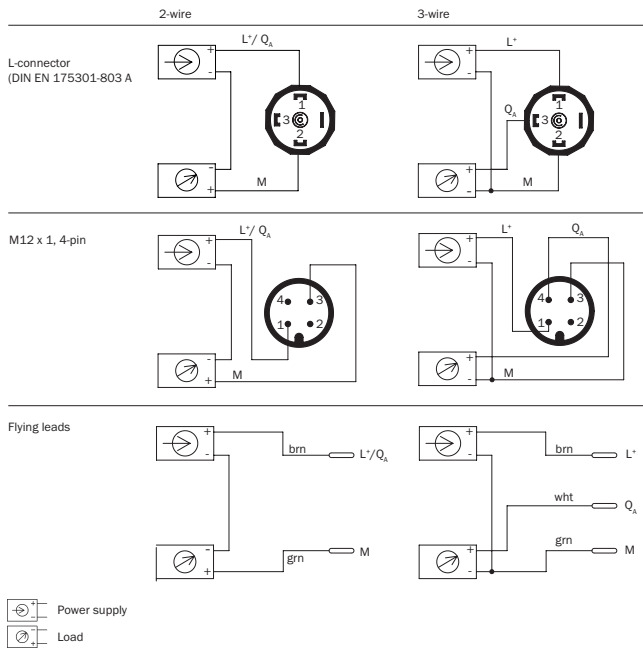





**Connection type**



## Recommended accessories

Other models and accessories → [www.sick.com/PBT](http://www.sick.com/PBT)

|   | Brief description  | Type               | Part no. |
|---|--|--------------------|----------|
| <b>Mounting brackets and plates</b>   |  |                    |          |
|    | Mounting bracket for simple and stable wall mounting of pressure sensors with 27 mm hexagon, Aluminum  | BEF-FL-ALUPBS-HLDR | 5322501  |
| <b>Plug connectors and cables</b>   |  |                    |          |
|    | Head A: female connector, M12, 4-pin, angled<br>Head B: Flying leads<br>Cable: PVC, unshielded, 5 m  | DOL-1204-W05MD     | 6020399  |
|    | Head A: female connector, M12, 4-pin, straight, A-coded<br>Head B: Flying leads<br>Cable: Sensor/actuator cable, PUR, halogen-free, unshielded, 2 m  | YF2A14-020UB3XLEAX | 2095607  |
|    | Head A: female connector, M12, 4-pin, straight, A-coded<br>Head B: Flying leads<br>Cable: Sensor/actuator cable, PVC, unshielded, 2 m                | YF2A14-020VB3XLEAX | 2096234  |
|    | Head A: female connector, M12, 4-pin, straight, A-coded<br>Head B: Flying leads<br>Cable: Sensor/actuator cable, PVC, unshielded, 5 m                | YF2A14-050VB3XLEAX | 2096235  |
|    | Head A: female connector, M12, 4-pin, straight, A-coded<br>Head B: Flying leads<br>Cable: Sensor/actuator cable, PUR, halogen-free, unshielded, 10 m | YF2A14-100UB3XLEAX | 2095609  |
|   | Head A: female connector, M12, 4-pin, straight, A-coded<br>Head B: Flying leads<br>Cable: Sensor/actuator cable, PVC, unshielded, 10 m               | YF2A14-100VB3XLEAX | 2096236  |
|  | Head A: female connector, M12, 4-pin, straight, A-coded<br>Head B: Flying leads<br>Cable: Sensor/actuator cable, PUR, halogen-free, unshielded, 15 m | YF2A14-150UB3XLEAX | 2095610  |
|  | Head A: female connector, M12, 4-pin, straight, A-coded<br>Head B: Flying leads<br>Cable: Sensor/actuator cable, PVC, unshielded, 15 m               | YF2A14-150VB3XLEAX | 2096237  |
|  | Head A: female connector, M12, 4-pin, straight, A-coded<br>Head B: Flying leads<br>Cable: Sensor/actuator cable, PUR, halogen-free, unshielded, 20 m | YF2A14-200UB3XLEAX | 2095611  |
|  | Head A: female connector, M12, 4-pin, straight, A-coded<br>Head B: Flying leads<br>Cable: Sensor/actuator cable, PVC, unshielded, 20 m               | YF2A14-200VB3XLEAX | 2096238  |
|  | Head A: female connector, M12, 4-pin, straight, A-coded<br>Head B: Flying leads<br>Cable: Sensor/actuator cable, PUR, halogen-free, unshielded, 25 m | YF2A14-250UB3XLEAX | 2095615  |
|  | Head A: female connector, M12, 4-pin, angled, A-coded<br>Head B: Flying leads<br>Cable: Sensor/actuator cable, PUR, halogen-free, unshielded, 2 m    | YG2A14-020UB3XLEAX | 2095766  |
|  | Head A: female connector, M12, 4-pin, angled, A-coded<br>Head B: Flying leads<br>Cable: Sensor/actuator cable, PVC, unshielded, 2 m                  | YG2A14-020VB3XLEAX | 2095895  |
|  | Head A: female connector, M12, 4-pin, angled, A-coded<br>Head B: Flying leads<br>Cable: Sensor/actuator cable, PUR, halogen-free, unshielded, 5 m    | YG2A14-050UB3XLEAX | 2095767  |

|  | Brief description  | Type               | Part no. |
|--|--|--------------------|----------|
|   | Head A: female connector, M12, 4-pin, angled, A-coded<br>Head B: Flying leads<br>Cable: Sensor/actuator cable, PVC, unshielded, 5 m                | YG2A14-050VB3XLEAX | 2095897  |
|   | Head A: female connector, M12, 4-pin, angled, A-coded<br>Head B: Flying leads<br>Cable: Sensor/actuator cable, PUR, halogen-free, unshielded, 10 m | YG2A14-100UB3XLEAX | 2095768  |
|   | Head A: female connector, M12, 4-pin, angled, A-coded<br>Head B: Flying leads<br>Cable: Sensor/actuator cable, PVC, unshielded, 10 m               | YG2A14-100VB3XLEAX | 2095898  |
|   | Head A: female connector, M12, 4-pin, angled, A-coded<br>Head B: Flying leads<br>Cable: Sensor/actuator cable, PUR, halogen-free, unshielded, 15 m | YG2A14-150UB3XLEAX | 2095769  |
|   | Head A: female connector, M12, 4-pin, angled, A-coded<br>Head B: Flying leads<br>Cable: Sensor/actuator cable, PVC, unshielded, 15 m               | YG2A14-150VB3XLEAX | 2096213  |
|   | Head A: female connector, M12, 4-pin, angled, A-coded<br>Head B: Flying leads<br>Cable: Sensor/actuator cable, PUR, halogen-free, unshielded, 20 m | YG2A14-200UB3XLEAX | 2095770  |
|   | Head A: female connector, M12, 4-pin, angled, A-coded<br>Head B: Flying leads<br>Cable: Sensor/actuator cable, PVC, unshielded, 20 m               | YG2A14-200VB3XLEAX | 2096214  |
|  | Head A: female connector, M12, 4-pin, angled, A-coded<br>Head B: Flying leads<br>Cable: Sensor/actuator cable, PUR, halogen-free, unshielded, 25 m | YG2A14-250UB3XLEAX | 2095771  |

## SICK AT A GLANCE

SICK is one of the leading manufacturers of intelligent sensors and sensor solutions for industrial applications. A unique range of products and services creates the perfect basis for controlling processes securely and efficiently, protecting individuals from accidents and preventing damage to the environment.

We have extensive experience in a wide range of industries and understand their processes and requirements. With intelligent sensors, we can deliver exactly what our customers need. In application centers in Europe, Asia and North America, system solutions are tested and optimized in accordance with customer specifications. All this makes us a reliable supplier and development partner.

Comprehensive services complete our offering: SICK LifeTime Services provide support throughout the machine life cycle and ensure safety and productivity.

For us, that is “Sensor Intelligence.”

## WORLDWIDE PRESENCE:

Contacts and other locations –[www.sick.com](http://www.sick.com)