

# Compact Performance EMI Filter

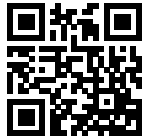

- Rated currents from 3 to 16 A
- Economic high performance filter



### Performance indicators

Attenuation performance



Rated current [A]



### Approvals



### Features and benefits

- FN 9675 filters are designed for easy and fast chassis mounting.
- FN 9675 offers an economic combination of performance/size ratio.
- All filters provide a high symmetrical and asymmetrical attenuation performance, based on chokes with high saturation resistance and excellent thermal behavior.
- Economic high performance filter attenuation suitable to be used in a broad range of applications.
- Fast connection with additional spade solder possibility or screw connection.
- Custom-specific versions on request.

### Technical specifications

<b>Maximum continuous operating voltage</b>	250 VAC, 50/60 Hz
<b>Operating frequency</b>	dc to 400 Hz
<b>Rated currents</b>	3 to 16 A @ 40 °C max.
<b>High potential test voltage</b>	P → PE 2000 VAC for 2 sec P → N 760 VAC for 2 sec
<b>Temperature range (operation and storage)</b>	-25 °C to +100 °C (25/100/21)
<b>Flammability corresponding to</b>	UL 94 V-2 or better
<b>Design corresponding to</b>	UL 1283, CSA 22.2 No. 8 1986, IEC/EN 60939
<b>MTBF @ 40°C/230V (Mil-HB-217F)</b>	400,000 hours (FN 9675) 280,000 hours (FN 9676)

### Typical applications

- Electrical and electronic equipment
- Consumer goods
- Household equipment
- Power supplies
- Office automation equipment
- Datacom equipment

### Typical electrical schematic

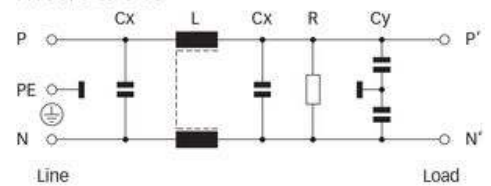

FN 9675-3/-6-06

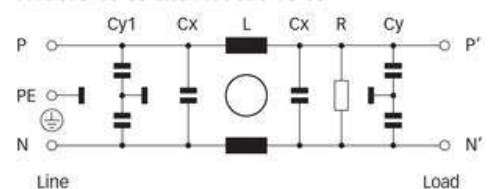

FN 9675-16-03 and FN 9676-16-03



### Filter selection table

Filter	Rated current @ 40 °C (25 °C)	Leakage current* @ 230 VAC/50 Hz	Inductance L	Capacitance			Resistance R	Input/Output connections		Weight
	[A]	[µA]	[mH]	Cx [nF]	Cy [nF]	Cy1 [nF]	[kΩ]			[g]
FN 9675-3-06	3 (3.5)	410	18	680	4.7		470		-06	270
FN 9675-6-06	6 (6.9)	410	3	680	4.7		470		-06	270
FN 9675-16-03	16 (18.4)	410	10.2	1000	4.7		470		-03	850
FN 9676-16-03	16 (18.4)	1900	10.2	1000	15	6.8	470		-03	1050

\* Maximum leakage under normal operating conditions. Note: if the neutral line is interrupted, worst case leakage could reach twice this level.

### Typical filter attenuation

Per CISPR 17; A = 50 Ω/50 Ω sym; B = 50 Ω/50 Ω asym; C = 0.1 Ω/100 Ω sym; D = 100 Ω/0.1 Ω sym

3 A types

6 A types

16 A types (FN 9675)

16 A types (FN 9676)

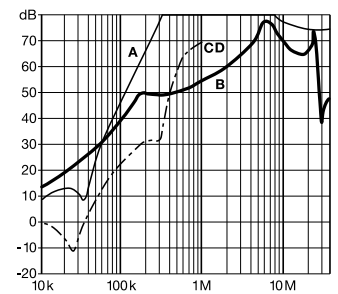
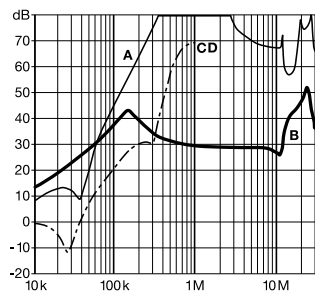
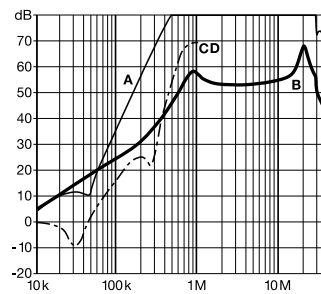
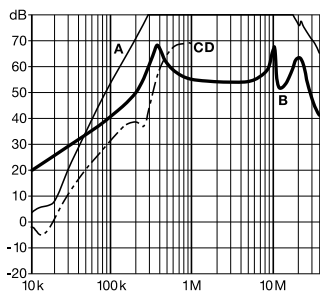

### Mechanical data

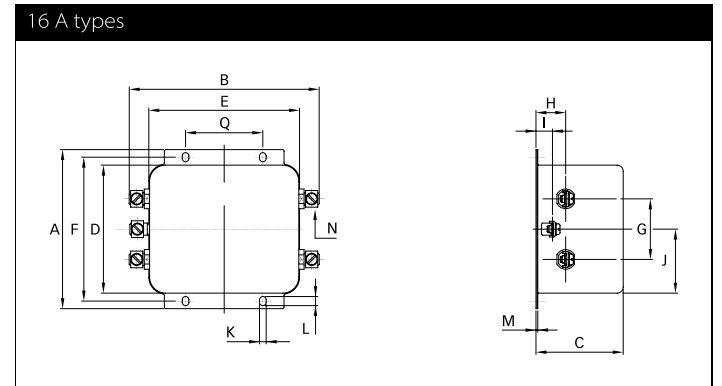
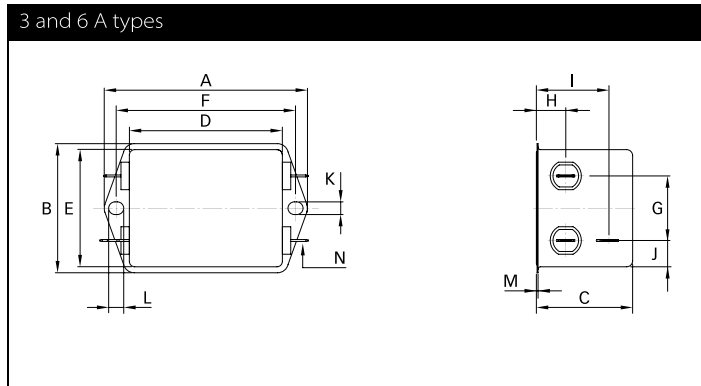

### Dimensions

	3 A	6 A	16 A	Tolerances
A	85	85	105	±0.5
B	54	54	126	±0.5
C	40.3	54	126	±1
D	40.3	40.3	57	±1
E	64.4	64.4	84.5	±0.5
F	49.8	49.8	99.5	±0.2
G	27	27	40	±0.5
H	12.3	12.3	19	±0.5
I	29.8	29.8	11	±0.5
J	11.4	11.4	42.25	±0.5
K	5.3	5.3	4.4	
L	6.3	6.3	6	
M	0.7	0.7	1.2	
N	6.3 x 0.8	6.3 X 0.8	UNC 8-32	
Q			51	±0.1

All dimensions in mm; 1 inch = 25.4 mm  
Tolerances according: ISO 2768-m / EN 22768-m



## Headquarters, global innovation and development center

### Switzerland

#### Schaffner Group

Nordstrasse 11  
4542 Luterbach  
T +41 32 6816 626  
F +41 32 6816 630  
[info@schaffner.com](mailto:info@schaffner.com)  
<http://www.schaffner.com>



## Sales and application centers

### China

#### Schaffner EMC Ltd. Shanghai

T20-3, No 565 Chuangye Road  
Pudong New Area  
201201 Shanghai  
T +86 21 3813 9500  
F +86 21 3813 9501 / 02  
[cschina@schaffner.com](mailto:cschina@schaffner.com)  
<http://www.schaffner.com.cn/>

### Finland

#### Schaffner Oy

Sauvonrinne 19 H  
08500 Lohja  
T +358 19 35 72 71  
[finlandsales@schaffner.com](mailto:finlandsales@schaffner.com)

### France

#### Schaffner EMC S.A.S.

112 Quai de Bezons  
Boîte postale 133  
95100 Argenteuil  
T +33 1 34 34 30 60  
F +33 1 39 47 02 28  
[francesales@schaffner.com](mailto:francesales@schaffner.com)

### Germany

#### Schaffner Deutschland GmbH

Schoemperlenstrasse 12B  
76185 Karlsruhe  
T +49 721 56910  
F +49 721 569110  
[germanysales@schaffner.com](mailto:germanysales@schaffner.com)

### Italy

#### Schaffner EMC S.r.l.

Via Galileo Galilei 47  
20092 Cinisello Balsamo (MI)  
T +39 02 66 04 30 45/47  
F +39 02 61 23 943  
[italysales@schaffner.com](mailto:italysales@schaffner.com)

### Japan

#### Schaffner EMC K.K.

1-32-12, Kamiyama, Setagaya-ku  
7F Mitsui-seimei Sangenjaya Bldg.  
154-0011 Tokyo  
T +81 3 5712 3650  
F +81 3 5712 3651  
[japansales@schaffner.com](mailto:japansales@schaffner.com)  
<http://www.schaffner.jp>

### Singapore

#### Schaffner EMC Pte Ltd.

Blk 3015A Ubi Road 1  
05-09 Kampong Ubi Industrial Estate  
408705 Singapore  
T +65 6377 3283  
F +65 6377 3281  
[singaporesales@schaffner.com](mailto:singaporesales@schaffner.com)

### Spain

#### Schaffner EMC España

Calle Caléndula 93, Miniparc III, Edificio E,  
Alcobendas  
Miniparc III, Edificio E  
El Soto de la Moraleja  
Alcobendas  
28109 Madrid  
M +34 618 176 133  
T +34 917 912 900  
F +34 917 912 901  
[spainsales@schaffner.com](mailto:spainsales@schaffner.com)

### Sweden

#### Schaffner EMC AB

Turebergstorg 1, 6  
19147 Sollentuna  
T +46 8 5792 1121 / 22  
F +46 8 92 96 90  
[swedensales@schaffner.com](mailto:swedensales@schaffner.com)

### Switzerland

#### Schaffner EMV AG

Nordstrasse 11  
4542 Luterbach  
T +41 32 6816 626  
F +41 32 6816 641  
[sales@schaffner.ch](mailto:sales@schaffner.ch)

### Taiwan R.O.C.

#### Schaffner EMV Ltd.

6 Floor, No. 413  
Rui Guang Road  
114 Neihu District Taipei City  
T +886 2 87525050  
F +886 2 87518086  
[taiwansales@schaffner.com](mailto:taiwansales@schaffner.com)

### Thailand

#### Schaffner EMC Co. Ltd.

Northern Region Industrial Estate  
67 Moo 4 Tambon Ban Klang  
Amphur Muang P.O. Box 14  
51000 Lamphun  
T +66 53 58 11 04  
F +66 53 58 10 19  
[thailandsales@schaffner.com](mailto:thailandsales@schaffner.com)

### UK

#### Schaffner Ltd.

5 Ashville Way  
Molly Millars Lane  
Wokingham  
RG41 2PL Berkshire  
T +44 118 9770070  
F +44 118 9792969  
[uksales@schaffner.com](mailto:uksales@schaffner.com)  
<http://www.schaffner.uk.com>

### USA

#### Schaffner EMC Inc.

52 Mayfield Avenue  
08837 Edison, New Jersey  
T +1 800 367 5566  
T +1 732 225 9533  
F +1 732 225 4789  
[usasales@schaffner.com](mailto:usasales@schaffner.com)  
<http://www.schaffner.com/us>

#### Schaffner MTC LLC

6722 Thirlane Road  
24019 Roanoke, Virginia  
T +1 276 228 7943  
F +1 276 228 7953  
<http://www.schaffner-mtc.com>

#### Schaffner Trencos LLC

2550 Brookpark Road  
44134 Cleveland, Ohio  
T +1 216 741 5282  
F +1 216 741 4860  
<http://schaffner-trencos.com>

To find your local partner within Schaffner's global network: [www.schaffner.com](http://www.schaffner.com)

© 2014 Schaffner Group

The content of this document has been carefully checked and understood. However, neither Schaffner nor its subsidiaries assume any liability whatsoever for any errors or inaccuracies of this document and the consequences thereof. Published specifications are subject to change without notice. Product suitability for any area of application must ultimately be determined by the customer. In all cases, products must never be operated outside their published specifications. Schaffner does not guarantee the availability of all published products. This disclaimer shall be governed by substantive Swiss law and resulting disputes shall be settled by the courts at the place of business of Schaffner Holding AG. Latest publications and a complete disclaimer can be downloaded from the Schaffner website. All trademarks recognized.