



120×120×25 mm

San Ace 120 9GA type Low Power Consumption Fan 

General Specifications

- Material Frame: Plastic (Flammability: UL 94V-0), Impeller: Plastic (Flammability: UL 94V-0)
- Expected life See the table below. (L10 life: 90% survival rate for continuous operation in free air at 60°C, rated voltage)
Expected life at 40°C is for reference only.
- Motor protection function Locked rotor burnout protection, Reverse polarity protection
For details, please refer to p. 573.
- Dielectric strength 50/60 Hz, 500 VAC, for 1 minute (between lead wire conductors and frame)
- Insulation resistance 10 MΩ or more with a 500 VDC megger (between lead wire conductors and frame)
- Sound pressure level (SPL) At 1 m away from the air inlet
- Storage temperature -30 to +70°C (Non-condensing)
- Lead wire ⊕Red ⊖Black (Sensor) Yellow (Control) Brown
(For models without PWM control function, there is no speed control wiring.)
- Mass 280 g

Specifications

The models listed below **have ribs and pulse sensors with PWM control function.** For models without ribs, append "1" to the end of model numbers.

Model no.	Rated voltage [V]	Operating voltage range [V]	PWM duty cycle [%]	Rated current [A]	Rated input [W]	Rated speed [min ⁻¹]	Max. airflow [m ³ /min] [CFM]	Max. static pressure [Pa] [inchH ₂ O]	SPL [dB (A)]	Operating temperature [°C]	Expected life [h]
» 9GA1212P4G001	12	10.2 to 13.8	100	0.93	11.16	6400	3.8 134	365 1.47	57	-20 to +70	40000/60°C (70000/40°C)
» 9GA1212P4S001			25	0.16	1.92	2550	1.5 53	60 0.24	34		
» 9GA1224P4G001	24	20.4 to 27.6	100	0.47	11.28	6400	3.8 134	365 1.47	57		
» 9GA1224P4S001			25	0.1	2.4	2550	1.5 53	60 0.24	34		
» 9GA1248P4G001	48	40.8 to 53	100	0.24	11.52	6400	3.8 134	365 1.47	57		
» 9GA1248P4S001			25	0.08	3.84	2550	1.5 53	60 0.24	34		

* PWM input frequency is 25 kHz; models without specifications at 0% PWM duty cycle have zero fan speed at 0%.

The following sensor and control options are available for selection.

Available for all models. **Pulse sensor**

Differs according to the model. Refer to the table on p. 605. **Without sensor** **Lock sensor**

The models listed below **have ribs and pulse sensors.** For models without ribs, append "1" to the end of model numbers.

Model no.	Rated voltage [V]	Operating voltage range [V]	Rated current [A]	Rated input [W]	Rated speed [min ⁻¹]	Max. airflow [m ³ /min] [CFM]	Max. static pressure [Pa] [inchH ₂ O]	SPL [dB (A)]	Operating temperature [°C]	Expected life [h]
» 9GA1212G4001	12	7 to 13.8	0.93	11.16	6400	3.8 134	365 1.47	57	-20 to +70	40000/60°C (70000/40°C)
» 9GA1212S4001			0.61	7.32	5400	3.2 113	260 1.04	54		
» 9GA1224G4001	24	14 to 27.6	0.47	11.28	6400	3.8 134	365 1.47	57		
» 9GA1224S4001			0.31	7.44	5400	3.2 113	260 1.04	54		
» 9GA1248G4001	48	36 to 53	0.24	11.52	6400	3.8 134	365 1.47	57		
» 9GA1248S4001			0.16	7.68	5400	3.2 113	260 1.04	54		

The following sensor and control options are available for selection.

Available for all models. **PWM control**

Differs according to the model. Refer to the table on p. 605. **Without sensor** **Lock sensor**

The » mark indicates Short LeadTime Service applicable models. See p. 626 for details.

Airflow - Static Pressure Characteristics / PWM Duty - Speed Characteristics Example

9GA1212P4G001 With pulse sensor with PWM control function

PWM duty cycle

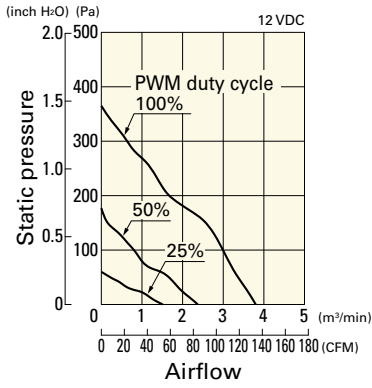

Operating voltage range

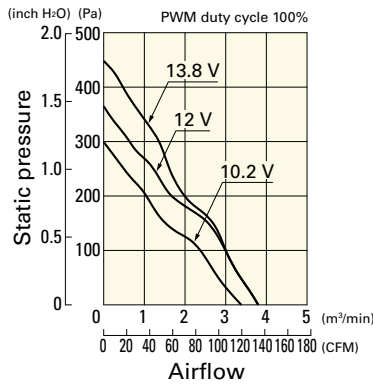

PWM duty - Speed characteristics example

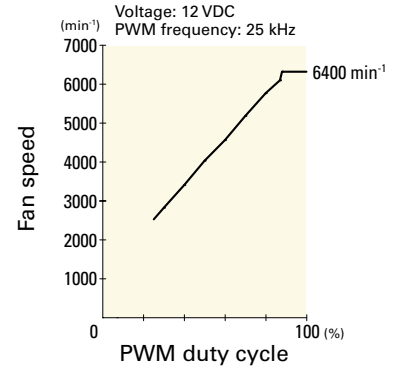

9GA1212P4S001 With pulse sensor with PWM control function

PWM duty cycle

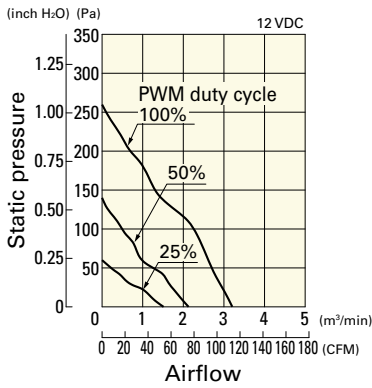

Operating voltage range

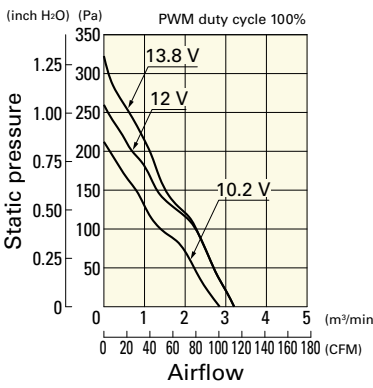

PWM duty - Speed characteristics example

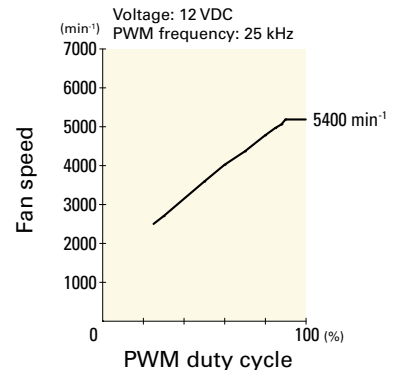

9GA1224P4G001 With pulse sensor with PWM control function

PWM duty cycle

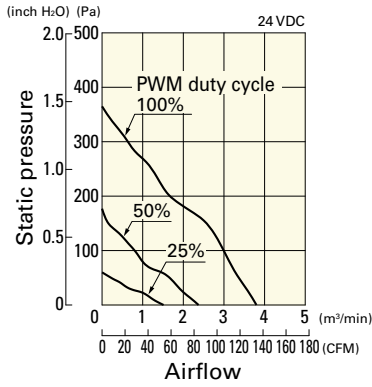

Operating voltage range

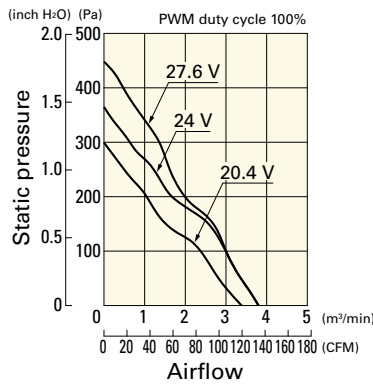

PWM duty - Speed characteristics example

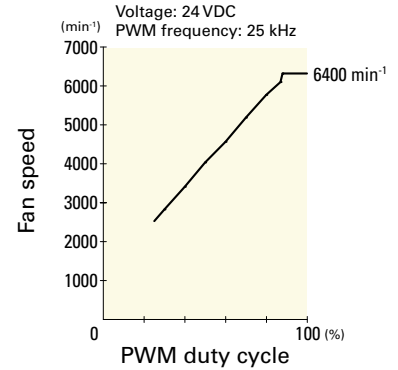

9GA1224P4S001 With pulse sensor with PWM control function

PWM duty cycle

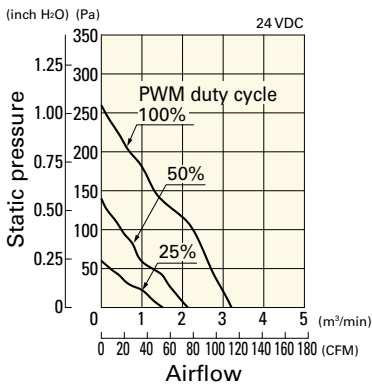

Operating voltage range

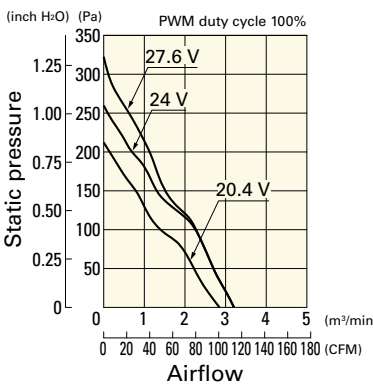

PWM duty - Speed characteristics example

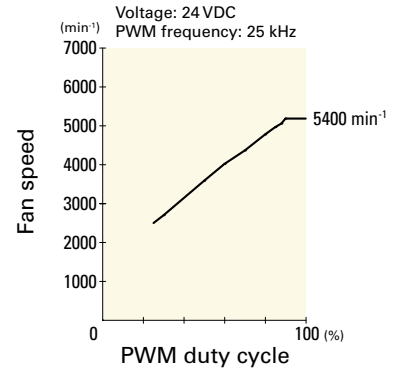

Airflow - Static Pressure Characteristics / PWM Duty - Speed Characteristics Example

9GA1248P4G001 With pulse sensor with PWM control function

PWM duty cycle

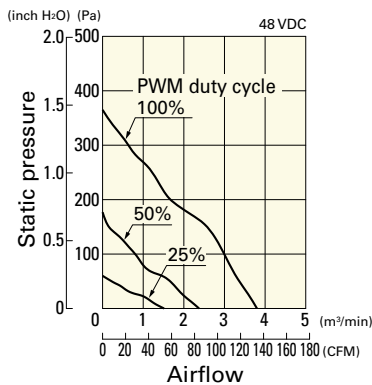

Operating voltage range

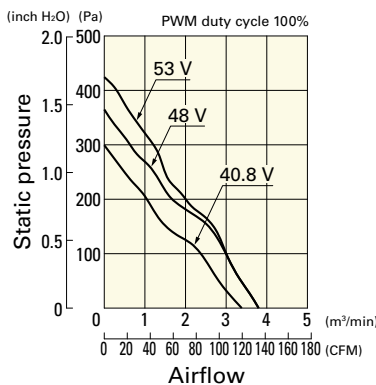

PWM duty - Speed characteristics example

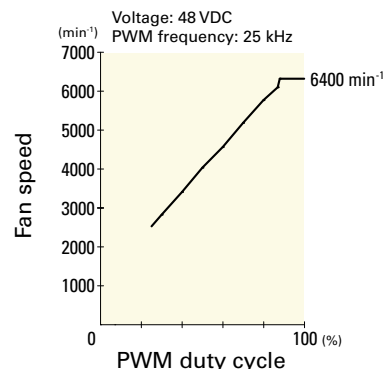

9GA1248P4S001 With pulse sensor with PWM control function

PWM duty cycle

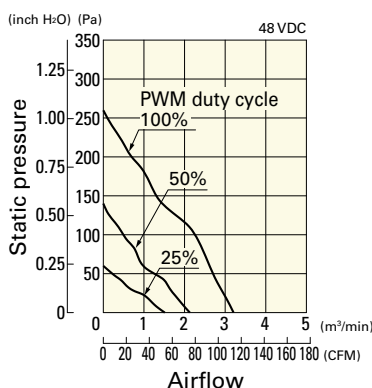

Operating voltage range

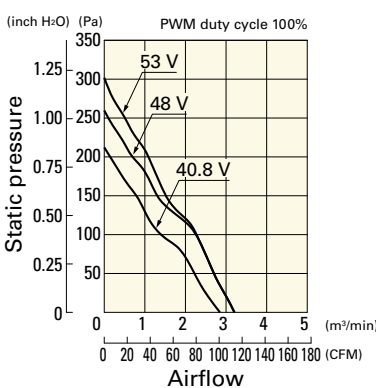

PWM duty - Speed characteristics example

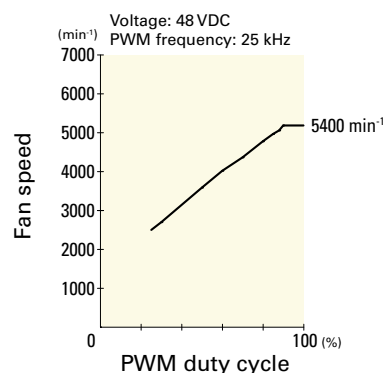

Airflow - Static Pressure Characteristics

9GA1212G4001 With pulse sensor

Operating voltage range

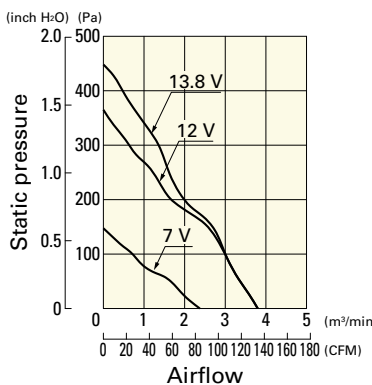

9GA1212S4001 With pulse sensor

Operating voltage range

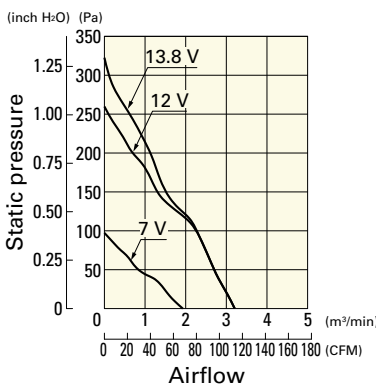

9GA1224G4001 With pulse sensor

Operating voltage range

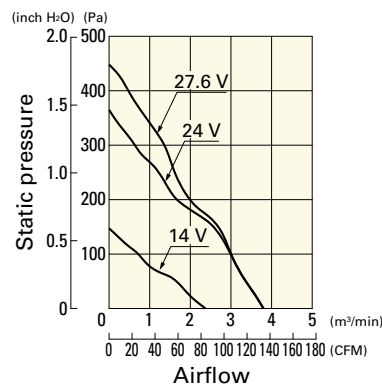

Airflow - Static Pressure Characteristics

9GA1224S4001 With pulse sensor

Operating voltage range

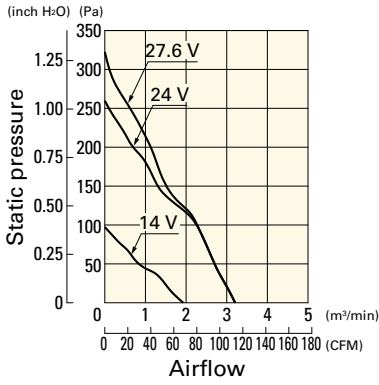

9GA1248G4001 With pulse sensor

Operating voltage range

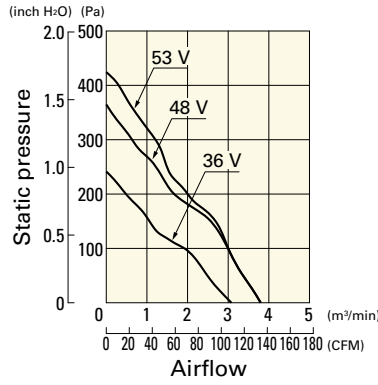

9GA1248S4001 With pulse sensor

Operating voltage range

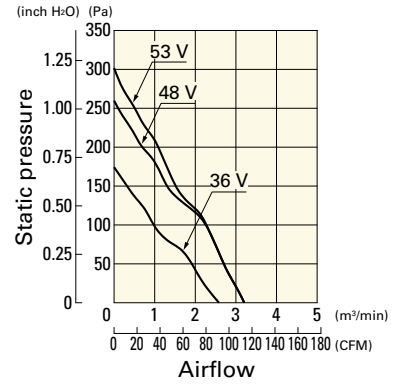

Dimensions (unit: mm) (With pulse sensor with PWM control function)

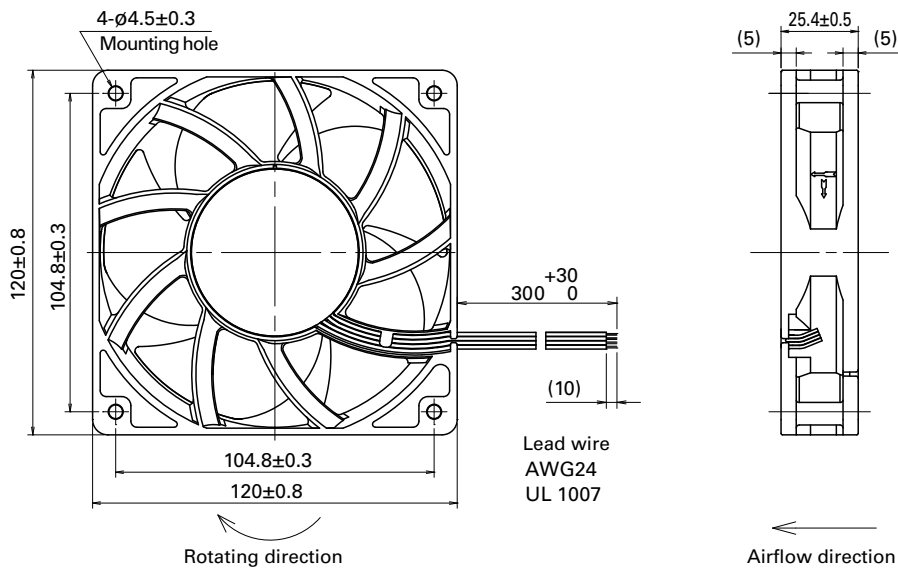

Reference Dimensions of Mounting Holes and Vent Opening (unit: mm)

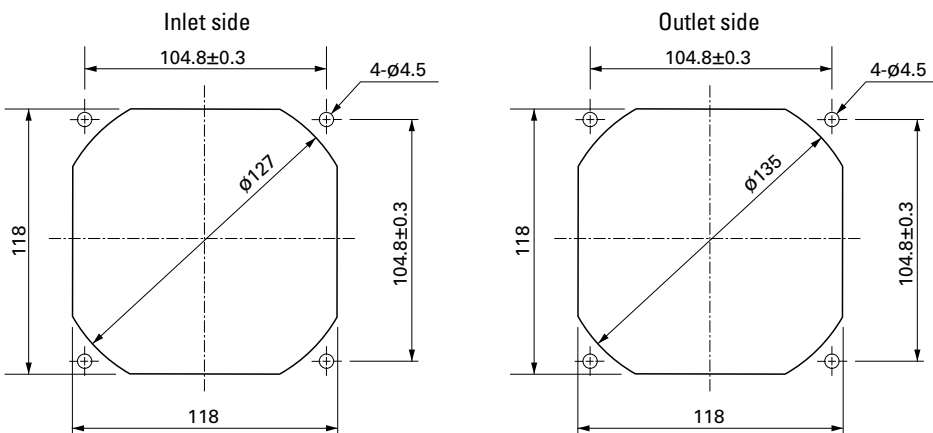

Options

Finger guards

page: p. 559

Model no.: 109-019E, 109-019K, 109-019C, 109-019H

Resin finger guards

page: p. 565

Model no.: 109-1000G

Resin filter kits

page: p. 566

Model no.: 109-1000F13 (13PPI), 109-1000F20 (20PPI), 109-1000F30 (30PPI), 109-1000F40 (40PPI)