

M378A1K43BB1
M378A1K43BB2
M378A2K43BB1
M391A2K43BB1

288pin Unbuffered DIMM based on 8Gb B-die

78FBGA with Lead-Free & Halogen-Free
(RoHS compliant)

datasheet

SAMSUNG ELECTRONICS RESERVES THE RIGHT TO CHANGE PRODUCTS, INFORMATION AND SPECIFICATIONS WITHOUT NOTICE.

Products and specifications discussed herein are for reference purposes only. All information discussed herein is provided on an "AS IS" basis, without warranties of any kind.

This document and all information discussed herein remain the sole and exclusive property of Samsung Electronics. No license of any patent, copyright, mask work, trademark or any other intellectual property right is granted by one party to the other party under this document, by implication, estoppel or otherwise.

Samsung products are not intended for use in life support, critical care, medical, safety equipment, or similar applications where product failure could result in loss of life or personal or physical harm, or any military or defense application, or any governmental procurement to which special terms or provisions may apply.

For updates or additional information about Samsung products, contact your nearest Samsung office.

All brand names, trademarks and registered trademarks belong to their respective owners.

© 2016 Samsung Electronics Co., Ltd. All rights reserved.

Revision History

<u>Revision No.</u>	<u>History</u>	<u>Draft Date</u>	<u>Remark</u>	<u>Editor</u>
1.0	- First SPEC release	Feb. 2015	-	J.Y.Lee
1.1	- Addition of VDDSPD tolerance on page 8 - Change of Function Block Diagram (without thermal sensor) on page 11	Mar. 2015	-	J.Y.Lee
1.2	- Deletion of "x64 DIMM Pin Configuration" - Correction of typo	Apr. 2015	-	J.Y.Lee
1.21	- Correction of typo	Apr. 2015	-	J.Y.Lee
1.3	- Addition of Module line up (M378A1K43BB1)	May. 2015	-	J.Y.Lee
1.31	- Correction of typo	May. 2015	-	J.Y.Lee
1.32	- Correction of typo	Jul. 2015	-	J.Y.Lee
1.4	- Change of VDDSPD tolerance on page 7	5th Nov. 2015	-	J.Y.Lee
1.5	- 1Rx8 2400 Jedec MDL gerber Change : 1->2 - Change of IDD value on page 26~28	4th Feb. 2016	-	J.Y.Lee
1.51	- Correction of typo	4th Mar. 2016	-	J.Y.Lee

Table Of Contents

288pin Unbuffered DIMM based on 8Gb B-die

1. DDR4 Unbuffered DIMM Ordering Information	4
2. Key Features	4
3. Address Configuration	4
4. Pin Description	5
5. Input/Output Functional Description	6
5.1 Address Mirroring	8
6. Function Block Diagram:	9
6.1 8GB, 1Gx64 Non ECC Module (Populated as 1 rank of x8 DDR4 SDRAMs)	9
6.2 16GB, 2Gx64 Non ECC Module (Populated as 2 ranks of x8 DDR4 SDRAMs)	11
6.3 16GB, 2Gx72 ECC Module (Populated as 2 ranks of x8 DDR4 SDRAMs)	13
7. Absolute Maximum Ratings	14
7.1 Absolute Maximum DC Ratings	14
8. AC & DC Operating Conditions	14
8.1 Recommended DC Operating Conditions	14
9. AC & DC Input Measurement Levels	15
9.1 AC & DC Logic Input Levels for Single-Ended Signals	15
9.2 AC and DC Input Measurement Levels : VREF Tolerances	15
9.3 AC and DC Logic Input Levels for Differential Signals	16
9.3.1. Differential Signals Definition	16
9.3.2. Differential Swing Requirements for Clock (CK _t - CK _c)	16
9.3.3. Single-ended Requirements for Differential Signals	17
9.4 Slew Rate Definitions	18
9.4.1. Slew Rate Definitions for Differential Input Signals (CK)	18
9.5 Differential Input Cross Point Voltage	19
9.6 Single-ended AC & DC Output Levels	20
9.7 Differential AC & DC Output Levels	20
9.8 Single-ended Output Slew Rate	20
9.9 Differential Output Slew Rate	21
9.10 Single-ended AC & DC Output Levels of Connectivity Test Mode	22
9.11 Test Load for Connectivity Test Mode Timing	22
10. DIMM IDD Specification Definition	23
11. IDD SPEC Table	26
12. Input/Output Capacitance	30
13. Electrical Characteristics and AC Timing	31
13.1 Speed Bins and CL, tRCD, tRP, tRC and tRAS for Corresponding Bin	31
13.2 Speed Bin Table Note	34
14. Timing Parameters by Speed Grade	35
15. Physical Dimensions	41
15.1 1Gx8 based 1Gx64 Module (1 Rank) - M378A1K43BB1	41
15.2 1Gx8 based 1Gx64 Module (1 Rank) - M378A1K43BB2	42
15.3 1Gx8 based 2Gx64 Module (2 Ranks) - M378A2K43BB1	43
15.4 1Gx8 based 2Gx72 Module (2 Ranks) - M391A2K43BB1	44

1. DDR4 Unbuffered DIMM Ordering Information

Part Number ²	Density	Organization	Component Composition ¹	Number of Rank	Height
M378A1K43BB1-CPB	8GB	1Gx64	1Gx8(K4A8G085WB-BCPB)*8	1	31.25mm
M378A1K43BB2-CRC	8GB	1Gx64	1Gx8(K4A8G085WB-BCRC)*8	1	31.25mm
M378A2K43BB1-CPB/RC	16GB	2Gx64	1Gx8(K4A8G085WB-BC##)*16	2	31.25mm
M391A2K43BB1-CPB/RC	16GB	2Gx72	1Gx8(K4A8G085WB-BC##)*18	2	31.25mm

NOTE :

1. "##" -PB/RC

2. PB(2133Mbps 15-15-15)/RC(2400Mbps 17-17-17)

- DDR4-2400(17-17-17) is backward compatible to DDR4-2133(15-15-15)

2. Key Features

Speed	DDR4-1600	DDR4-1866	DDR4-2133	DDR4-2400	Unit
	12-12-12	14-14-14	15-15-15	17-17-17	
tCK(min)	1.25	1.071	0.938	0.833	ns
CAS Latency	11	13	15	17	nCK
tRCD(min)	13.75	13.92	14.06	14.16	ns
tRP(min)	13.75	13.92	14.06	14.16	ns
tRAS(min)	35	34	33	32	ns
tRC(min)	48.75	47.92	47.06	46.16	ns

- JEDEC standard 1.2V ± 0.06V Power Supply
- V_{DDQ} = 1.2V ± 0.06V
- 800 MHz f_{CK} for 1600Mb/sec/pin, 933 MHz f_{CK} for 1866Mb/sec/pin, 1067MHz f_{CK} for 2133Mb/sec/pin, 1200MHz f_{CK} for 2400Mb/sec/pin
- 16 Banks (4 Bank Groups)
- Programmable CAS Latency: 10,11,12,13,14,15,16,17,18
- Programmable Additive Latency(Posted CAS) : 0, CL - 2, or CL - 1 clock
- Programmable CAS Write Latency(CWL) = 9,11 (DDR4-1600) , 10,12 (DDR4-1866) , 11,14 (DDR4-2133) and 12,16 (DDR4-2400)
- Burst Length: 8 , 4 with tCCD = 4 which does not allow seamless read or write [either On the fly using A12 or MRS]
- Bi-directional Differential Data Strobe
- On Die Termination using ODT pin
- Average Refresh Period 7.8us at lower then T_{CASE} 85°C, 3.9us at 85°C < T_{CASE} ≤ 95°C
- Asynchronous Reset

3. Address Configuration

Organization	Row Address	Column Address	Bank Address	Auto Precharge
1Gx8(8Gb) based Module	A0-A15	A0-A9	BA0-BA1	A10/AP

4. Pin Description

Pin Name	Description	Pin Name	Description
A0–A17 ¹	SDRAM address bus	SCL	I ² C serial bus clock for SPD-TSE
BA0, BA1	SDRAM bank select	SDA	I ² C serial bus data line for SPD-TSE
BG0, BG1	SDRAM bank group select	SA0–SA2	I ² C slave address select for SPD-TSE
RAS_n ²	SDRAM row address strobe	PARITY	SDRAM parity input
CAS_n ³	SDRAM column address strobe	VDD	SDRAM I/O and core power supply
WE_n ⁴	SDRAM write enable		
CS0_n, CS1_n	DIMM Rank Select Lines	12 V	Optional power Supply on socket but not used on UDIMM
CKE0, CKE1	SDRAM clock enable lines	VREFCA	
ODT0, ODT1	SDRAM on-die termination control lines	VSS	Power supply return (ground)
ACT_n	SDRAM activate	VDDSPD	Serial SPD-TSE positive power supply
DQ0–DQ63	DIMM memory data bus	ALERT_n	SDRAM ALERT_n
CB0–CB7	DIMM ECC check bits	VPP	SDRAM Supply
TDQS0_t–TDQS8_t TDQS0_c–TDQS8_c	Dummy loads for mixed populations of x4 based and x8 based RDIMMs. Not used on UDIMMs.		
DQS0_t–DQS8_t	SDRAM data strobes (positive line of differential pair)		
DQS0_c–DQS8_c	SDRAM data strobes (negative line of differential pair)	RESET_n	Set DRAMs to a Known State
DM0_n–DM8_n, DBI0_n–DBI8_n	SDRAM data masks/data bus inversion (x8-based x64 DIMMs)	EVENT_n	SPD signals a thermal event has occurred
CK0_t, CK1_t	SDRAM clocks (positive line of differential pair)	VTT	SDRAM I/O termination supply
CK0_c, CK1_c	SDRAM clocks (negative line of differential pair)	RFU	Reserved for future use

NOTE :

1. Address A17 is not valid for x8 and x16 based SDRAMs. For UDIMMs this connection pin is NC.
2. RAS_n is a multiplexed function with A16.
3. CAS_n is a multiplexed function with A15.
4. WE_n is a multiplexed function with A14.

[Table 1] Temperature Sensor Characteristics

Grade	Range	Temperature Sensor Accuracy			Units	NOTE
		Min.	Typ.	Max.		
B	75 < Ta < 95	-	+/- 0.5	+/- 1.0	°C	-
	40 < Ta < 125	-	+/- 1.0	+/- 2.0		-
	-20 < Ta < 125	-	+/- 2.0	+/- 3.0		-
Resolution		0.25			°C /LSB	-

5. Input/Output Functional Description

Symbol	Type	Function
CK0_t, CK0_c, CK1_t, CK1_c	Input	Clock: CK_t and CK_c are differential clock inputs. All address and control input signals are sampled on the crossing of the positive edge of CK_t and negative edge of CK_c.
CKE0, CKE1	Input	Clock Enable: CKE HIGH activates and CKE LOW deactivates internal clock signals and device input buffers and output drivers. Taking CKE LOW provides Precharge Power-Down and Self-Refresh operation (all banks idle), or Active Power-Down (row Active in any bank). CKE is synchronous for Self-Refresh exit. After VREFCA and Internal DQ Vref have become stable during the power on and initialization sequence, they must be maintained during all operations (including Self-Refresh). CKE must be maintained high throughout read and write accesses. Input buffers, excluding CK_t, CK_c, ODT and CKE, are disabled during power-down. Input buffers, excluding CKE, are disabled during Self-Refresh.
CS0_n, CS1_n, CS2_n, CS3_n	Input	Chip Select: All commands are masked when CS_n is registered HIGH. CS_n provides for external Rank selection on systems with multiple Ranks. CS_n is considered part of the command code. CS2_n and CS3_n are not used on UDIMMs
C0, C1, C2	Input	Chip ID: Chip ID is only used for 3DS for 2,4,8 high stack via TSV to select each slice of stacked component. Chip ID is considered part of the command code. Not used on UDIMMs.
ODT0, ODT1	Input	On Die Termination: ODT (registered HIGH) enables RTT_NOM termination resistance internal to the DDR4 SDRAM. When enabled, ODT is only applied to each DQ, DQS_t, DQS_c and DM_n/DBI_n/TDQS_t, NU/TDQS_c (When TDQS is enabled via Mode Register A11=1 in MR1) signal for x8 configurations. For x16 configuration ODT is applied to each DQ, DQSU_t, DQSU_c, DQSL_t, DQSL_c, DMU_n, and DML_n signal. The ODT pin will be ignored if MR1 is programmed to disable RTT_NOM.
ACT_n	Input	Activation Command Input: ACT_n defines the Activation command being entered along with CS_n. The input into RAS_n/A16, CAS_n/A15 and WE_n/A14 will be considered as Row Address A16, A15 and A14.
RAS_n/A16. CAS_n/A15. WE_n/A14	Input	Command Inputs: RAS_n/A16, CAS_n/A15 and WE_n/A14 (along with CS_n) define the command being entered. Those pins have multi function. For example, for activation with ACT_n Low, these are Addresses like A16, A15 and A14 but for non-activation command with ACT_n High, these are Command pins for Read, Write and other command defined in command truth table.
DM_n/DBI_n/ TDQS_t, (DMU_n/ DBIU_n), (DML_n/ DBIL_n)	Input/ Output	Input Data Mask and Data Bus Inversion: DM_n is an input mask signal for write data. Input data is masked when DM_n is sampled LOW coincident with that input data during a Write access. DBI_n is an input/output identifying whether to store/output the true or inverted data. If DBI_n is LOW, the data will be stored/output after inversion inside the DDR4 SDRAM and not inverted if DBI_n is HIGH. TDQS is only supported in x8 SDRAM configurations. TDQS is not valid for UDIMMs.
BG0 - BG1	Input	Bank Group Inputs: BG0 - BG1 define which bank group an Active, Read, Write or Precharge command is being applied. BG0 also determines which mode register is to be accessed during a MRS cycle. x4/x8 SDRAM configurations have BG0 and BG1. x16 based SDRAMs only have BG0.
BA0 - BA1	Input	Bank Address Inputs: BA0 - BA1 define to which bank an Active, Read, Write or Precharge command is being applied. Bank address also determines which mode register is to be accessed during a MRS cycle.
A0 - A17	Input	Address Inputs: Provide the row address for ACTIVATE Commands and the column address for Read/Write commands to select one location out of the memory array in the respective bank. A10/AP, A12/BC_n, RAS_n/A16, CAS_n/A15 and WE_n/A14 have additional functions. See other rows. The address inputs also provide the op-code during Mode Register Set commands. A17 is only defined for the x4 SDRAM configuration.
A10 / AP	Input	Auto-precharge: A10 is sampled during Read/Write commands to determine whether Autoprecharge should be performed to the accessed bank after the Read/Write operation. (HIGH: Autoprecharge; LOW: no Autoprecharge). A10 is sampled during a Precharge command to determine whether the Precharge applies to one bank (A10 LOW) or all banks (A10 HIGH). If only one bank is to be precharged, the bank is selected by bank addresses.
A12 / BC_n	Input	Burst Chop: A12/BC_n is sampled during Read and Write commands to determine if burst chop (on-the-fly) will be performed. (HIGH, no burst chop; LOW: burst chopped). See command truth table for details.
RESET_n	CMOS Input	Active Low Asynchronous Reset: Reset is active when RESET_n is LOW, and inactive when RESET_n is HIGH. RESET_n must be HIGH during normal operation.
DQ	Input/ Output	Data Input/ Output: Bi-directional data bus. If CRC is enabled via Mode register then CRC code is added at the end of Data Burst. Any DQ from DQ0-DQ3 may indicate the internal Vref level during test via Mode Register Setting MR4 A4=High. Refer to vendor specific data sheets to determine which DQ is used.
DQS_t, DQS_c, DQSU_t, DQSU_c, DQSL_t, DQSL_c	Input/ Output	Data Strobe: output with read data, input with write data. Edge-aligned with read data, centered in write data. For the x16, DQSL corresponds to the data on DQL0-DQL7; DQSU corresponds to the data on DQU0-DQU7. The data strobe DQS_t, DQSL_t and DQSU_t are paired with differential signals DQS_c, DQSL_c, and DQSU_c, respectively, to provide differential pair signaling to the system during reads and writes. DDR4 SDRAM supports differential data strobe only and does not support single-ended.

TDQS_t, TDQS_c	Output	Termination Data Strobe: TDQS_t/TDQS_c are not valid for UDIMMs.
PARITY	Input	Command and Address Parity Input: DDR4 Supports Even Parity check in DRAMs with MR setting. Once it's enabled via Register in MR5, then DRAM calculates Parity with ACT_n, RAS_n/A16, CAS_n/A15, WE_n/A14, BG0-BG1, BA0-BA1, A16-A0. Input parity should be maintained at the rising edge of the clock and at the same time with command & address with CS_n LOW
ALERT_n	Output	Alert: It has multi functions such as CRC error flag, Command and Address Parity error flag as Output signal. If there is error in CRC, then ALERT_n goes LOW for the period time interval and goes back HIGH. If there is error in Command Address Parity Check, then ALERT_n goes LOW for relatively long period until on going DRAM internal recovery transaction is complete. During Connectivity Test mode this pin functions as an input. Using this signal or not is dependent on the system.
RFU		Reserved for Future Use. No on DIMM electrical connection is present.
NC		No Connect: No on DIMM electrical connection is present.
VDD ¹	Supply	Power Supply: 1.2 V +/- 0.06 V
VSS	Supply	Ground
VPP	Supply	DRAM Activating Power Supply: 2.5V (2.375V min, 2.75V max)
VTT ²	Supply	Power Supply for termination of Address, Command and Control, VDD/2.
12 V	Supply	12 V supply not used on UDIMMs.
VDDSPD	Supply	Power supply used to power the I2C bus on the SPD-TSE 2.5V or 3.3V.
VREFCA	Supply	Reference voltage for CA

NOTE :

1. For PC4 VDD 1.2 V. For PC4L VDD is TBD.
2. For PC4 VTT is 0.60 V. For PC4L VTT is TBD.

5.1 Address Mirroring

DDR4 two rank UDIMMs will use address mirroring. DRAMs for even ranks will be placed on the front side of the module. DRAMs for odd ranks will be placed on the back side of the module. Wiring of the address bus will be as defined in Table 2.

Since the cross-wired pins have no secondary functions, there is no problem in normal operation. Any data written is read the same way. There are limitations however. When writing to the internal registers with a "load mode" operation, the specific address is required. This requires the controller to know if the rank is mirrored or not. There is a bit assignment in the SPD that indicates whether the module has been designed with the mirrored feature or not. See the DDR4 SPD specification for these details. The controller must read the SPD and have the capability of de-mirroring the address when accessing the odd ranks.

[Table 2] DIMM Wiring Definition for Address Mirroring

Signal Name	DRAM Ball Label		Comment
	Connector	Even Rank	
A0	A0	A0	
A1	A1	A1	
A2	A2	A2	
A3	A3	A4	
A4	A4	A3	
A5	A5	A6	
A6	A6	A5	
A7	A7	A8	
A8	A8	A7	
A9	A9	A9	
A10/AP	A10/AP	A10/AP	
A11	A11	A13	
A12/BC_n	A12/BC_n	A12/BC_n	
A13	A13	A11	
A14/WE_n	A14/WE_n	A14/WE_n	
A15/CAS_n	A15/CAS_n	A15/CAS_n	
A16/RAS_n	A16/RAS_n	A16/RAS_n	
A17	A17	A17	Not valid for x8 and x16 DRAM components up to 16 Gb.
BA0	BA0	BA1	
BA1	BA1	BA0	
BG0	BG0	BG1	BG1 is not valid for x16 DRAM components. For x16 DRAM components signal BG0 will be wired to DRAM ball BG0 for both ranks.
BG1	BG1	BG0	BG1 is not valid for x16 DRAM components. For x16 DRAM components signal BG0 will be wired to DRAM ball BG0 for both ranks.

6. Function Block Diagram:

6.1 8GB, 1Gx64 Non ECC Module (Populated as 1 rank of x8 DDR4 SDRAMs)

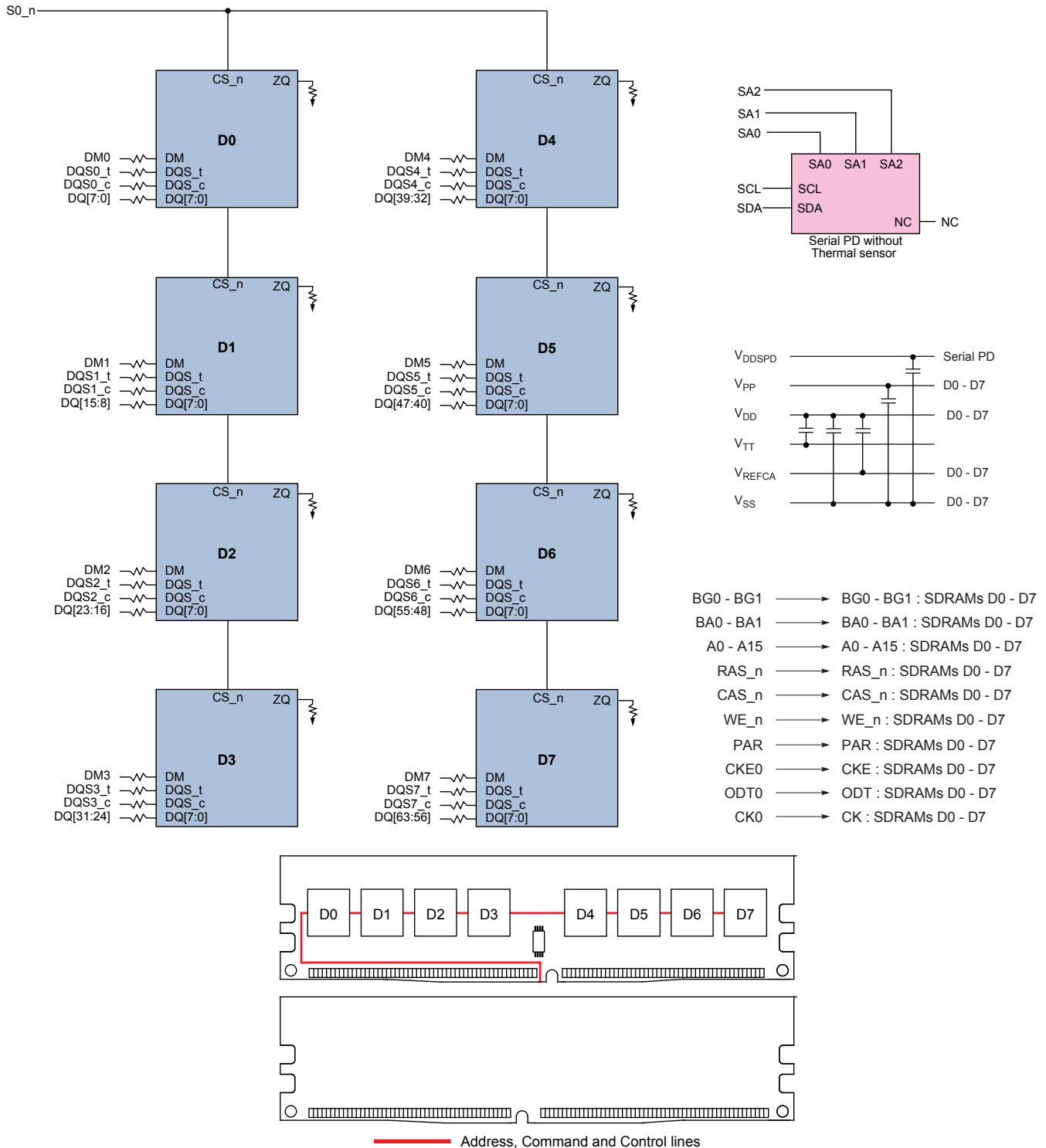

NOTE :

1. Unless otherwise noted, resistor values are $15\Omega \pm 5\%$.
2. See the Net Structure diagrams for all resistors associated with the command, address and control bus.
3. ZQ resistors are $240\Omega \pm 1\%$. For all other resistor values refer to the appropriate wiring diagram.

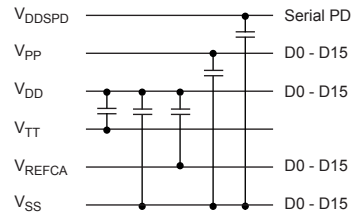
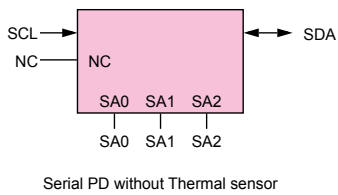
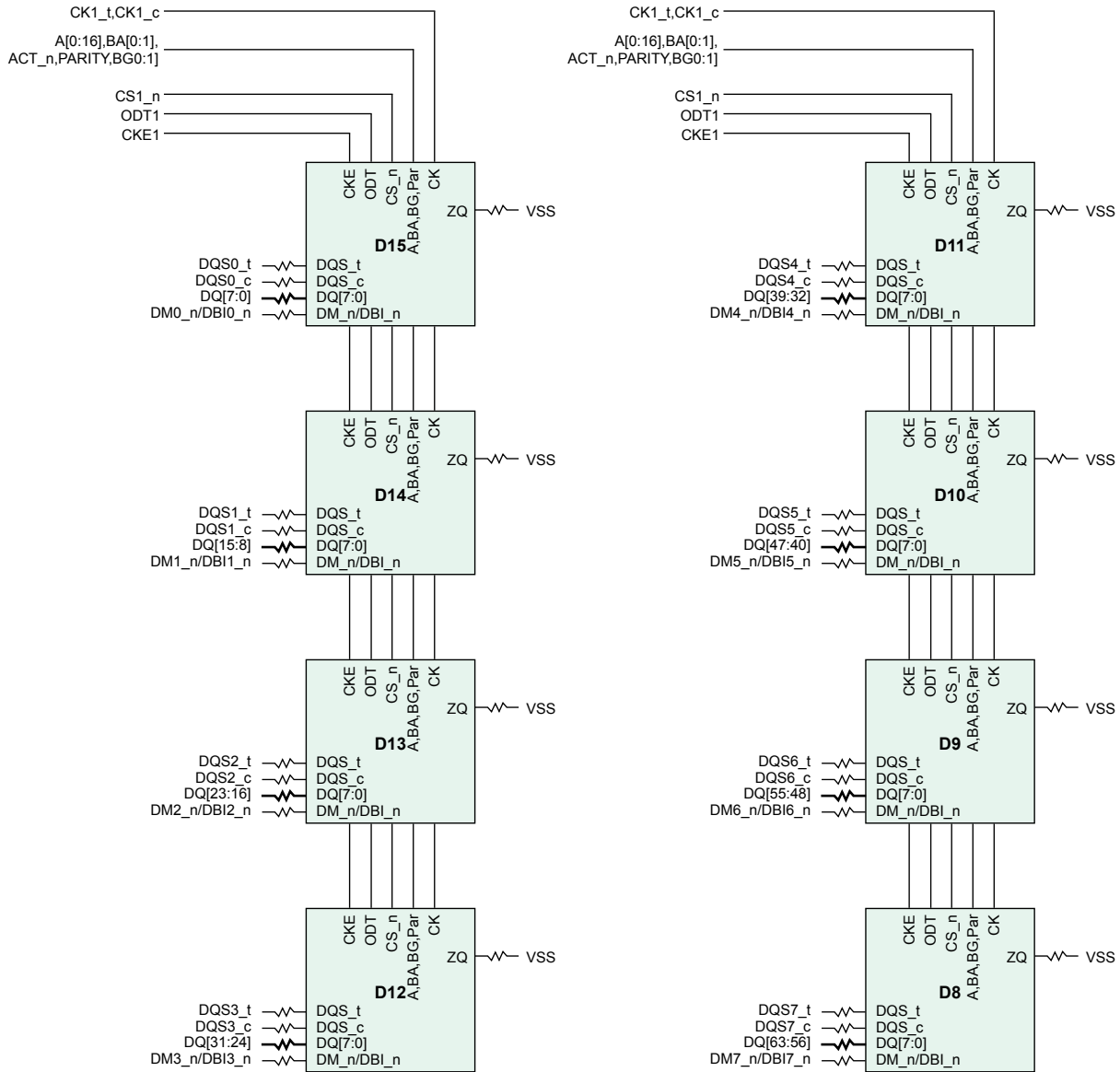

NOTE :

1. Unless otherwise noted, resistor values are $15\Omega \pm 5\%$.
2. ZQ resistors are $240\Omega \pm 1\%$. For all other resistor values refer to the appropriate wiring diagram.
3. For part 2 of 2 the DQ resistors are shown for simplicity but are the same physical components as shown on part 1 of 2.
4. EVENT_n is wired on this design. A standalone SPD may be used as well. No wiring changes are required.

6.2 16GB, 2Gx64 Non ECC Module (Populated as 2 ranks of x8 DDR4 SDRAMs)

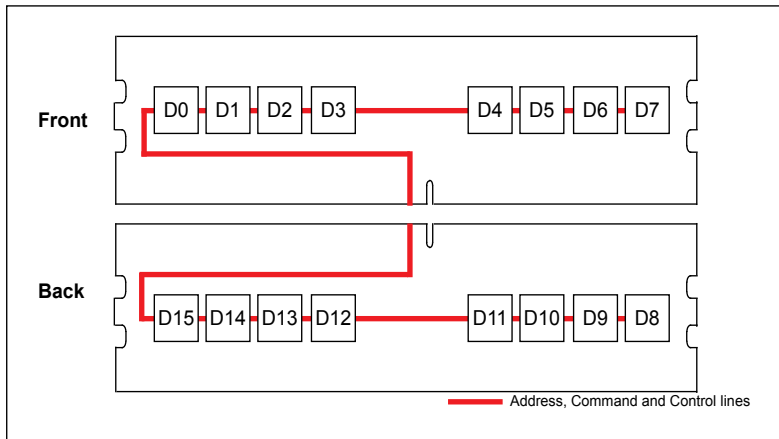
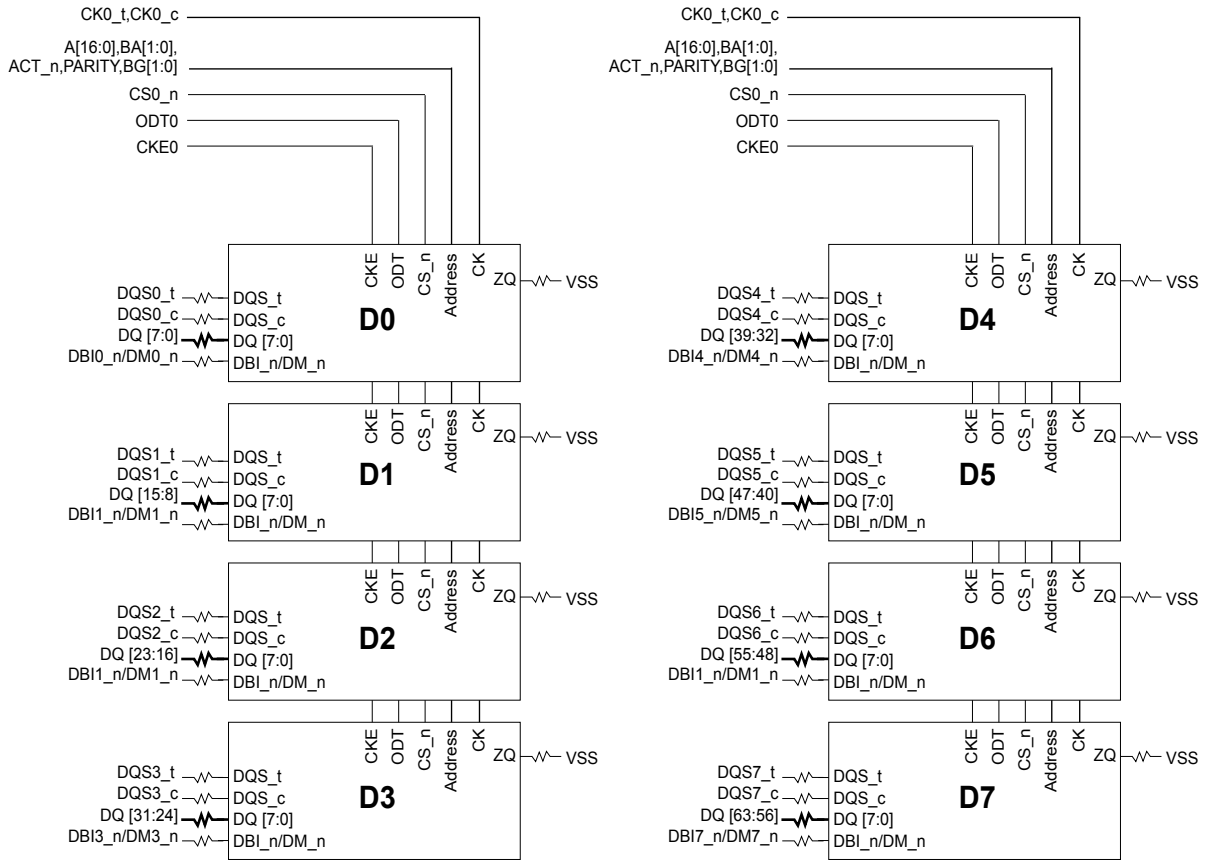

NOTE :

1. Unless otherwise noted, resistor values are $15\Omega \pm 5\%$.
2. ZQ resistors are $240\Omega \pm 1\%$. For all other resistor values refer to the appropriate wiring diagram.

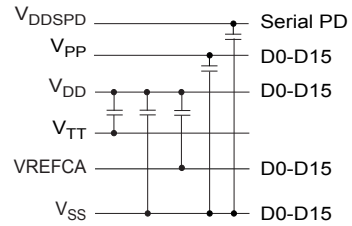
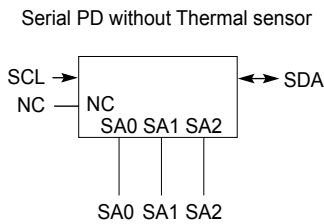
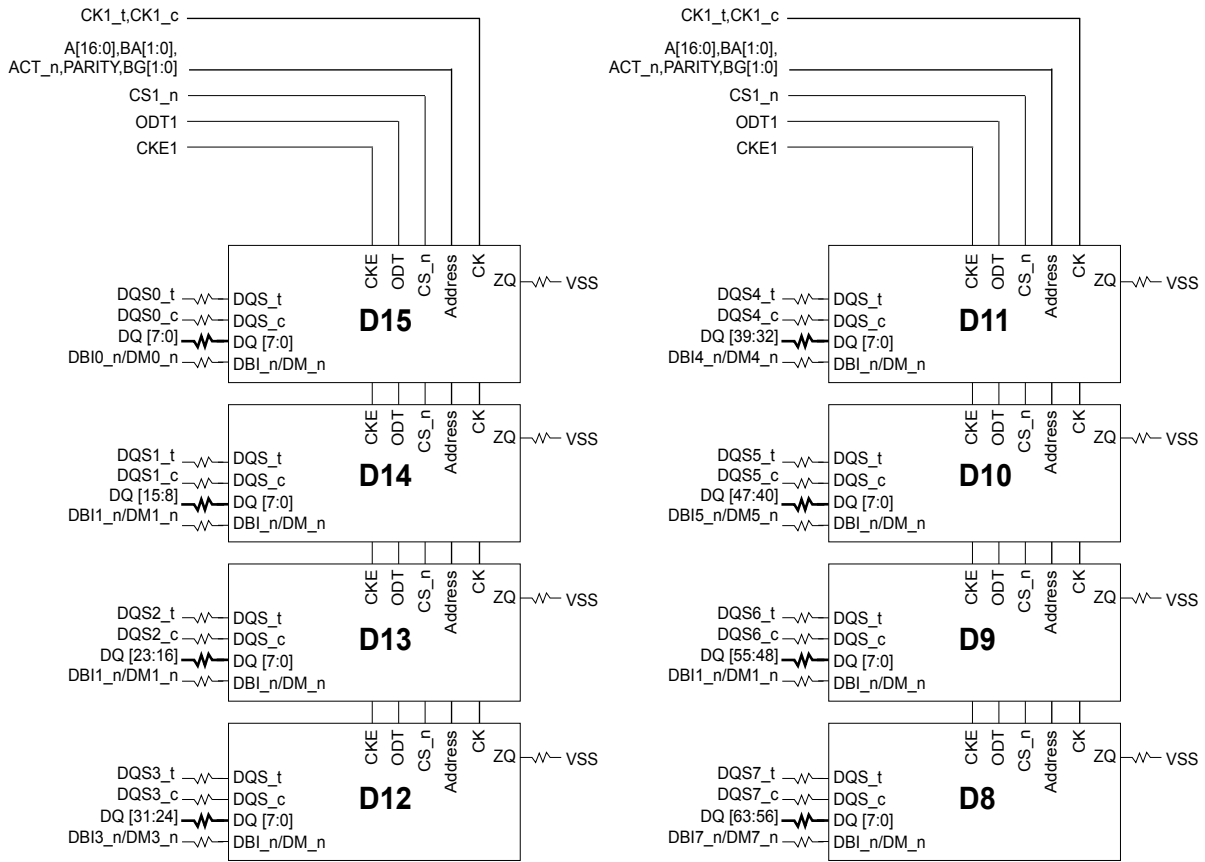

NOTE :

1. Unless otherwise noted, resistor values are 15W ± 5%.
2. ZQ resistors are 240W ± 1%. For all other resistor values refer to the appropriate wiring diagram.
3. For part 2 of 2 the DQ resistors are shown for simplicity but are the same physical components as shown on part 1 of 2.
4. EVENT_n is wired on this design. A standalone SPD may be used as well. No wiring changes are required.

6.3 16GB, 2Gx72 ECC Module (Populated as 2 ranks of x8 DDR4 SDRAMs)

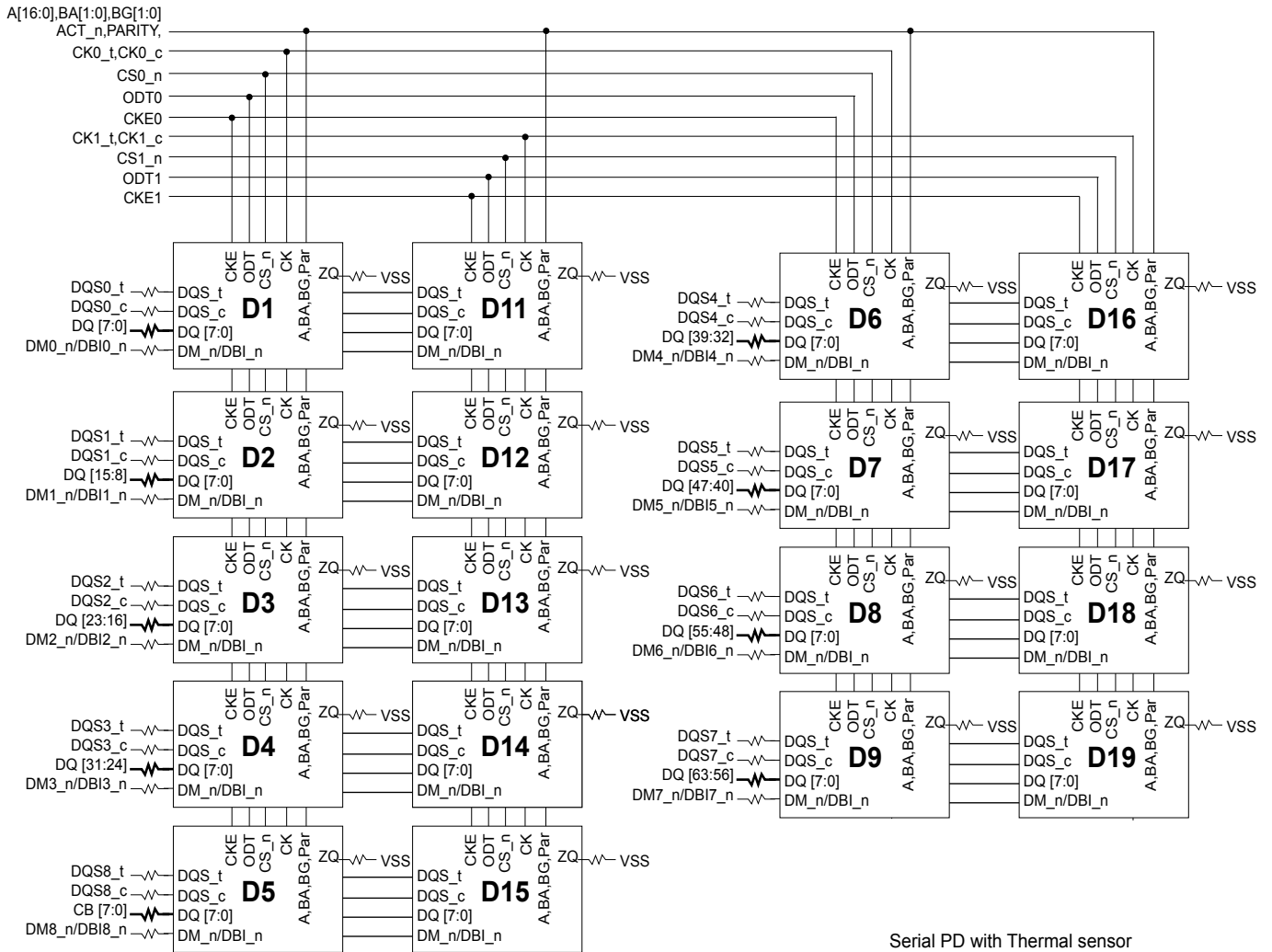

Serial PD with Thermal sensor

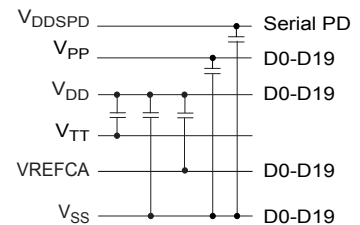
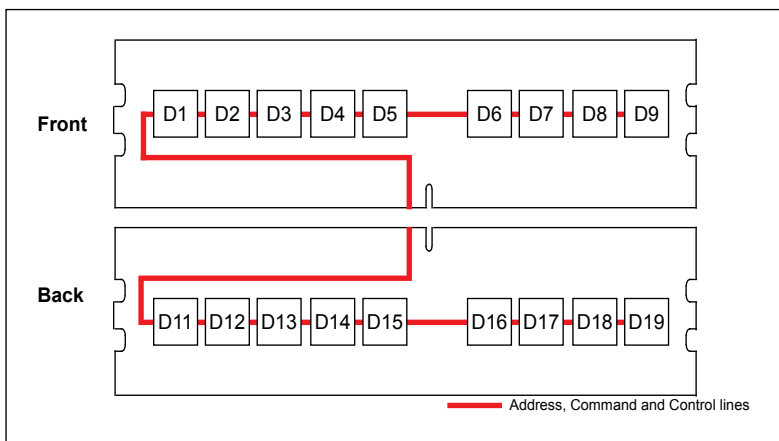
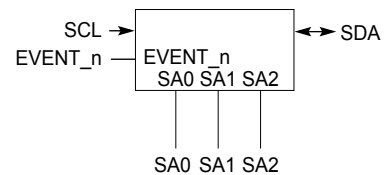

NOTE :

1. Unless otherwise noted, resistor values are 15Ω ± 5%.
2. ZQ resistors are 240Ω ± 1%. For all other resistor values refer to the appropriate wiring diagram.



7. Absolute Maximum Ratings

7.1 Absolute Maximum DC Ratings

[Table 3] Absolute Maximum DC Ratings

Symbol	Parameter	Rating	Units	NOTE
VDD	Voltage on VDD pin relative to Vss	-0.3 ~ 1.5	V	1,3
VDDQ	Voltage on VDDQ pin relative to Vss	-0.3 ~ 1.5	V	1,3
VPP	Voltage on VPP pin relative to Vss	-0.3 ~ 3.0	V	4
V _{IN} , V _{OUT}	Voltage on any pin except VREFCA to Vss	-0.3 ~ 1.5	V	1,3
T _{STG}	Storage Temperature	-55 to +100	°C	1,2

NOTE :

- Stresses greater than those listed under "Absolute Maximum Ratings" may cause permanent damage to the device. This is a stress rating only and functional operation of the device at these or any other conditions above those indicated in the operational sections of this specification is not implied. Exposure to absolute maximum rating conditions for extended periods may affect reliability
- Storage Temperature is the case surface temperature on the center/top side of the DRAM. For the measurement conditions, please refer to JESD51-2 standard.
- VDD and VDDQ must be within 300 mV of each other at all times; and VREFCA must be not greater than 0.6 x VDDQ, When VDD and VDDQ are less than 500 mV; VREFCA may be equal to or less than 300 mV
- VPP must be equal or greater than VDD/VDDQ at all times.

8. AC & DC Operating Conditions

8.1 Recommended DC Operating Conditions

[Table 4] Recommended DC Operating Conditions

Symbol	Parameter	Rating			Unit	NOTE
		Min.	Typ.	Max.		
VDD	Supply Voltage	1.14	1.2	1.26	V	1,2,3
VDDQ	Supply Voltage for Output	1.14	1.2	1.26	V	1,2,3
VPP	Peak-to-Peak Voltage	2.375	2.5	2.75	V	3

NOTE:

- Under all conditions V_{DDQ} must be less than or equal to V_{DD}.
- V_{DDQ} tracks with V_{DD}. AC parameters are measured with V_{DD} and V_{DDQ} tied together.
- DC bandwidth is limited to 20MHz.

9. AC & DC Input Measurement Levels

9.1 AC & DC Logic Input Levels for Single-Ended Signals

[Table 5] Single-ended AC & DC Input Levels for Command and Address

Symbol	Parameter	DDR4-1600/1866/2133/2400		Unit	NOTE
		Min.	Max.		
$V_{IH,CA}(DC75)$	DC input logic high	$V_{REFCA} + 0.075$	V_{DD}	V	
$V_{IL,CA}(DC75)$	DC input logic low	V_{SS}	$V_{REFCA} - 0.075$	V	
$V_{IH,CA}(AC100)$	AC input logic high	$V_{REF} + 0.1$	Note 2	V	1
$V_{IL,CA}(AC100)$	AC input logic low	Note 2	$V_{REF} - 0.1$	V	1
$V_{REFCA}(DC)$	Reference Voltage for ADD, CMD inputs	$0.49 \cdot V_{DD}$	$0.51 \cdot V_{DD}$	V	2,3

NOTE :

1. See "Overshoot and Undershoot Specifications" on section.
2. The AC peak noise on V_{REFCA} may not allow V_{REFCA} to deviate from $V_{REFCA}(DC)$ by more than $\pm 1\%$ V_{DD} (for reference : approx. $\pm 12mV$)
3. For reference : approx. $V_{DD}/2 \pm 12mV$

9.2 AC and DC Input Measurement Levels : V_{REF} Tolerances.

The DC-tolerance limits and ac-noise limits for the reference voltages V_{REFCA} is illustrated in Figure 1. It shows a valid reference voltage $V_{REF}(t)$ as a function of time. (V_{REF} stands for V_{REFCA}).

$V_{REF}(DC)$ is the linear average of $V_{REF}(t)$ over a very long period of time (e.g. 1 sec). This average has to meet the min/max requirement in Table X. Furthermore $V_{REF}(t)$ may temporarily deviate from $V_{REF}(DC)$ by no more than $\pm 1\%$ V_{DD} .

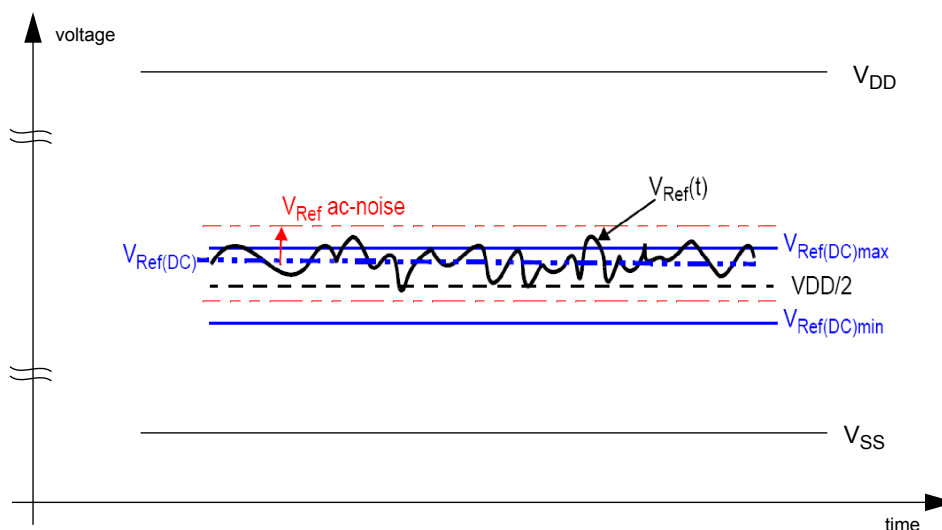

Figure 1. Illustration of $V_{REF}(DC)$ tolerance and V_{REF} AC-noise limits

The voltage levels for setup and hold time measurements $V_{IH}(AC)$, $V_{IH}(DC)$, $V_{IL}(AC)$ and $V_{IL}(DC)$ are dependent on V_{REF} .

" V_{REF} " shall be understood as $V_{REF}(DC)$, as defined in Figure 1.

This clarifies, that DC-variations of V_{REF} affect the absolute voltage a signal has to reach to achieve a valid high or low level and therefore the time to which setup and hold is measured. System timing and voltage budgets need to account for $V_{REF}(DC)$ deviations from the optimum position within the data-eye of the input signals.

This also clarifies that the DRAM setup/hold specification and derating values need to include time and voltage associated with V_{REF} AC-noise. Timing and voltage effects due to AC-noise on V_{REF} up to the specified limit ($\pm 1\%$ of V_{DD}) are included in DRAM timings and their associated deratings.

9.3 AC and DC Logic Input Levels for Differential Signals

9.3.1 Differential Signals Definition

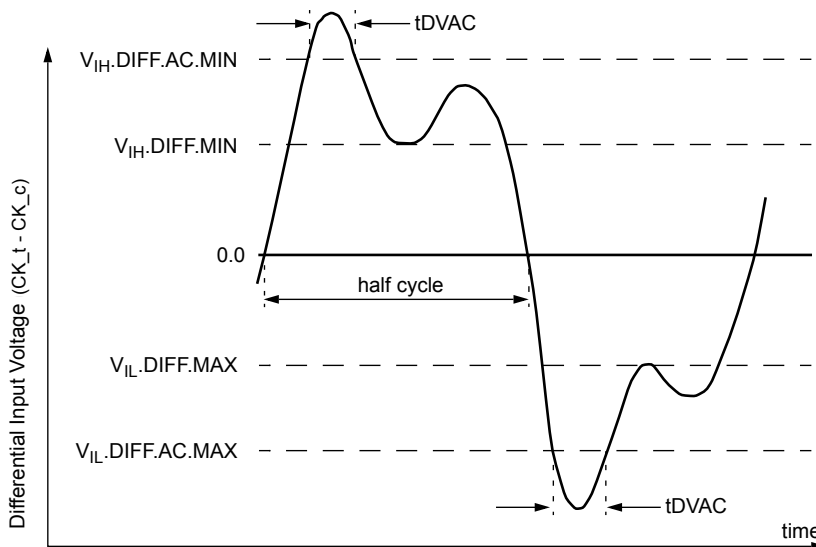

Figure 2. Definition of differential ac-swing and “time above ac-level” tDVAC

NOTE :

1. Differential signal rising edge from V_{IL.DIFF.MAX} to V_{IH.DIFF.MIN} must be monotonic slope.
2. Differential signal falling edge from V_{IH.DIFF.MIN} to V_{IL.DIFF.MAX} must be monotonic slope.

9.3.2 Differential Swing Requirements for Clock (CK_t - CK_c)

[Table 6] Differential AC and DC Input Levels

Symbol	Parameter	DDR4 -1600/1866/2133		DDR4 -2400		unit	NOTE
		min	max	min	max		
V _{IHdiff}	differential input high	+0.150	NOTE 3	TBD	NOTE 3	V	1
V _{ILdiff}	differential input low	NOTE 3	-0.150	NOTE 3	TBD	V	1
V _{IHdiff(AC)}	differential input high ac	2 x (V _{IH(AC)} - V _{REF})	NOTE 3	2 x (V _{IH(AC)} - V _{REF})	NOTE 3	V	2
V _{ILdiff(AC)}	differential input low ac	NOTE 3	2 x (V _{IL(AC)} - V _{REF})	NOTE 3	2 x (V _{IL(AC)} - V _{REF})	V	2

NOTE:

1. Used to define a differential signal slew-rate.
2. for CK_t - CK_c use V_{IH,CA}/V_{IL,CA(AC)} of ADD/CMD and V_{REFCA};
3. These values are not defined; however, the differential signals CK_t - CK_c, need to be within the respective limits (V_{IH,CA}(DC) max, V_{IL,CA}(DC)min) for single-ended signals as well as the limitations for overshoot and undershoot.

[Table 7] Allowed Time Before Ringback (tDVAC) for CK_t - CK_c

Slew Rate [V/ns]	tDVAC [ps] @ V _{IH/Ldiff(AC)} = 200mV	
	min	max
> 4.0	120	-
4.0	115	-
3.0	110	-
2.0	105	-
1.8	100	-
1.6	95	-
1.4	90	-
1.2	85	-
1.0	80	-
< 1.0	80	-

9.3.3 Single-ended Requirements for Differential Signals

Each individual component of a differential signal (CK_t, CK_c) has also to comply with certain requirements for single-ended signals.

CK_t and CK_c have to approximately reach V_{SEH}min / V_{SEL}max (approximately equal to the ac-levels (V_{IH}.CA(AC) / V_{IL}.CA(AC)) for ADD/CMD signals) in every half-cycle.

Note that the applicable ac-levels for ADD/CMD might be different per speed-bin etc. E.g., if Different value than V_{IH}.CA(AC100)/V_{IL}.CA(AC100) is used for ADD/CMD signals, then these ac-levels apply also for the single-ended signals CK_t and CK_c

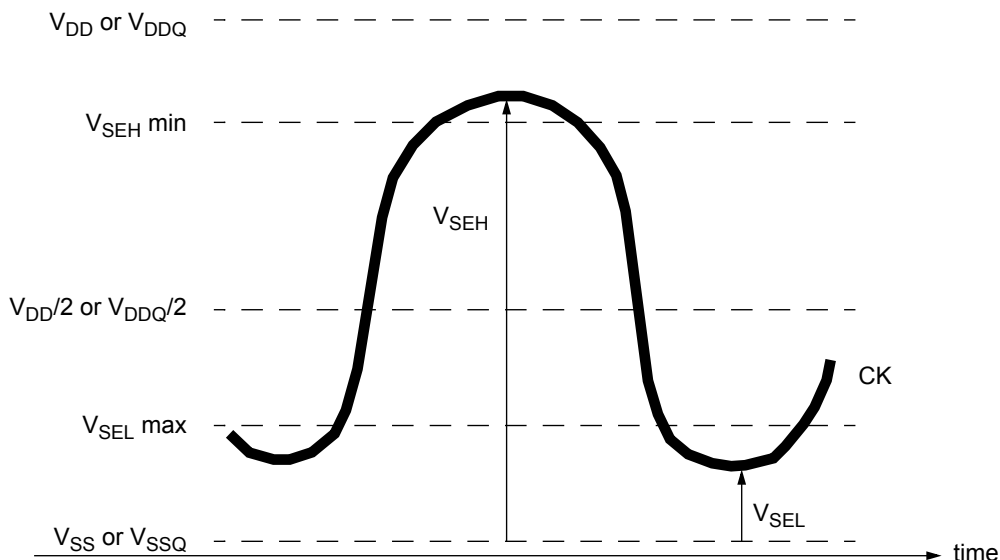

Figure 3. Single-ended requirement for differential signals.

Note that, while ADD/CMD signal requirements are with respect to V_{ref}CA, the single-ended components of differential signals have a requirement with respect to VDD / 2; this is nominally the same. The transition of single-ended signals through the ac-levels is used to measure setup time. For single-ended components of differential signals the requirement to reach V_{SEL}max, V_{SEH}min has no bearing on timing, but adds a restriction on the common mode characteristics of these signals.

[Table 8] Single-ended Levels for CK_t, CK_c

Symbol	Parameter	DDR4-1600/1866/2133		DDR4-2400		Unit	NOTE
		Min	Max	Min	Max		
V _{SEH}	Single-ended high-level for CK _t , CK _c	(VDD/2)+0.100	NOTE3	TBD	NOTE3	V	1, 2
V _{SEL}	Single-ended low-level for CK _t , CK _c	NOTE3	(VDD/2)-0.100	NOTE3	TBD	V	1, 2

- NOTE :**
1. For CK_t - CK_c use V_{IH}.CA/V_{IL}.CA(AC) of ADD/CMD;
 2. V_{IH}(AC)/V_{IL}(AC) for ADD/CMD is based on V_{REF}CA;
 3. These values are not defined, however the single-ended signals CK_t - CK_c need to be within the respective limits (V_{IH}.CA(DC) max, V_{IL}.CA(DC)min) for single-ended signals as well as the limitations for overshoot and undershoot.

9.4 Slew Rate Definitions

9.4.1 Slew Rate Definitions for Differential Input Signals (CK)

[Table 9] Differential Input Slew Rate Definition

Description			Defined by
	from	to	
Differential input slew rate for rising edge(CK_t - CK_c)	$V_{ILdiffmax}$	$V_{IHdiffmin}$	$[V_{IHdiffmin} - V_{ILdiffmax}] / \Delta TR_{diff}$
Differential input slew rate for falling edge(CK_t - CK_c)	$V_{IHdiffmin}$	$V_{ILdiffmax}$	$[V_{IHdiffmin} - V_{ILdiffmax}] / \Delta TF_{diff}$

NOTE: The differential signal (i.e.,CK_t - CK_c) must be linear between these thresholds.

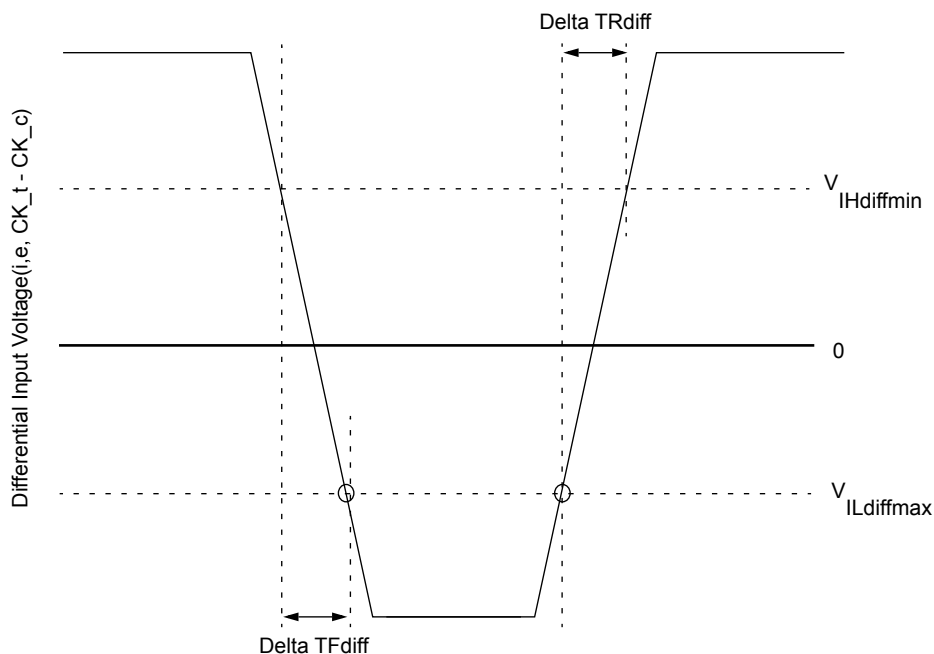

Figure 4. Differential Input Slew Rate Definition for CK_t, CK_c

9.5 Differential Input Cross Point Voltage

To guarantee tight setup and hold times as well as output skew parameters with respect to clock, each cross point voltage of differential input signals (CK_t, CK_c) must meet the requirements in Table. The differential input cross point voltage VIX is measured from the actual cross point of true and complement signals to the midlevel between of VDD and VSS.

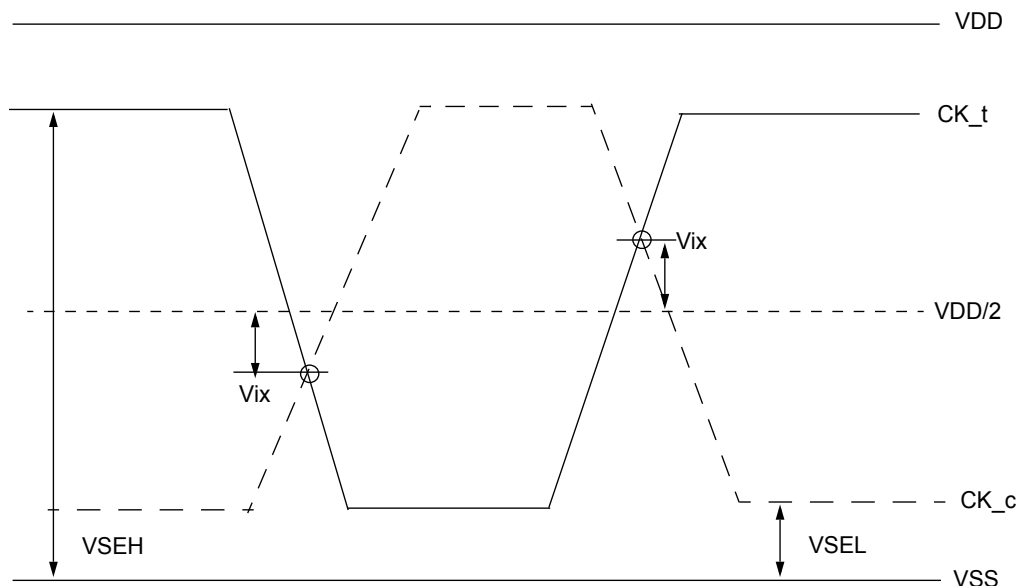

Figure 5. Vix Definition (CK)

[Table 10] Cross Point Voltage for Differential Input Signals (CK)

Symbol	Parameter	DDR4-1600/1866/2133			
		min		max	
-	Area of VSEH, VSEL	VSEL ≤ VDD/2 - 145mV	VDD/2 - 145mV ≤ VSEL ≤ VDD/2 - 100mV	VDD/2 + 100mV ≤ VSEH ≤ VDD/2 + 145mV	VDD/2 + 145mV ≤ VSEH
VIX(CK)	Differential Input Cross Point Voltage relative to VDD/2 for CK _t , CK _c	-120mV	-(VDD/2 - VSEL) + 25mV	(VSEH - VDD/2) - 25mV	120mV

Symbol	Parameter	DDR4-2400			
		min		max	
-	Area of VSEH, VSEL	TBD	TBD	TBD	TBD
VIX(CK)	Differential Input Cross Point Voltage relative to VDD/2 for CK _t , CK _c	TBD	TBD	TBD	TBD

9.6 Single-ended AC & DC Output Levels

[Table 11] Single-ended AC & DC Output Levels

Symbol	Parameter	DDR4-1600/1866/2133/2400	Units	NOTE
V _{OH} (DC)	DC output high measurement level (for IV curve linearity)	1.1 x V _{DDQ}	V	
V _{OM} (DC)	DC output mid measurement level (for IV curve linearity)	0.8 x V _{DDQ}	V	
V _{OL} (DC)	DC output low measurement level (for IV curve linearity)	0.5 x V _{DDQ}	V	
V _{OH} (AC)	AC output high measurement level (for output SR)	(0.7 + 0.15) x V _{DDQ}	V	1
V _{OL} (AC)	AC output low measurement level (for output SR)	(0.7 - 0.15) x V _{DDQ}	V	1

NOTE :
 1. The swing of $\pm 0.15 \times V_{DDQ}$ is based on approximately 50% of the static single-ended output peak-to-peak swing with a driver impedance of RZQ/7Ω and an effective test load of 50Ω to V_{TT} = V_{DDQ}.

9.7 Differential AC & DC Output Levels

[Table 12] Differential AC & DC Output Levels

Symbol	Parameter	DDR4-1600/1866/2133/2400	Units	NOTE
V _{OHdiff} (AC)	AC differential output high measurement level (for output SR)	+0.3 x V _{DDQ}	V	1
V _{OLdiff} (AC)	AC differential output low measurement level (for output SR)	-0.3 x V _{DDQ}	V	1

NOTE :
 1. The swing of $\pm 0.3 \times V_{DDQ}$ is based on approximately 50% of the static differential output peak-to-peak swing with a driver impedance of RZQ/7Ω and an effective test load of 50Ω to V_{TT} = V_{DDQ} at each of the differential outputs.

9.8 Single-ended Output Slew Rate

With the reference load for timing measurements, output slew rate for falling and rising edges is defined and measured between V_{OL}(AC) and V_{OH}(AC) for single ended signals as shown in Table 13 and Figure 6.

[Table 13] Single-ended Output Slew Rate Definition

Description	Measured		Defined by
	From	To	
Single ended output slew rate for rising edge	V _{OL} (AC)	V _{OH} (AC)	[V _{OH} (AC)-V _{OL} (AC)] / Delta TRse
Single ended output slew rate for falling edge	V _{OH} (AC)	V _{OL} (AC)	[V _{OH} (AC)-V _{OL} (AC)] / Delta TFse

NOTE :
 1. Output slew rate is verified by design and characterization, and may not be subject to production test.

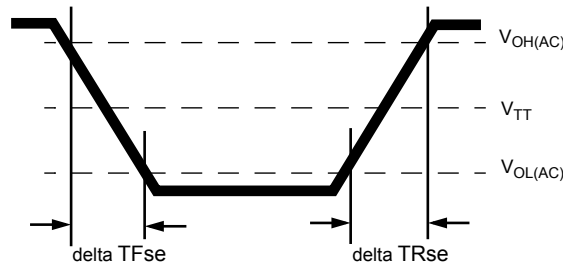

Figure 6. Single-ended Output Slew Rate Definition

[Table 14] Single-ended Output Slew Rate

Parameter	Symbol	DDR4-1600		DDR4-1866		DDR4-2133		DDR4-2400		Units
		Min	Max	Min	Max	Min	Max	Min	Max	
Single ended output slew rate	SRQse	4	9	4	9	4	9	4	9	V/ns

Description: SR: Slew Rate

Q: Query Output (like in DQ, which stands for Data-in, Query-Output)

se: Single-ended Signals

For Ron = RZQ/7 setting

NOTE :

1. In two cases, a maximum slew rate of 12 V/ns applies for a single DQ signal within a byte lane.

-Case 1 is defined for a single DQ signal within a byte lane which is switching into a certain direction (either from high to low or low to high) while all remaining DQ signals in the same byte lane are static (i.e. they stay at either high or low).

-Case 2 is defined for a single DQ signal within a byte lane which is switching into a certain direction (either from high to low or low to high) while all remaining DQ signals in the same byte lane are switching into the opposite direction (i.e. from low to high or high to low respectively). For the remaining DQ signal switching into the opposite direction, the regular maximum limit of 9 V/ns applies

9.9 Differential Output Slew Rate

With the reference load for timing measurements, output slew rate for falling and rising edges is defined and measured between VOLdiff(AC) and VOHdiff(AC) for differential signals as shown in Table 15 and Figure 7.

[Table 15] Differential Output Slew Rate Definition

Description	Measured		Defined by
	From	To	
Differential output slew rate for rising edge	V _{OLdiff(AC)}	V _{OHdiff(AC)}	$[V_{OHdiff(AC)} - V_{OLdiff(AC)}] / \Delta TR_{diff}$
Differential output slew rate for falling edge	V _{OHdiff(AC)}	V _{OLdiff(AC)}	$[V_{OHdiff(AC)} - V_{OLdiff(AC)}] / \Delta TF_{diff}$

NOTE :

1. Output slew rate is verified by design and characterization, and may not be subject to production test.

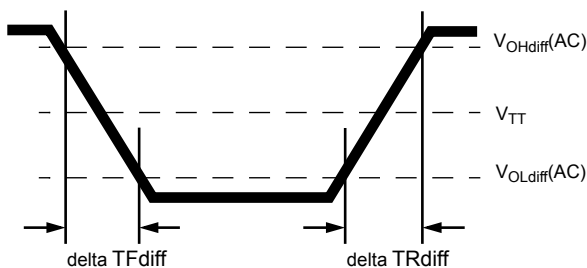

Figure 7. Differential Output Slew Rate Definition

[Table 16] Differential Output Slew Rate

Parameter	Symbol	DDR4-1600		DDR4-1866		DDR4-2133		DDR4-2400		Units
		Min	Max	Min	Max	Min	Max	Min	Max	
Differential output slew rate	SRQdiff	8	18	8	18	8	18	8	18	V/ns

Description:

SR: Slew Rate

Q: Query Output (like in DQ, which stands for Data-in, Query-Output)

diff: Differential Signals

For Ron = RZQ/7 setting

9.10 Single-ended AC & DC Output Levels of Connectivity Test Mode

Following output parameters will be applied for DDR4 SDRAM Output Signal during Connectivity Test Mode.

[Table 17] Single-ended AC & DC Output Levels of Connectivity Test Mode

Symbol	Parameter	DDR4-1600/1866/2133/2400	Unit	Notes
$V_{OH(DC)}$	DC output high measurement level (for IV curve linearity)	$1.1 \times V_{DDQ}$	V	
$V_{OM(DC)}$	DC output mid measurement level (for IV curve linearity)	$0.8 \times V_{DDQ}$	V	
$V_{OL(DC)}$	DC output low measurement level (for IV curve linearity)	$0.5 \times V_{DDQ}$	V	
$V_{OB(DC)}$	DC output below measurement level (for IV curve linearity)	$0.2 \times V_{DDQ}$	V	
$V_{OH(AC)}$	AC output high measurement level (for output SR)	$V_{TT} + (0.1 \times V_{DDQ})$	V	1
$V_{OL(AC)}$	AC output below measurement level (for output SR)	$V_{TT} - (0.1 \times V_{DDQ})$	V	1

NOTE :
 1. The effective test load is 50Ω terminated by $V_{TT} = 0.5 \times V_{DDQ}$.

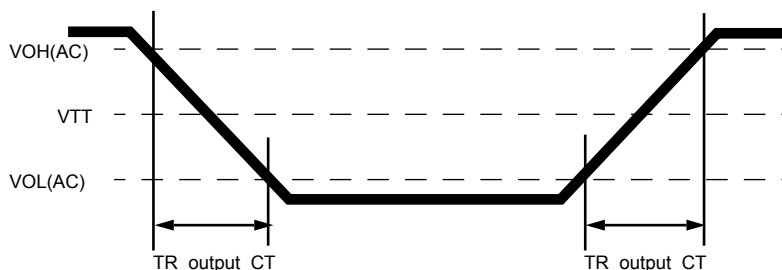

Figure 8. Output Slew Rate Definition of Connectivity Test Mode

[Table 18] Single-ended Output Slew Rate of Connectivity Test Mode

Parameter	Symbol	DDR4-1600/1866/2133/2400		Unit	Notes
		Min	Max		
Output signal Falling time	TF_output_CT	-	10	ns/V	
Output signal Rising time	TR_output_CT	-	10	ns/V	

9.11 Test Load for Connectivity Test Mode Timing

The reference load for ODT timings is defined in Figure 7.

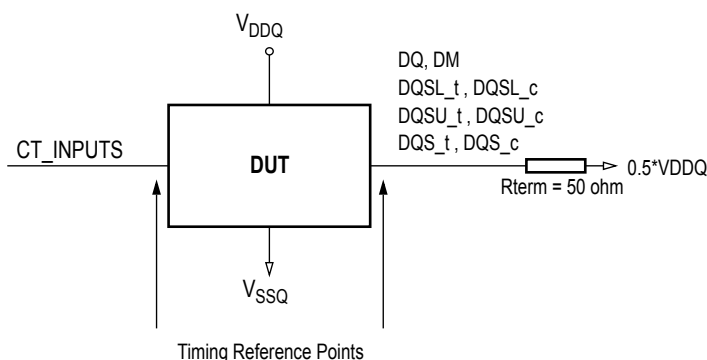

Figure 9. Connectivity Test Mode Timing Reference Load

10. DIMM IDD Specification Definition

[Table 19] Basic IDD, IPP and IDDQ Measurement Conditions

Symbol	Description
IDD0	Operating One Bank Active-Precharge Current (AL=0) CKE: High; External clock: On; tCK, nRC, nRAS, CL: Refer to Component Datasheet for detail pattern; BL: 8 ¹ ; AL: 0; CS_n: High between ACT and PRE; Command, Address, Bank Group Address, Bank Address Inputs: partially toggling; Data IO: VDDQ; DM_n: stable at 1; Bank Activity: Cycling with one bank active at a time: 0,0,1,1,2,2,... ; Output Buffer and RTT: Enabled in Mode Registers ² ; ODT Signal: stable at 0; Pattern Details: Refer to Component Datasheet for detail pattern
IDD0A	Operating One Bank Active-Precharge Current (AL=CL-1) AL = CL-1, Other conditions: see IDD0
IPP0	Operating One Bank Active-Precharge IPP Current Same condition with IDD0
IDD1	Operating One Bank Active-Read-Precharge Current (AL=0) CKE: High; External clock: On; tCK, nRC, nRAS, nRCD, CL: Refer to Component Datasheet for detail pattern; BL: 8 ¹ ; AL: 0; CS_n: High between ACT, RD and PRE; Command, Address, Bank Group Address, Bank Address Inputs, Data IO: partially toggling; DM_n: stable at 1; Bank Activity: Cycling with one bank active at a time: 0,0,1,1,2,2,... ; Output Buffer and RTT: Enabled in Mode Registers ² ; ODT Signal: stable at 0; Pattern Details: Refer to Component Datasheet for detail pattern
IDD1A	Operating One Bank Active-Read-Precharge Current (AL=CL-1) AL = CL-1, Other conditions: see IDD1
IPP1	Operating One Bank Active-Read-Precharge IPP Current Same condition with IDD1
IDD2N	Precharge Standby Current (AL=0) CKE: High; External clock: On; tCK, CL: Refer to Component Datasheet for detail pattern; BL: 8 ¹ ; AL: 0; CS_n: stable at 1; Command, Address, Bank Group Address, Bank Address Inputs: partially toggling ; Data IO: VDDQ; DM_n: stable at 1; Bank Activity: all banks closed; Output Buffer and RTT: Enabled in Mode Registers ² ; ODT Signal: stable at 0; Pattern Details: Refer to Component Datasheet for detail pattern
IDD2NA	Precharge Standby Current (AL=CL-1) AL = CL-1, Other conditions: see IDD2N
IPP2N	Precharge Standby IPP Current Same condition with IDD2N
IDD2NT	Precharge Standby ODT Current CKE: High; External clock: On; tCK, CL: Refer to Component Datasheet for detail pattern; BL: 8 ¹ ; AL: 0; CS_n: stable at 1; Command, Address, Bank Group Address, Bank Address Inputs: partially toggling ; Data IO: VSSQ; DM_n: stable at 1; Bank Activity: all banks closed; Output Buffer and RTT: Enabled in Mode Registers ² ; ODT Signal: toggling according ; Pattern Details: Refer to Component Datasheet for detail pattern
IDDQ2NT (Optional)	Precharge Standby ODT IDDQ Current Same definition like for IDD2NT, however measuring IDDQ current instead of IDD current
IDD2NL	Precharge Standby Current with CAL enabled Same definition like for IDD2N, CAL enabled ³
IDD2NG	Precharge Standby Current with Gear Down mode enabled Same definition like for IDD2N, Gear Down mode enabled ^{3,5}
IDD2ND	Precharge Standby Current with DLL disabled Same definition like for IDD2N, DLL disabled ³
IDD2N_par	Precharge Standby Current with CA parity enabled Same definition like for IDD2N, CA parity enabled ³
IDD2P	Precharge Power-Down Current CKE: Low; External clock: On; tCK, CL: Refer to Component Datasheet for detail pattern; BL: 8 ¹ ; AL: 0; CS_n: stable at 1; Command, Address, Bank Group Address, Bank Address Inputs: stable at 0; Data IO: VDDQ; DM_n: stable at 1; Bank Activity: all banks closed; Output Buffer and RTT: Enabled in Mode Registers ² ; ODT Signal: stable at 0
IPP2P	Precharge Power-Down IPP Current Same condition with IDD2P
IDD2Q	Precharge Quiet Standby Current CKE: High; External clock: On; tCK, CL: Refer to Component Datasheet for detail pattern; BL: 8 ¹ ; AL: 0; CS_n: stable at 1; Command, Address, Bank Group Address, Bank Address Inputs: stable at 0; Data IO: VDDQ; DM_n: stable at 1; Bank Activity: all banks closed; Output Buffer and RTT: Enabled in Mode Registers ² ; ODT Signal: stable at 0

Symbol	Description
IDD3N	Active Standby Current CKE: High; External clock: On; tCK, CL: Refer to Component Datasheet for detail pattern; BL: 8 ¹ ; AL: 0; CS_n: stable at 1; Command, Address, Bank Group Address, Bank Address Inputs: partially toggling; Data IO: VDDQ; DM_n: stable at 1; Bank Activity: all banks open; Output Buffer and RTT: Enabled in Mode Registers ² ; ODT Signal: stable at 0; Pattern Details: Refer to Component Datasheet for detail pattern
IDD3NA	Active Standby Current (AL=CL-1) AL = CL-1, Other conditions: see IDD3N
IPP3N	Active Standby IPP Current Same condition with IDD3N
IDD3P	Active Power-Down Current CKE: Low; External clock: On; tCK, CL: Refer to Component Datasheet for detail pattern; BL: 8 ¹ ; AL: 0; CS_n: stable at 1; Command, Address, Bank Group Address, Bank Address Inputs: stable at 0; Data IO: VDDQ; DM_n: stable at 1; Bank Activity: all banks open; Output Buffer and RTT: Enabled in Mode Registers ² ; ODT Signal: stable at 0
IPP3P	Active Power-Down IPP Current Same condition with IDD3P
IDD4R	Operating Burst Read Current CKE: High; External clock: On; tCK, CL: Refer to Component Datasheet for detail pattern; BL: 8 ² ; AL: 0; CS_n: High between RD; Command, Address, Bank Group Address, Bank Address Inputs: partially toggling; Data IO: seamless read data burst with different data between one burst and the next one according; DM_n: stable at 1; Bank Activity: all banks open, RD commands cycling through banks: 0,0,1,1,2,2,...; Output Buffer and RTT: Enabled in Mode Registers ² ; ODT Signal: stable at 0; Pattern Details: Refer to Component Datasheet for detail pattern
IDD4RA	Operating Burst Read Current (AL=CL-1) AL = CL-1, Other conditions: see IDD4R
IDD4RB	Operating Burst Read Current with Read DBI Read DBI enabled ³ , Other conditions: see IDD4R
IPP4R	Operating Burst Read IPP Current Same condition with IDD4R
IDDQ4R (Optional)	Operating Burst Read IDDQ Current Same definition like for IDD4R, however measuring IDDQ current instead of IDD current
IDDQ4RB (Optional)	Operating Burst Read IDDQ Current with Read DBI Same definition like for IDD4RB, however measuring IDDQ current instead of IDD current
IDD4W	Operating Burst Write Current CKE: High; External clock: On; tCK, CL: Refer to Component Datasheet for detail pattern; BL: 8 ¹ ; AL: 0; CS_n: High between WR; Command, Address, Bank Group Address, Bank Address Inputs: partially toggling; Data IO: seamless write data burst with different data between one burst and the next one; DM_n: stable at 1; Bank Activity: all banks open, WR commands cycling through banks: 0,0,1,1,2,2,...; Output Buffer and RTT: Enabled in Mode Registers ² ; ODT Signal: stable at HIGH; Pattern Details: Refer to Component Datasheet for detail pattern
IDD4WA	Operating Burst Write Current (AL=CL-1) AL = CL-1, Other conditions: see IDD4W
IDD4WB	Operating Burst Write Current with Write DBI Write DBI enabled ³ , Other conditions: see IDD4W
IDD4WC	Operating Burst Write Current with Write CRC Write CRC enabled ³ , Other conditions: see IDD4W
IDD4W_par	Operating Burst Write Current with CA Parity CA Parity enabled ³ , Other conditions: see IDD4W
IPP4W	Operating Burst Write IPP Current Same condition with IDD4W
IDD5B	Burst Refresh Current (1X REF) CKE: High; External clock: On; tCK, CL, nRFC: Refer to Component Datasheet for detail pattern; BL: 8 ¹ ; AL: 0; CS_n: High between REF; Command, Address, Bank Group Address, Bank Address Inputs: partially toggling; Data IO: VDDQ; DM_n: stable at 1; Bank Activity: REF command every nRFC; Output Buffer and RTT: Enabled in Mode Registers ² ; ODT Signal: stable at 0; Pattern Details: Refer to Component Datasheet for detail pattern
IPP5B	Burst Refresh Write IPP Current (1X REF) Same condition with IDD5B
IDD5F2	Burst Refresh Current (2X REF) tRFC=tRFC_x2, Other conditions: see IDD5B
IPP5F2	Burst Refresh Write IPP Current (2X REF) Same condition with IDD5F2

Symbol	Description
IDD5F4	Burst Refresh Current (4X REF) tRFC=tRFC_x4, Other conditions: see IDD5B
IPP5F4	Burst Refresh Write IPP Current (4X REF) Same condition with IDD5F4
IDD6N	Self Refresh Current: Normal Temperature Range T _{CASE} : 0 - 85°C; Low Power Array Self Refresh (LP ASR) : Normal ⁴ ; CKE : Low; External clock : Off; CK_t and CK_c#: LOW; CL : Refer to Component Datasheet for detail pattern; BL : 8 ¹ ; AL : 0; CS_n#, Command, Address, Bank Group Address, Bank Address, Data IO : High; DM_n : stable at 1; Bank Activity : Self-Refresh operation; Output Buffer and RTT : Enabled in Mode Registers ² ; ODT Signal : MID-LEVEL
IPP6N	Self Refresh IPP Current: Normal Temperature Range Same condition with IDD6N
IDD6E	Self-Refresh Current: Extended Temperature Range ¹⁾ T _{CASE} : 0 - 95°C; Low Power Array Self Refresh (LP ASR) : Extended ⁴ ; CKE : Low; External clock : Off; CK_t and CK_c#: LOW; CL : Refer to Component Datasheet for detail pattern; BL : 8 ¹ ; AL : 0; CS_n#, Command, Address, Bank Group Address, Bank Address, Data IO : High; DM_n :stable at 1; Bank Activity : Extended Temperature Self-Refresh operation; Output Buffer and RTT : Enabled in Mode Registers ² ; ODT Signal : MID-LEVEL
IPP6E	Self Refresh IPP Current: Extended Temperature Range Same condition with IDD6E
IDD6R	Self-Refresh Current: Reduced Temperature Range T _{CASE} : 0 - 45°C; Low Power Array Self Refresh (LP ASR) : Reduced ⁴ ; CKE : Low; External clock : Off; CK_t and CK_c#: LOW; CL : Refer to Component Datasheet for detail pattern; BL : 8 ¹ ; AL : 0; CS_n#, Command, Address, Bank Group Address, Bank Address, Data IO : High; DM_n :stable at 1; Bank Activity : Extended Temperature Self-Refresh operation; Output Buffer and RTT : Enabled in Mode Registers ² ; ODT Signal : MID-LEVEL
IPP6R	Self Refresh IPP Current: Reduced Temperature Range Same condition with IDD6R
IDD6A	Auto Self-Refresh Current T _{CASE} : 0 - 95°C; Low Power Array Self Refresh (LP ASR) : Auto ⁴ ; CKE : Low; External clock : Off; CK_t and CK_c#: LOW; CL : Refer to Component Datasheet for detail pattern; BL : 8 ¹ ; AL : 0; CS_n#, Command, Address, Bank Group Address, Bank Address, Data IO : High; DM_n :stable at 1; Bank Activity : Auto Self-Refresh operation; Output Buffer and RTT : Enabled in Mode Registers ² ; ODT Signal : MID-LEVEL
IPP6A	Auto Self-Refresh IPP Current Same condition with IDD6A
IDD7	Operating Bank Interleave Read Current CKE : High; External clock : On; tCK, nRC, nRAS, nRCD, nRRD, nFAW, CL : Refer to Component Datasheet for detail pattern; BL : 8 ¹ ; AL : CL-1; CS_n : High between ACT and RDA; Command, Address, Bank Group Address, Bank Address Inputs : partially toggling ; Data IO : read data bursts with different data between one burst and the next one ; DM_n : stable at 1; Bank Activity : two times interleaved cycling through banks (0, 1, ...7) with different addressing; Output Buffer and RTT : Enabled in Mode Registers ² ; ODT Signal : stable at 0; Pattern Details : Refer to Component Datasheet for detail pattern
IPP7	Operating Bank Interleave Read IPP Current Same condition with IDD7
IDD8	Maximum Power Down Current TBD
IPP8	Maximum Power Down IPP Current Same condition with IDD8

NOTE :

- Burst Length: BL8 fixed by MRS: set MR0 [A1:0=00].
- Output Buffer Enable
 - set MR1 [A12 = 0] : Qoff = Output buffer enabled
 - set MR1 [A2:1 = 00] : Output Driver Impedance Control = RZQ/7
 - RTT_Nom enable
 - set MR1 [A10:8 = 011] : RTT_NOM = RZQ/6
 - RTT_WR enable
 - set MR2 [A10:9 = 01] : RTT_WR = RZQ/2
 - RTT_PARK disable
 - set MR5 [A8:6 = 000]
- CAL enabled : set MR4 [A8:6 = 001] : 1600MT/s
010] : 1866MT/s, 2133MT/s
011] : 2400MT/s
Gear Down mode enabled :set MR3 [A3 = 1] : 1/4 Rate
DLL disabled : set MR1 [A0 = 0]
CA parity enabled :set MR5 [A2:0 = 001] : 1600MT/s,1866MT/s, 2133MT/s
010] : 2400MT/s
Read DBI enabled : set MR5 [A12 = 1]
Write DBI enabled : set :MR5 [A11 = 1]
- Low Power Array Self Refresh (LP ASR) : set MR2 [A7:6 = 00] : Normal
01] : Reduced Temperature range
10] : Extended Temperature range
11] : Auto Self Refresh
- IDD2NG should be measured after sync pules(NOP) input.

11. IDD SPEC Table

IDD and IPP values are for full operating range of voltage and temperature unless otherwise noted. IDD and IPP values are for full operating range of voltage and temperature unless otherwise noted.

[Table 20] I_{DD} and I_{DDQ} Specification

Symbol	M378A1K43BB1 : 8GB(1Gx64) Module		M378A1K43BB2 : 8GB(1Gx64) Module		Unit	NOTE
	DDR4-2133		DDR4-2400			
	15-15-15		17-17-17			
	VDD 1.2V	VPP 2.5V	VDD 1.2V	VPP 2.5V		
	IDD Max.	IPP Max.	IDD Max.	IPP Max.		
I_{DD0}	248	32	248	32	mA	
I_{DD0A}	256	32	272	32	mA	
I_{DD1}	352	32	360	32	mA	
I_{DD1A}	376	32	384	32	mA	
I_{DD2N}	176	24	184	24	mA	
I_{DD2NA}	200	24	208	24	mA	
I_{DD2NT}	200	24	208	24	mA	
I_{DD2NL}	120	24	136	24	mA	
I_{DD2NG}	176	24	184	24	mA	
I_{DD2ND}	160	24	168	24	mA	
I_{DD2N_par}	184	24	192	24	mA	
I_{DD2P}	128	24	128	24	mA	
I_{DD2Q}	160	24	168	24	mA	
I_{DD3N}	288	24	288	24	mA	
I_{DD3NA}	304	24	304	24	mA	
I_{DD3P}	168	24	176	24	mA	
I_{DD4R}	808	24	856	24	mA	
I_{DD4RA}	840	24	888	24	mA	
I_{DD4RB}	816	24	872	24	mA	
I_{DD4W}	672	24	712	24	mA	
I_{DD4WA}	704	24	752	24	mA	
I_{DD4WB}	672	24	720	24	mA	
I_{DD4WC}	592	24	664	24	mA	
I_{DD4W_par}	736	24	792	24	mA	
I_{DD5B}	1592	144	1592	144	mA	
I_{DD5F2}	1104	120	1112	120	mA	
I_{DD5F4}	928	112	936	112	mA	
I_{DD6N}	184	32	184	32	mA	
I_{DD6E}	272	40	272	40	mA	
I_{DD6R}	128	28	128	28	mA	
I_{DD6A}	176	32	176	32	mA	
I_{DD7}	1136	64	1144	68	mA	
I_{DD8}	88	24	88	24	mA	

NOTE :

- DIMM IDD SPEC is based on the condition that de-activated rank(IDLE) is IDD2N. Please refer to Table 21.
- IDD current measure method and detail patterns are described on DDR4 component datasheet.
- VDD and VDDQ are merged on module PCB (IDDQ values are not considered by Qoff condition)
- DIMM IDD Values are calculated based on the component IDD spec and Register power.

Symbol	M378A2K43BB1 : 16GB(2Gx64) Module				Unit	NOTE
	DDR4-2133		DDR4-2400			
	15-15-15		17-17-17			
	VDD 1.2V	VPP 2.5V	VDD 1.2V	VPP 2.5V		
	IDD Max.	IPP Max.	IDD Max.	IPP Max.		
I_{DD0}	424	56	432	56	mA	
I_{DD0A}	432	56	456	56	mA	
I_{DD1}	528	56	544	56	mA	
I_{DD1A}	552	56	568	56	mA	
I_{DD2N}	352	48	368	48	mA	
I_{DD2NA}	400	48	416	48	mA	
I_{DD2NT}	400	48	416	48	mA	
I_{DD2NL}	240	48	272	48	mA	
I_{DD2NG}	352	48	368	48	mA	
I_{DD2ND}	320	48	336	48	mA	
I_{DD2N_par}	368	48	384	48	mA	
I_{DD2P}	256	48	256	48	mA	
I_{DD2Q}	320	48	336	48	mA	
I_{DD3N}	576	48	576	48	mA	
I_{DD3NA}	608	48	608	48	mA	
I_{DD3P}	336	48	352	48	mA	
I_{DD4R}	984	48	1040	48	mA	
I_{DD4RA}	1016	48	1072	48	mA	
I_{DD4RB}	992	48	1056	48	mA	
I_{DD4W}	848	48	896	48	mA	
I_{DD4WA}	880	48	936	48	mA	
I_{DD4WB}	848	48	904	48	mA	
I_{DD4WC}	768	48	848	48	mA	
I_{DD4W_par}	912	48	976	48	mA	
I_{DD5B}	1768	168	1776	168	mA	
I_{DD5F2}	1280	144	1296	144	mA	
I_{DD5F4}	1104	136	1120	136	mA	
I_{DD6N}	368	64	368	64	mA	
I_{DD6E}	544	80	544	80	mA	
I_{DD6R}	256	56	256	56	mA	
I_{DD6A}	352	64	352	64	mA	
I_{DD7}	1312	88	1328	92	mA	
I_{DD8}	176	48	176	48	mA	

NOTE :

1. DIMM IDD SPEC is based on the condition that de-activated rank(IDLE) is IDD2N. Please refer to Table 21.
2. IDD current measure method and detail patterns are described on DDR4 component datasheet.
3. VDD and VDDQ are merged on module PCB (IDDQ values are not considered by Qoff condition)
4. DIMM IDD Values are calculated based on the component IDD spec and Register power.

Symbol	M391A2K43BB1 : 16GB(2Gx72) Module				Unit	NOTE
	DDR4-2133		DDR4-2400			
	15-15-15		17-17-17			
	VDD 1.2V	VPP 2.5V	VDD 1.2V	VPP 2.5V		
	IDD Max.	IPP Max.	IDD Max.	IPP Max.		
I_{DD0}	477	63	486	63	mA	
I_{DD0A}	486	63	513	63	mA	
I_{DD1}	594	63	612	63	mA	
I_{DD1A}	621	63	639	63	mA	
I_{DD2N}	396	54	414	54	mA	
I_{DD2NA}	450	54	468	54	mA	
I_{DD2NT}	450	54	468	54	mA	
I_{DD2NL}	270	54	306	54	mA	
I_{DD2NG}	396	54	414	54	mA	
I_{DD2ND}	360	54	378	54	mA	
I_{DD2N_par}	414	54	432	54	mA	
I_{DD2P}	288	54	288	54	mA	
I_{DD2Q}	360	54	378	54	mA	
I_{DD3N}	648	54	648	54	mA	
I_{DD3NA}	684	54	684	54	mA	
I_{DD3P}	378	54	396	54	mA	
I_{DD4R}	1107	54	1170	54	mA	
I_{DD4RA}	1143	54	1206	54	mA	
I_{DD4RB}	1116	54	1188	54	mA	
I_{DD4W}	954	54	1008	54	mA	
I_{DD4WA}	990	54	1053	54	mA	
I_{DD4WB}	954	54	1017	54	mA	
I_{DD4WC}	864	54	954	54	mA	
I_{DD4W_par}	1026	54	1098	54	mA	
I_{DD5B}	1989	189	1998	189	mA	
I_{DD5F2}	1440	162	1458	162	mA	
I_{DD5F4}	1242	153	1260	153	mA	
I_{DD6N}	414	72	414	72	mA	
I_{DD6E}	612	90	612	90	mA	
I_{DD6R}	288	63	288	63	mA	
I_{DD6A}	396	72	396	72	mA	
I_{DD7}	1476	99	1494	104	mA	
I_{DD8}	198	54	198	54	mA	

NOTE :

- DIMM IDD SPEC is based on the condition that de-activated rank(IDLE) is IDD2N. Please refer to Table 21.
- IDD current measure method and detail patterns are described on DDR4 component datasheet.
- VDD and VDDQ are merged on module PCB (IDDQ values are not considered by Goff condition)
- DIMM IDD Values are calculated based on the component IDD spec and Register power.

[Table 21] DIMM Rank Status

SEC DIMM	Operating Rank	The other Rank
<i>I</i> _{DD0}	<i>I</i> _{DD0}	<i>I</i> _{DD2N}
<i>I</i> _{DD1}	<i>I</i> _{DD1}	<i>I</i> _{DD2N}
<i>I</i> _{DD2P}	<i>I</i> _{DD2P}	<i>I</i> _{DD2P}
<i>I</i> _{DD2N}	<i>I</i> _{DD2N}	<i>I</i> _{DD2N}
<i>I</i> _{DD2Q}	<i>I</i> _{DD2Q}	<i>I</i> _{DD2Q}
<i>I</i> _{DD3P}	<i>I</i> _{DD3P}	<i>I</i> _{DD3P}
<i>I</i> _{DD3N}	<i>I</i> _{DD3N}	<i>I</i> _{DD3N}
<i>I</i> _{DD4R}	<i>I</i> _{DD4R}	<i>I</i> _{DD2N}
<i>I</i> _{DD4W}	<i>I</i> _{DD4W}	<i>I</i> _{DD2N}
<i>I</i> _{DD5B}	<i>I</i> _{DD5B}	<i>I</i> _{DD2N}
<i>I</i> _{DD6}	<i>I</i> _{DD6}	<i>I</i> _{DD6}
<i>I</i> _{DD7}	<i>I</i> _{DD7}	<i>I</i> _{DD2N}
<i>I</i> _{DD8}	<i>I</i> _{DD8}	<i>I</i> _{DD8}

12. Input/Output Capacitance

[Table 22] Silicon Pad I/O Capacitance

Symbol	Parameter	DDR4-1600/1866/2133		DDR4-2400		Unit	NOTE
		min	max	min	max		
C _{IO}	Input/output capacitance	0.55	1.4	0.55	1.15	pF	1,2,3
C _{DIO}	Input/output capacitance delta	-0.1	0.1	-0.1	0.1	pF	1,2,3,11
C _{DDQS}	Input/output capacitance delta DQS _t and DQS _c	-	0.05	-	0.05	pF	1,2,3,5
C _{CK}	Input capacitance, CK _t and CK _c	0.2	0.8	0.2	0.7	pF	1,3
C _{DCK}	Input capacitance delta CK _t and CK _c	-	0.05	-	0.05	pF	1,3,4
C _I	Input capacitance(CTRL, ADD, CMD pins only)	0.2	0.8	0.2	0.7	pF	1,3,6
C _{DI_CTRL}	Input capacitance delta(All CTRL pins only)	-0.1	0.1	-0.1	0.1	pF	1,3,7,8
C _{DI_ADD_CMD}	Input capacitance delta(All ADD/CMD pins only)	-0.1	0.1	-0.1	0.1	pF	1,2,9,10
C _{ALERT}	Input/output capacitance of ALERT	0.5	1.5	0.5	1.5	pF	1,3
C _{ZQ}	Input/output capacitance of ZQ	0.5	2.3	0.5	2.3	pF	1,3,12
C _{TEN}	Input capacitance of TEN	0.2	2.3	0.2	2.3	pF	1,3,13

NOTE:

1. This parameter is not subject to production test. It is verified by design and characterization. The silicon only capacitance is validated by de-embedding the package L & C parasitic. The capacitance is measured with VDD, VDDQ, VSS, VSSQ applied with all other signal pins floating. Measurement procedure tbd.
2. DQ, DM_n, DQS_T, DQS_c, TDQS_T, TDQS_C. Although the DM, TDQS_T and TDQS_C pins have different functions, the loading matches DQ and DQS
3. This parameter applies to monolithic devices only; stacked/dual-die devices are not covered here
4. Absolute value CK_T-CK_C
5. Absolute value of CIO(DQS_T)-CIO(DQS_c)
6. C_I applies to ODT, CS_n, CKE, A0-A17, BA0-BA1, BG0-BG1, RAS_n/A16, CAS_n/A15, WE_n/A14, ACT_n and PAR.
7. C_{DI_CTRL} applies to ODT, CS_n and CKE
8. $C_{DI_CTRL} = C_I(CTRL) - 0.5 * (C_I(CLK_T) + C_I(CLK_C))$
9. C_{DI_ADD_CMD} applies to, A0-A17, BA0-BA1, BG0-BG1, RAS_n/A16, CAS_n/A15, WE_n/A14, ACT_n and PAR.
10. $C_{DI_ADD_CMD} = C_I(ADD_CMD) - 0.5 * (C_I(CLK_T) + C_I(CLK_C))$
11. $C_{DIO} = C_{IO}(DQ, DM) - 0.5 * (C_{IO}(DQS_T) + C_{IO}(DQS_c))$
12. Maximum external load capacitance on ZQ pin: tbd pF.
13. TEN pin may be DRAM internally pulled low through a weak pull-down resistor to VSS. In this case C_{TEN} might not be valid and system shall verify TEN signal with Vendor specific information.

13. Electrical Characteristics and AC Timing

13.1 Speed Bins and CL, tRCD, tRP, tRC and tRAS for Corresponding Bin

[Table 23] DDR4-1600 Speed Bins and Operations

Speed Bin			DDR4-1600		Unit	NOTE	
CL-nRCD-nRP			11-11-11				
Parameter	Symbol		min	max			
Internal read command to first data	tAA		13.75	18.00	ns	10	
Internal read command to first data with read DBI enabled	tAA_DBI		tAA(min) + 2nCK	tAA(max) + 2nCK	ns	10	
ACT to internal read or write delay time	tRCD		13.75	-	ns	10	
PRE command period	tRP		13.75	-	ns	10	
ACT to PRE command period	tRAS		35	9 x tREFI	ns	10	
ACT to ACT or REF command period	tRC		48.75	-	ns	10	
	Normal	Read DBI					
CWL = 9	CL = 9	CL = 11	tCK(AVG)	Reserved		ns	1,2,3,4,9
	CL = 10	CL = 12	tCK(AVG)	1.5	1.6	ns	1,2,3,4,9
CWL = 9,11	CL = 10	CL = 12	tCK(AVG)	Reserved		ns	1,2,3,4
	CL = 11	CL = 13	tCK(AVG)	1.25	<1.5	ns	1,2,3,4
	CL = 12	CL = 14	tCK(AVG)	1.25	<1.5	ns	1,2,3
Supported CL Settings			10,11,12		nCK		
Supported CL Settings with read DBI			12,13,14		nCK		
Supported CWL Settings			9,11		nCK		

[Table 24] DDR4-1866 Speed Bins and Operations

Speed Bin			DDR4-1866		Unit	NOTE	
CL-nRCD-nRP			13-13-13				
Parameter	Symbol		min	max			
Internal read command to first data	tAA		13.92	18.00	ns	10	
Internal read command to first data with read DBI enabled	tAA_DBI		tAA(min) + 2nCK	tAA(max) + 2nCK	ns	10	
ACT to internal read or write delay time	tRCD		13.92	-	ns	10	
PRE command period	tRP		13.92	-	ns	10	
ACT to PRE command period	tRAS		34	9 x tREFI	ns	10	
ACT to ACT or REF command period	tRC		47.92	-	ns	10	
	Normal	Read DBI					
CWL = 9	CL = 9	CL = 11	tCK(AVG)	Reserved		ns	1,2,3,4,9
	CL = 10	CL = 12	tCK(AVG)	1.5	1.6	ns	1,2,3,4,9
CWL = 9,11	CL = 10	CL = 12	tCK(AVG)	Reserved		ns	4
	CL = 11	CL = 13	tCK(AVG)	1.25	<1.5	ns	1,2,3,4,6
	CL = 12	CL = 14	tCK(AVG)	1.25	<1.5	ns	1,2,3,6
CWL = 10,12	CL = 12	CL = 14	tCK(AVG)	Reserved		ns	1,2,3,4
	CL = 13	CL = 15	tCK(AVG)	1.071	<1.25	ns	1,2,3,4
	CL = 14	CL = 16	tCK(AVG)	1.071	<1.25	ns	1,2,3
Supported CL Settings			10,11,12,13,14		nCK		
Supported CL Settings with read DBI			12,13,14,15,16		nCK		
Supported CWL Settings			9,10,11,12		nCK		

[Table 25] DDR4-2133 Speed Bins and Operations

Speed Bin			DDR4-2133		Unit	NOTE	
CL-nRCD-nRP			15-15-15				
Parameter	Symbol		min	max			
Internal read command to first data	tAA		14.06 (13.75) ⁵	18.00	ns	10	
Internal read command to first data with read DBI enabled	tAA_DBI		tAA(min) + 3nCK	tAA(max) + 3nCK	ns	10	
ACT to internal read or write delay time	tRCD		14.06 (13.75) ⁵	-	ns	10	
PRE command period	tRP		14.06 (13.75) ⁵	-	ns	10	
ACT to PRE command period	tRAS		33	9 x tREFI	ns	10	
ACT to ACT or REF command period	tRC		47.06 (46.75) ⁵	-	ns	10	
	Normal	Read DBI					
CWL = 9	CL = 9	CL = 11	tCK(AVG)	Reserved		ns	1,2,3,4,9
	CL = 10	CL = 12	tCK(AVG)	1.5	1.6	ns	1,2,3,4,9
CWL = 9,11	CL = 11	CL = 13	tCK(AVG)	1.25	<1.5	ns	1,2,3,4,7
	CL = 12	CL = 14	tCK(AVG)	1.25	<1.5	ns	1,2,3,7
CWL = 10,12	CL = 13	CL = 15	tCK(AVG)	1.071	<1.25	ns	1,2,3,4,7
	CL = 14	CL = 16	tCK(AVG)	1.071	<1.25	ns	1,2,3,7
CWL = 11,14	CL = 14	CL = 17	tCK(AVG)	Reserved		ns	1,2,3,4
	CL = 15	CL = 18	tCK(AVG)	0.938	<1.071	ns	1,2,3,4
	CL = 16	CL = 19	tCK(AVG)	0.938	<1.071	ns	1,2,3
Supported CL Settings			10,11,12,13,14,15,16		nCK		
Supported CL Settings with read DBI			12,13,14,15,16,18,19		nCK		
Supported CWL Settings			9,10,11,12,14		nCK		

[Table 26] DDR4-2400 Speed Bins and Operations

Speed Bin			DDR4-2400		Unit	NOTE	
CL-nRCD-nRP			17-17-17				
Parameter	Symbol	min	max				
Internal read command to first data	tAA	14.16 (13.75) ⁵	18.00	ns	10		
Internal read command to first data with read DBI enabled	tAA_DBI	tAA(min) + 3nCK	tAA(max) + 3nCK	ns	10		
ACT to internal read or write delay time	tRCD	14.16 (13.75) ⁵	-	ns	10		
PRE command period	tRP	14.16 (13.75) ⁵	-	ns	10		
ACT to PRE command period	tRAS	32	9 x tREFI	ns	10		
ACT to ACT or REF command period	tRC	46.16 (45.75) ⁵	-	ns	10		
	Normal	Read DBI					
CWL = 9	CL = 9	CL = 11	tCK(AVG)	Reserved	ns	1,2,3,4,9	
	CL = 10	CL = 12	tCK(AVG)	1.5	1.6	ns	1,2,3,4,9
CWL = 9,11	CL = 10	CL = 12	tCK(AVG)	Reserved	ns	4	
	CL = 11	CL = 13	tCK(AVG)	1.25	<1.5	ns	1,2,3,4,8
	CL = 12	CL = 14	tCK(AVG)	1.25	<1.5	ns	1,2,3,8
CWL = 10,12	CL = 12	CL = 14	tCK(AVG)	Reserved	ns	4	
	CL = 13	CL = 15	tCK(AVG)	1.071	<1.25	ns	1,2,3,4,8
	CL = 14	CL = 16	tCK(AVG)	1.071	<1.25	ns	1,2,3,8
CWL = 11,14	CL = 14	CL = 17	tCK(AVG)	Reserved	ns	4	
	CL = 15	CL = 18	tCK(AVG)	0.938	<1.071	ns	1,2,3,4,8
	CL = 16	CL = 19	tCK(AVG)	0.938	<1.071	ns	1,2,3,8
CWL = 12,16	CL = 15	CL = 18	tCK(AVG)	Reserved	ns	1,2,3,4	
	CL = 16	CL = 19	tCK(AVG)	Reserved	ns	1,2,3,4	
	CL = 17	CL = 20	tCK(AVG)	0.833	<0.938		
	CL = 18	CL = 21	tCK(AVG)	0.833	<0.938	ns	1,2,3
Supported CL Settings			10,11,12,13,14,15,16,17,18		nCK		
Supported CL Settings with read DBI			12,13,14,15,16,18,19,20,21		nCK		
Supported CWL Settings			9,10,11,12,14,16		nCK		

13.2 Speed Bin Table Note

Absolute Specification

- VDDQ = VDD = 1.20V +/- 0.06 V
- VPP = 2.5V +0.25/-0.125 V
- The values defined with above-mentioned table are DLL ON case.
- DDR4-1600, 1866, 2133 and 2400 Speed Bin Tables are valid only when Geardown Mode is disabled.

1. The CL setting and CWL setting result in tCK(avg).MIN and tCK(avg).MAX requirements. When making a selection of tCK(avg), both need to be fulfilled: Requirements from CL setting as well as requirements from CWL setting.
2. tCK(avg).MIN limits: Since CAS Latency is not purely analog - data and strobe output are synchronized by the DLL - all possible intermediate frequencies may not be guaranteed. An application should use the next smaller JEDEC standard tCK(avg) value (1.5, 1.25, 1.071, 0.938 or 0.833 ns) when calculating CL [nCK] = tAA [ns] / tCK(avg) [ns], rounding up to the next 'Supported CL', where tAA = 12.5ns and tCK(avg) = 1.3 ns should only be used for CL = 10 calculation.
3. tCK(avg).MAX limits: Calculate tCK(avg) = tAA.MAX / CL SELECTED and round the resulting tCK(avg) down to the next valid speed bin (i.e. 1.5ns or 1.25ns or 1.071 ns or 0.938 ns or 0.833 ns). This result is tCK(avg).MAX corresponding to CL SELECTED.
4. 'Reserved' settings are not allowed. User must program a different value.
5. 'Optional' settings allow certain devices in the industry to support this setting, however, it is not a mandatory feature. Refer to supplier's data sheet and/or the DIMM SPD information if and how this setting is supported.
6. Any DDR4-1866 speed bin also supports functional operation at lower frequencies as shown in the table which are not subject to Production Tests but verified by Design/Characterization.
7. Any DDR4-2133 speed bin also supports functional operation at lower frequencies as shown in the table which are not subject to Production Tests but verified by Design/Characterization.
8. Any DDR4-2400 speed bin also supports functional operation at lower frequencies as shown in the table which are not subject to Production Tests but verified by Design/Characterization.
9. DDR4-1600 AC timing apply if DRAM operates at lower than 1600 MT/s data rate.
10. Parameters apply from tCK(avg)min to tCK(avg)max at all standard JEDEC clock period values as stated in the Speed Bin Tables.

14. Timing Parameters by Speed Grade

[Table 27] Timing Parameters by Speed Bin for DDR4-1600 to DDR4-2400

Speed		DDR4-1600		DDR4-1866		DDR4-2133		DDR4-2400		Units	NOTE	
Parameter	Symbol	MIN	MAX	MIN	MAX	MIN	MAX	MIN	MAX			
Clock Timing												
Minimum Clock Cycle Time (DLL off mode)	tCK (DLL_OFF)	8	20	8	20	8	20	8	20	ns		
Average Clock Period	tCK(avg)	1.25	<1.5	1.071	<1.25	0.938	<1.071	0.833	<0.938	ns	35,36	
Average high pulse width	tCH(avg)	0.48	0.52	0.48	0.52	0.48	0.52	0.48	0.52	tCK(avg)		
Average low pulse width	tCL(avg)	0.48	0.52	0.48	0.52	0.48	0.52	0.48	0.52	tCK(avg)		
Absolute Clock Period	tCK(abs)	tCK(avg)min + tJIT(per)min_to t	tCK(avg)max + tJIT(per)max_tot	tCK(avg)min + tJIT(per)min_to t	tCK(avg)max + tJIT(per)max_tot	tCK(avg)min + tJIT(per)min_to t	tCK(avg)max + tJIT(per)max_tot	tCK(avg)min + tJIT(per)min_to t	tCK(avg)max + tJIT(per)max_tot	tCK(avg)		
Absolute clock HIGH pulse width	tCH(abs)	0.45	-	0.45	-	0.45	-	0.45	-	tCK(avg)	23	
Absolute clock LOW pulse width	tCL(abs)	0.45	-	0.45	-	0.45	-	0.45	-	tCK(avg)	24	
Clock Period Jitter- total	JIT(per)_tot	-63	63	-54	54	-47	47	-42	42	ps	23	
Clock Period Jitter- deterministic	JIT(per)_dj	-31	31	-27	27	-23	23	-21	21	ps	26	
Clock Period Jitter during DLL locking period	tJIT(per, lck)	-50	50	-43	43	-38	38	-33	33	ps		
Cycle to Cycle Period Jitter	tJIT(cc)_total	125		107		94		83		ps	25	
Cycle to Cycle Period Jitter deterministic	tJIT(cc)_dj	63		54		47		42		ps	26	
Cycle to Cycle Period Jitter during DLL locking period	tJIT(cc, lck)	100		86		75		67		ps		
Duty Cycle Jitter	tJIT(duty)	TBD	TBD	TBD	TBD	TBD	TBD	TBD	TBD	ps		
Cumulative error across 2 cycles	tERR(2per)	-92	92	-79	79	-69	69	-61	61	ps		
Cumulative error across 3 cycles	tERR(3per)	-109	109	-94	94	-82	82	-73	73	ps		
Cumulative error across 4 cycles	tERR(4per)	-121	121	-104	104	-91	91	-81	81	ps		
Cumulative error across 5 cycles	tERR(5per)	-131	131	-112	112	-98	98	-87	87	ps		
Cumulative error across 6 cycles	tERR(6per)	-139	139	-119	119	-104	104	-92	92	ps		
Cumulative error across 7 cycles	tERR(7per)	-145	145	-124	124	-109	109	-97	97	ps		
Cumulative error across 8 cycles	tERR(8per)	-151	151	-129	129	-113	113	-101	101	ps		
Cumulative error across 9 cycles	tERR(9per)	-156	156	-134	134	-117	117	-104	104	ps		
Cumulative error across 10 cycles	tERR(10per)	-160	160	-137	137	-120	120	-107	107	ps		
Cumulative error across 11 cycles	tERR(11per)	-164	164	-141	141	-123	123	-110	110	ps		
Cumulative error across 12 cycles	tERR(12per)	-168	168	-144	144	-126	126	-112	112	ps		
Cumulative error across 13 cycles	tERR(13per)	-172	172	-147	147	-129	129	-114	114	ps		
Cumulative error across 14 cycles	tERR(14per)	-175	175	-150	150	-131	131	-116	116	ps		
Cumulative error across 15 cycles	tERR(15per)	-178	178	-152	152	-133	133	-118	118	ps		
Cumulative error across 16 cycles	tERR(16per)	-180	189	-155	155	-135	135	-120	120	ps		
Cumulative error across 17 cycles	tERR(17per)	-183	183	-157	157	-137	137	-122	122	ps		
Cumulative error across 18 cycles	tERR(18per)	-185	185	-159	159	-139	139	-124	124	ps		
Cumulative error across n = 13, 14, ... 49, 50 cycles	tERR(nper)	$tERR(nper)min = ((1 + 0.68ln(n)) * tJIT(per)_total min)$ $tERR(nper)max = ((1 + 0.68ln(n)) * tJIT(per)_total max)$									ps	
Command and Address setup time to CK_t, CK_c referenced to Vih(ac) / Vil(ac) levels	tIS(base)	115	-	100	-	80	-	62	-	ps		
Command and Address setup time to CK_t, CK_c referenced to Vref levels	tIS(Vref)	215	-	200	-	180	-	162	-	ps		
Command and Address hold time to CK_t, CK_c referenced to Vih(dc) / Vil(dc) levels	tIH(base)	140	-	125	-	105	-	87	-	ps		
Command and Address hold time to CK_t, CK_c referenced to Vref levels	tIH(Vref)	215	-	200	-	180	-	162	-	ps		
Control and Address Input pulse width for each input	tIPW	600	-	525	-	460	-	410	-	ps		

Speed		DDR4-1600		DDR4-1866		DDR4-2133		DDR4-2400		Units	NOTE
Parameter	Symbol	MIN	MAX	MIN	MAX	MIN	MAX	MIN	MAX		
Command and Address Timing											
CAS _n to CAS _n command delay for same bank group	tCCD_L	max(5 nCK, 6.250 ns)	-	max(5 nCK, 5.355 ns)	-	max(5 nCK, 5.355 ns)	-	max(5 nCK, 5 ns)	-	nCK	34
CAS _n to CAS _n command delay for different bank group	tCCD_S	4	-	4	-	4	-	4	-	nCK	34
ACTIVATE to ACTIVATE Command delay to different bank group for 2KB page size	tRRD_S(2K)	Max(4nCK,6ns)	-	Max(4nCK,5.3ns)	-	Max(4nCK,5.3ns)	-	Max(4nCK,5.3ns)	-	nCK	34
ACTIVATE to ACTIVATE Command delay to different bank group for 2KB page size	tRRD_S(1K)	Max(4nCK,5ns)	-	Max(4nCK,4.2ns)	-	Max(4nCK,3.7ns)	-	Max(4nCK,3.3ns)	-	nCK	34
ACTIVATE to ACTIVATE Command delay to different bank group for 1/2KB page size	tRRD_S(1/2K)	Max(4nCK,5ns)	-	Max(4nCK,4.2ns)	-	Max(4nCK,3.7ns)	-	Max(4nCK,3.3ns)	-	nCK	34
ACTIVATE to ACTIVATE Command delay to same bank group for 2KB page size	tRRD_L(2K)	Max(4nCK,7.5ns)	-	Max(4nCK,6.4ns)	-	Max(4nCK,6.4ns)	-	Max(4nCK,6.4ns)	-	nCK	34
ACTIVATE to ACTIVATE Command delay to same bank group for 1KB page size	tRRD_L(1K)	Max(4nCK,6ns)	-	Max(4nCK,5.3ns)	-	Max(4nCK,5.3ns)	-	Max(4nCK,4.9ns)	-	nCK	34
ACTIVATE to ACTIVATE Command delay to same bank group for 1/2KB page size	tRRD_L(1/2K)	Max(4nCK,6ns)	-	Max(4nCK,5.3ns)	-	Max(4nCK,5.3ns)	-	Max(4nCK,4.9ns)	-	nCK	34
Four activate window for 2KB page size	tFAW_2K	Max(28nCK,35ns)	-	Max(28nCK,30ns)	-	Max(28nCK,30ns)	-	Max(28nCK,30ns)	-	ns	34
Four activate window for 1KB page size	tFAW_1K	Max(20nCK,25ns)	-	Max(20nCK,23ns)	-	Max(20nCK,21ns)	-	Max(20nCK,21ns)	-	ns	34
Four activate window for 1/2KB page size	tFAW_1/2K	Max(16nCK,20ns)	-	Max(16nCK,17ns)	-	Max(16nCK,17ns)	-	Max(16nCK,13ns)	-	ns	34
Delay from start of internal write transaction to internal read command for different bank group	tWTR_S	max(2nCK,2.5ns)	-	max(2nCK,2.5ns)	-	max(2nCK,2.5ns)	-	max(2nCK,2.5ns)	-		1,2,e,34
Delay from start of internal write transaction to internal read command for same bank group	tWTR_L	max(4nCK,7.5ns)	-	max(4nCK,7.5ns)	-	max(4nCK,7.5ns)	-	max(4nCK,7.5ns)	-		1,34
Internal READ Command to PRE-CHARGE Command delay	tRTP	max(4nCK,7.5ns)	-	max(4nCK,7.5ns)	-	max(4nCK,7.5ns)	-	max(4nCK,7.5ns)	-		
WRITE recovery time	tWR	15	-	15	-	15	-	15	-	ns	1
Write recovery time when CRC and DM are enabled	tWR_CRC_DM	tWR+max(4nCK,3.75ns)	-	tWR+max(5nCK,3.75ns)	-	tWR+max(5nCK,3.75ns)	-	tWR+max(5nCK,3.75ns)	-	ns	1,28
delay from start of internal write transaction to internal read command for different bank group with both CRC and DM enabled	tWTR_S_CRC_DM	tWTR_S+max(4nCK,3.75ns)	-	tWTR_S+max(5nCK,3.75ns)	-	tWTR_S+max(5nCK,3.75ns)	-	tWTR_S+max(5nCK,3.75ns)	-	ns	2,29,34
delay from start of internal write transaction to internal read command for same bank group with both CRC and DM enabled	tWTR_L_CRC_DM	tWTR_L+max(4nCK,3.75ns)	-	tWTR_L+max(5nCK,3.75ns)	-	tWTR_L+max(5nCK,3.75ns)	-	tWTR_L+max(5nCK,3.75ns)	-	ns	3,30,34
DLL locking time	tDLLK	597	-	597	-	768	-	768	-	nCK	
Mode Register Set command cycle time	tMRD	8	-	8	-	8	-	8	-	nCK	
Mode Register Set command update delay	tMOD	max(24nCK,15ns)	-	max(24nCK,15ns)	-	max(24nCK,15ns)	-	max(24nCK,15ns)	-		
Multi-Purpose Register Recovery Time	tMPRR	1	-	1	-	1	-	1	-	nCK	33
Multi Purpose Register Write Recovery Time	tWR_MPR	tMOD (min) + AL + PL	-	tMOD (min) + AL + PL	-	tMOD (min) + AL + PL	-	tMOD (min) + AL + PL	-	-	
Auto precharge write recovery + precharge time	tDAL(min)	Programmed WR + roundup (tRP / tCK(avg))								nCK	
DQ0 or DQL0 driven to 0 set-up time to first DQS rising edge	tPDA_S	0.5	-	0.5	-	0.5	-	0.5	-	UI	45,47
DQ0 or DQL0 driven to 0 hold time from last DQS fall-ing edge	tPDA_H	0.5	-	0.5	-	0.5	-	0.5	-	UI	46,47
CS_n to Command Address Latency											
CS _n to Command Address Latency	tCAL	3	-	4	-	4	-	5	-	nCK	
DRAM Data Timing											
DQS _t ,DQS _c to DQ skew, per group, per access	tDQSQ	-	0.16	-	0.16	-	0.16	-	0.16	tCK(avg)/2	13,18
DQ output hold time from DQS _t ,DQS _c	tQH	0.76	-	0.76	-	0.76	-	0.76	-	tCK(avg)/2	13,17,18

Speed		DDR4-1600		DDR4-1866		DDR4-2133		DDR4-2400		Units	NOTE
Parameter	Symbol	MIN	MAX	MIN	MAX	MIN	MAX	MIN	MAX		
Data Valid Window per device: tQH - tDQSQ for a device	tDVWd	0.63	-	0.63	-	0.64	-	0.64	-	UI	16,17,18
Data Valid Window per device, per pin: tQH - tDQSQ each device's output	tDVWp	0.66	-	0.66	-	0.69	-	0.72	-	UI	16,17,18
Data Strobe Timing											
DQS_t, DQS_c differential READ Preamble	tRPRE	0.9	NOTE44	0.9	NOTE44	0.9	NOTE44	0.9	NOTE44	tCK	40
		NA	NA	NA	NA	NA	NA	1.8	NOTE44	tCK	41
DQS_t, DQS_c differential READ Postamble	tRPST	0.33	TBD	0.33	TBD	0.33	TBD	0.33	TBD	tCK	
DQS_t, DQS_c differential output high time	tQSH	0.4	-	0.4	-	0.4	-	0.4	-	tCK	21
DQS_t, DQS_c differential output low time	tQSL	0.4	-	0.4	-	0.4	-	0.4	-	tCK	20
DQS_t, DQS_c differential WRITE Preamble	tWPRE	0.9	-	0.9	-	0.9	-	0.9	-	tCK	42
		NA	NA	NA	NA	NA	NA	1.8	NA	tCK	43
DQS_t, DQS_c differential WRITE Postamble	tWPST	0.33	TBD	0.33	TBD	0.33	TBD	0.33	TBD	tCK	
DQS_t and DQS_c low-impedance time (Referenced from RL-1)	tLZ(DQS)	-450	225	-390	195	-360	180	-300	150	ps	
DQS_t and DQS_c high-impedance time (Referenced from RL+BL/2)	tHZ(DQS)	-	225	-	195	-	180	-	150	ps	
DQS_t, DQS_c differential input low pulse width	tDQSL	0.46	0.54	0.46	0.54	0.46	0.54	0.46	0.54	tCK	
DQS_t, DQS_c differential input high pulse width	tDQSH	0.46	0.54	0.46	0.54	0.46	0.54	0.46	0.54	tCK	
DQS_t, DQS_c rising edge to CK_t, CK_c rising edge (1 clock preamble)	tDQSS	-0.27	0.27	-0.27	0.27	-0.27	0.27	-0.27	0.27	tCK	
DQS_t, DQS_c falling edge setup time to CK_t, CK_c rising edge	tDSS	0.18	-	0.18	-	0.18	-	0.18	-	tCK	
DQS_t, DQS_c falling edge hold time from CK_t, CK_c rising edge	tDSH	0.18	-	0.18	-	0.18	-	0.18	-	tCK	
DQS_t, DQS_c rising edge output timing locatino from rising CK_t, CK_c with DLL On mode	tDQSCK (DLL On)	-225	225	-195	195	-180	180	-175	175	ps	37,38,39
DQS_t, DQS_c rising edge output variance window per DRAM	tDQSCKI (DLL On)		370		330		310		290	ps	37,38,39
MPSM Timing											
Command path disable delay upon MPSM entry	tMPED	tMOD(min) + tCPDED(min)	-	tMOD(min) + tCPDED(min)	-	tMOD(min) + tCPDED(min)	-	tMOD(min) + tCPDED(min)	-		
Valid clock requirement after MPSM entry	tCKMPE	tMOD(min) + tCPDED(min)	-	tMOD(min) + tCPDED(min)	-	tMOD(min) + tCPDED(min)	-	tMOD(min) + tCPDED(min)	-		
Valid clock requirement before MPSM exit	tCKMPX	tCKSRX(min)		tCKSRX(min)		tCKSRX(min)		tCKSRX(min)			
Exit MPSM to commands not requiring a locked DLL	tXMP	txs(imin)		txs(imin)		txs(imin)		txs(imin)			
Exit MPSM to commands requiring a locked DLL	tXMPDLL	tXMP(min) + tXSDLL(min)		tXMP(min) + tXSDLL(min)		tXMP(min) + tXSDLL(min)		tXMP(min) + tXSDLL(min)			
CS setup time to CKE	tMPX_S	tISmin + tIH-min	-	tISmin + tIH-min	-	tISmin + tIH-min	-	tISmin + tIH-min	-		
Calibration Timing											
Power-up and RESET calibration time	tZQinit	1024	-	1024	-	1024	-	1024	-	nCK	
Normal operation Full calibration time	tZQoper	512	-	512	-	512	-	512	-	nCK	
Normal operation Short calibration time	tZQCS	128	-	128	-	128	-	128	-	nCK	
Reset/Self Refresh Timing											
Exit Reset from CKE HIGH to a valid command	tXPR	max (5nCK, tRFC(min)+10ns)	-	max (5nCK, tRFC(min)+10ns)	-	max (5nCK, tRFC(min)+10ns)	-	max (5nCK, tRFC(min)+10ns)	-		
Exit Self Refresh to commands not requiring a locked DLL	tXS	tRFC(min)+10ns	-	tRFC(min)+10ns	-	tRFC(min)+10ns	-	tRFC(min)+10ns	-		

Speed		DDR4-1600		DDR4-1866		DDR4-2133		DDR4-2400		Units	NOTE
Parameter	Symbol	MIN	MAX	MIN	MAX	MIN	MAX	MIN	MAX		
SRX to commands not requiring a locked DLL in Self Refresh ABORT	tX-S_ABORT(min)	tRFC4(min)+10ns	-	tRFC4(min)+10ns	-	tRFC4(min)+10ns	-	tRFC4(min)+10ns	-		
Exit Self Refresh to ZQCL, ZQCS and MRS (CL, CWL, WR, RTP and Gear Down)	tXS_FAST(min)	tRFC4(min)+10ns	-	tRFC4(min)+10ns	-	tRFC4(min)+10ns	-	tRFC4(min)+10ns	-		
Exit Self Refresh to commands requiring a locked DLL	tXSDLL	tDLLK(min)	-	tDLLK(min)	-	tDLLK(min)	-	tDLLK(min)	-		
Minimum CKE low width for Self refresh entry to exit timing	tCKESR	tCKE(min)+1nCK	-	tCKE(min)+1nCK	-	tCKE(min)+1nCK	-	tCKE(min)+1nCK	-		
Minimum CKE low width for Self refresh entry to exit timing with CA Parity enabled	tCKESR_PAR	tCKE(min)+1nCK+PL	-	tCKE(min)+1nCK+PL	-	tCKE(min)+1nCK+PL	-	tCKE(min)+1nCK+PL	-		
Valid Clock Requirement after Self Refresh Entry (SRE) or Power-Down Entry (PDE)	tCKSRE	max(5nCK, 10ns)	-	max(5nCK, 10ns)	-	max(5nCK, 10ns)	-	max(5nCK, 10ns)	-		
Valid Clock Requirement after Self Refresh Entry (SRE) or Power-Down when CA Parity is enabled	tCKS-RE_PAR	max(5nCK, 10ns)+PL	-	max(5nCK, 10ns)+PL	-	max(5nCK, 10ns)+PL	-	max(5nCK, 10ns)+PL	-		
Valid Clock Requirement before Self Refresh Exit (SRX) or Power-Down Exit (PDX) or Reset Exit	tCKSRX	max(5nCK, 10ns)	-	max(5nCK, 10ns)	-	max(5nCK, 10ns)	-	max(5nCK, 10ns)	-		
Power Down Timing											
Exit Power Down with DLL on to any valid command; Exit Precharge Power Down with DLL frozen to commands not requiring a locked DLL	tXP	max(4nCK, 6ns)	-	max(4nCK, 6ns)	-	max(4nCK, 6ns)	-	max(4nCK, 6ns)	-		
CKE minimum pulse width	tCKE	max(3nCK, 5ns)	-	max(3nCK, 5ns)	-	max(3nCK, 5ns)	-	max(3nCK, 5ns)	-		31,32
Command pass disable delay	tCPDED	4	-	4	-	4	-	4	-	nCK	
Power Down Entry to Exit Timing	tPD	tCKE(min)	9*tREFI	tCKE(min)	9*tREFI	tCKE(min)	9*tREFI	tCKE(min)	9*tREFI		6
Timing of ACT command to Power Down entry	tACTPDEN	1	-	1	-	2	-	2	-	nCK	7
Timing of PRE or PREA command to Power Down entry	tPRPDEN	1	-	1	-	2	-	2	-	nCK	7
Timing of RD/RDA command to Power Down entry	tRDPDEN	RL+4+1	-	RL+4+1	-	RL+4+1	-	RL+4+1	-	nCK	
Timing of WR command to Power Down entry (BL8OTF, BL8MRS, BC4OTF)	tWRPDEN	WL+4+(tWR/tCK(avg))	-	WL+4+(tWR/tCK(avg))	-	WL+4+(tWR/tCK(avg))	-	WL+4+(tWR/tCK(avg))	-	nCK	4
Timing of WRA command to Power Down entry (BL8OTF, BL8MRS, BC4OTF)	tWRAPDEN	WL+4+WR+1	-	WL+4+WR+1	-	WL+4+WR+1	-	WL+4+WR+1	-	nCK	5
Timing of WR command to Power Down entry (BC4MRS)	tWRP-BC4DEN	WL+2+(tWR/tCK(avg))	-	WL+2+(tWR/tCK(avg))	-	WL+2+(tWR/tCK(avg))	-	WL+2+(tWR/tCK(avg))	-	nCK	4
Timing of WRA command to Power Down entry (BC4MRS)	tWRAP-BC4DEN	WL+2+WR+1	-	WL+2+WR+1	-	WL+2+WR+1	-	WL+2+WR+1	-	nCK	5
Timing of REF command to Power Down entry	tREFPDEN	1	-	1	-	2	-	2	-	nCK	7
Timing of MRS command to Power Down entry	tMRSPDEN	tMOD(min)	-	tMOD(min)	-	tMOD(min)	-	tMOD(min)	-		
PDA Timing											
Mode Register Set command cycle time in PDA mode	tMRD_PDA	max(16nCK, 10ns)		max(16nCK, 10ns)		max(16nCK, 10ns)		max(16nCK, 10ns)			
Mode Register Set command update delay in PDA mode	tMOD_PDA	tMOD		tMOD		tMOD		tMOD			
ODT Timing											
Asynchronous RTT turn-on delay (Power-Down with DLL frozen)	tAONAS	1.0	9.0	1.0	9.0	1.0	9.0	1.0	9.0	ns	
Asynchronous RTT turn-off delay (Power-Down with DLL frozen)	tAOFAS	1.0	9.0	1.0	9.0	1.0	9.0	1.0	9.0	ns	
RTT dynamic change skew	tADC	0.3	0.7	0.3	0.7	0.3	0.7	0.3	0.7	tCK(avg)	
Write Leveling Timing											
First DQS_t/DQS_n rising edge after write leveling mode is programmed	tWLMRD	40	-	40	-	40	-	40	-	nCK	12
DQS_t/DQS_n delay after write leveling mode is programmed	tWLDQSEN	25	-	25	-	25	-	25	-	nCK	12
Write leveling setup time from rising CK_t, CK_c crossing to rising DQS_t/DQS_n crossing	tWLS	0.13	-	0.13	-	0.13	-	0.13	-	tCK(avg)	

Speed		DDR4-1600		DDR4-1866		DDR4-2133		DDR4-2400		Units	NOTE
Parameter	Symbol	MIN	MAX	MIN	MAX	MIN	MAX	MIN	MAX		
Write leveling hold time from rising DQS_t/DQS_n crossing to rising CK_t, CK_crossing	tWLH	0.13	-	0.13	-	0.13	-	0.13	-	tCK(avg)	
Write leveling output delay	tWLO	0	9.5	0	9.5	0	9.5	0	9.5	ns	
Write leveling output error	tWLOE									ns	
CA Parity Timing											
Commands not guaranteed to be executed during this time	tPAR_UNKNOWN	-	PL	-	PL	-	PL	-	PL		
Delay from errant command to ALERT_n assertion	tPAR_ALERT_ON	-	PL+6ns	-	PL+6ns	-	PL+6ns	-	PL+6ns		
Pulse width of ALERT_n signal when asserted	tPAR_ALERT_PW	48	96	56	112	64	128	72	144	nCK	
Time from when Alert is asserted till controller must start providing DES commands in Persistent CA parity mode	tPAR_ALERT_RSP	-	43	-	50	-	57	-	64	nCK	
Parity Latency	PL	4		4		4		5		nCK	
CRC Error Reporting											
CRC error to ALERT_n latency	tCRC_ALERT_T	3	13	3	13	3	13	3	13	ns	
CRC ALERT_n pulse width	CRC_ALERT_PW	6	10	6	10	6	10	6	10	nCK	
tREFI											
trFC1 (min)	2Gb	160	-	160	-	160	-	160	-	ns	34
	4Gb	260	-	260	-	260	-	260	-	ns	34
	8Gb	350	-	350	-	350	-	350	-	ns	34
	16Gb	TBD	-	TBD	-	TBD	-	TBD	-	ns	34
trFC2 (min)	2Gb	110	-	110	-	110	-	110	-	ns	34
	4Gb	160	-	160	-	160	-	160	-	ns	34
	8Gb	260	-	260	-	260	-	260	-	ns	34
	16Gb	TBD	-	TBD	-	TBD	-	TBD	-	ns	34
trFC4 (min)	2Gb	90	-	90	-	90	-	90	-	ns	34
	4Gb	110	-	110	-	110	-	110	-	ns	34
	8Gb	160	-	160	-	160	-	160	-	ns	34
	16Gb	TBD	-	TBD	-	TBD	-	TBD	-	ns	34

NOTE :

1. Start of internal write transaction is defined as follows :
For BL8 (Fixed by MRS and on-the-fly) : Rising clock edge 4 clock cycles after WL.
For BC4 (on-the-fly) : Rising clock edge 4 clock cycles after WL.
For BC4 (fixed by MRS) : Rising clock edge 2 clock cycles after WL.
2. A separate timing parameter will cover the delay from write to read when CRC and DM are simultaneously enabled
3. Commands requiring a locked DLL are: READ (and RAP) and synchronous ODT commands.
4. tWR is defined in ns, for calculation of tWRPDEN it is necessary to round up tWR/tCK to the next integer.
5. WR in clock cycles as programmed in MR0.
6. tREFI depends on TOPER.
7. CKE is allowed to be registered low while operations such as row activation, precharge, autoprecharge or refresh are in progress, but power-down IDD spec will not be applied until finishing those operations.
8. For these parameters, the DDR4 SDRAM device supports $t_nPARAM[nCK]=RU\{tPARAM[ns]/tCK(avg)[ns]\}$, which is in clock cycles assuming all input clock jitter specifications are satisfied
9. When CRC and DM are both enabled, tWR_CRC_DM is used in place of tWR.
10. When CRC and DM are both enabled tWTR_S_CRC_DM is used in place of tWTR_S.
11. When CRC and DM are both enabled tWTR_L_CRC_DM is used in place of tWTR_L.
12. The max values are system dependent.
13. DQ to DQS total timing per group where the total includes the sum of deterministic and random timing terms for a specified BER. BER spec and measurement method are tbd.
14. The deterministic component of the total timing. Measurement method tbd.
15. DQ to DQ static offset relative to strobe per group. Measurement method tbd.
16. This parameter will be characterized and guaranteed by design.
17. When the device is operated with the input clock jitter, this parameter needs to be derated by the actual tjit(per)_total of the input clock. (output deratings are relative to the SDRAM input clock). Example tbd.
18. DRAM DBI mode is off.
19. DRAM DBI mode is enabled. Applicable to x8 and x16 DRAM only.
20. tQSL describes the instantaneous differential output low pulse width on DQS_t - DQS_c, as measured from on falling edge to the next consecutive rising edge
21. tQSH describes the instantaneous differential output high pulse width on DQS_t - DQS_c, as measured from on falling edge to the next consecutive rising edge
22. There is no maximum cycle time limit besides the need to satisfy the refresh interval tREFI
23. tCH(abs) is the absolute instantaneous clock high pulse width, as measured from one rising edge to the following falling edge
24. tCL(abs) is the absolute instantaneous clock low pulse width, as measured from one falling edge to the following rising edge
25. Total jitter includes the sum of deterministic and random jitter terms for a specified BER. BER target and measurement method are tbd.
26. The deterministic jitter component out of the total jitter. This parameter is characterized and guaranteed by design.
27. This parameter has to be even number of clocks
28. When CRC and DM are both enabled, tWR_CRC_DM is used in place of tWR.
29. When CRC and DM are both enabled tWTR_S_CRC_DM is used in place of tWTR_S.
30. When CRC and DM are both enabled tWTR_L_CRC_DM is used in place of tWTR_L.
31. After CKE is registered LOW, CKE signal level shall be maintained below VILDC for tCKE specification (Low pulse width).
32. After CKE is registered HIGH, CKE signal level shall be maintained above VIHDC for tCKE specification (HIGH pulse width).
33. Defined between end of MPR read burst and MRS which reloads MPR or disables MPR function.
34. Parameters apply from tCK(avg)min to tCK(avg)max at all standard JEDEC clock period values as stated in the Speed Bin Tables.
35. This parameter must keep consistency with Speed-Bin Tables shown in Device Operation.
36. DDR4-1600 AC timing apply if DRAM operates at lower than 1600 MT/s data rate.
 $UI=tCK(avg).min/2$
37. applied when DRAM is in DLL ON mode.
38. Assume no jitter on input clock signals to the DRAM
39. Value is only valid for RZQ/7
40. 1tCK toggle mode with setting MR4:A11 to 0
41. 2tCK toggle mode with setting MR4:A11 to 1, which is valid for DDR4-2400 speed grade.
42. 1tCK mode with setting MR4:A12 to 0
43. 2tCK mode with setting MR4:A12 to 1, which is valid for DDR4-2400 speed grade.
44. The maximum read preamble is bounded by tLZ(DQS)min on the left side and tDQSK(max) on the right side. See Device Operation.
to Data Strobe Relationship". Boundary of DQS Low-Z occur one cycle earlier in 2tCK toggle mode which is illustrated in See Device Operation Preamble".
45. DQ falling signal middle-point of transferring from High to Low to first rising edge of DQS diff-signal cross-point
46. last falling edge of DQS diff-signal cross-point to DQ rising signal middle-point of transferring from Low to High
47. VrefDQ value must be set to either its midpoint or Vcent_DQ(midpoint) in order to capture DQ0 or DQL0 low level for entering PDA mode.

15. Physical Dimensions

15.1 1Gx8 based 1Gx64 Module (1 Rank) - M378A1K43BB1

Units : Millimeters

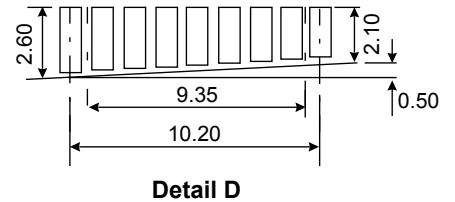
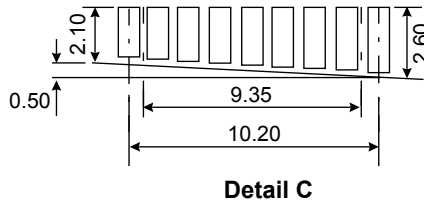
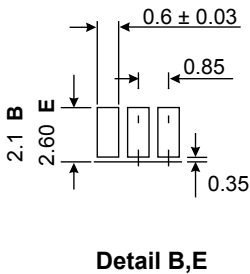
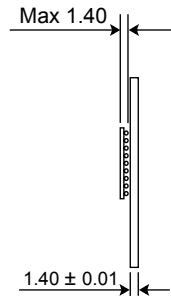
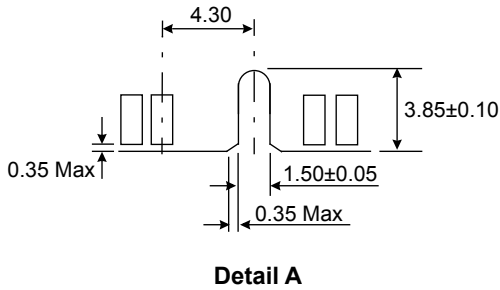
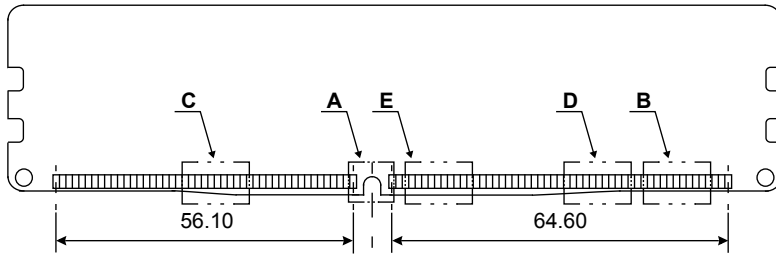
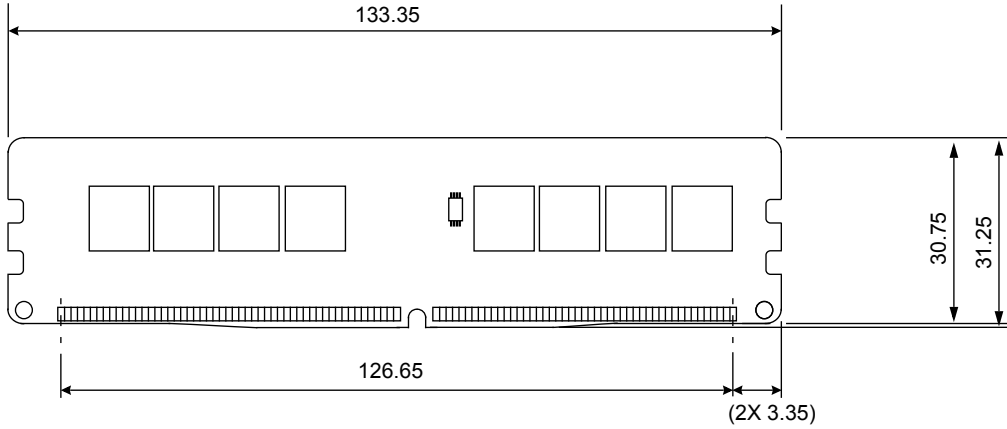

The used device is 1G x8 DDR4 SDRAM, FBGA.
 DDR4 SDRAM Part NO : K4A8G085WB-BC**

* **NOTE** : Tolerances on all dimensions ±0.15 unless otherwise specified.

15.2 1Gx8 based 1Gx64 Module (1 Rank) - M378A1K43BB2

Units : Millimeters

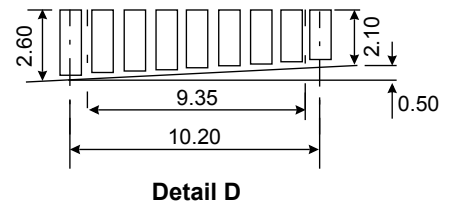
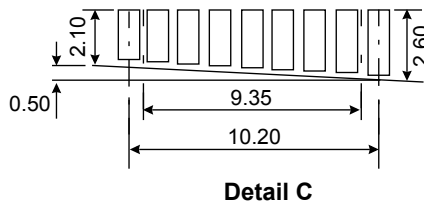
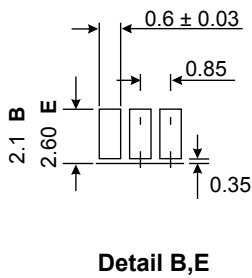
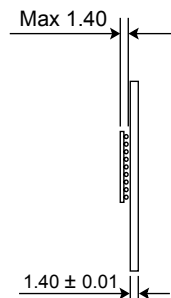
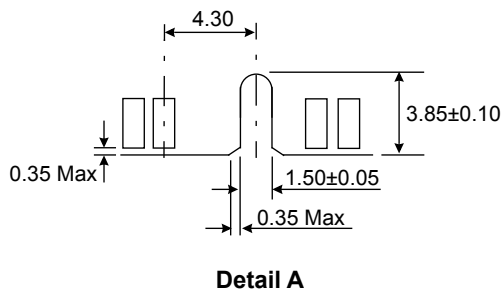
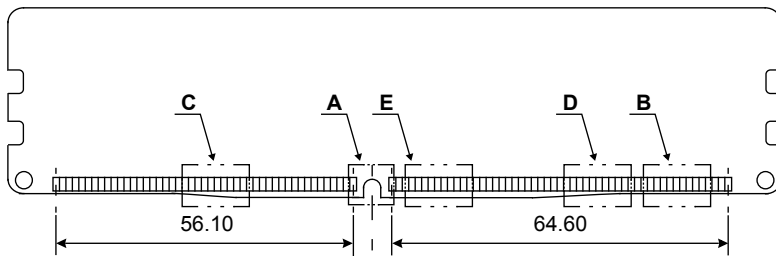
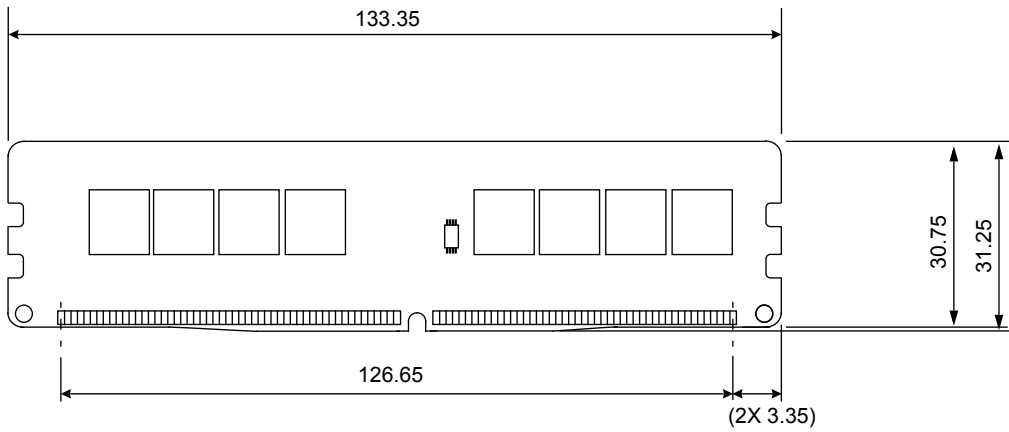

The used device is 1G x8 DDR4 SDRAM, FBGA.
 DDR4 SDRAM Part NO : K4A8G085WB-BC**

* **NOTE** : Tolerances on all dimensions ±0.15 unless otherwise specified.

15.3 1Gx8 based 2Gx64 Module (2 Ranks) - M378A2K43BB1

Units : Millimeters

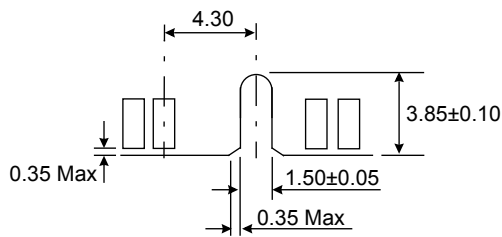
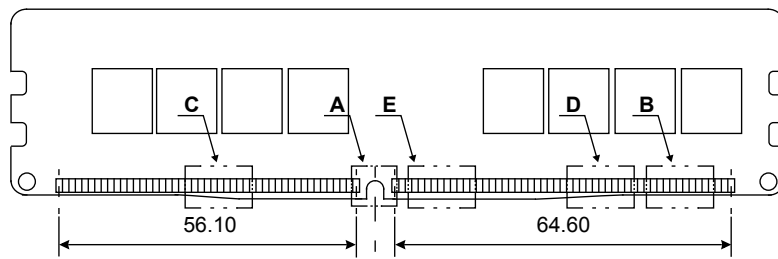
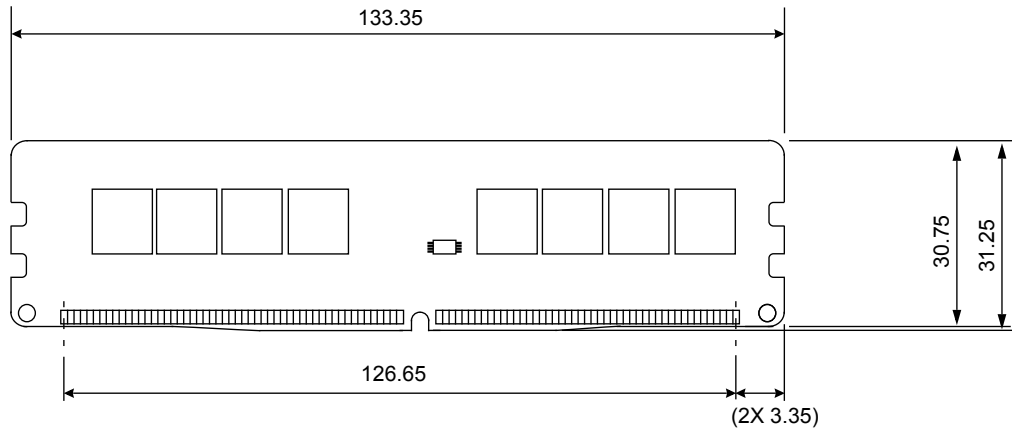

Detail A

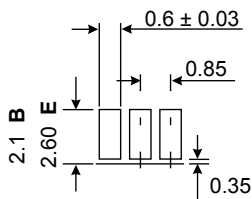
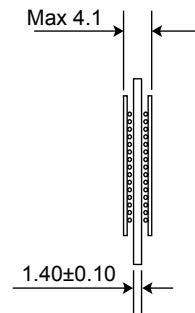

Detail B,E

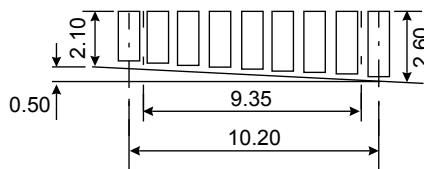

Detail C

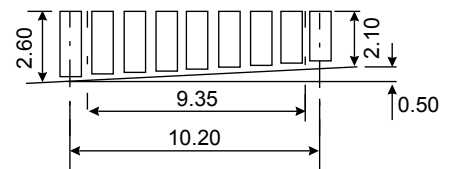

Detail D

The used device is 1G x8 DDR4 SDRAM, FBGA.
 DDR4 SDRAM Part NO : K4A8G085WB-BC**

* NOTE : Tolerances on all dimensions ±0.15 unless otherwise specified.

15.4 1Gx8 based 2Gx72 Module (2 Ranks) - M391A2K43BB1

Units : Millimeters

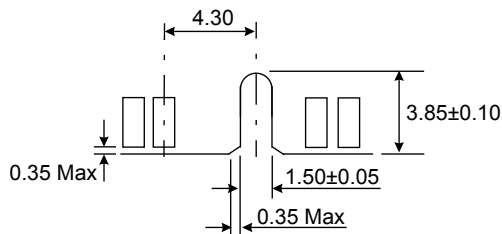
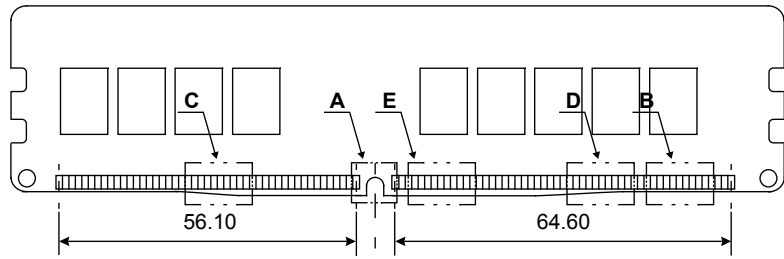
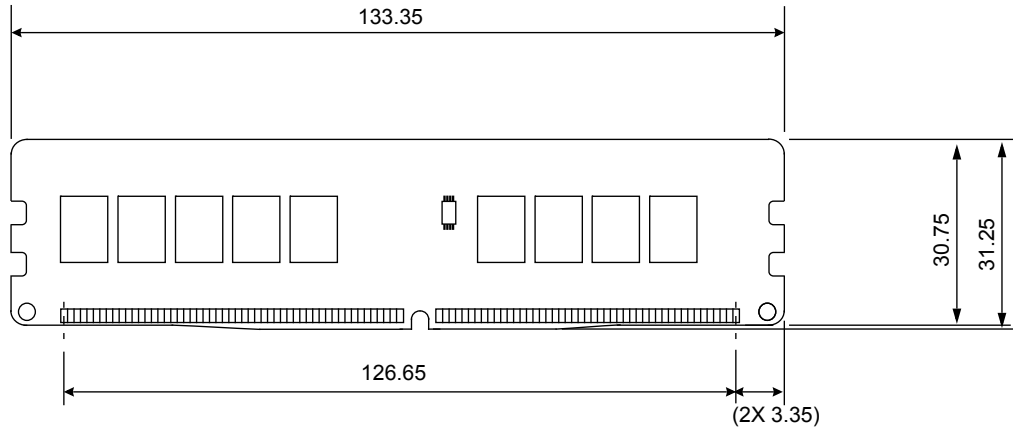

Detail A

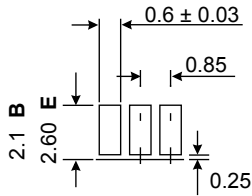
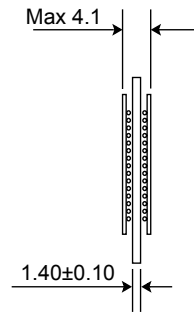

Detail B,E

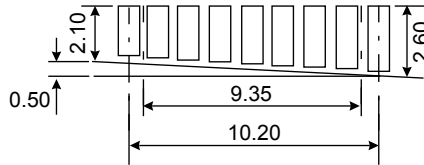

Detail C

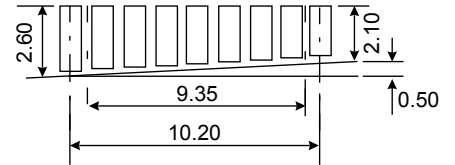

Detail D

The used device is 1G x8 DDR4 SDRAM, FBGA.
 DDR4 SDRAM Part NO : K4A8G085WB-BC**

* NOTE : Tolerances on all dimensions ±0.15 unless otherwise specified.