

0.14 GHz to 1.5 GHz QUADRATURE MODULATOR

FEATURES

- P1dB of 7 dBm
- –156 dBm/Hz Noise Floor
- –150 dBm/Hz Noise at $P_{OUT} = 0$ dBm
- Typical Unadjusted Carrier Suppression > 35 dBc at 1 GHz
- Typical Unadjusted Sideband Suppression > 40 dBc at 1 GHz
- Differential or Single-Ended I, Q Inputs
- Convenient Single-Ended LO Input
- Silicon Germanium Technology

APPLICATIONS

- Cellular Base Transceiver Station Transmit Channel
- IF Sampling Applications
- TDMA: GSM, IS-136, EDGE/UWC-136
- CDMA: IS-95, UMTS, CDMA2000
- Wireless Local Loop
- Wireless LAN IEEE 802.11
- LMDS, MMDS
- Wideband Baseband Transceivers

DESCRIPTION

The TRF3701 is an ultralow-noise direct quadrature modulator that is capable of converting complex input signals from baseband or IF directly up to RF. An internal analog combiner sums the real and imaginary components of the RF outputs. This combined output can feed the RF preamp directly at frequencies of up to 1.5 GHz. The modulator is implemented as a double-balanced mixer. An internal local oscillator (LO) phase splitter accommodates a single-ended LO input, eliminating the need for a costly external balun.

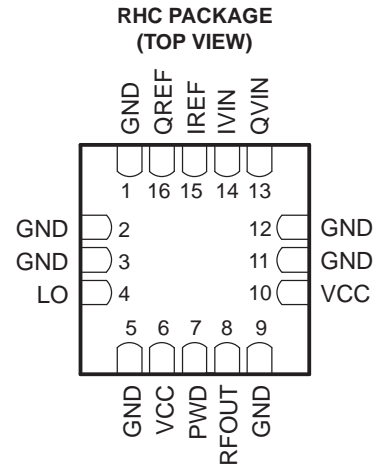

P0003-01

AVAILABLE OPTIONS

T_A	4-mm × 4-mm 16-Pin RHC (QFN) Package
–40°C to 85°C	TRF3701IRHC
	TRF3701IRHCR (Tape and Reel)



Please be aware that an important notice concerning availability, standard warranty, and use in critical applications of Texas Instruments semiconductor products and disclaimers thereto appears at the end of this data sheet.



This integrated circuit can be damaged by ESD. Texas Instruments recommends that all integrated circuits be handled with appropriate precautions. Failure to observe proper handling and installation procedures can cause damage.

ESD damage can range from subtle performance degradation to complete device failure. Precision integrated circuits may be more susceptible to damage because very small parametric changes could cause the device not to meet its published specifications.

FUNCTIONAL BLOCK DIAGRAM

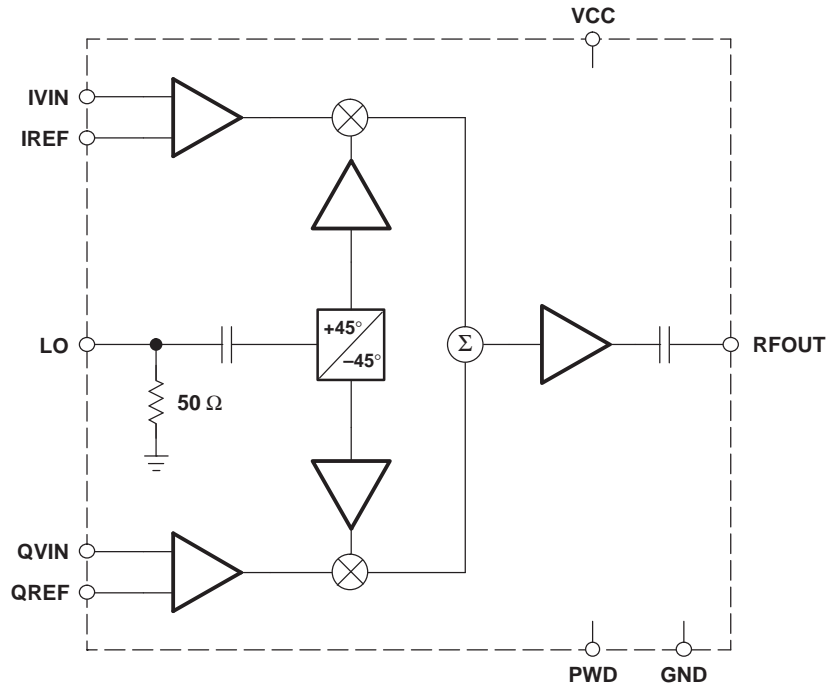

B0002-01

Table 1. TERMINAL FUNCTIONS

TERMINAL		I/O	DESCRIPTION
NAME	NO.		
GND	1, 2, 3, 5, 9, 11, 12		Ground
IREF	15	I	In-phase (I) reference voltage/differential input
IVIN	14	I	In-phase (I) signal input
LO	4	I	Local oscillator input
PWD	7	I	Power down
QREF	16	I	Quadrature (Q) reference voltage/differential input
QVIN	13	I	Quadrature (Q) signal input
RFOUT	8	O	RF output
VCC	6, 10		Supply voltage

ABSOLUTE MAXIMUM RATINGS

 over operating free-air temperature range (unless otherwise noted)⁽¹⁾⁽²⁾

V_{CC}	Supply voltage range	–0.5 V to 6 V
	LO input power level	10 dBm
	Baseband input voltage level (single-ended)	3 Vp-p
T_A	Operating free-air temperature range	–40°C to 85°C
	Lead temperature for 10 seconds	260°C

- (1) Stresses beyond those listed under "absolute maximum ratings" may cause permanent damage to the device. These are stress ratings only, and functional operation of the device at these or any other conditions beyond those indicated under "recommended operating conditions" is not implied. Exposure to absolute-maximum-rated conditions for extended periods may affect device reliability.
- (2) Measured with respect to ground

RECOMMENDED OPERATING CONDITIONS

		MIN	NOM	MAX	UNIT
Supplies and References					
V_{CC}	Analog supply voltage	4.5	5	5.5	V
	VCM (IVIN, QVIN, IREF, QREF input common-mode dc voltage)		3.7		V
Local Oscillator Input (LO)					
	Input frequency	140		1500	MHz
	Power level (measured into 50 Ω)	–6	0	6	dBm
Signal Inputs (IVIN, QVIN)					
	Input bandwidth		700		MHz
PWD Operation	V_{IL}		0	1.2	V
	V_{IH}	3.7	5		

ELECTRICAL CHARACTERISTICS

 Over recommended operating conditions, $V_{CC} = 5$ V, $V_{CM} = 3.7$ V, $f_{LO} = 942.5$ MHz at 0 dBm, $T_A = 25^\circ\text{C}$ (unless otherwise noted)

PARAMETER	TEST CONDITIONS	MIN	TYP	MAX	UNIT
Power Supply					
I_{CC} Total supply current	$V(\text{PWD}) = 5$ V		145		mA
	$V(\text{PWD}) = 0$ V		13		
Power-down input impedance			11		k Ω
Turnon time			120		ns
Turnoff time			20		ns
Local Oscillator (LO) Input					
Input impedance			40 + j4.8		Ω
Signal Inputs (IVIN, QVIN, IREF, QREF)					
Input bias current	$V(\text{IVIN}) = V(\text{IREF}) = V(\text{QVIN}) = V(\text{QREF}) = V_{CM} = 3.7$ V		16		μA
Input impedance	Single-ended input		250		k Ω
	Differential input		125		

RF OUTPUT PERFORMANCE (942.5 MHz)

Over recommended operating conditions, $V_{CC} = 5\text{ V}$, $V_{CM} = 3.7\text{ V}$, $f_{LO} = 942.5\text{ MHz}$ at 0 dBm, $T_A = 25^\circ\text{C}$ (unless otherwise noted)⁽¹⁾

PARAMETER		TEST CONDITIONS	MIN	TYP	MAX	UNIT
Single and Two-Tone Specifications						
Output power			-3.5	-1		dBm
Second baseband harmonic (USB or LSB) ⁽³⁾	I, Q ⁽²⁾ = 1 Vp-p, $f_{BB} = 928\text{ kHz}$			-50	-45	dBc
Third baseband harmonic (USB or LSB) ⁽³⁾				-61	-55	dBc
IMD ₃		I, Q ⁽²⁾ = 1 Vp-p (two-tone signal, $f_{BB1} = 928\text{ kHz}$, $f_{BB2} = 992\text{ kHz}$)		-55	-45	dBc
P1dB (output compression point)				6.5		dBm
NSD Noise spectral density		I, Q ⁽⁴⁾ = VCM = 3.7 VDC		-156		dBm/Hz
		6-MHz offset from carrier, $P_{out} = -10\text{ dBm}$, over temperature		-153	-151 ⁽⁵⁾	
		6-MHz offset from carrier, $P_{out} = -5\text{ dBm}$, over temperature		-152	-150 ⁽⁵⁾	
		6-MHz offset from carrier, $P_{out} = 0\text{ dBm}$, over temperature		-150	-148 ⁽⁵⁾	
RFOUT pin impedance			26 + j3			Ω
Carrier suppression		I, Q ⁽²⁾ = 1 Vp-p, $f_{BB} = 928\text{ kHz}$, unadjusted	30	35		dBc
		I, Q ⁽²⁾ = 1 Vp-p, $f_{BB} = 928\text{ kHz}$, optimized		55		
		I, Q ⁽²⁾ = 1 Vp-p, $f_{BB} = 928\text{ kHz}$, over temperature		35		
Sideband suppression		I, Q ⁽²⁾ = 1 Vp-p, $f_{BB} = 928\text{ kHz}$, unadjusted	37	50		dBc
		I, Q ⁽²⁾ = 1 Vp-p, $f_{BB} = 928\text{ kHz}$, optimized		55		
		I, Q ⁽²⁾ = 1 Vp-p, $f_{BB} = 928\text{ kHz}$, over temperature		38		

(1) Baseband inputs are differential; equivalent performance is attained by using single-ended drive.

(2) I, Q = 1 Vp-p implies that the magnitude of the signal at each input pin IVIN, IREF, QVIN, QREF is equal to 500 mVp-p.

(3) USB = upper sideband. LSB = lower sideband.

(4) All input pins tied to VCM

(5) Maximum noise values are assured by statistical characterization only, not production testing. The values specified are over the entire temperature range, $T_A = -40^\circ\text{C}$ to 85°C .

RF OUTPUT PERFORMANCE (340 MHz)

Over recommended operating conditions, $V_{CC} = 5\text{ V}$, $V_{CM} = 3.7\text{ V}$, $f_{LO} = 340\text{ MHz}$ at 0 dBm, $T_A = 25^\circ\text{C}$ (unless otherwise noted)⁽¹⁾

PARAMETER	TEST CONDITIONS	MIN	TYP	MAX	UNIT
Single and Two-Tone Specifications					
Output power	$I, Q^{(2)} = 1\text{ Vp-p}$, $f_{BB} = 928\text{ kHz}$		-1		dBm
Second baseband harmonic (USB or LSB) ⁽³⁾			-52		dBc
Third baseband harmonic (USB or LSB) ⁽³⁾			-45		dBc
IMD ₃	$I, Q^{(2)} = 1\text{ Vp-p}$ (two-tone signal, $f_{BB1} = 928\text{ kHz}$, $f_{BB2} = 992\text{ kHz}$)		67		dBc
P1dB (output compression point)			6		dBm
Carrier suppression	$I, Q^{(2)} = 1\text{ Vp-p}$, $f_{BB} = 928\text{ kHz}$, unadjusted	40	51		dBc
	$I, Q^{(2)} = 1\text{ Vp-p}$, $f_{BB} = 928\text{ kHz}$, optimized		>60		
Sideband suppression	$I, Q^{(2)} = 1\text{ Vp-p}$, $f_{BB} = 928\text{ kHz}$, unadjusted		35		dBc
	$I, Q^{(2)} = 1\text{ Vp-p}$, $f_{BB} = 928\text{ kHz}$, optimized		>60		

(1) Baseband inputs are differential; equivalent performance is attained by using single-ended drive.

(2) $I, Q = 1\text{ Vp-p}$ implies that the magnitude of the signal at each input pin I_{VIN} , I_{REF} , Q_{VIN} , Q_{REF} is equal to 500 mVp-p.

(3) USB = upper sideband. LSB = lower sideband.

RF OUTPUT PERFORMANCE (140 MHz)

Over recommended operating conditions, $V_{CC} = 5\text{ V}$, $V_{CM} = 3.7\text{ V}$, $f_{LO} = 140\text{ MHz}$ at 0 dBm, $T_A = 25^\circ\text{C}$ (unless otherwise noted)⁽¹⁾

PARAMETER	TEST CONDITIONS	MIN	TYP	MAX	UNIT
Single and Two-Tone Specifications					
Output power	$I, Q^{(2)} = 1\text{ Vp-p}$, $f_{BB} = 928\text{ kHz}$		-1		dBm
Second baseband harmonic (USB or LSB) ⁽³⁾			-61.5		dBc
Third baseband harmonic (USB or LSB) ⁽³⁾			-46		dBc
IMD ₃	$I, Q^{(2)} = 1\text{ Vp-p}$ (two-tone signal, $f_{BB1} = 928\text{ kHz}$, $f_{BB2} = 992\text{ kHz}$)		68		dBc
P1dB (output compression point)			3.6		dBm
Carrier suppression	$I, Q^{(2)} = 1\text{ Vp-p}$, $f_{BB} = 928\text{ kHz}$, unadjusted	40	50		dBc
	$I, Q^{(2)} = 1\text{ Vp-p}$, $f_{BB} = 928\text{ kHz}$, optimized		>60		
Sideband suppression	$I, Q^{(2)} = 1\text{ Vp-p}$, $f_{BB} = 928\text{ kHz}$, unadjusted		35		dBc
	$I, Q^{(2)} = 1\text{ Vp-p}$, $f_{BB} = 928\text{ kHz}$, optimized		>60		

(1) Baseband inputs are differential; equivalent performance is attained by using single-ended drive.

(2) $I, Q = 1\text{ Vp-p}$ implies that the magnitude of the signal at each input pin I_{VIN} , I_{REF} , Q_{VIN} , Q_{REF} is equal to 500 mVp-p.

(3) USB = upper sideband. LSB = lower sideband.

DEFINITIONS OF SELECTED SPECIFICATIONS

Unadjusted Carrier Suppression

This specification measures the amount by which the local oscillator component is attenuated in the output spectrum of the modulator relative to the carrier. It is assumed that the baseband inputs delivered to the pins of the TRF3701 are perfectly matched to have the same dc offset (VCM). This includes all four baseband inputs: IVIN, QVIN, IREF and QREF. Unadjusted carrier suppression is measured in dBc.

Adjusted (Optimized) Carrier Suppression

This differs from the unadjusted suppression number in that the dc offsets of the baseband inputs are iteratively adjusted around their theoretical value of VCM in order to yield the maximum suppression of the LO component in the output spectrum. Adjusted carrier suppression is measured in dBc.

Unadjusted Sideband Suppression

This specification measures the amount by which the unwanted sideband of the input signal is attenuated in the output of the modulator, relative to the wanted sideband. It is assumed that the baseband inputs delivered to the modulator input pins are perfectly matched in amplitude and are exactly 90° out of phase. Unadjusted sideband suppression is measured in dBc.

Adjusted (Optimized) Sideband Suppression

This differs from the unadjusted sideband suppression in that the baseband inputs are iteratively adjusted around their theoretical values to maximize the amount of sideband suppression. Adjusted sideband suppression is measured in dBc.

Suppressions Over Temperature

This specification assumes that the user has gone through the optimization process for the suppression in question, and set the optimal settings for the I, Q inputs at room temperature. This specification then measures the suppression when temperature conditions change after the initial calibration is done.

TYPICAL CHARACTERISTICS

For all the performance plots in this section, the following conditions were used, unless otherwise noted: $T_A = -40^\circ\text{C}$ to 85°C , $V_{CC} = 5\text{ V}$, $V_{CM} = 3.7\text{ V}$, $f_{LO} = 942.5\text{ MHz}$ at $P_{LO} = 0\text{ dBm}$, I and Q inputs driven differentially at a frequency of 50 kHz for an output power level $P_{out} = 0\text{ dBm}$. In the case of optimized suppressions, the point of optimization is noted and is always at nominal conditions and room temperature. A level of $>50\text{ dBc}$ is assumed to be optimized.

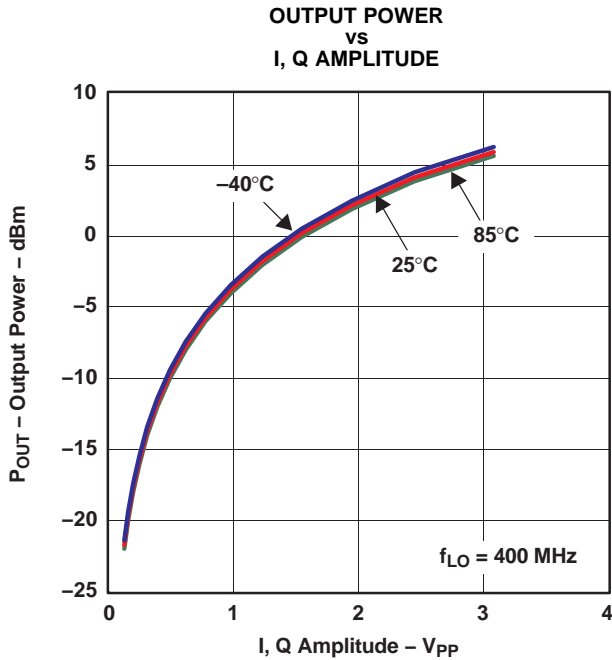

Figure 1.

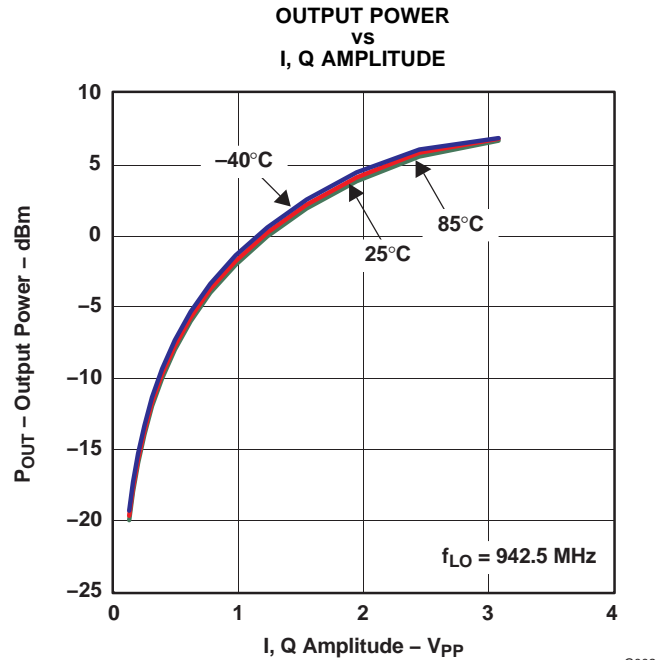

Figure 2.

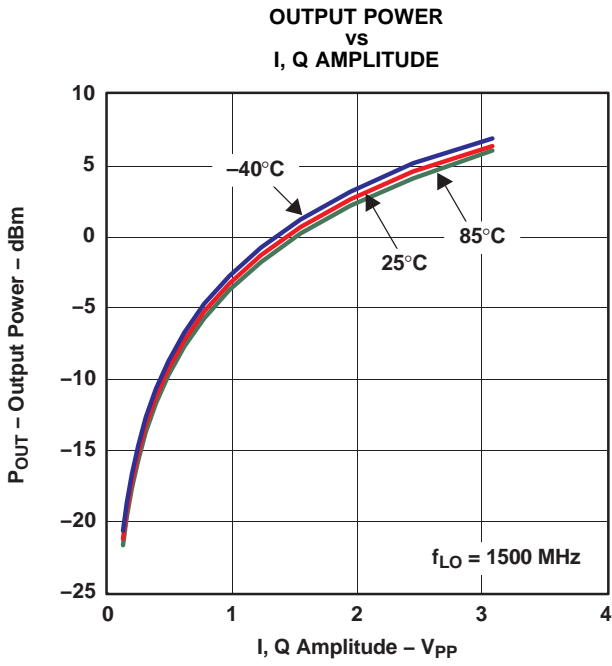

Figure 3.

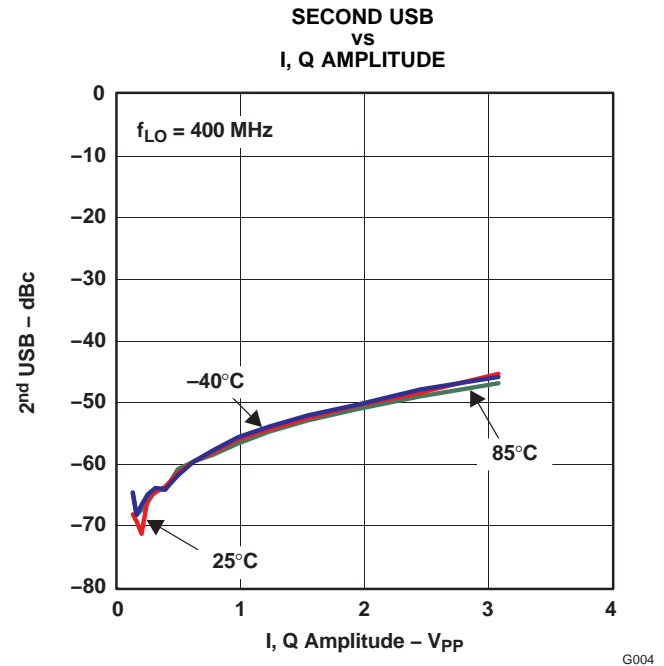

Figure 4.

TYPICAL CHARACTERISTICS (continued)

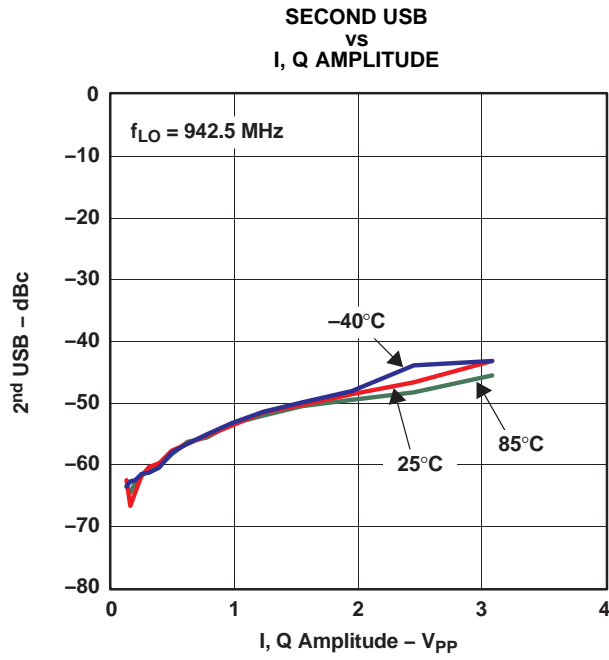

Figure 5.

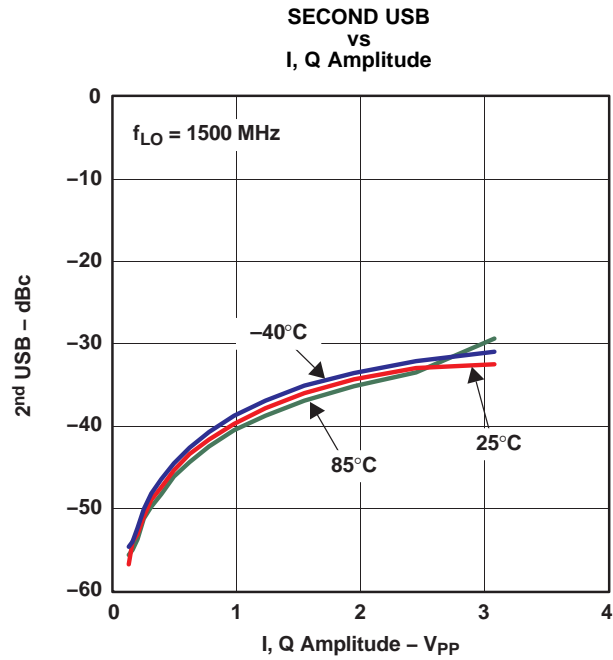

Figure 6.

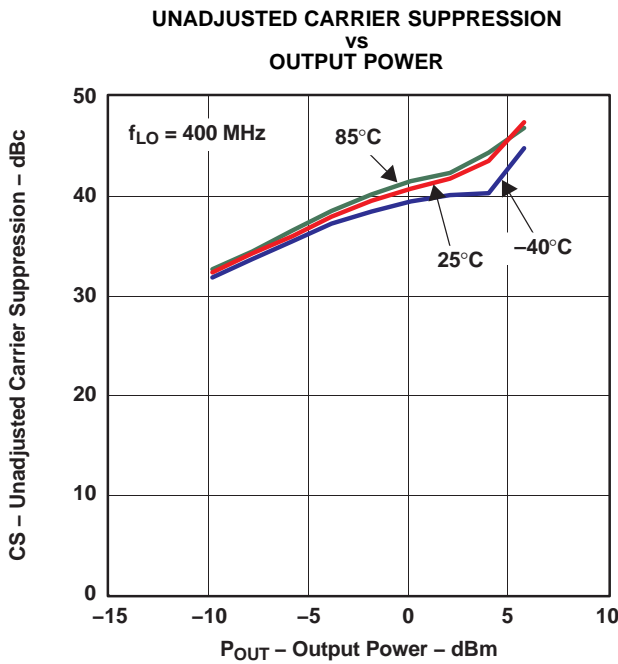

Figure 7.

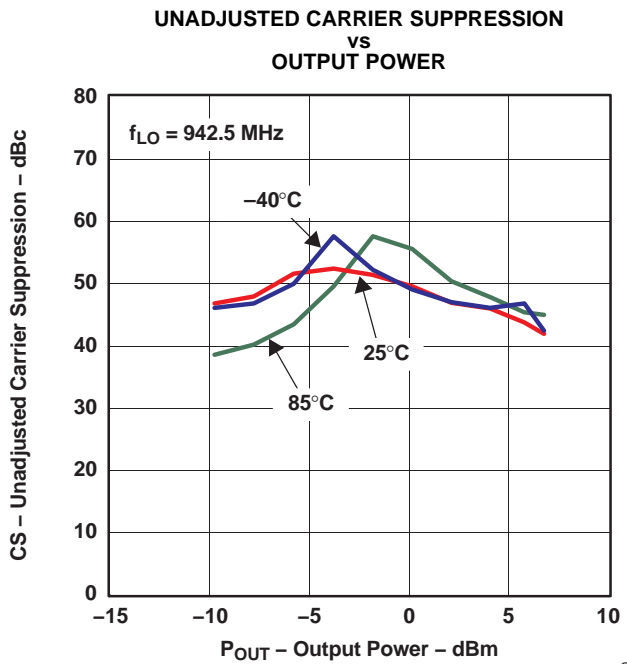

Figure 8.

TYPICAL CHARACTERISTICS (continued)

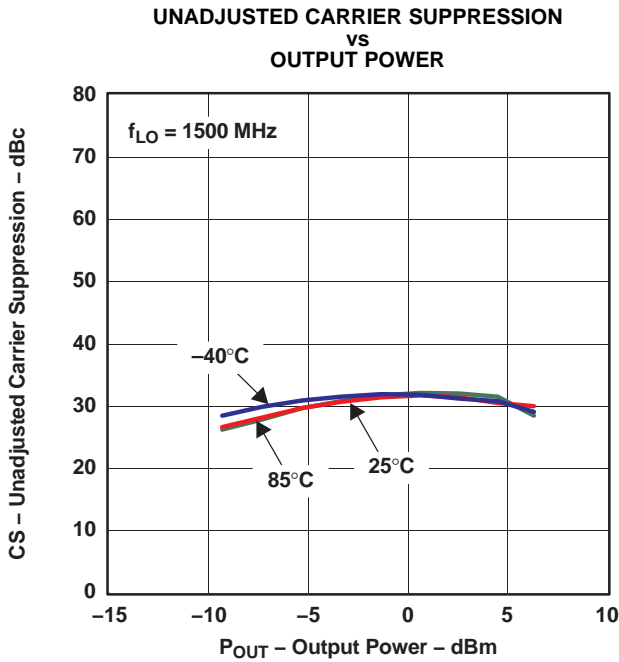

Figure 9.

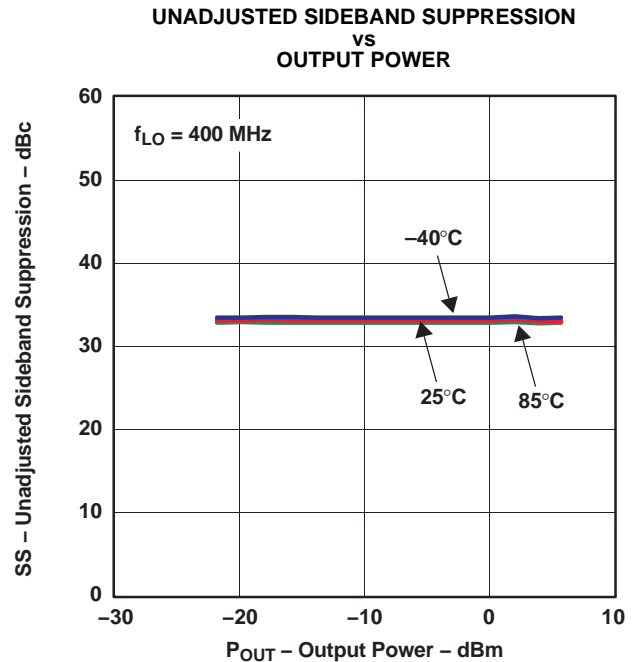

Figure 10.

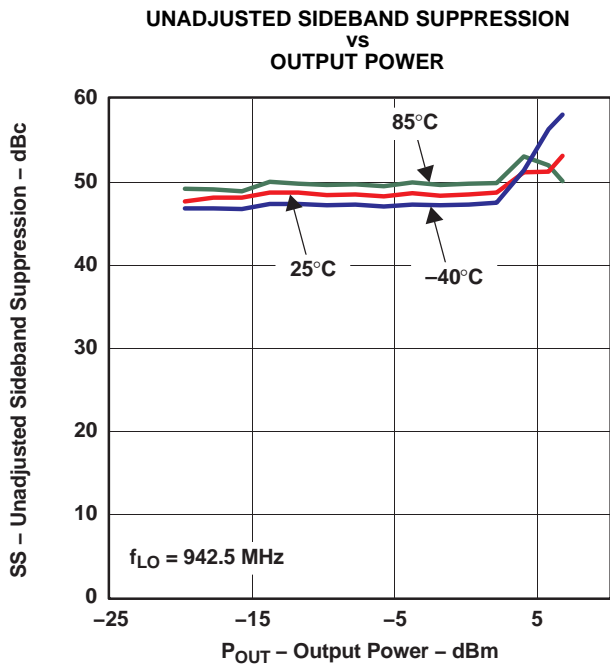

Figure 11.

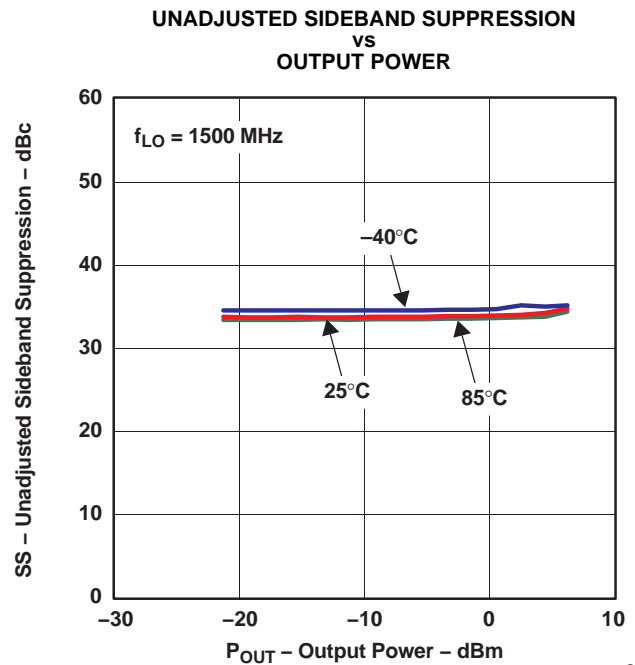
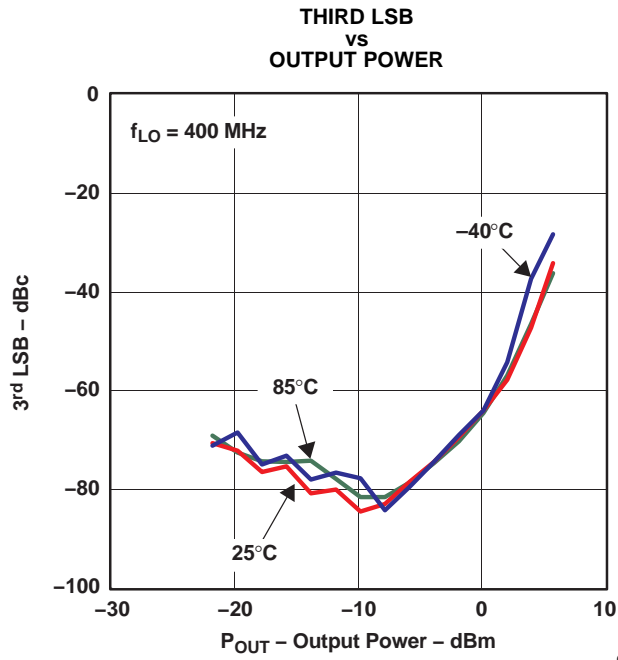

Figure 12.

TYPICAL CHARACTERISTICS (continued)



G013

Figure 13.

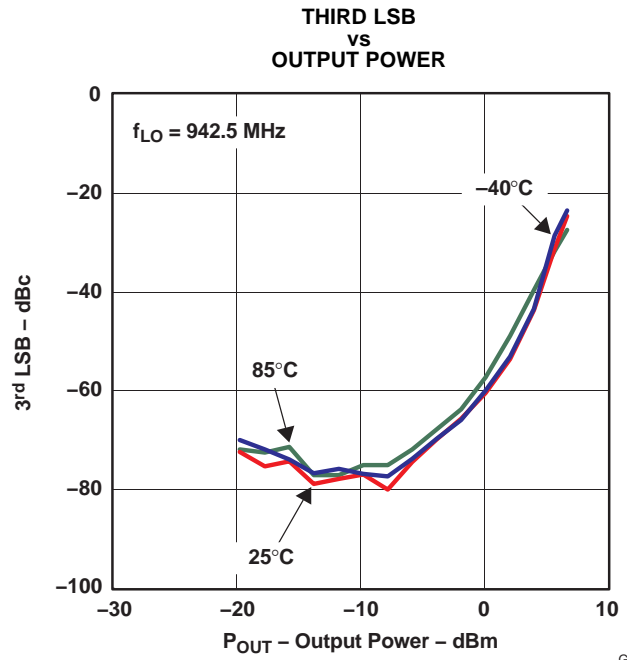

G014

Figure 14.

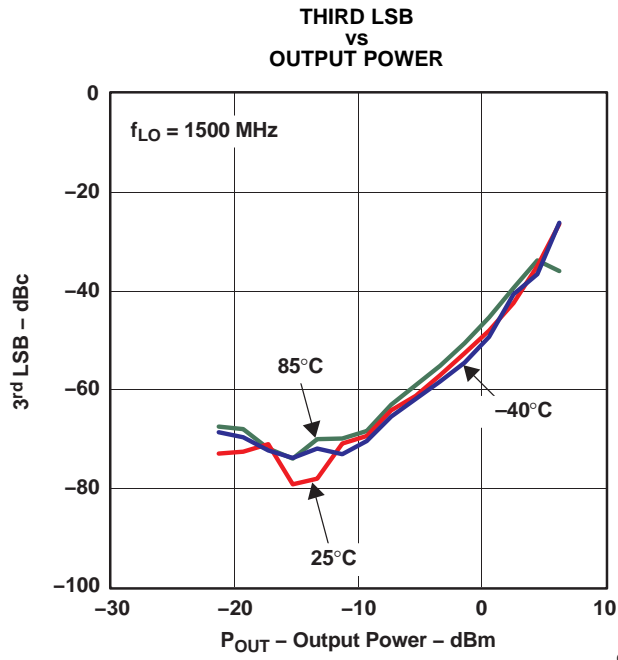

G015

Figure 15.

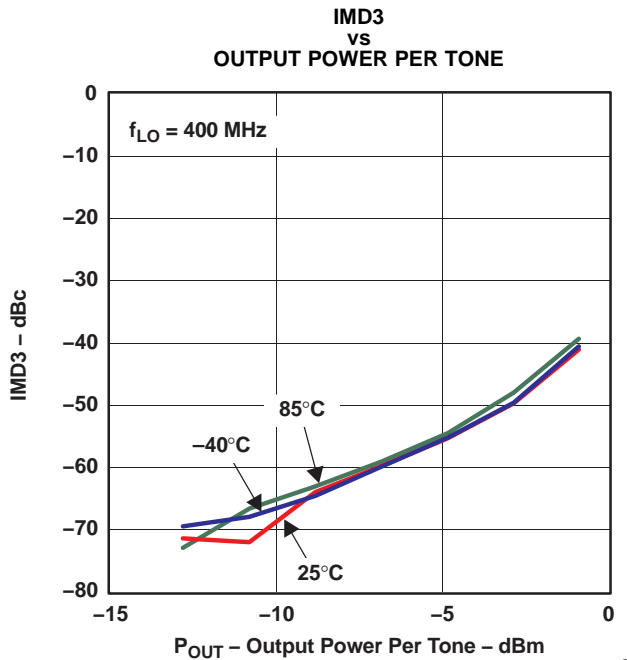

G016

Figure 16.

TYPICAL CHARACTERISTICS (continued)

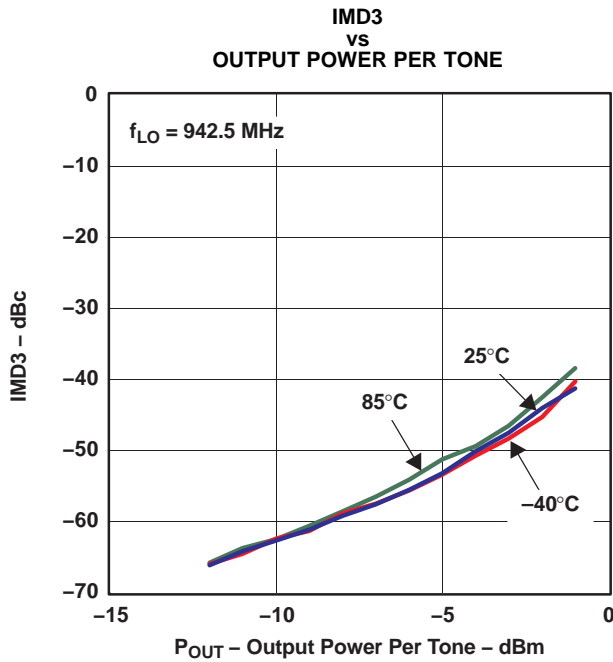

Figure 17.

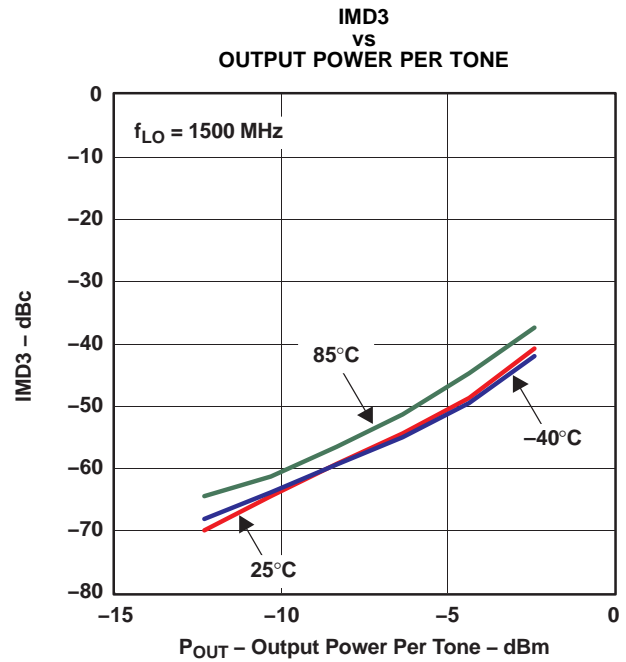

Figure 18.

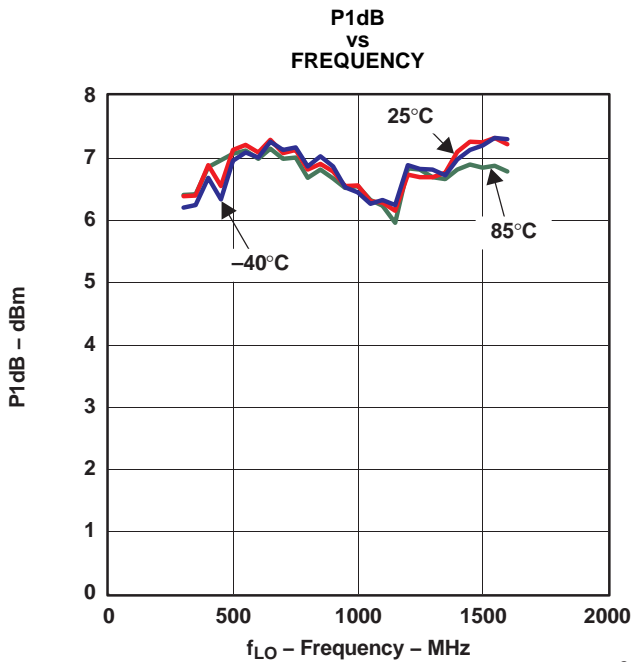

Figure 19.

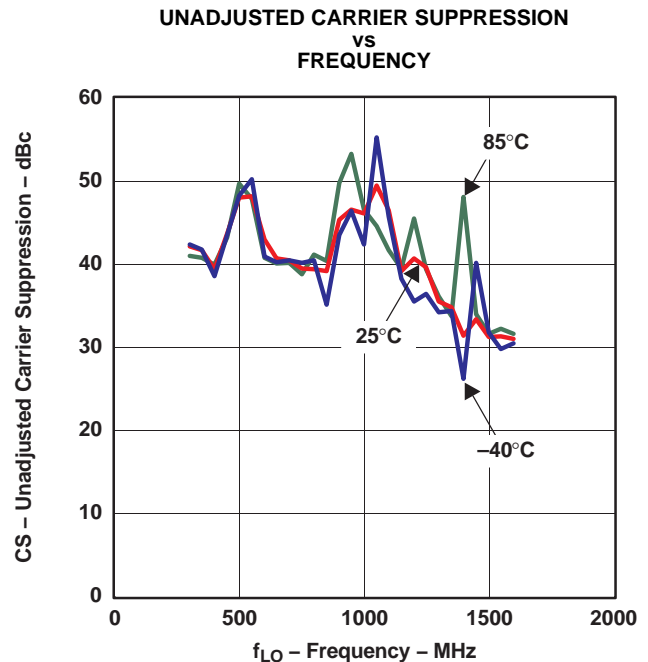

Figure 20.

TYPICAL CHARACTERISTICS (continued)

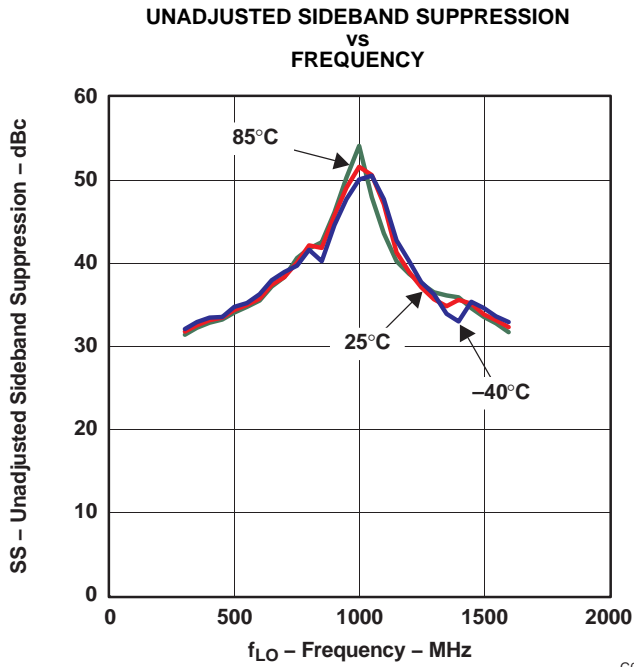

Figure 21.

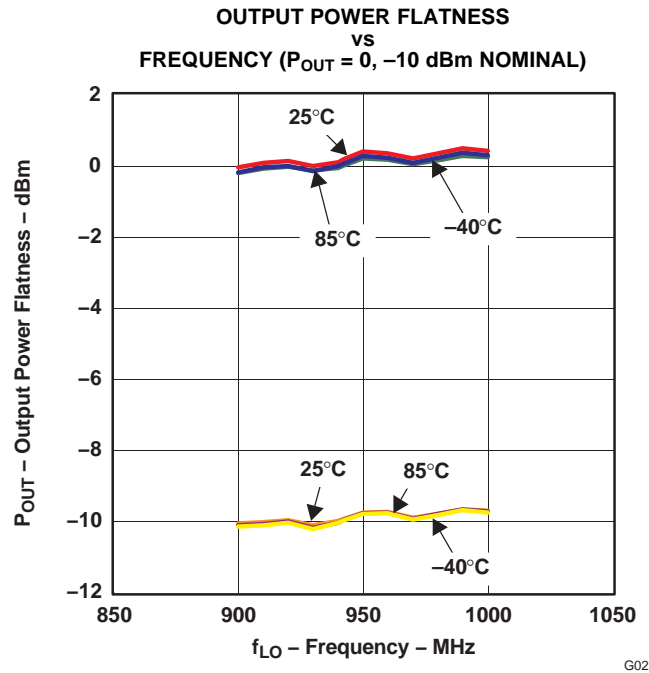

Figure 22.

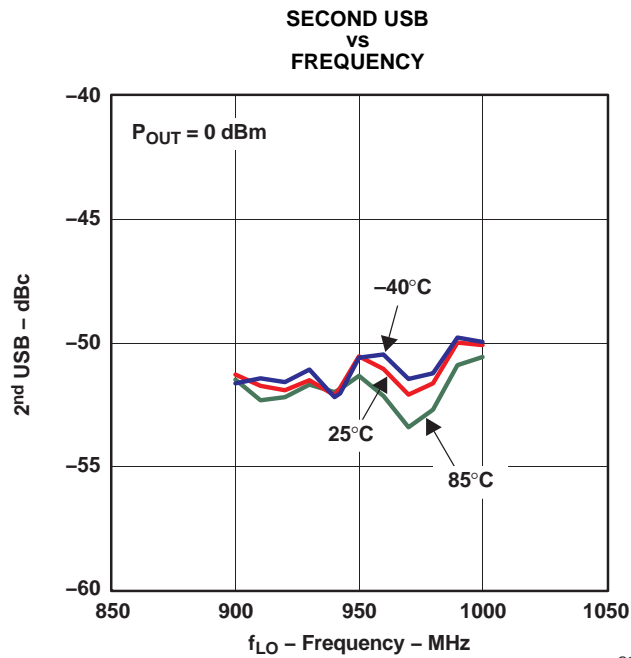

Figure 23.

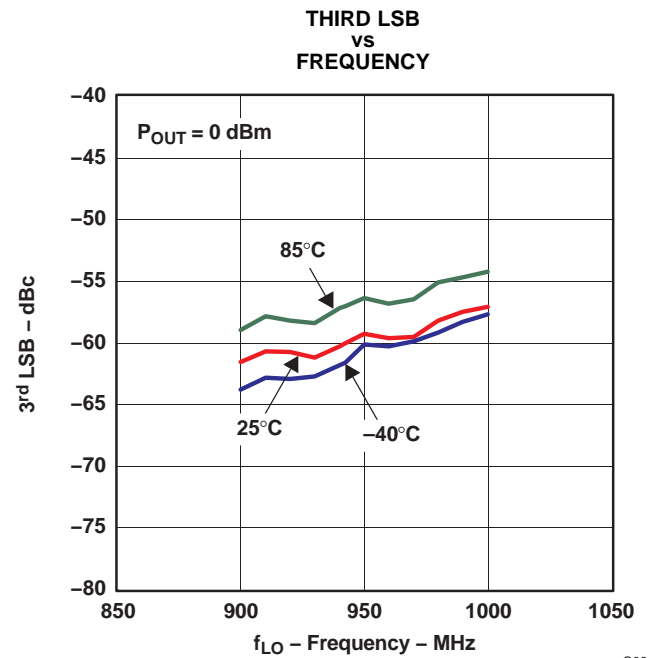

Figure 24.

TYPICAL CHARACTERISTICS (continued)

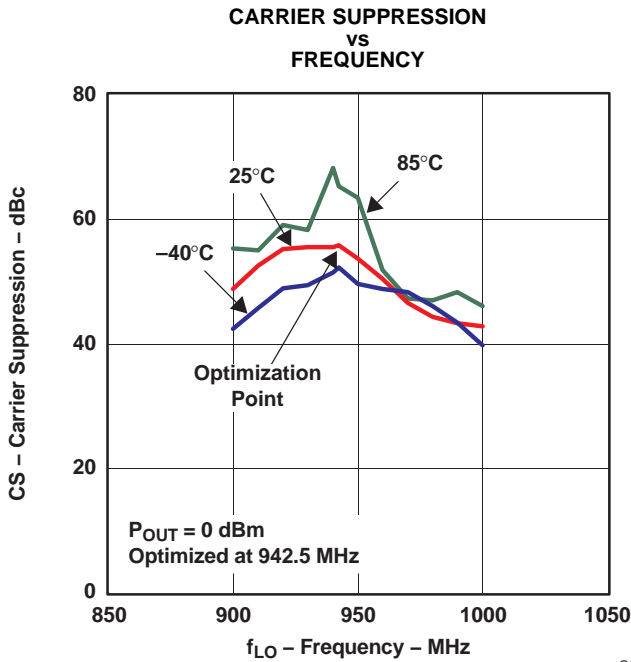

Figure 25.

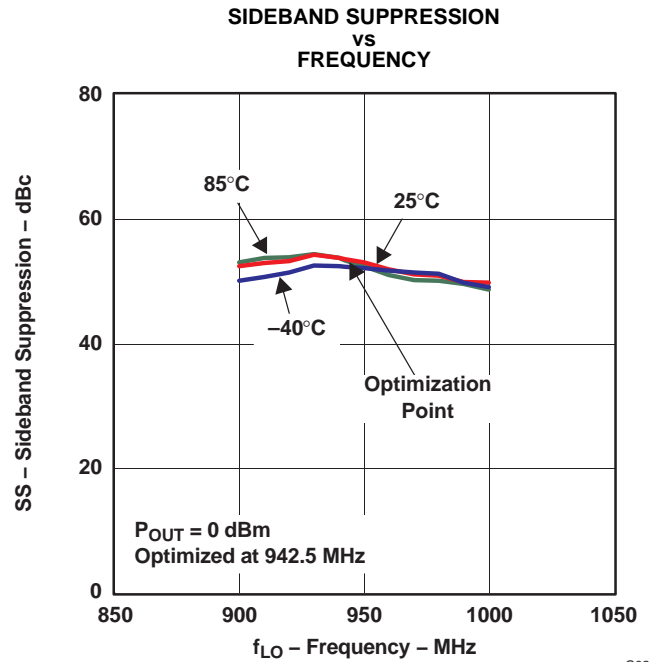

Figure 26.

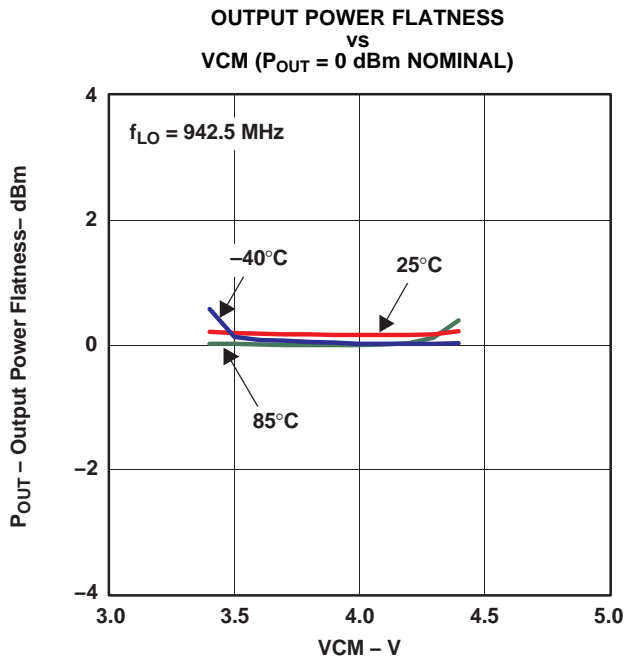

Figure 27.

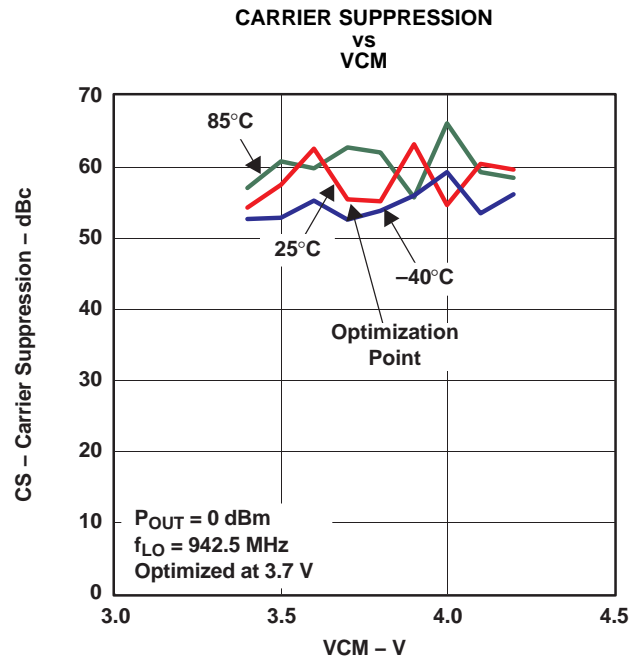

Figure 28.

TYPICAL CHARACTERISTICS (continued)

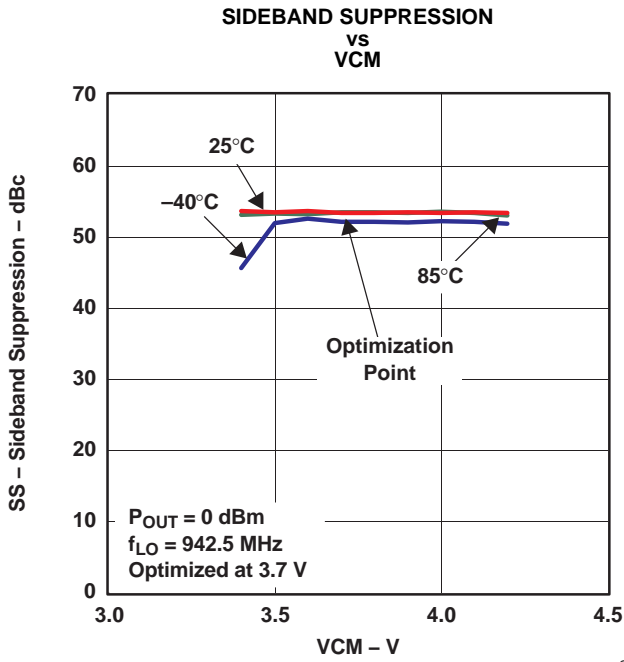

Figure 29.

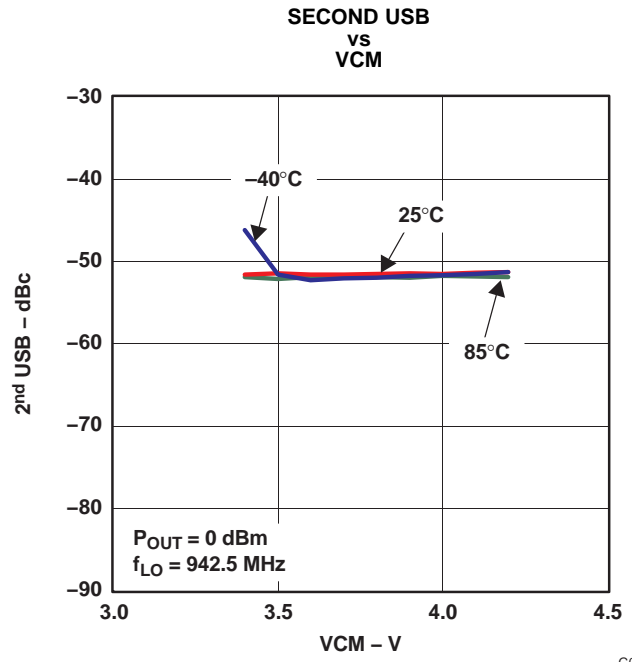

Figure 30.

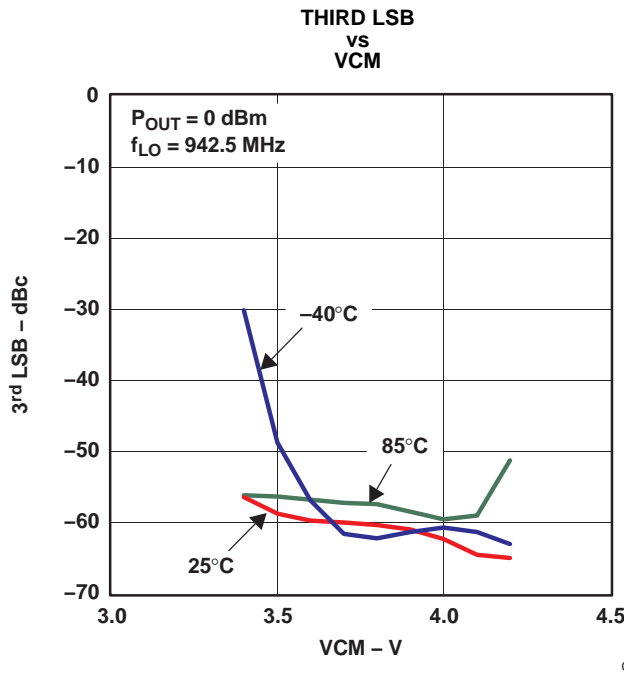

Figure 31.

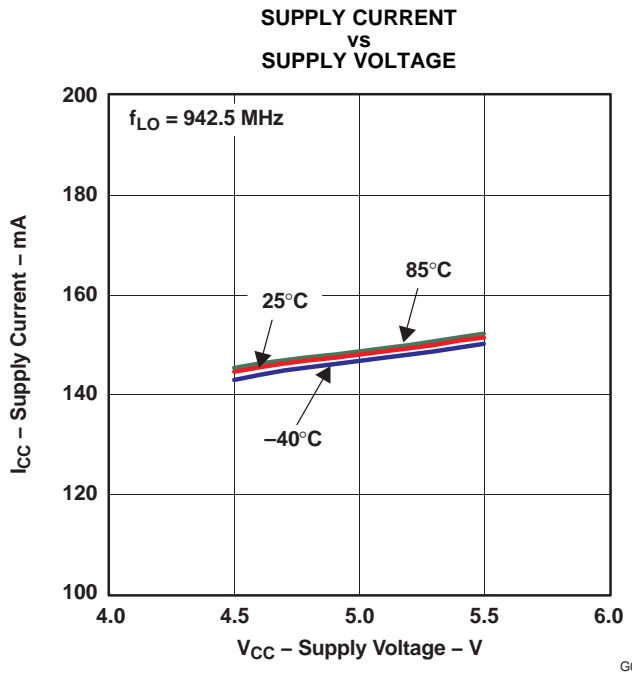

Figure 32.

TYPICAL CHARACTERISTICS (continued)

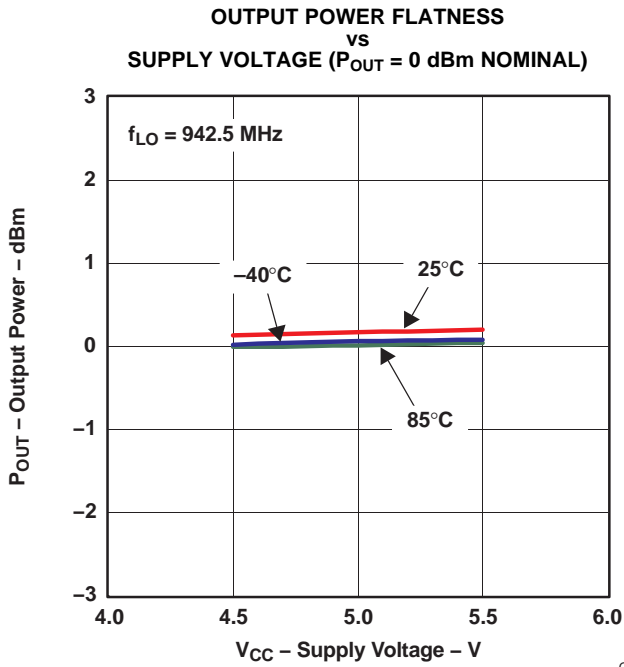

Figure 33.

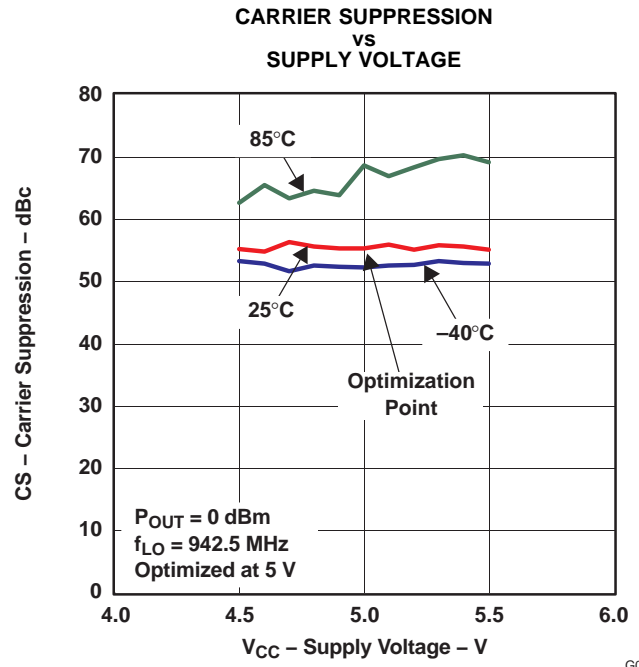

Figure 34.

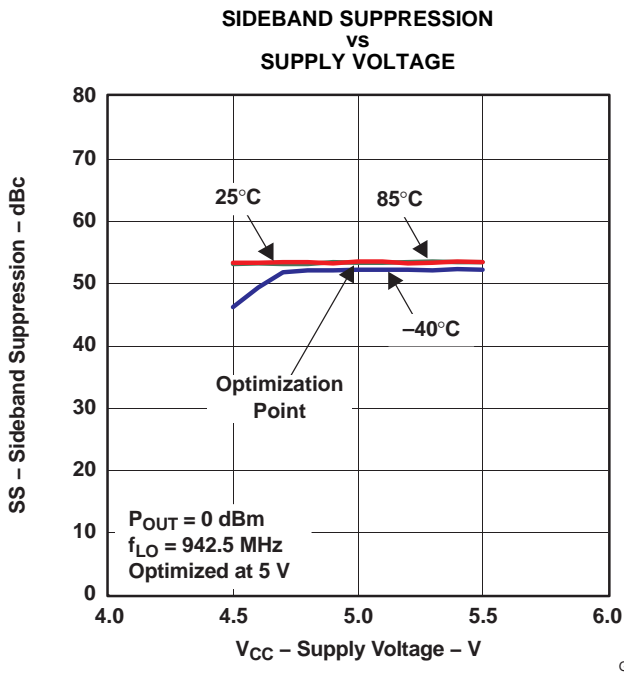

Figure 35.

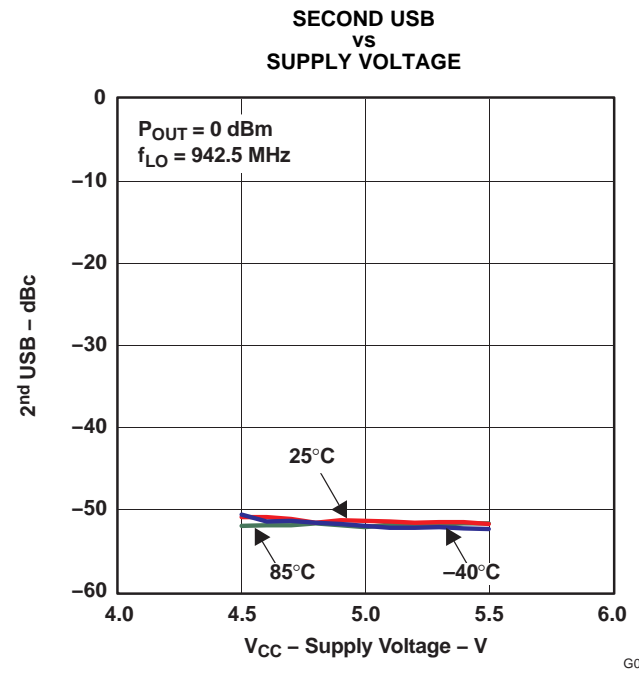

Figure 36.

TYPICAL CHARACTERISTICS (continued)

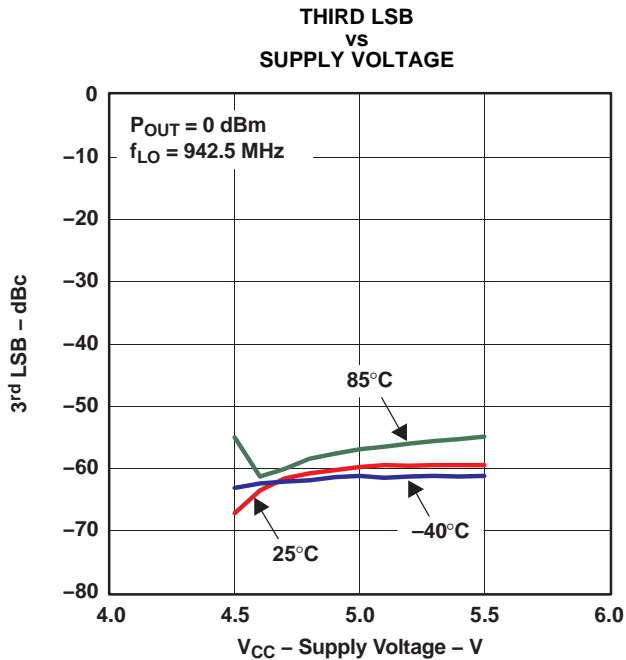

Figure 37.

G037

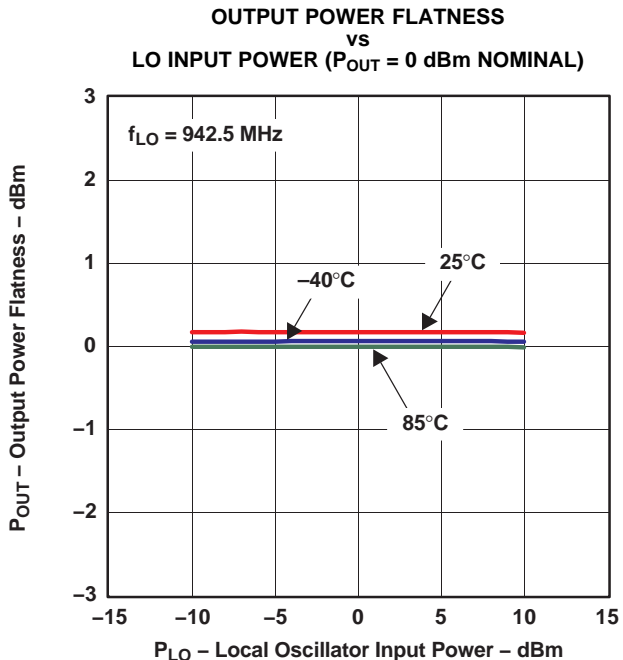

Figure 38.

G038

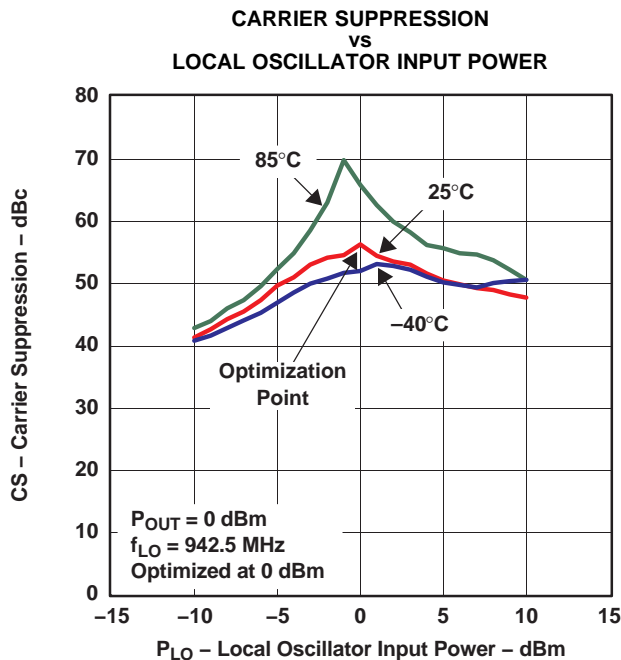

Figure 39.

G039

Table 2. RFOUT and LO Pin Impedance

Frequency (MHz)	Z (RFOUT Pin)	Z (LO Pin)
100	8.59 – j 130.2	33.95 – j 106.93
200	7.12 – j 61.22	29.54 – j 52.57
300	8.52 – j 36.37	28.65 – j 31.83
400	10.5 – j 23.72	29.371 – j 19.33
500	12.82 – j 15.51	30.78 – j 11.42
600	15.26 – j 9.33	32.64 – j 6.06
700	187.1 – j 4.77	34.99 – j 1.65
800	20.8 – j 1.2	36.55 + j 1.65
900	24.2 + j 2.0	38.52 + j 3.98
1000	28.7 + j 4.9	40.29 + j 5.92
1100	32.35 + j 6.61	42.21 + j 6.98
1200	37.15 + j 6.88	44.09 + j 7.55
1300	40.55 + j 6.64	45.7 + j 7.96
1400	43.76 + j 6.4	47 + j 7.76
1500	46.6 + j 6.03	48.28 + j 7.39

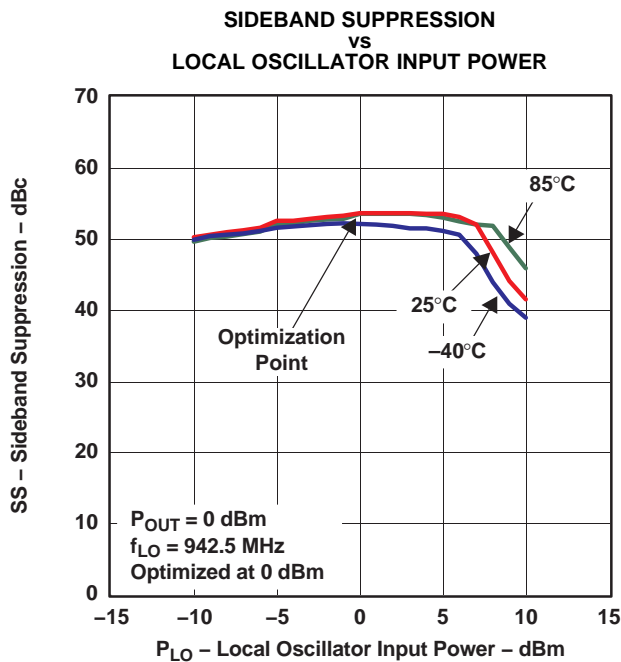

Figure 40.

G040

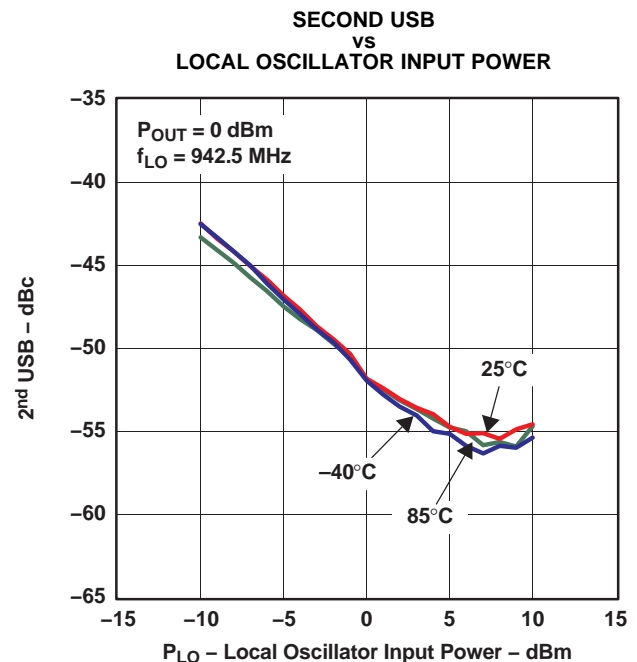
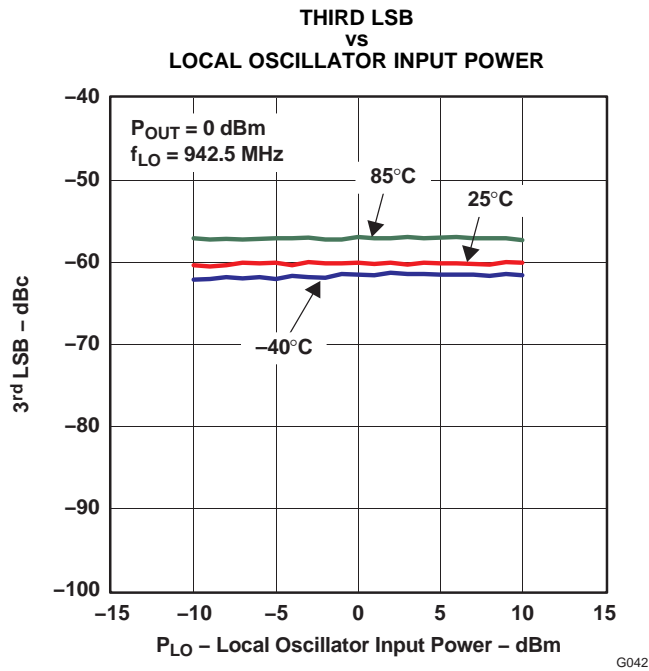

Figure 41.

G041



G042

Figure 42.

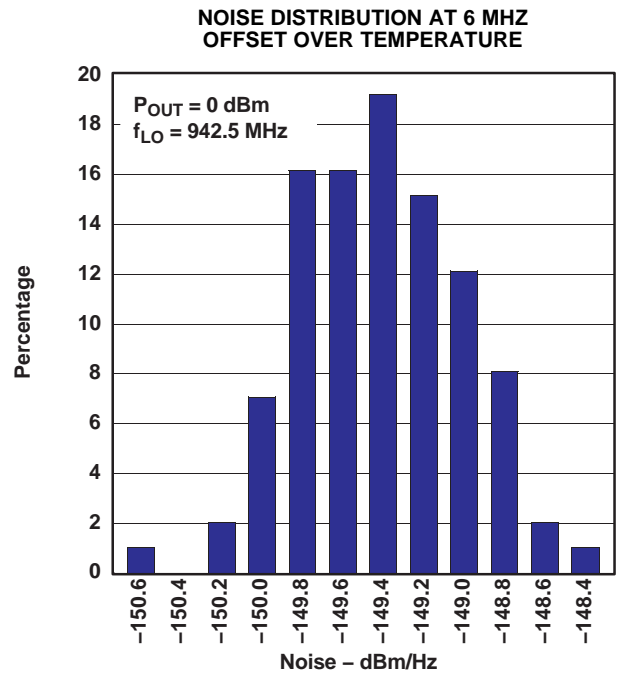

G043

Figure 43.

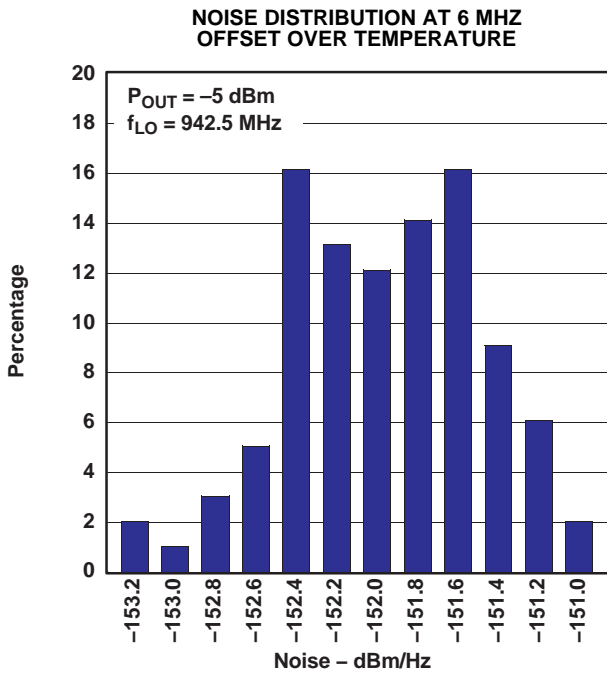

G044

Figure 44.

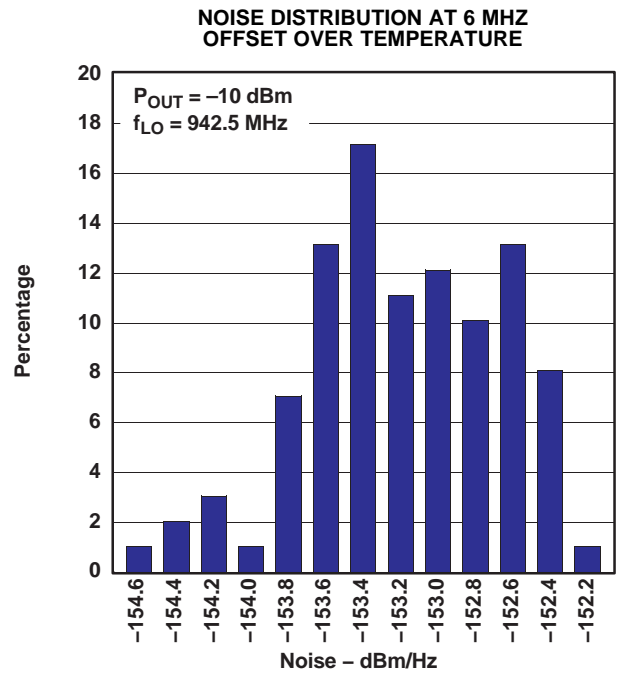

G045

Figure 45.

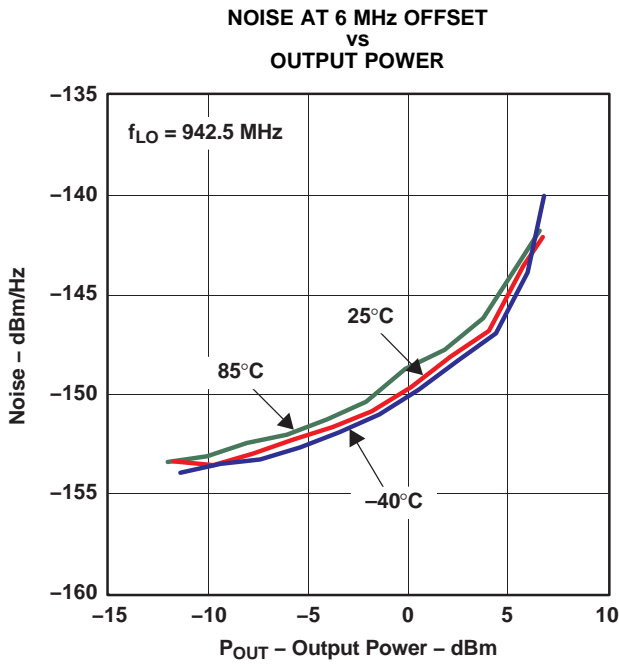

Figure 46.

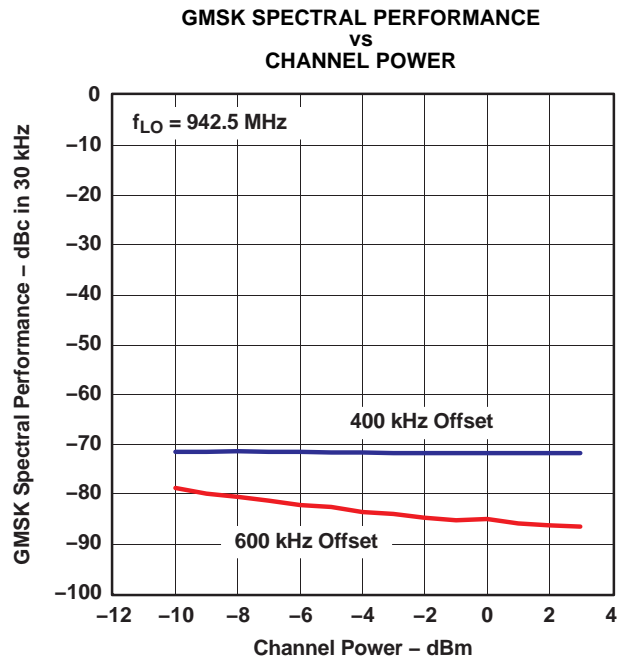

Figure 47.

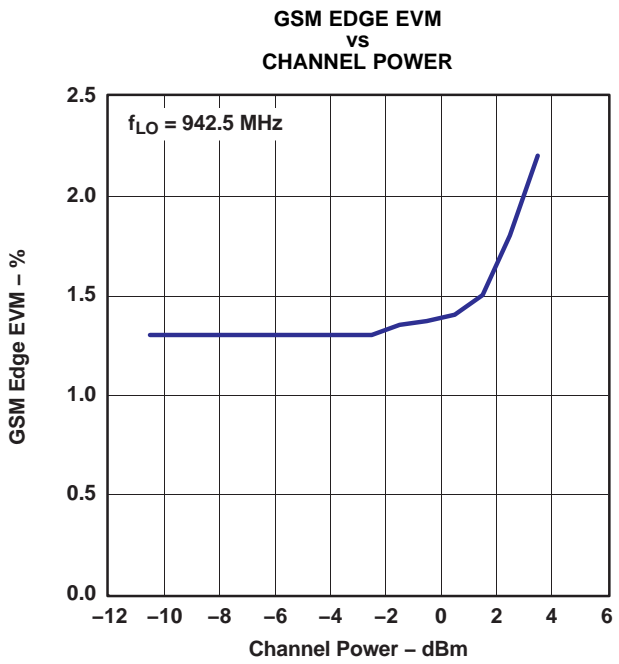

Figure 48.

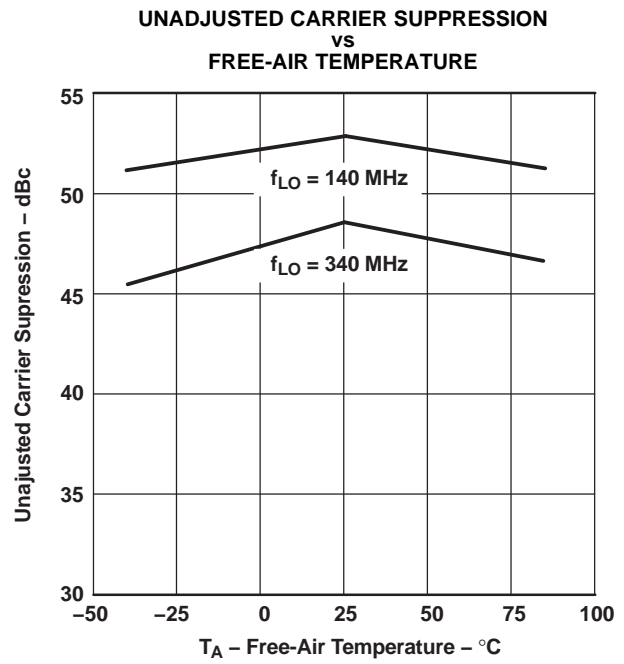

Figure 49.

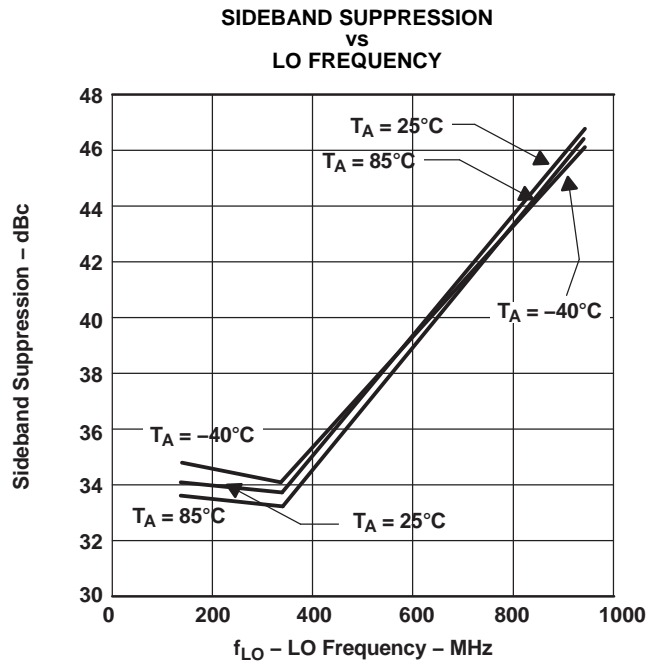

Figure 50.

THEORY OF OPERATION

The TRF3701 employs a double-balanced mixer architecture in implementing the direct I, Q upconversion. The I, Q inputs can be driven single-endedly or differentially, with comparable performance in both cases. The common mode level (VCM) of the four inputs (IVIN, IREF, QVIN, QREF) is typically set to 3.7 V and needs to be driven externally. These inputs go through a set of differential amplifiers and through a V-I converter feed the double-balanced mixers. The AC-coupled LO input to the device goes through a phase splitter to provide the in-phase and quadrature signals that in turn drive the mixers. The outputs of the mixers are then summed, converted to single-ended signals, and amplified before they are fed to the output port RFOUT. The output of the TRF3701 is ac-coupled and can drive 50-Ω loads.

EQUIVALENT CIRCUITS

Figure 51 through Figure 54 show equivalent schematics for the main inputs and outputs of the device.

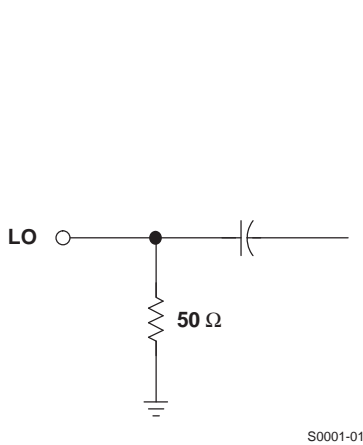

Figure 51. LO Equivalent Input Circuit

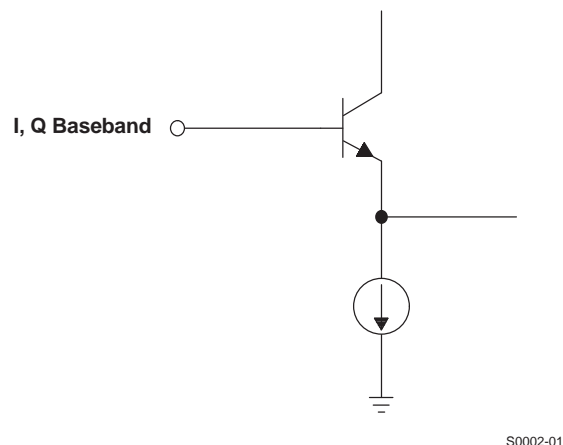
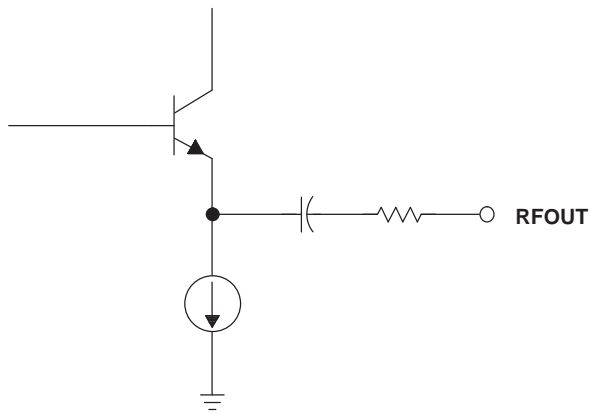
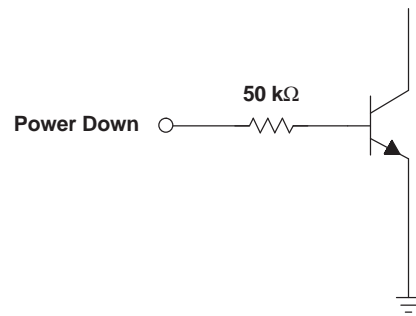

Figure 52. IVIN, QVIN, IREF, QREF Equivalent Circuit



S0003-01

Figure 53. RFOUT Equivalent Circuit



S0004-01

Figure 54. Power-Down (PWD) Equivalent Circuit

APPLICATION INFORMATION

DRIVING THE I, Q INPUTS

There are several ways to drive the four baseband inputs of the TRF3701 to the required amplitude and dc offset. The optimal configuration depends on the end application requirements and the signal levels desired by the designer.

The TRF3701 is by design a differential part, meaning that ideally the user should provide fully complementary signals. However, similar performance in every respect can be achieved if the user only has single-ended signals available. In this case, the IREF and QREF pins just need to have the VCM dc offset applied.

Implementing a Single-to-Differential Conversion for the I, Q inputs

In case differential I, Q signals are desired but not available, the THS4503 family of wideband, low-distortion, fully differential amplifiers can be used to provide a convenient way of performing this conversion. Even if differential signals are available, the THS4503 can provide gain in case a higher voltage swing is required. Besides featuring high bandwidth and high linearity, the THS4503 also provides a convenient way of applying the VCM to all four inputs to the modulator through the VOCM pin (pin 2). The user can further adjust the dc levels for optimum carrier suppression by injecting extra dc at the inputs to the operational amplifier, or by individually adding it to the four outputs. [Figure 55](#) shows a typical implementation of the THS4503 as a driver for the TRF3701. Gain can be easily incorporated in the loop by adjusting the feedback resistors appropriately. For more details, see the THS4503 data sheet at www.ti.com.

APPLICATION INFORMATION (continued)

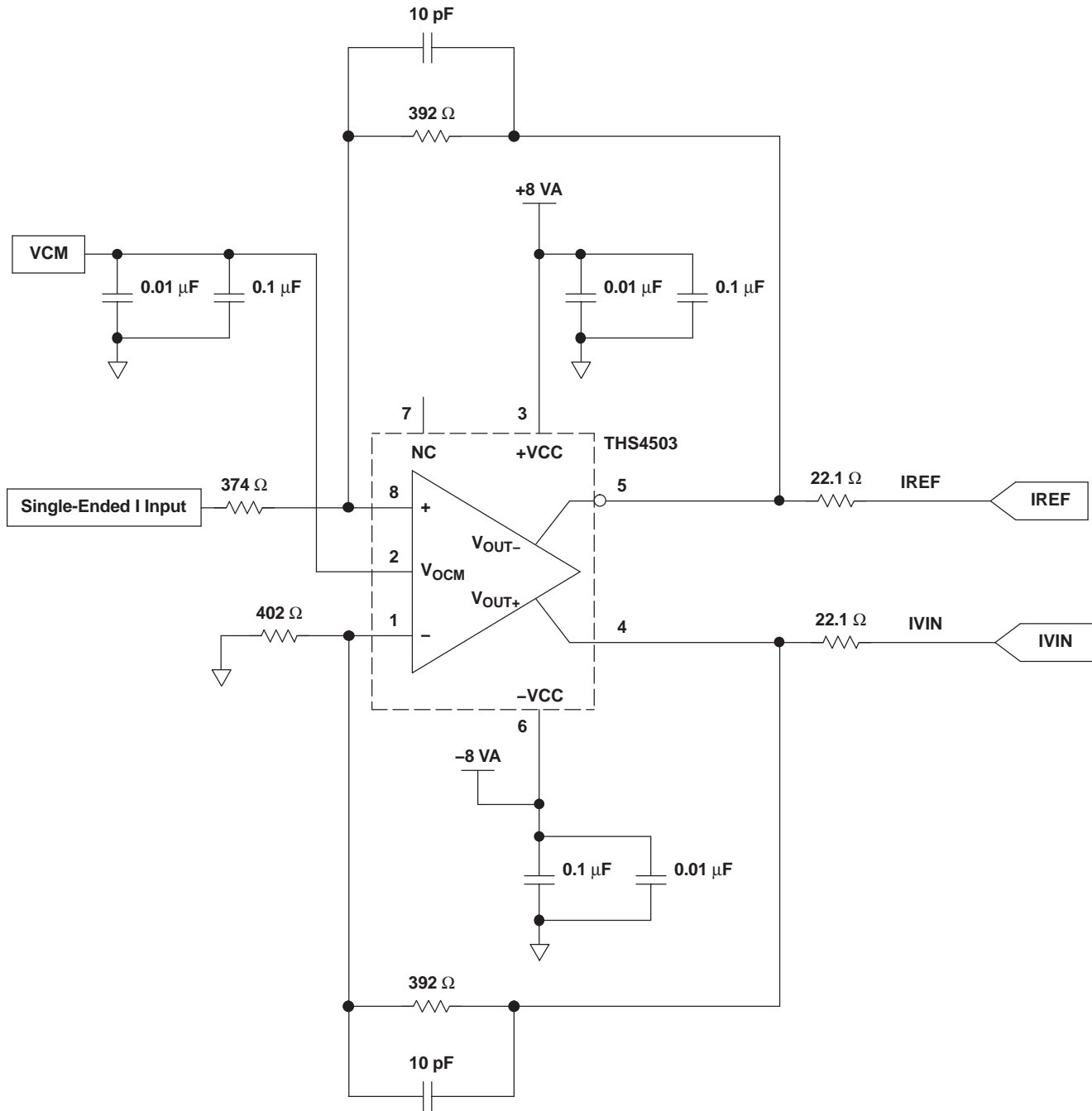

S0005-02

Figure 55. Using the THS4503 to Condition the Baseband Inputs to the TRF3701 (I Channel Shown)

DRIVING THE LOCAL OSCILLATOR INPUT

The LO pin is internally terminated to 50 Ω, thus enabling easy interface to the LO source without the need for external impedance matching. The power level of the LO signal should be in the range of -6 to 6 dBm. For characterization purposes, a power level of 0 dBm was chosen. An ideal way of driving the LO input of the TRF3701 is by using the TRF3750, an ultralow-phase-noise integer-N PLL from Texas Instruments. Combining

APPLICATION INFORMATION (continued)

the TRF3750 with an external VCO can complete the loop and provide a flexible, convenient and cost-effective solution for the local oscillator of the transmitter. Figure 56 shows a typical application for the LO driver network that incorporates the TRF3750 integer-N PLL synthesizer into the design. Depending on the VCO output and the amount of signal loss, an optional gain stage may be added to the output of the VCO before it is applied to the TRF3701 LO input.

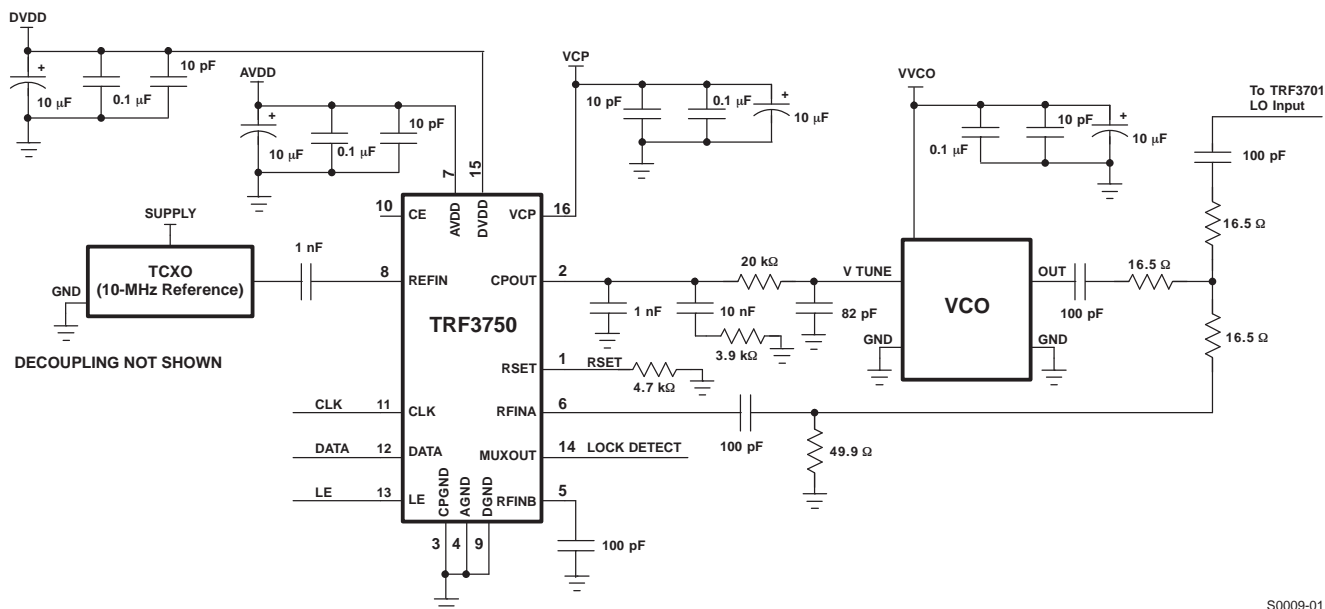

Figure 56. Typical Application Circuit for Generating the LO Signal for the TRF3701 Modulator

PCB LAYOUT CONSIDERATIONS

The TRF3701 is a high-performance RF device; hence, care should be taken in the layout of the PCB in order to ensure optimum performance. Proper decoupling with low ESR capacitors is needed for the VCC supplies (pins 6 and 10). Typical values used are in the order of 1 pF in parallel to 0.1 μF, with the lower-valued capacitors placed closer to the device pins. In addition, a larger tank capacitor in the order of 10 μF should be placed on the supply line as layout permits. At least a 4-layer board is recommended for the PCB. If possible, a solid ground plane and a ground pour is also recommended, as is a power plane for the supplies. Because the balance of the four I, Q inputs to the modulator can be critical to device performance, care should be taken to ensure that the trace runs for all four inputs are equidistant. In the case of single-ended drive of the I, Q inputs, the two unused pins IREF and QREF are fed with the VCM dc voltage only, and should be decoupled with a 0.1-μF capacitor (or smaller). The LO input trace should be minimized in length and have controlled impedance of 50 Ω. No external matching components are needed because there is an internal 50-Ω termination. The RFOUT pin should also have a relatively small trace to minimize parasitics and coupling, and should also be controlled to 50 Ω. An impedance-matching network can be used to optimize power transfer, but is not critical. All the results shown in the data sheet were taken with no impedance matching network used (RFOUT directly driving an external 50-Ω load).

The exposed thermal and ground pad on the bottom of the TRF3701 should be soldered to ground to ensure optimum electrical and thermal performance. The landing pattern on the PCB should include a solid pad and 4 thermal vias. These vias typically have 1,2-mm pitch and 0,3-mm diameter. The vias can be arranged in a 2x2 array. The thermal pad on the PCB should be at least 1.65x1.65 mm.

IMPLEMENTING A DIRECT UPCONVERSION TRANSMITTER USING A TI CommsDAC

The TRF3701 is ideal for implementing a direct upconversion transmitter, where the input I, Q data can originate from an ASIC or a DAC. Texas Instruments' line of digital-to-analog converters (DAC) is ideally suited for interfacing to the TRF3701. Such DACs include, among others, the DAC290x series, DAC5672, and DAC5686.

APPLICATION INFORMATION (continued)

This section illustrates the use of the DAC5686, which offers a unique set of features that make interfacing to the TRF3701 easy and convenient. The DAC5686 is a 16-bit, 500 MSPS, 2x–16x interpolating dual-channel DAC, and it features I, Q adjustments for optimal interface to the TRF3701. User-selectable, 11-bit offset and 12-bit gain adjustments can optimize the carrier and sideband suppression of the modulator, resulting in enhanced performance and relaxed filtering requirements at RF. The preferred mode of operation of the DAC5686 for direct interface with the TRF3701 at baseband is the dual-DAC mode. The user also has the flexibility of selecting any one of the four possible complex spectral bands to be fed into the TRF3701. For details on the available modes and programming, see the DAC5686 data sheet available at www.ti.com.

Figure 57 shows the DAC5686 in dual-DAC mode, which is best-suited for zero-IF interface to the TRF3701. In this mode, a seamless, passive interface between the DAC output and the input to the modulator is used, so that no extra components are needed between the two devices. The optimum dc offset level for the inputs to the TRF3701 (VCM) is approximately 3.7 V. The output of the DAC should be centered around 3.3 V or less (depending on signal swing), in order to ensure that its output compliance limits are not exceeded. The resistive network shown in Figure 57 allows for this dc offset transition while still providing a dc path between the DAC output and the modulator. This ensures that the dc offset adjustments on the DAC5686 can still be applied to optimize the carrier suppression at the modulator output. The combination of the DAC5686 and the TRF3701 provides a unique signal-chain solution with state-of-the-art performance for wireless infrastructure applications.

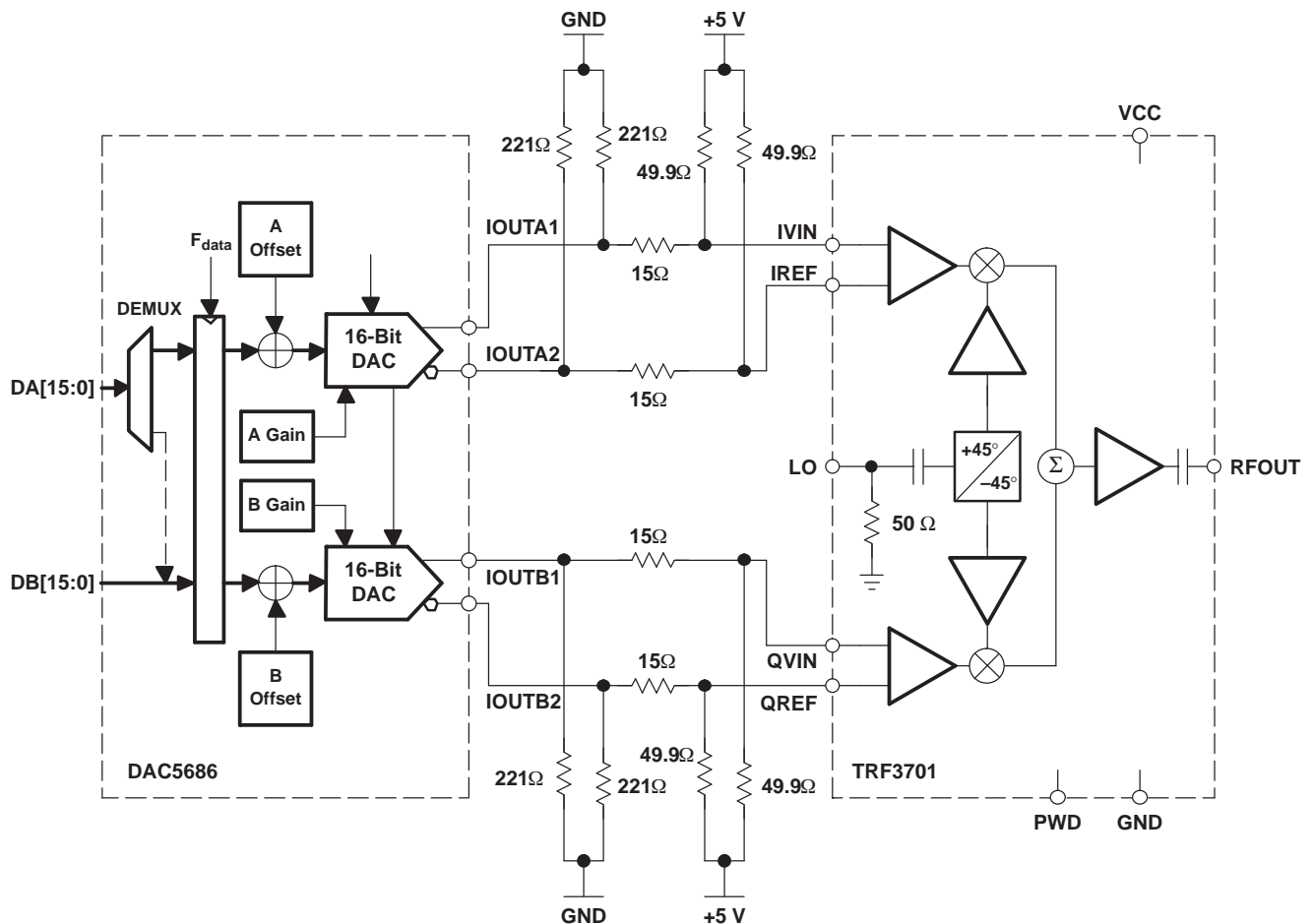

S0010-01

Figure 57. DAC5686 in Dual-DAC Mode with Quadrature Modulator

APPLICATION INFORMATION (continued)

TRF3701 Power Down (PWD) Pin Operation

The power down pin (PWD) in the TRF3701 powers down the chip when 0V is applied to this pin. The TRF3701 is enabled when 5V is applied to the PWD pin. Figure 58 shows the output power as a function of time when the PWD pin is pulled down from 5V to 0V. Both the I/Q signals and the LO are present during the power down. Figure 59 shows the output power as a function of time when the PWD pin is pulled up from 0V to 5V. In both the power down and power up operation there is a smooth transition with no glitches in output power.

The device will not turn on till a voltage greater than 1.2V is applied at the PWD pin. In addition the device does not turn off till the PWD is pulled below 3.7V. This ensures that the device does not accidentally change state due to glitches on the PWD pin. The turn on time of the device is 120 ns and the turn off time is 20 ns.

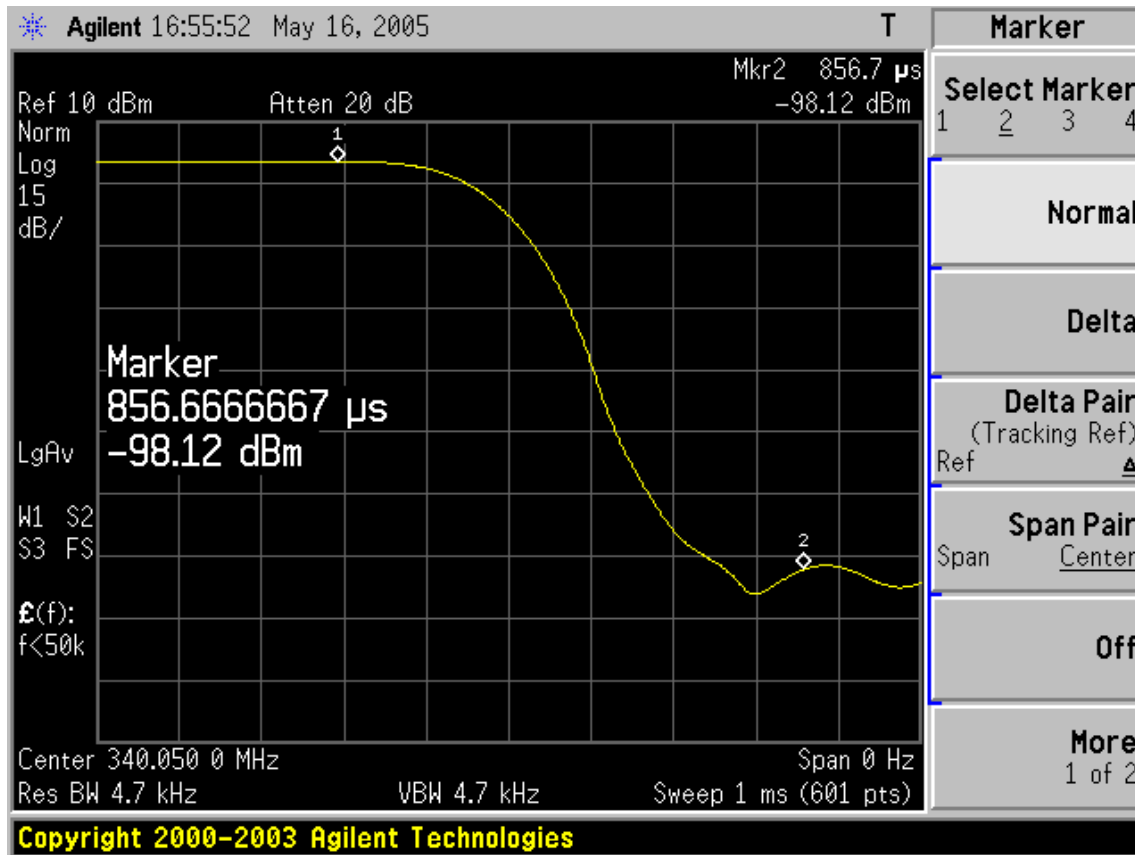

Figure 58. Output power as a Function of Time During a Power-Down Operation (PWD Pin goes from 5V to 0V)

APPLICATION INFORMATION (continued)

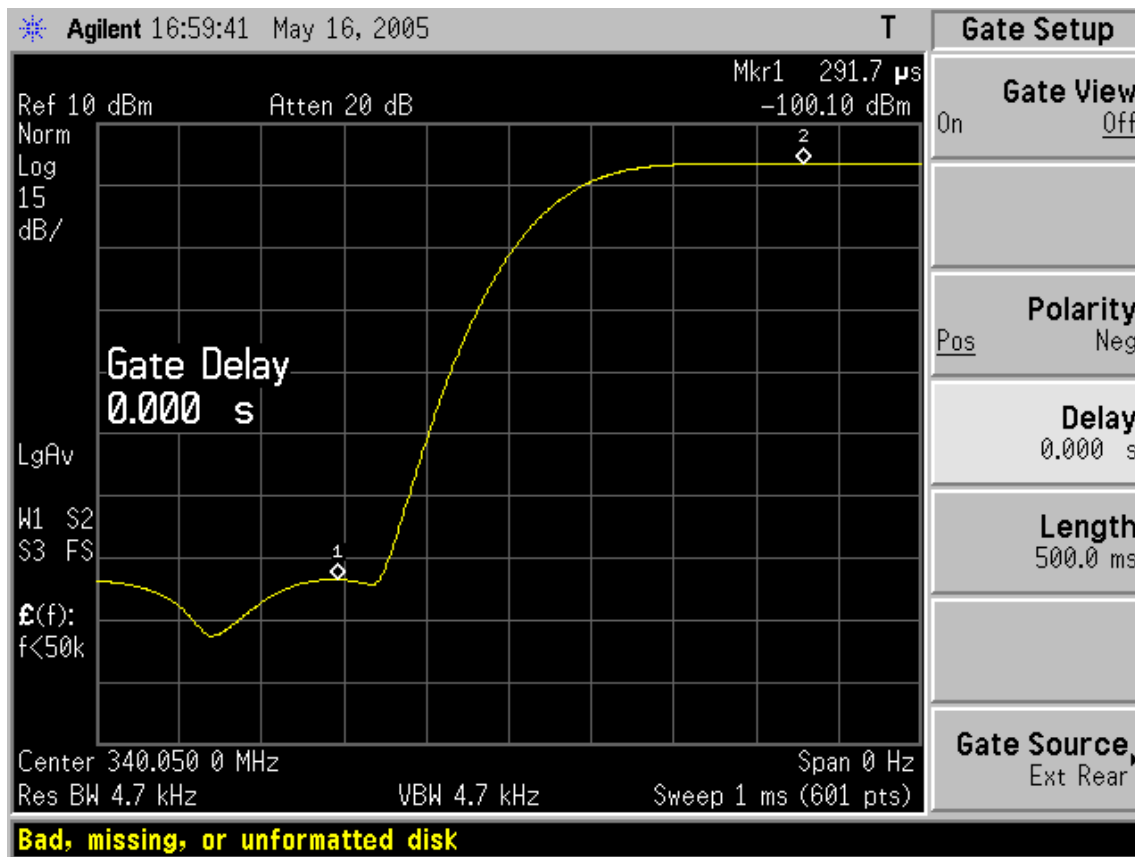

Figure 59. Output Power as a Function of Time During a Power-Up Operation (PWD Pin goes from 0V to 5V)

Optimizing Carrier and Sideband Suppression

For more information on optimizing carrier and sideband suppression, please See *Optimizing Carrier and Sideband Suppression (SLWA046)*.

Revision History

DATE	REV	PAGE	SECTION	DESCRIPTION
29 JUL 05	C	1		Changed data sheet title from "0.4 GHz" to "0.14 GHz"
		2	ESD	Added ESD statement
		3	Recommended Operating Conditions	Changed Input frequency from minimum 400 to minimum 140
				Added PWD operation specifications
		4	RF Output Performance	Added 942.5 MHz to table title
		5	RF Output Performance	Added RF output performance table for 340 MHz and 140 MHz
		19	Typical Characteristics	Added Unadjusted Carrier Suppression vs Free-Air Temperature graph
		20	Typical Characteristics	Added Sideband Suppression vs LO Frequency graph
		26	Application Information	Added TRF3701 Power Down (PWD) Pin Operation section
27	Application Information	Added Optimizing Carrier and Sideband Suppression section		
		28	Thermal Information	Added Thermal Information section
23 JUN 04	B	–	–	Changes unknown
26 MAR 04	A	–	–	Changes unknown
12 FEB 03	*	–	–	Original version

PACKAGING INFORMATION

Orderable Device	Status (1)	Package Type	Package Drawing	Pins	Package Qty	Eco Plan (2)	Lead/Ball Finish (6)	MSL Peak Temp (3)	Op Temp (°C)	Device Marking (4/5)	Samples
TRF3701IRHC	LIFEBUY	VQFN	RHC	16	90	Green (RoHS & no Sb/Br)	CU NIPDAU	Level-2-260C-1 YEAR	-40 to 85	3701 TRF	
TRF3701IRHCR	LIFEBUY	VQFN	RHC	16	3000	Green (RoHS & no Sb/Br)	CU NIPDAU	Level-2-260C-1 YEAR	-40 to 85	3701 TRF	

(1) The marketing status values are defined as follows:

ACTIVE: Product device recommended for new designs.

LIFEBUY: TI has announced that the device will be discontinued, and a lifetime-buy period is in effect.

NRND: Not recommended for new designs. Device is in production to support existing customers, but TI does not recommend using this part in a new design.

PREVIEW: Device has been announced but is not in production. Samples may or may not be available.

OBSOLETE: TI has discontinued the production of the device.

(2) **RoHS:** TI defines "RoHS" to mean semiconductor products that are compliant with the current EU RoHS requirements for all 10 RoHS substances, including the requirement that RoHS substance do not exceed 0.1% by weight in homogeneous materials. Where designed to be soldered at high temperatures, "RoHS" products are suitable for use in specified lead-free processes. TI may reference these types of products as "Pb-Free".

RoHS Exempt: TI defines "RoHS Exempt" to mean products that contain lead but are compliant with EU RoHS pursuant to a specific EU RoHS exemption.

Green: TI defines "Green" to mean the content of Chlorine (Cl) and Bromine (Br) based flame retardants meet JS709B low halogen requirements of <=1000ppm threshold. Antimony trioxide based flame retardants must also meet the <=1000ppm threshold requirement.

(3) MSL, Peak Temp. - The Moisture Sensitivity Level rating according to the JEDEC industry standard classifications, and peak solder temperature.

(4) There may be additional marking, which relates to the logo, the lot trace code information, or the environmental category on the device.

(5) Multiple Device Markings will be inside parentheses. Only one Device Marking contained in parentheses and separated by a "~" will appear on a device. If a line is indented then it is a continuation of the previous line and the two combined represent the entire Device Marking for that device.

(6) Lead/Ball Finish - Orderable Devices may have multiple material finish options. Finish options are separated by a vertical ruled line. Lead/Ball Finish values may wrap to two lines if the finish value exceeds the maximum column width.

Important Information and Disclaimer:The information provided on this page represents TI's knowledge and belief as of the date that it is provided. TI bases its knowledge and belief on information provided by third parties, and makes no representation or warranty as to the accuracy of such information. Efforts are underway to better integrate information from third parties. TI has taken and continues to take reasonable steps to provide representative and accurate information but may not have conducted destructive testing or chemical analysis on incoming materials and chemicals. TI and TI suppliers consider certain information to be proprietary, and thus CAS numbers and other limited information may not be available for release.

In no event shall TI's liability arising out of such information exceed the total purchase price of the TI part(s) at issue in this document sold by TI to Customer on an annual basis.

TAPE AND REEL INFORMATION



QUADRANT ASSIGNMENTS FOR PIN 1 ORIENTATION IN TAPE



*All dimensions are nominal

Device	Package Type	Package Drawing	Pins	SPQ	Reel Diameter (mm)	Reel Width W1 (mm)	A0 (mm)	B0 (mm)	K0 (mm)	P1 (mm)	W (mm)	Pin1 Quadrant
TRF3701IRHCR	VQFN	RHC	16	3000	330.0	12.4	4.3	4.3	1.5	8.0	12.0	Q1

TAPE AND REEL BOX DIMENSIONS



*All dimensions are nominal

Device	Package Type	Package Drawing	Pins	SPQ	Length (mm)	Width (mm)	Height (mm)
TRF3701IRHCR	VQFN	RHC	16	3000	336.6	336.6	28.6

RHC (S-PQFP-N16) (CUSTOM PACKAGE) PLASTIC QUAD FLATPACK

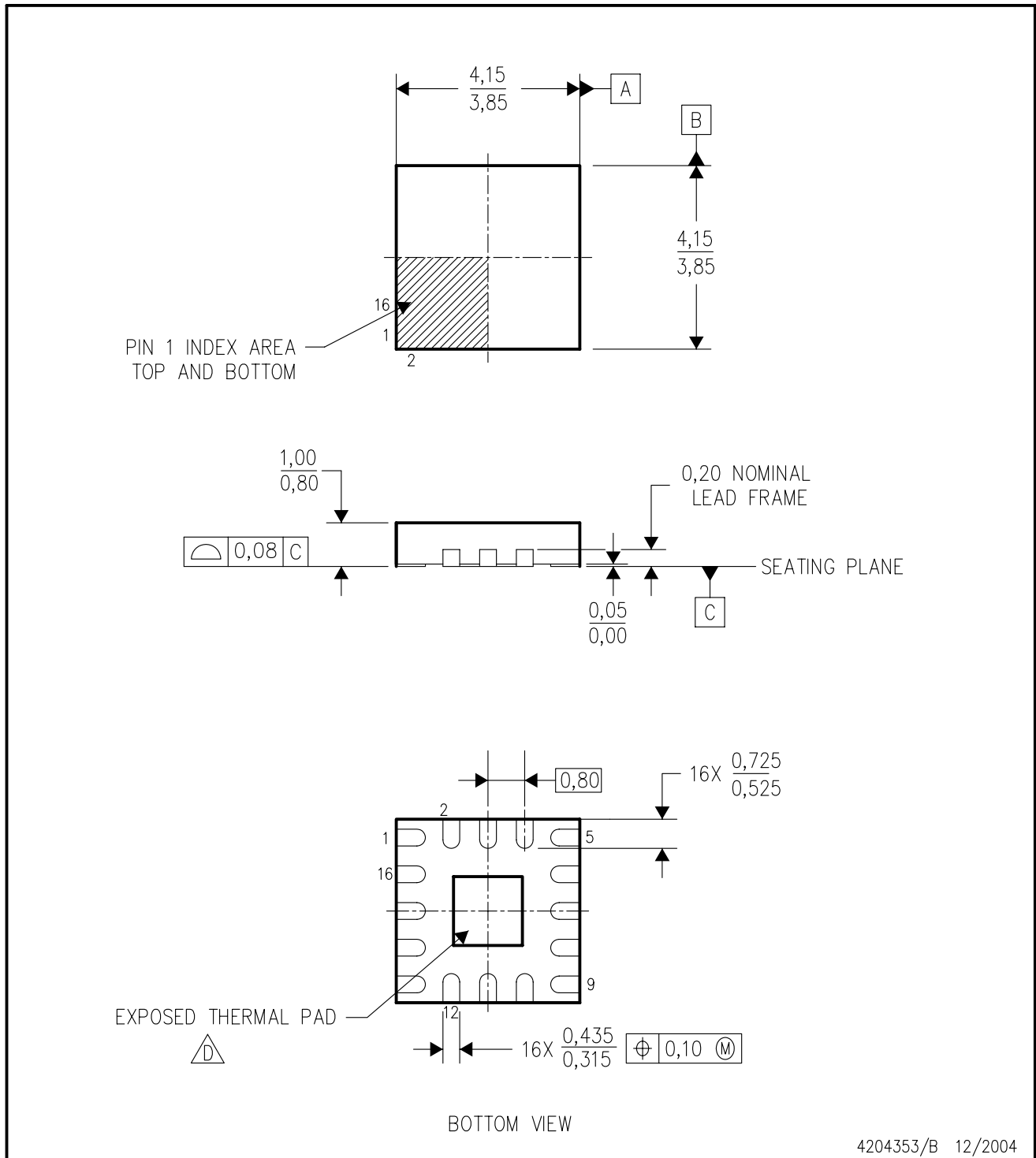

4204353/B 12/2004

- NOTES:
- A. All linear dimensions are in millimeters. Dimensioning and tolerancing per ASME Y14.5M-1994.
 - B. This drawing is subject to change without notice.
 - C. QFN (Quad Flatpack No-Lead) Package configuration.
 -  The package thermal pad must be soldered to the board for thermal and mechanical performance. See the Product Data Sheet for details regarding the exposed thermal pad dimensions.

THERMAL INFORMATION

This package incorporates an exposed thermal pad that is designed to be attached directly to an external heatsink. The thermal pad must be soldered directly to the printed circuit board (PCB). After soldering, the PCB can be used as a heatsink. In addition, through the use of thermal vias, the thermal pad can be attached directly to the appropriate copper plane shown in the electrical schematic for the device, or alternatively, can be attached to a special heatsink structure designed into the PCB. This design optimizes the heat transfer from the integrated circuit (IC).

For information on the Quad Flatpack No-Lead (QFN) package and its advantages, refer to Application Report, Quad Flatpack No-Lead Logic Packages, Texas Instruments Literature No. SCBA017. This document is available at www.ti.com.

The exposed thermal pad dimensions for this package are shown in the following illustration.

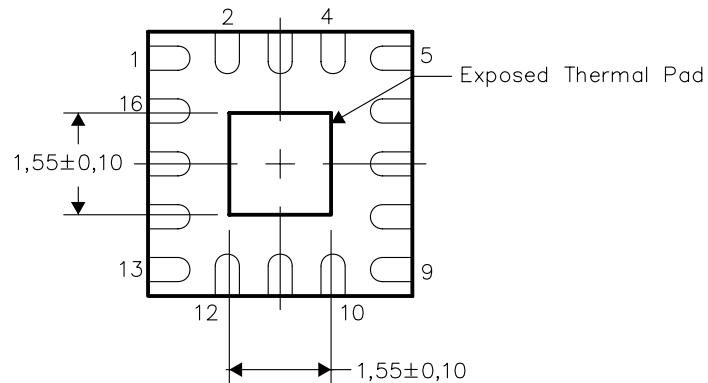

Bottom View

NOTE: All linear dimensions are in millimeters

Exposed Thermal Pad Dimensions

IMPORTANT NOTICE

Texas Instruments Incorporated (TI) reserves the right to make corrections, enhancements, improvements and other changes to its semiconductor products and services per JESD46, latest issue, and to discontinue any product or service per JESD48, latest issue. Buyers should obtain the latest relevant information before placing orders and should verify that such information is current and complete.

TI's published terms of sale for semiconductor products (<http://www.ti.com/sc/docs/stdterms.htm>) apply to the sale of packaged integrated circuit products that TI has qualified and released to market. Additional terms may apply to the use or sale of other types of TI products and services.

Reproduction of significant portions of TI information in TI data sheets is permissible only if reproduction is without alteration and is accompanied by all associated warranties, conditions, limitations, and notices. TI is not responsible or liable for such reproduced documentation. Information of third parties may be subject to additional restrictions. Resale of TI products or services with statements different from or beyond the parameters stated by TI for that product or service voids all express and any implied warranties for the associated TI product or service and is an unfair and deceptive business practice. TI is not responsible or liable for any such statements.

Buyers and others who are developing systems that incorporate TI products (collectively, "Designers") understand and agree that Designers remain responsible for using their independent analysis, evaluation and judgment in designing their applications and that Designers have full and exclusive responsibility to assure the safety of Designers' applications and compliance of their applications (and of all TI products used in or for Designers' applications) with all applicable regulations, laws and other applicable requirements. Designer represents that, with respect to their applications, Designer has all the necessary expertise to create and implement safeguards that (1) anticipate dangerous consequences of failures, (2) monitor failures and their consequences, and (3) lessen the likelihood of failures that might cause harm and take appropriate actions. Designer agrees that prior to using or distributing any applications that include TI products, Designer will thoroughly test such applications and the functionality of such TI products as used in such applications.

TI's provision of technical, application or other design advice, quality characterization, reliability data or other services or information, including, but not limited to, reference designs and materials relating to evaluation modules, (collectively, "TI Resources") are intended to assist designers who are developing applications that incorporate TI products; by downloading, accessing or using TI Resources in any way, Designer (individually or, if Designer is acting on behalf of a company, Designer's company) agrees to use any particular TI Resource solely for this purpose and subject to the terms of this Notice.

TI's provision of TI Resources does not expand or otherwise alter TI's applicable published warranties or warranty disclaimers for TI products, and no additional obligations or liabilities arise from TI providing such TI Resources. TI reserves the right to make corrections, enhancements, improvements and other changes to its TI Resources. TI has not conducted any testing other than that specifically described in the published documentation for a particular TI Resource.

Designer is authorized to use, copy and modify any individual TI Resource only in connection with the development of applications that include the TI product(s) identified in such TI Resource. NO OTHER LICENSE, EXPRESS OR IMPLIED, BY ESTOPPEL OR OTHERWISE TO ANY OTHER TI INTELLECTUAL PROPERTY RIGHT, AND NO LICENSE TO ANY TECHNOLOGY OR INTELLECTUAL PROPERTY RIGHT OF TI OR ANY THIRD PARTY IS GRANTED HEREIN, including but not limited to any patent right, copyright, mask work right, or other intellectual property right relating to any combination, machine, or process in which TI products or services are used. Information regarding or referencing third-party products or services does not constitute a license to use such products or services, or a warranty or endorsement thereof. Use of TI Resources may require a license from a third party under the patents or other intellectual property of the third party, or a license from TI under the patents or other intellectual property of TI.

TI RESOURCES ARE PROVIDED "AS IS" AND WITH ALL FAULTS. TI DISCLAIMS ALL OTHER WARRANTIES OR REPRESENTATIONS, EXPRESS OR IMPLIED, REGARDING RESOURCES OR USE THEREOF, INCLUDING BUT NOT LIMITED TO ACCURACY OR COMPLETENESS, TITLE, ANY EPIDEMIC FAILURE WARRANTY AND ANY IMPLIED WARRANTIES OF MERCHANTABILITY, FITNESS FOR A PARTICULAR PURPOSE, AND NON-INFRINGEMENT OF ANY THIRD PARTY INTELLECTUAL PROPERTY RIGHTS. TI SHALL NOT BE LIABLE FOR AND SHALL NOT DEFEND OR INDEMNIFY DESIGNER AGAINST ANY CLAIM, INCLUDING BUT NOT LIMITED TO ANY INFRINGEMENT CLAIM THAT RELATES TO OR IS BASED ON ANY COMBINATION OF PRODUCTS EVEN IF DESCRIBED IN TI RESOURCES OR OTHERWISE. IN NO EVENT SHALL TI BE LIABLE FOR ANY ACTUAL, DIRECT, SPECIAL, COLLATERAL, INDIRECT, PUNITIVE, INCIDENTAL, CONSEQUENTIAL OR EXEMPLARY DAMAGES IN CONNECTION WITH OR ARISING OUT OF TI RESOURCES OR USE THEREOF, AND REGARDLESS OF WHETHER TI HAS BEEN ADVISED OF THE POSSIBILITY OF SUCH DAMAGES.

Unless TI has explicitly designated an individual product as meeting the requirements of a particular industry standard (e.g., ISO/TS 16949 and ISO 26262), TI is not responsible for any failure to meet such industry standard requirements.

Where TI specifically promotes products as facilitating functional safety or as compliant with industry functional safety standards, such products are intended to help enable customers to design and create their own applications that meet applicable functional safety standards and requirements. Using products in an application does not by itself establish any safety features in the application. Designers must ensure compliance with safety-related requirements and standards applicable to their applications. Designer may not use any TI products in life-critical medical equipment unless authorized officers of the parties have executed a special contract specifically governing such use. Life-critical medical equipment is medical equipment where failure of such equipment would cause serious bodily injury or death (e.g., life support, pacemakers, defibrillators, heart pumps, neurostimulators, and implantables). Such equipment includes, without limitation, all medical devices identified by the U.S. Food and Drug Administration as Class III devices and equivalent classifications outside the U.S.

TI may expressly designate certain products as completing a particular qualification (e.g., Q100, Military Grade, or Enhanced Product). Designers agree that it has the necessary expertise to select the product with the appropriate qualification designation for their applications and that proper product selection is at Designers' own risk. Designers are solely responsible for compliance with all legal and regulatory requirements in connection with such selection.

Designer will fully indemnify TI and its representatives against any damages, costs, losses, and/or liabilities arising out of Designer's non-compliance with the terms and provisions of this Notice.