



2.5 V/3.3 V, 2-Bit, Individual Control Level Translator Bus Switch

ADG3243

FEATURES

- 225 ps Propagation Delay through the Switch
- 4.5 Ω Switch Connection between Ports
- Data Rate 1.5 Gbps
- 2.5 V/3.3 V Supply Operation
- Level Translation
 - 3.3 V to 2.5 V
 - 2.5 V to 1.8 V
- Small Signal Bandwidth 710 MHz
- 8-Lead SOT-23 Package

APPLICATIONS

- 3.3 V to 2.5 V Voltage Translation
- 2.5 V to 1.8 V Voltage Translation
- Bus Switching
- Bus Isolation
- Hot Swap
- Hot Plug
- Analog Switch Applications

GENERAL DESCRIPTION

The ADG3243 is a 2.5 V or 3.3 V, 2-bit, 2-port digital switch with individual channel control. It is designed on a low voltage CMOS process, which provides low power dissipation yet gives high switching speed and very low on resistance. This allows the inputs to be connected to the outputs without additional propagation delay or generating additional ground bounce noise.

The switches are enabled by means of the bus enable (\overline{BE}_x) input signal. This digital switch allows a bidirectional signal to be switched when ON. In the OFF condition, signal levels up to the supplies are blocked.

This device is ideal for applications requiring level translation. When operated from a 3.3 V supply, level translation from 3.3 V inputs to 2.5 V outputs is allowed. Similarly, if the device is operated from a 2.5 V supply and 2.5 V inputs are applied, the device will translate the outputs to 1.8 V. This makes the device suited to applications requiring level translation between different supplies, such as converter to DSP/microcontroller interfacing.

FUNCTIONAL BLOCK DIAGRAM

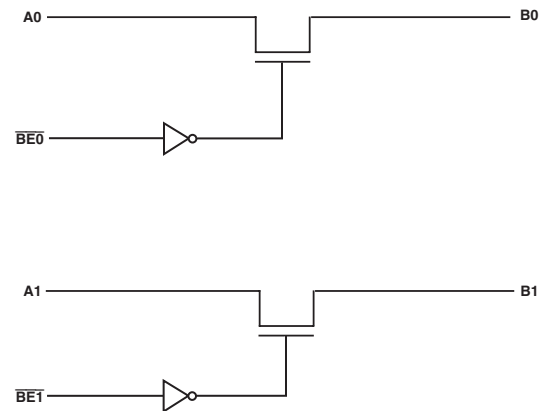

PRODUCT HIGHLIGHTS

1. 3.3 V or 2.5 V supply operation.
2. Extremely low propagation delay through switch.
3. 4.5 Ω switches connect inputs to outputs.
4. Level/voltage translation.
5. Tiny SOT-23 package.

REV. 0

Information furnished by Analog Devices is believed to be accurate and reliable. However, no responsibility is assumed by Analog Devices for its use, nor for any infringements of patents or other rights of third parties that may result from its use. No license is granted by implication or otherwise under any patent or patent rights of Analog Devices. Trademarks and registered trademarks are the property of their respective companies.

One Technology Way, P.O. Box 9106, Norwood, MA 02062-9106, U.S.A.
Tel: 781/329-4700 www.analog.com
Fax: 781/326-8703 © 2003 Analog Devices, Inc. All rights reserved.

ADG3243* Product Page Quick Links

Last Content Update: 11/01/2016

[Comparable Parts](#)

View a parametric search of comparable parts

[Documentation](#)

Data Sheet

- ADG3243: 2.5 V/3.3 V, 2-Bit, Individual Control Level Translator Bus Switch Data Sheet

[Reference Materials](#)

Product Selection Guide

- Switches and Multiplexers Product Selection Guide

Technical Articles

- CMOS Switches Offer High Performance in Low Power, Wideband Applications
- Data-acquisition system uses fault protection
- Enhanced Multiplexing for MEMS Optical Cross Connects

[Design Resources](#)

- ADG3243 Material Declaration
- PCN-PDN Information
- Quality And Reliability
- Symbols and Footprints

[Discussions](#)

View all ADG3243 EngineerZone Discussions

[Sample and Buy](#)

Visit the product page to see pricing options

[Technical Support](#)

Submit a technical question or find your regional support number

ADG3243—SPECIFICATIONS¹ ($V_{CC} = 2.3\text{ V to }3.6\text{ V}$, $GND = 0\text{ V}$, all specifications T_{MIN} to T_{MAX} , unless otherwise noted.)

| Parameter | Symbol | Conditions | B Version | | | Unit |
|---|--------------------|--|-----------|------------------|---------|---------------|
| | | | Min | Typ ² | Max | |
| DC ELECTRICAL CHARACTERISTICS | | | | | | |
| Input High Voltage | V_{INH} | $V_{CC} = 2.7\text{ V to }3.6\text{ V}$ | 2.0 | | | V |
| | V_{INH} | $V_{CC} = 2.3\text{ V to }2.7\text{ V}$ | 1.7 | | | V |
| Input Low Voltage | V_{INL} | $V_{CC} = 2.7\text{ V to }3.6\text{ V}$ | | | 0.8 | V |
| | V_{INL} | $V_{CC} = 2.3\text{ V to }2.7\text{ V}$ | | | 0.7 | V |
| Input Leakage Current | I_I | | | ± 0.01 | ± 1 | μA |
| OFF State Leakage Current | I_{OZ} | $0 \leq A, B \leq V_{CC}$ | | ± 0.01 | ± 1 | μA |
| ON State Leakage Current | | $0 \leq A, B \leq V_{CC}$ | | ± 0.01 | ± 1 | μA |
| Maximum Pass Voltage | V_P | $V_A/V_B = V_{CC} = 3.3\text{ V}$, $I_O = -5\text{ }\mu\text{A}$ | 2.0 | 2.5 | 2.9 | V |
| | | $V_A/V_B = V_{CC} = 2.5\text{ V}$, $I_O = -5\text{ }\mu\text{A}$ | 1.5 | 1.8 | 2.1 | V |
| CAPACITANCE³ | | | | | | |
| A Port Off Capacitance | C_A OFF | $f = 1\text{ MHz}$ | | 3.5 | | pF |
| B Port Off Capacitance | C_B OFF | $f = 1\text{ MHz}$ | | 3.5 | | pF |
| A, B Port On Capacitance | C_A, C_B ON | $f = 1\text{ MHz}$ | | 7 | | pF |
| Control Input Capacitance | C_{IN} | $f = 1\text{ MHz}$ | | 4 | | pF |
| SWITCHING CHARACTERISTICS³ | | | | | | |
| Propagation Delay A to B or B to A, t_{PD} ⁴ | t_{PHL}, t_{PLH} | $C_L = 50\text{ pF}$, $V_{CC} = 3\text{ V}$ | | | 225 | ps |
| Propagation Delay Matching ⁵ | | | | | 5 | ps |
| Bus Enable Time \overline{BEX} to A or B ⁶ | t_{PZH}, t_{PZL} | $V_{CC} = 3.0\text{ V to }3.6\text{ V}$ | 1 | 3.2 | 4.6 | ns |
| Bus Disable Time \overline{BEX} to A or B ⁶ | t_{PHZ}, t_{PLZ} | $V_{CC} = 3.0\text{ V to }3.6\text{ V}$ | 1 | 3 | 4 | ns |
| Bus Enable Time \overline{BEX} to A or B ⁶ | t_{PZH}, t_{PZL} | $V_{CC} = 2.3\text{ V to }2.7\text{ V}$ | 1 | 3 | 4 | ns |
| Bus Disable Time \overline{BEX} to A or B ⁶ | t_{PHZ}, t_{PLZ} | $V_{CC} = 2.3\text{ V to }2.7\text{ V}$ | 1 | 2.5 | 3.4 | ns |
| Maximum Data Rate | | $V_{CC} = 3.3\text{ V}$; $V_A/V_B = 2\text{ V}$ | | 1.5 | | Gbps |
| Channel Jitter | | $V_{CC} = 3.3\text{ V}$; $V_A/V_B = 2\text{ V}$ | | 45 | | ps p-p |
| DIGITAL SWITCH | | | | | | |
| On Resistance | R_{ON} | $V_{CC} = 3\text{ V}$, $V_A = 0\text{ V}$, $I_{BA} = 8\text{ mA}$ | | 4.5 | 8 | Ω |
| | | $V_{CC} = 3\text{ V}$, $V_A = 1.7\text{ V}$, $I_{BA} = 8\text{ mA}$ | | 12 | 28 | Ω |
| | | $V_{CC} = 2.3\text{ V}$, $V_A = 0\text{ V}$, $I_{BA} = 8\text{ mA}$ | | 5 | 9 | Ω |
| | | $V_{CC} = 2.3\text{ V}$, $V_A = 1\text{ V}$, $I_{BA} = 8\text{ mA}$ | | 9 | 18 | Ω |
| On Resistance Matching | ΔR_{ON} | $V_{CC} = 3\text{ V}$, $V_A = 0\text{ V}$, $I_A = 8\text{ mA}$ | | 0.1 | 0.5 | Ω |
| POWER REQUIREMENTS | | | | | | |
| V_{CC} | | | 2.3 | | 3.6 | V |
| Quiescent Power Supply Current | I_{CC} | Digital Inputs = 0 V or V_{CC} | | 0.01 | 1 | μA |
| Increase in I_{CC} per Input ⁷ | ΔI_{CC} | $V_{CC} = 3.6\text{ V}$, $\overline{BE0} = 3.0\text{ V}$, $\overline{BE1} = V_{CC}$ or GND | | 0.15 | 8 | μA |

NOTES

¹Temperature range is as follows: B Version: -40°C to $+85^\circ\text{C}$.

²Typical values are at 25°C , unless otherwise stated.

³Guaranteed by design, not subject to production test.

⁴The digital switch contributes no propagation delay other than the RC delay of the typical R_{ON} of the switch and the load capacitance when driven by an ideal voltage source. Since the time constant is much smaller than the rise/fall times of typical driving signals, it adds very little propagation delay to the system. Propagation delay of the digital switch when used in a system is determined by the driving circuit on the driving side of the switch and its interaction with the load on the driven side.

⁵Propagation delay matching between channels is calculated from the on resistance matching and load capacitance of 50 pF.

⁶See Timing Measurement Information section.

⁷This current applies to the control pin \overline{BEX} only. The A and B ports contribute no significant ac or dc currents as they transition.

Specifications subject to change without notice.

ABSOLUTE MAXIMUM RATINGS*

(T_A = 25°C, unless otherwise noted.)

| | |
|---------------------------------------|-------------------|
| V _{CC} to GND | −0.5 V to +4.6 V |
| Digital Inputs to GND | −0.5 V to +4.6 V |
| DC Input Voltage | −0.5 V to +4.6 V |
| DC Output Current | 25 mA per Channel |
| Operating Temperature Range | |
| Industrial (B Version) | −40°C to +85°C |
| Storage Temperature Range | −65°C to +150°C |
| Junction Temperature | 150°C |
| θ _{JA} Thermal Impedance | 206°C/Ω |
| Lead Temperature, Soldering (10 sec) | 300°C |
| IR Reflow, Peak Temperature (<20 sec) | 235°C |

*Stresses above those listed under Absolute Maximum Ratings may cause permanent damage to the device. This is a stress rating only; functional operation of the device at these or any other conditions above those listed in the operational sections of this specification is not implied. Exposure to absolute maximum rating conditions for extended periods may affect device reliability. Only one absolute maximum rating may be applied at any one time.

PIN CONFIGURATION

8-Lead SOT-23

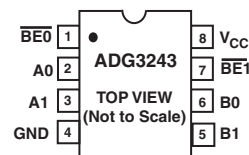

PIN FUNCTION DESCRIPTIONS

| Pin No. | Mnemonic | Description |
|---------|-------------------------|-------------------------------|
| 1 | $\overline{\text{BE0}}$ | Bus Enable (Active Low) |
| 2 | A0 | Port A0, Input or Output |
| 3 | A1 | Port A1, Input or Output |
| 4 | GND | Ground Reference |
| 5 | B1 | Port B1, Input or Output |
| 6 | B0 | Port B0, Input or Output |
| 7 | $\overline{\text{BE1}}$ | Bus Enable (Active Low) |
| 8 | V _{CC} | Positive Power Supply Voltage |

Table I. Truth Table

| $\overline{\text{BE}}_x$ | Function |
|--------------------------|--|
| L | A _x = B _x , 3.3 V to 2.5 V/2.5 V to 1.8 V Level Shifting |
| H | Disconnect |

ORDERING GUIDE

| Model | Temperature Range | Package Description | Package | Branding |
|------------------|-------------------|---|---------|----------|
| ADG3243BRJ-R2 | −40°C to +85°C | SOT-23 (Small Outline Transistor Package) | RJ-8 | SFA |
| ADG3243BRJ-REEL | −40°C to +85°C | SOT-23 (Small Outline Transistor Package) | RJ-8 | SFA |
| ADG3243BRJ-REEL7 | −40°C to +85°C | SOT-23 (Small Outline Transistor Package) | RJ-8 | SFA |

CAUTION

ESD (electrostatic discharge) sensitive device. Electrostatic charges as high as 4000 V readily accumulate on the human body and test equipment and can discharge without detection. Although the ADG3243 features proprietary ESD protection circuitry, permanent damage may occur on devices subjected to high energy electrostatic discharges. Therefore, proper ESD precautions are recommended to avoid performance degradation or loss of functionality.



TERMINOLOGY

| | |
|--------------------|--|
| V_{CC} | Positive Power Supply Voltage. |
| GND | Ground (0 V) Reference. |
| V_{INH} | Minimum Input Voltage for Logic 1. |
| V_{INL} | Maximum Input Voltage for Logic 0. |
| I_I | Input Leakage Current at the Control Inputs. |
| I_{OZ} | OFF State Leakage Current. It is the maximum leakage current at the switch pin in the OFF state. |
| I_{OL} | ON State Leakage Current. It is the maximum leakage current at the switch pin in the ON state. |
| V_P | Maximum Pass Voltage. The maximum pass voltage relates to the clamped output voltage of an NMOS device when the switch input voltage is equal to the supply voltage. |
| R_{ON} | Ohmic Resistance Offered by a Switch in the ON State. It is measured at a given voltage by forcing a specified amount of current through the switch. |
| ΔR_{ON} | ON Resistance Match between Any Two Channels, i.e., $R_{ON\ max} - R_{ON\ min}$. |
| $C_X\ OFF$ | OFF Switch Capacitance. |
| $C_X\ ON$ | ON Switch Capacitance. |
| C_{IN} | Control Input Capacitance. This consists of \overline{BEx} . |
| I_{CC} | Quiescent Power Supply Current. This current represents the leakage current between the V_{CC} and ground pins. It is measured when all control inputs are at a logic high or low level and the switches are OFF. |
| ΔI_{CC} | Extra power supply current component for the \overline{EN} control input when the input is not driven at the supplies. |
| t_{PLH}, t_{PHL} | Data Propagation Delay through the Switch in the ON State. Propagation delay is related to the RC time constant $R_{ON} \times C_L$, where C_L is the load capacitance. |
| t_{PZH}, t_{PZL} | Bus Enable Times. These are the times taken to cross the V_T voltage at the switch output when the switch turns on in response to the control signal, \overline{BEx} . |
| t_{PHZ}, t_{PLZ} | Bus Disable Times. This is the time taken to place the switch in the high impedance OFF state in response to the control signal. It is measured as the time taken for the output voltage to change by V_Δ from the original quiescent level, with reference to the logic level transition at the control input. (Refer to Figure 3 for enable and disable times.) |
| Max Data Rate | Maximum Rate at which Data Can Be Passed through the Switch. |
| Channel Jitter | Peak-to-Peak Value of the Sum of the Deterministic and Random Jitter of the Switch Channel. |

Typical Performance Characteristics—ADG3243

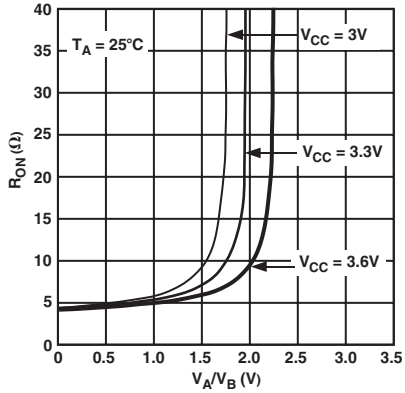

TPC 1. On Resistance vs. Input Voltage

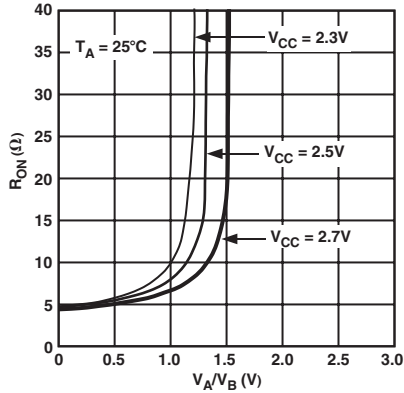

TPC 2. On Resistance vs. Input Voltage

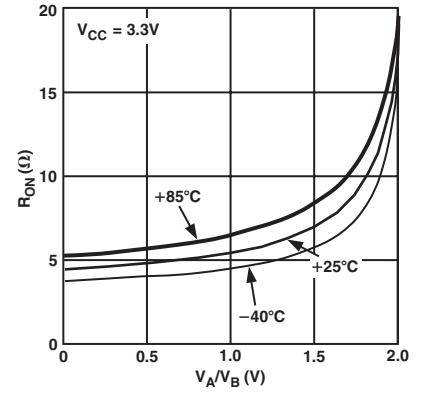

TPC 3. On Resistance vs. Input Voltage for Different Temperatures

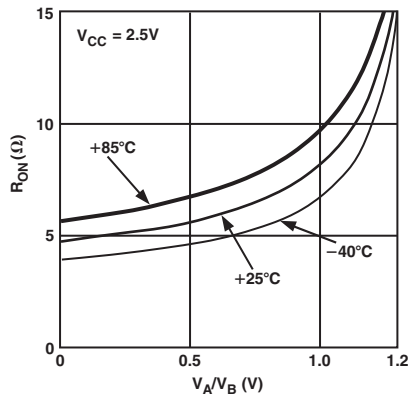

TPC 4. On Resistance vs. Input Voltage for Different Temperatures

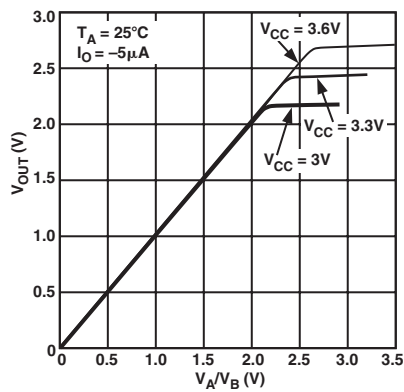

TPC 5. Pass Voltage vs. V_{CC}

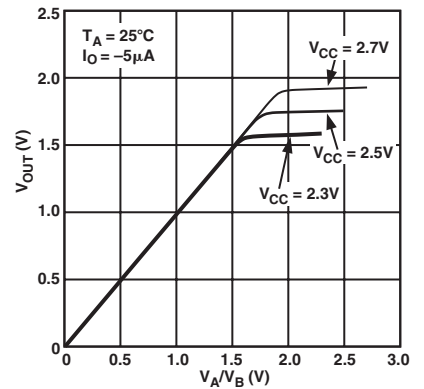

TPC 6. Pass Voltage vs. V_{CC}

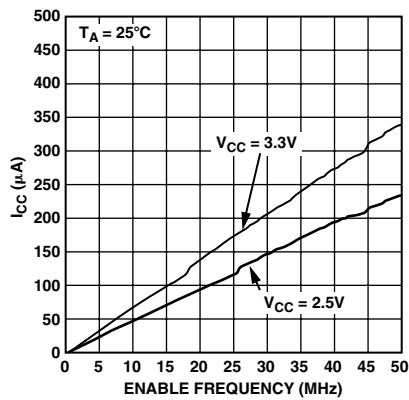

TPC 7. I_{CC} vs. Enable Frequency

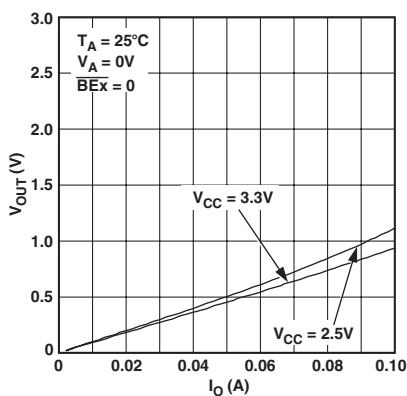

TPC 8. Output Low Characteristic

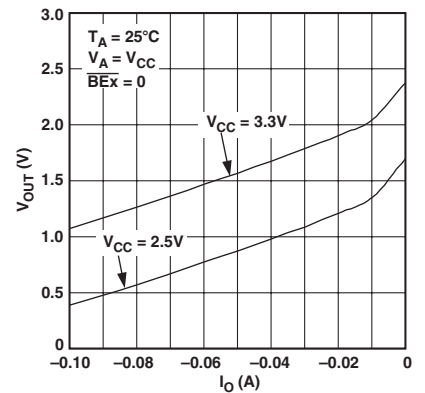

TPC 9. Output High Characteristic

ADG3243

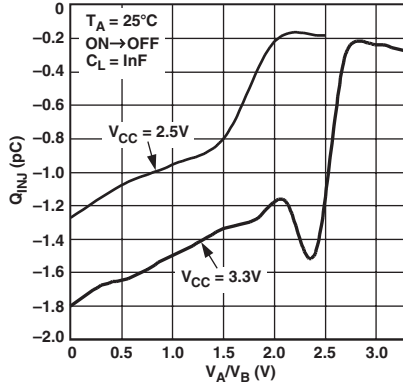

TPC 10. Charge Injection vs. Source Voltage

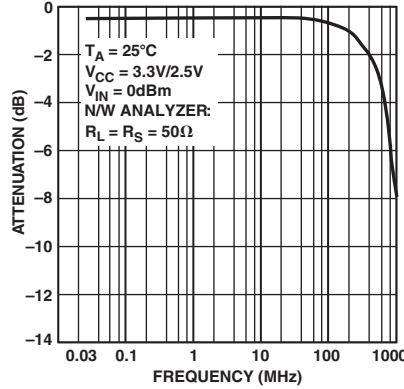

TPC 11. Bandwidth vs. Frequency

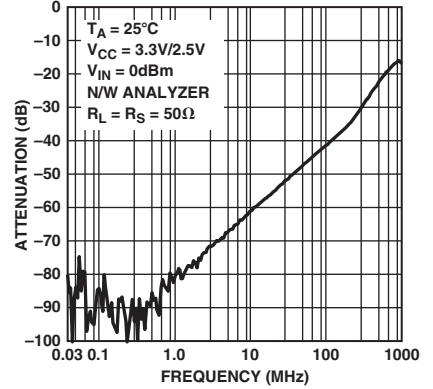

TPC 12. Crosstalk vs. Frequency

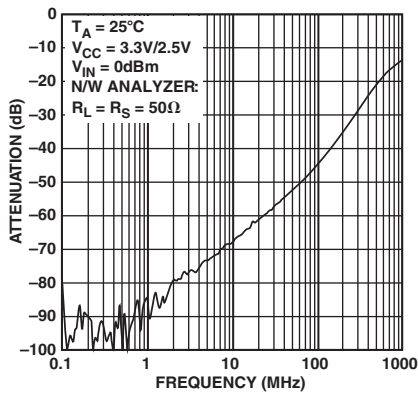

TPC 13. Off Isolation vs. Frequency

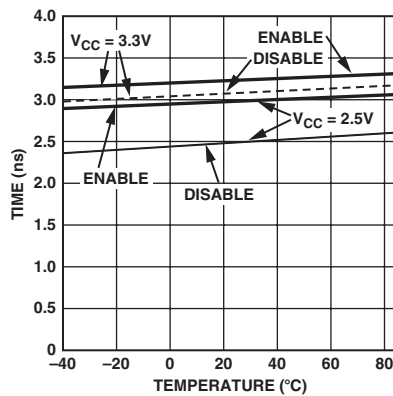

TPC 14. Enable/Disable Time vs. Temperature

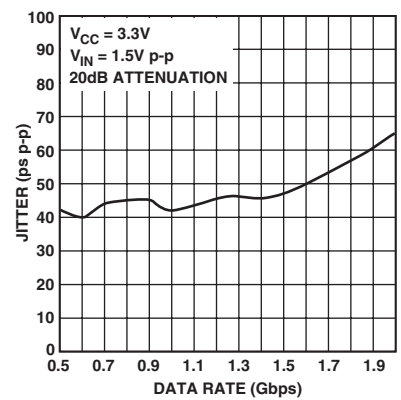

TPC 15. Jitter vs. Data Rate; PRBS 31

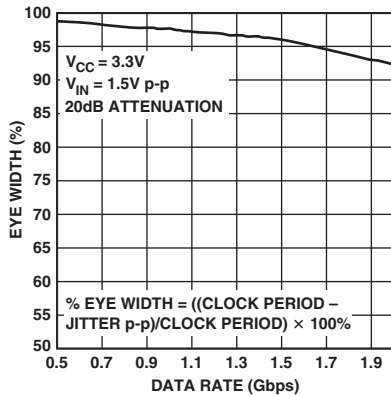

TPC 16. Eye Width vs. Data Rate; PRBS 31

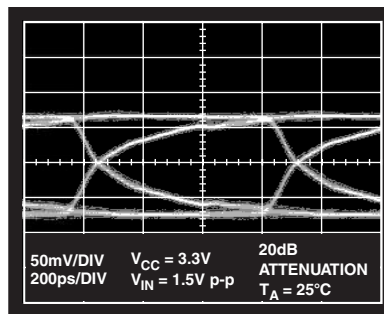

TPC 17. Eye Pattern; 1.5 Gbps, $V_{CC} = 3.3$ V, PRBS 31

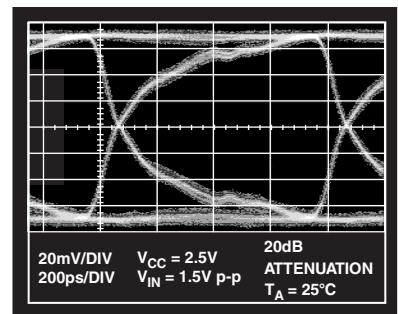

TPC 18. Eye Pattern; 1.244 Gbps, $V_{CC} = 2.5$ V, PRBS 31

TIMING MEASUREMENT INFORMATION

For the following load circuit and waveforms, the notation that is used is V_{IN} and V_{OUT} where

$$V_{IN} = V_A \text{ and } V_{OUT} = V_B \text{ or } V_{IN} = V_B \text{ and } V_{OUT} = V_A$$

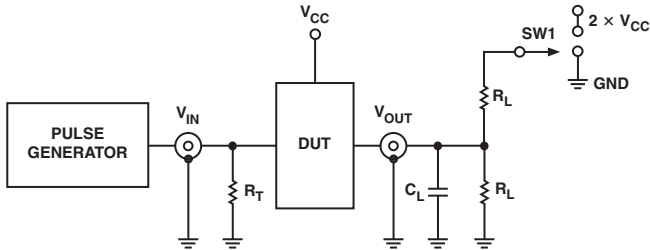

NOTES
 PULSE GENERATOR FOR ALL PULSES: $t_R \leq 2.5\text{ns}$, $t_F \leq 2.5\text{ns}$,
 FREQUENCY $\leq 10\text{MHz}$.
 C_L INCLUDES BOARD, STRAY, AND LOAD CAPACITANCES.
 R_T IS THE TERMINATION RESISTOR, SHOULD BE EQUAL TO Z_{OUT}
 OF THE PULSE GENERATOR.

Figure 1. Load Circuit

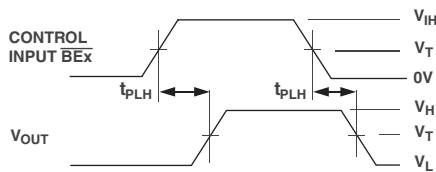

Figure 2. Propagation Delay

Test Conditions

| Symbol | $V_{CC} = 3.3\text{ V} \pm 0.3\text{ V}$ | $V_{CC} = 2.5\text{ V} \pm 0.2\text{ V}$ | Unit |
|--------------|--|--|----------|
| R_L | 500 | 500 | Ω |
| V_{Δ} | 300 | 150 | mV |
| C_L | 50 | 30 | pF |
| V_T | 1.5 | 0.9 | V |

Table II. Switch Position

| Test | S1 |
|-----------------------|-------------------|
| t_{PLZ} , t_{PZL} | $2 \times V_{CC}$ |
| t_{PHZ} , t_{PZH} | GND |

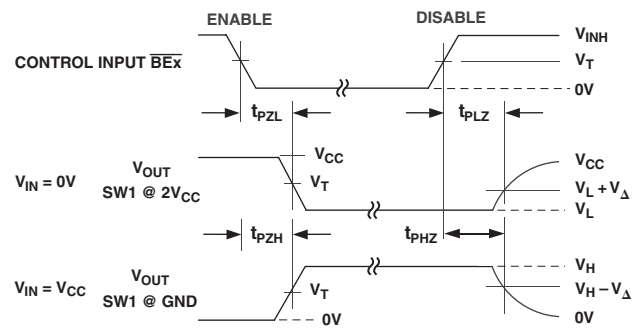

Figure 3. Enable and Disable Times

ADG3243

BUS SWITCH APPLICATIONS

Mixed Voltage Operation, Level Translation

Bus switches can provide an ideal solution for interfacing between mixed voltage systems. The ADG3243 is suitable for applications where voltage translation from 3.3 V technology to a lower voltage technology is needed. This device can translate from 2.5 V to 1.8 V or bidirectionally from 3.3 V directly to 2.5 V.

Figure 4 shows a block diagram of a typical application in which a user needs to interface between a 3.3 V ADC and a 2.5 V microprocessor. The microprocessor may not have 3.3 V tolerant inputs, therefore placing the ADG3243 between the two devices allows the devices to communicate easily. The bus switch directly connects the two blocks, thus introducing minimal propagation delay, timing skew, or noise.

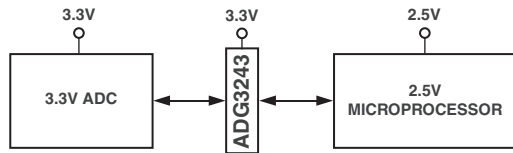

Figure 4. Level Translation between a 3.3 V ADC and a 2.5 V Microprocessor

3.3 V to 2.5 V Translation

When V_{CC} is 3.3 V and the input signal range is 0 V to V_{CC} , the maximum output signal will be clamped to within a voltage threshold below the V_{CC} supply.

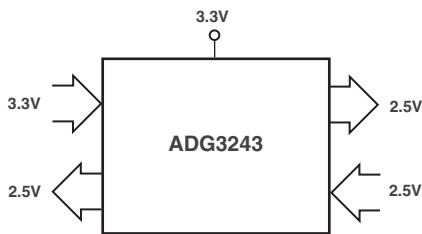

Figure 5. 3.3 V to 2.5 V Voltage Translation

In this case, the output will be limited to 2.5 V, as shown in Figure 6. This device can be used for translation from 2.5 V to 3.3 V devices and also between two 3.3 V devices.

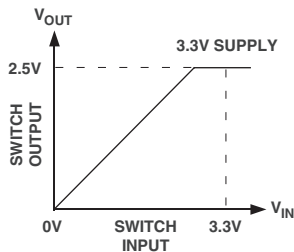

Figure 6. 3.3 V to 2.5 V Voltage Translation

2.5 V to 1.8 V Translation

When V_{CC} is 2.5 V and the input signal range is 0 V to V_{CC} , the maximum output signal will, as before, be clamped to within a voltage threshold below the V_{CC} supply. In this case, the output will be limited to approximately 1.8 V, as shown in Figure 8.

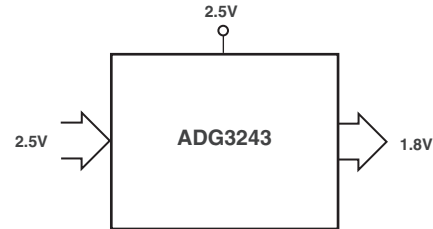

Figure 7. 2.5 V to 1.8 V Voltage Translation

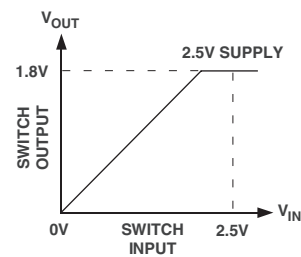

Figure 8. 2.5 V to 1.8 V Voltage Translation

Bus Isolation

A common requirement of bus architectures is low capacitance loading of the bus. Such systems require bus bridge devices that extend the number of loads on the bus without exceeding the specifications. Because the ADG3243 is designed specifically for applications that do not need drive yet require simple logic functions, it solves this requirement. The device isolates access to the bus, thus minimizing capacitance loading.

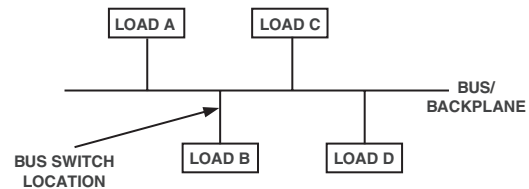

Figure 9. Location of Bus Switched in a Bus Isolation Application

Hot Plug and Hot Swap Isolation

The ADG3243 is suitable for hot swap and hot plug applications. The output signal of the ADG3243 is limited to a voltage that is below the V_{CC} supply, as shown in Figures 6 and 8. Therefore the switch acts like a buffer to take the impact from hot insertion, protecting vital and expensive chipsets from damage.

In hot plug applications, the system cannot be shut down when new hardware is being added. To overcome this, a bus switch can be positioned on the backplane between the bus devices and the hot plug connectors. The bus switch is turned off during hot plug. Figure 10 shows a typical example of this type of application.

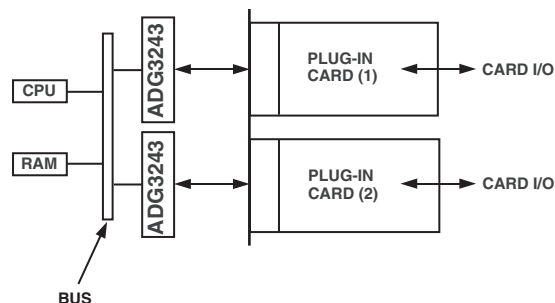

Figure 10. ADG3243 in a Hot Plug Application

There are many systems, such as docking stations, PCI boards for servers, and line cards for telecommunications switches, that require the ability to handle hot swapping. If the bus can be isolated prior to insertion or removal, there is more control over the hot swap event. This isolation can be achieved using bus

switches. The bus switches are positioned on the hot swap card between the connector and the devices. During hot swap, the ground pin of the hot swap card must connect to the ground pin of the backplane before any other signal or power pins.

Analog Switching

Bus switches can be used in many analog switching applications, for example, video graphics. Bus switches can have lower on resistance, smaller ON and OFF channel capacitance, and thus improved frequency performance than their analog counterparts. The bus switch channel itself, consisting solely of an NMOS switch, limits the operating voltage (see TPC 1 for a typical plot), but in many cases, this does not present an issue.

High Impedance during Power-Up/Power-Down

To ensure the high impedance state during power-up or power-down, $\overline{\text{BEx}}$ should be tied to V_{CC} through a pull-up resistor; the minimum value of the resistor is determined by the current-sinking capability of the driver.

OUTLINE DIMENSIONS

8-Lead Small Outline Transistor Package [SOT-23] (RJ-8)

Dimensions shown in millimeters

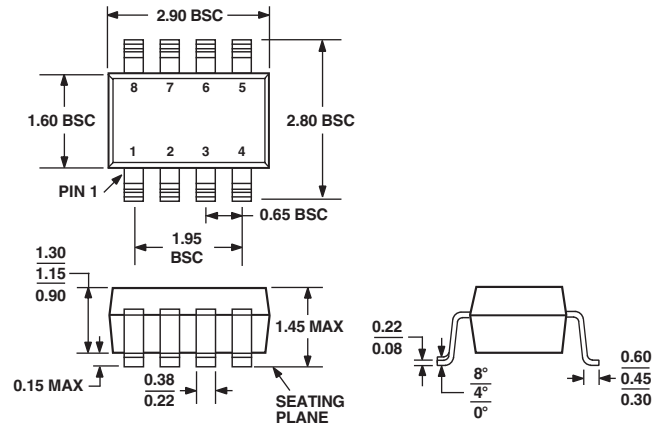

COMPLIANT TO JEDEC STANDARDS MO-178BA

