

To our customers,

---

## Old Company Name in Catalogs and Other Documents

---

On April 1<sup>st</sup>, 2010, NEC Electronics Corporation merged with Renesas Technology Corporation, and Renesas Electronics Corporation took over all the business of both companies. Therefore, although the old company name remains in this document, it is a valid Renesas Electronics document. We appreciate your understanding.

Renesas Electronics website: <http://www.renesas.com>

April 1<sup>st</sup>, 2010  
Renesas Electronics Corporation

Issued by: Renesas Electronics Corporation (<http://www.renesas.com>)

Send any inquiries to <http://www.renesas.com/inquiry>.

---

The Renesas logo, featuring the word "RENESAS" in a bold, sans-serif font with a stylized square icon to the left.

## Notice

1. All information included in this document is current as of the date this document is issued. Such information, however, is subject to change without any prior notice. Before purchasing or using any Renesas Electronics products listed herein, please confirm the latest product information with a Renesas Electronics sales office. Also, please pay regular and careful attention to additional and different information to be disclosed by Renesas Electronics such as that disclosed through our website.
2. Renesas Electronics does not assume any liability for infringement of patents, copyrights, or other intellectual property rights of third parties by or arising from the use of Renesas Electronics products or technical information described in this document. No license, express, implied or otherwise, is granted hereby under any patents, copyrights or other intellectual property rights of Renesas Electronics or others.
3. You should not alter, modify, copy, or otherwise misappropriate any Renesas Electronics product, whether in whole or in part.
4. Descriptions of circuits, software and other related information in this document are provided only to illustrate the operation of semiconductor products and application examples. You are fully responsible for the incorporation of these circuits, software, and information in the design of your equipment. Renesas Electronics assumes no responsibility for any losses incurred by you or third parties arising from the use of these circuits, software, or information.
5. When exporting the products or technology described in this document, you should comply with the applicable export control laws and regulations and follow the procedures required by such laws and regulations. You should not use Renesas Electronics products or the technology described in this document for any purpose relating to military applications or use by the military, including but not limited to the development of weapons of mass destruction. Renesas Electronics products and technology may not be used for or incorporated into any products or systems whose manufacture, use, or sale is prohibited under any applicable domestic or foreign laws or regulations.
6. Renesas Electronics has used reasonable care in preparing the information included in this document, but Renesas Electronics does not warrant that such information is error free. Renesas Electronics assumes no liability whatsoever for any damages incurred by you resulting from errors in or omissions from the information included herein.
7. Renesas Electronics products are classified according to the following three quality grades: “Standard”, “High Quality”, and “Specific”. The recommended applications for each Renesas Electronics product depends on the product’s quality grade, as indicated below. You must check the quality grade of each Renesas Electronics product before using it in a particular application. You may not use any Renesas Electronics product for any application categorized as “Specific” without the prior written consent of Renesas Electronics. Further, you may not use any Renesas Electronics product for any application for which it is not intended without the prior written consent of Renesas Electronics. Renesas Electronics shall not be in any way liable for any damages or losses incurred by you or third parties arising from the use of any Renesas Electronics product for an application categorized as “Specific” or for which the product is not intended where you have failed to obtain the prior written consent of Renesas Electronics. The quality grade of each Renesas Electronics product is “Standard” unless otherwise expressly specified in a Renesas Electronics data sheets or data books, etc.
  - “Standard”: Computers; office equipment; communications equipment; test and measurement equipment; audio and visual equipment; home electronic appliances; machine tools; personal electronic equipment; and industrial robots.
  - “High Quality”: Transportation equipment (automobiles, trains, ships, etc.); traffic control systems; anti-disaster systems; anti-crime systems; safety equipment; and medical equipment not specifically designed for life support.
  - “Specific”: Aircraft; aerospace equipment; submersible repeaters; nuclear reactor control systems; medical equipment or systems for life support (e.g. artificial life support devices or systems), surgical implantations, or healthcare intervention (e.g. excision, etc.), and any other applications or purposes that pose a direct threat to human life.
8. You should use the Renesas Electronics products described in this document within the range specified by Renesas Electronics, especially with respect to the maximum rating, operating supply voltage range, movement power voltage range, heat radiation characteristics, installation and other product characteristics. Renesas Electronics shall have no liability for malfunctions or damages arising out of the use of Renesas Electronics products beyond such specified ranges.
9. Although Renesas Electronics endeavors to improve the quality and reliability of its products, semiconductor products have specific characteristics such as the occurrence of failure at a certain rate and malfunctions under certain use conditions. Further, Renesas Electronics products are not subject to radiation resistance design. Please be sure to implement safety measures to guard them against the possibility of physical injury, and injury or damage caused by fire in the event of the failure of a Renesas Electronics product, such as safety design for hardware and software including but not limited to redundancy, fire control and malfunction prevention, appropriate treatment for aging degradation or any other appropriate measures. Because the evaluation of microcomputer software alone is very difficult, please evaluate the safety of the final products or system manufactured by you.
10. Please contact a Renesas Electronics sales office for details as to environmental matters such as the environmental compatibility of each Renesas Electronics product. Please use Renesas Electronics products in compliance with all applicable laws and regulations that regulate the inclusion or use of controlled substances, including without limitation, the EU RoHS Directive. Renesas Electronics assumes no liability for damages or losses occurring as a result of your noncompliance with applicable laws and regulations.
11. This document may not be reproduced or duplicated, in any form, in whole or in part, without prior written consent of Renesas Electronics.
12. Please contact a Renesas Electronics sales office if you have any questions regarding the information contained in this document or Renesas Electronics products, or if you have any other inquiries.

(Note 1) “Renesas Electronics” as used in this document means Renesas Electronics Corporation and also includes its majority-owned subsidiaries.

(Note 2) “Renesas Electronics product(s)” means any product developed or manufactured by or for Renesas Electronics.

# HD74LV00A

## Quad. 2-input NAND Gates

REJ03D0225–0300Z  
 (Previous ADE-205-240A (Z))  
 Rev.3.00  
 May 20, 2004

### Description

The HD74LV00A has four two-input NAND gates in a 14-pin package.

Low-voltage and high-speed operation is suitable for the battery-powered products (e.g., notebook computers), and the low-power consumption extends the battery life.

### Features

- $V_{CC} = 2.0\text{ V to }5.5\text{ V}$  operation
- All inputs  $V_{IH}$  (Max.) = 5.5 V (@ $V_{CC} = 0\text{ V to }5.5\text{ V}$ )
- All outputs  $V_O$  (Max.) = 5.5 V (@ $V_{CC} = 0\text{ V}$ )
- Typical  $V_{OL}$  ground bounce < 0.8 V (@ $V_{CC} = 3.3\text{ V}$ ,  $T_a = 25^\circ\text{C}$ )
- Typical  $V_{OH}$  undershoot > 2.3 V (@ $V_{CC} = 3.3\text{ V}$ ,  $T_a = 25^\circ\text{C}$ )
- Output current  $\pm 6\text{ mA}$  (@ $V_{CC} = 3.0\text{ V to }3.6\text{ V}$ ),  $\pm 12\text{ mA}$  (@ $V_{CC} = 4.5\text{ V to }5.5\text{ V}$ )
- Ordering Information

Part Name	Package Type	Package Code	Package Abbreviation	Taping Abbreviation (Quantity)
HD74LV00AFPEL	SOP–14 pin(JEITA)	FP–14DAV	FP	EL (2,000 pcs/reel)
HD74LV00ARPEL	SOP–14 pin(JEDEC)	FP–14DNV	RP	EL (2,500 pcs/reel)
HD74LV00ATELL	TSSOP–14 pin	TTP–14DV	T	ELL (2,000 pcs/reel)

Note: Please consult the sales office for the above package availability.

### Function Table

#### Inputs

A	B	Output Y
H	H	L
L	X	H
X	L	H

Note: H: High level  
 L: Low level  
 X: Immaterial

Pin Arrangement

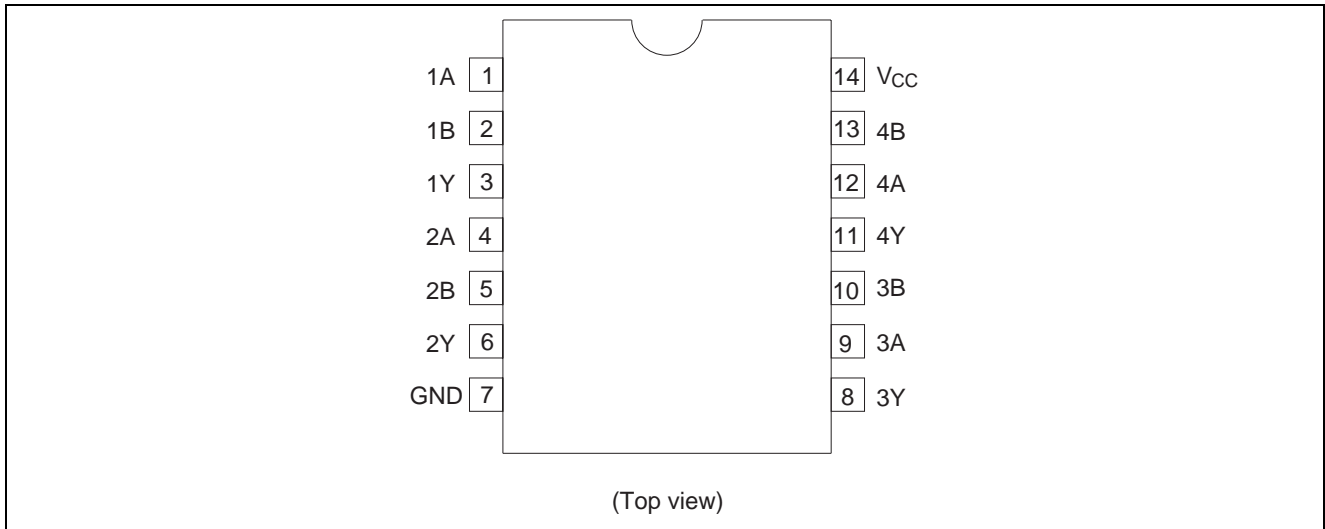

Absolute Maximum Ratings

Item	Symbol	Ratings	Unit	Conditions
Supply voltage range	$V_{CC}$	-0.5 to 7.0	V	
Input voltage range* <sup>1</sup>	$V_I$	-0.5 to 7.0	V	
Output voltage range* <sup>1, 2</sup>	$V_O$	-0.5 to $V_{CC} + 0.5$ -0.5 to 7.0	V	Output: H or L $V_{CC}$ : OFF
Input clamp current	$I_{IK}$	-20	mA	$V_I < 0$
Output clamp current	$I_{OK}$	$\pm 50$	mA	$V_O < 0$ or $V_O > V_{CC}$
Continuous output current	$I_O$	$\pm 25$	mA	$V_O = 0$ to $V_{CC}$
Continuous current through $V_{CC}$ or GND	$I_{CC}$ or $I_{GND}$	$\pm 50$	mA	
Maximum power dissipation at $T_a = 25^\circ\text{C}$ (in still air)* <sup>3</sup>	$P_T$	785 500	mW	SOP TSSOP
Storage temperature	$T_{stg}$	-65 to 150	$^\circ\text{C}$	

Notes: The absolute maximum ratings are values, which must not individually be exceeded, and furthermore, no two of which may be realized at the same time.

1. The input and output voltage ratings may be exceeded if the input and output clamp-current ratings are observed.
2. This value is limited to 5.5 V maximum.
3. The maximum package power dissipation was calculated using a junction temperature of 150°C.

**Recommended Operating Conditions**

Item	Symbol	Min	Max	Unit	Conditions
Supply voltage range	$V_{CC}$	2.0	5.5	V	
Input voltage range	$V_I$	0	5.5	V	
Output voltage range	$V_O$	0	$V_{CC}$	V	
Output current	$I_{OH}$	—	-50	$\mu A$	$V_{CC} = 2.0 V$
		—	-2	mA	$V_{CC} = 2.3 \text{ to } 2.7 V$
		—	-6		$V_{CC} = 3.0 \text{ to } 3.6 V$
		—	-12		$V_{CC} = 4.5 \text{ to } 5.5 V$
	$I_{OL}$	—	50	$\mu A$	$V_{CC} = 2.0 V$
		—	2	mA	$V_{CC} = 2.3 \text{ to } 2.7 V$
		—	6		$V_{CC} = 3.0 \text{ to } 3.6 V$
		—	12		$V_{CC} = 4.5 \text{ to } 5.5 V$
Input transition rise or fall rate	$\Delta t / \Delta v$	0	200	ns/V	$V_{CC} = 2.3 \text{ to } 2.7 V$
		0	100		$V_{CC} = 3.0 \text{ to } 3.6 V$
		0	20		$V_{CC} = 4.5 \text{ to } 5.5 V$
Operating free-air temperature	$T_a$	-40	85	$^{\circ}C$	

Note: Unused or floating inputs must be held high or low.

**Logic Diagram**

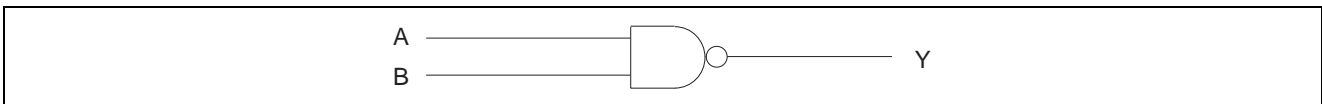

DC Electrical Characteristics

Ta = -40 to 85°C

Item	Symbol	V <sub>CC</sub> (V)*	Min	Typ	Max	Unit	Test Conditions		
Input voltage	V <sub>IH</sub>	2.0	1.5	—	—	V			
		2.3 to 2.7	V <sub>CC</sub> × 0.7	—	—				
		3.0 to 3.6	V <sub>CC</sub> × 0.7	—	—				
		4.5 to 5.5	V <sub>CC</sub> × 0.7	—	—				
	V <sub>IL</sub>	2.0	—	—	0.5				
		2.3 to 2.7	—	—	V <sub>CC</sub> × 0.3				
		3.0 to 3.6	—	—	V <sub>CC</sub> × 0.3				
		4.5 to 5.5	—	—	V <sub>CC</sub> × 0.3				
Output voltage	V <sub>OH</sub>	Min to Max	V <sub>CC</sub> - 0.1	—	—	V	I <sub>OH</sub> = -50 μA		
		2.3	2.0	—	—		I <sub>OH</sub> = -2 mA		
		3.0	2.48	—	—		I <sub>OH</sub> = -6 mA		
		4.5	3.8	—	—		I <sub>OH</sub> = -12 mA		
	V <sub>OL</sub>	Min to Max	—	—	0.1		I <sub>OL</sub> = 50 μA		
		2.3	—	—	0.4		I <sub>OL</sub> = 2 mA		
		3.0	—	—	0.44		I <sub>OL</sub> = 6 mA		
		4.5	—	—	0.55		I <sub>OL</sub> = 12 mA		
	Input current	I <sub>IN</sub>	0 to 5.5	—	—		±1	μA	V <sub>IN</sub> = 5.5 V or GND
	Quiescent supply current	I <sub>CC</sub>	5.5	—	—		20	μA	V <sub>IN</sub> = V <sub>CC</sub> or GND, I <sub>O</sub> = 0
	Output leakage current	I <sub>OFF</sub>	0	—	—		5	μA	V <sub>I</sub> or V <sub>O</sub> = 0 V to 5.5 V
	Input capacitance	C <sub>IN</sub>	3.3	—	3.3		—	pF	V <sub>I</sub> = V <sub>CC</sub> or GND

Note: For conditions shown as Min or Max, use the appropriate values under recommended operating conditions.

Switching Characteristics

V<sub>CC</sub> = 2.5 ± 0.2 V

Item	Symbol	Ta = 25°C			Ta = -40 to 85°C		Unit	Test Conditions	FROM (Input)	TO (Output)
		Min	Typ	Max	Min	Max				
Propagation delay time	t <sub>PLH</sub>	—	7.1	12.9	1.0	15.0	ns	C <sub>L</sub> = 15 pF	A or B	Y
	t <sub>PHL</sub>	—	9.6	16.6	1.0	20.0				

V<sub>CC</sub> = 3.3 ± 0.3 V

Item	Symbol	Ta = 25°C			Ta = -40 to 85°C		Unit	Test Conditions	FROM (Input)	TO (Output)
		Min	Typ	Max	Min	Max				
Propagation delay time	t <sub>PLH</sub>	—	5.0	7.9	1.0	9.5	ns	C <sub>L</sub> = 15 pF	A or B	Y
	t <sub>PHL</sub>	—	6.9	11.4	1.0	13.0				

V<sub>CC</sub> = 5.0 ± 0.5 V

Item	Symbol	Ta = 25°C			Ta = -40 to 85°C		Unit	Test Conditions	FROM (Input)	TO (Output)
		Min	Typ	Max	Min	Max				
Propagation delay time	t <sub>PLH</sub>	—	3.6	5.5	1.0	6.5	ns	C <sub>L</sub> = 15 pF	A or B	Y
	t <sub>PHL</sub>	—	4.9	7.5	1.0	8.5				

**Operating Characteristics**

$C_L = 50 \text{ pF}$

Item	Symbol	$V_{CC} \text{ (V)}$	$T_a = 25^\circ\text{C}$			Unit	Test Conditions
			Min	Typ	Max		
Power dissipation capacitance	$C_{PD}$	3.3	—	9.5	—	pF	f = 10 MHz
		5.0	—	11.0	—		

**Noise Characteristics**

$C_L = 50 \text{ pF}$

Item	Symbol	$V_{CC} \text{ (V)}$	$T_a = 25^\circ\text{C}$			Unit	Test Conditions
			Min	Typ	Max		
Quiet output, maximum dynamic $V_{OL}$	$V_{OL(P)}$	3.3	—	0.2	0.8	V	
Quiet output, minimum dynamic $V_{OL}$	$V_{OL(V)}$	3.3	—	-0.1	-0.8	V	
Quiet output, minimum dynamic $V_{OH}$	$V_{OH(V)}$	3.3	—	3.1	—	V	
High-level dynamic input voltage	$V_{IH(D)}$	3.3	2.31	—	—	V	
Low-level dynamic input voltage	$V_{IL(D)}$	3.3	—	—	0.99	V	

Test Circuit

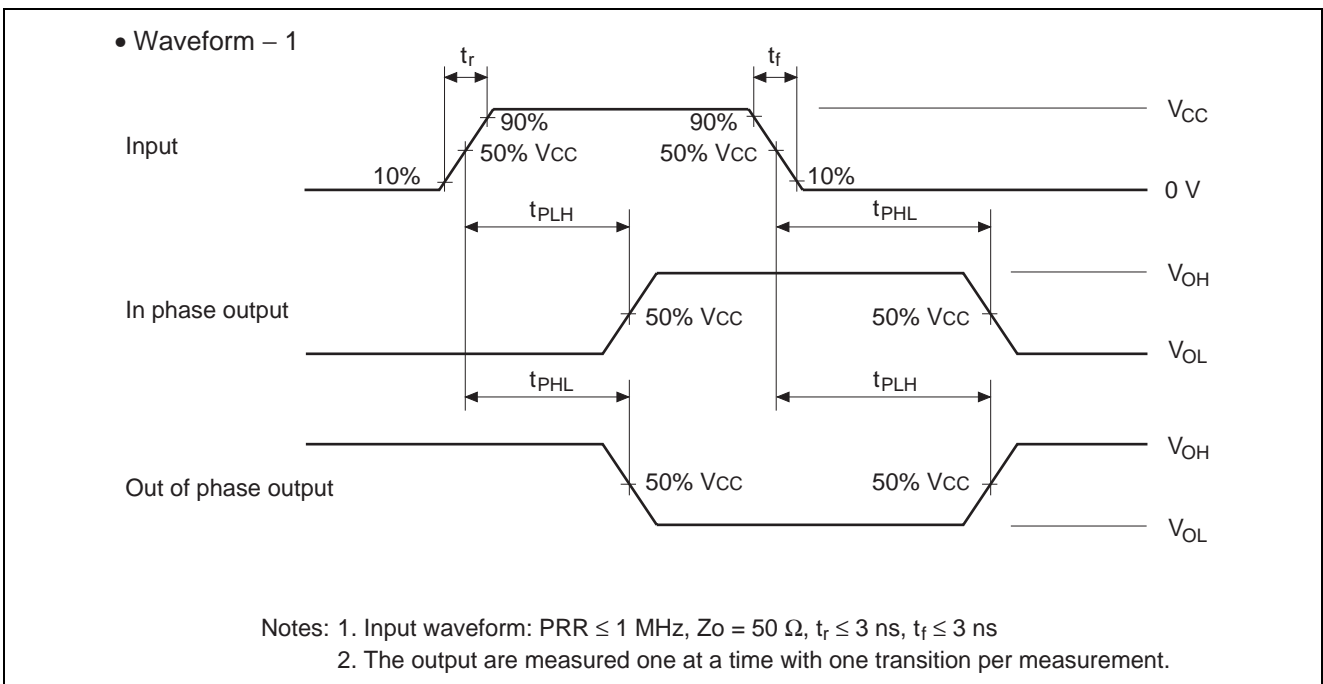
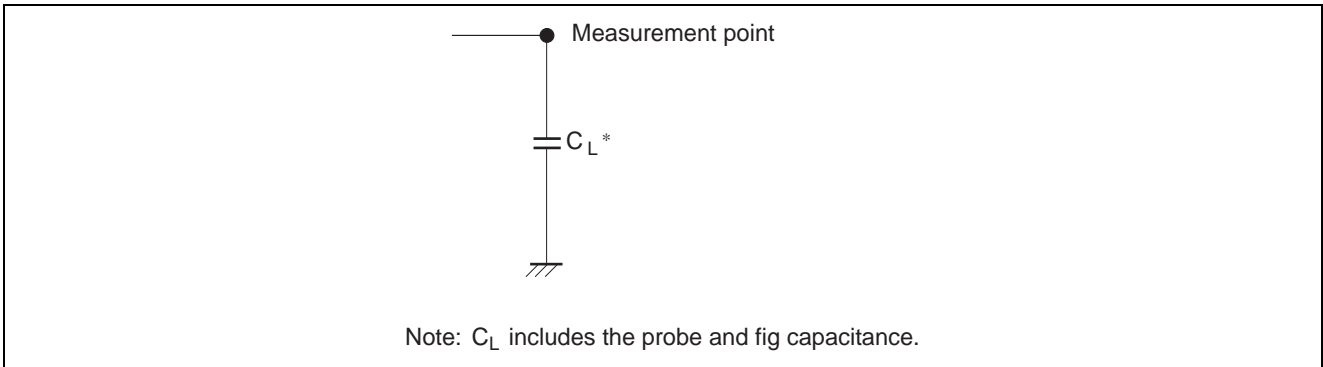



Package Dimensions

As of January, 2003  
Unit: mm

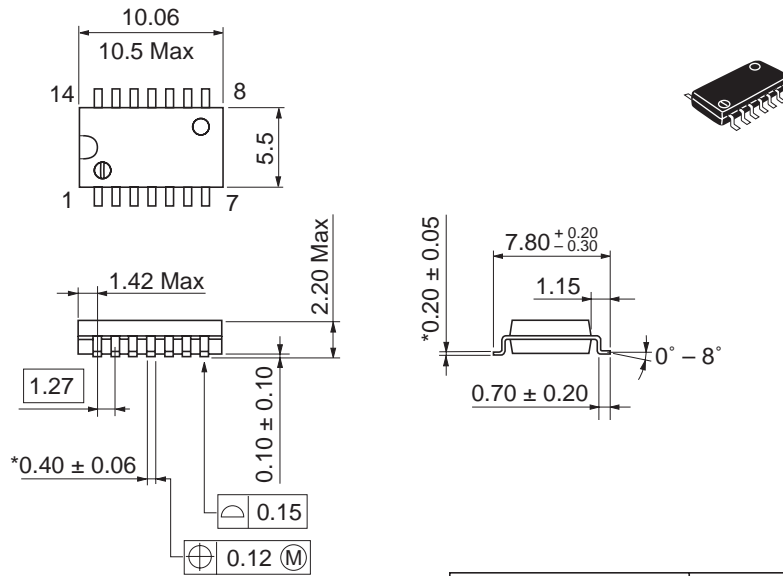

\*Ni/Pd/Au plating

Package Code	FP-14DAV
JEDEC	—
JEITA	Conforms
Mass (reference value)	0.23 g

As of January, 2003  
Unit: mm

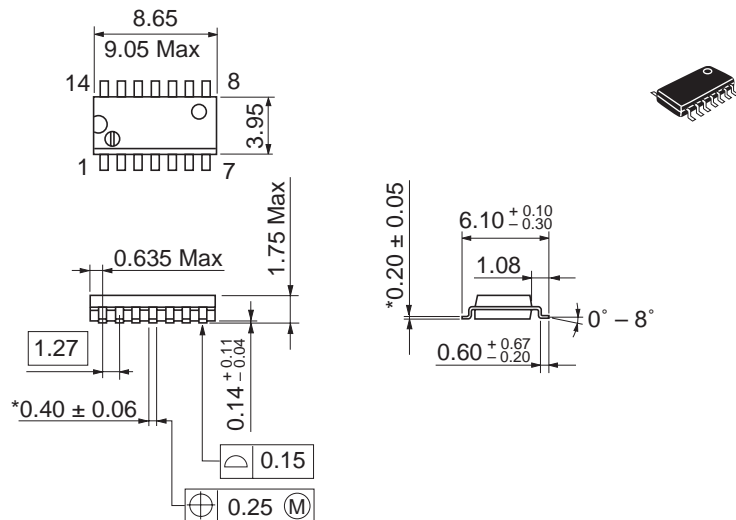

\*Ni/Pd/Au plating

Package Code	FP-14DNV
JEDEC	Conforms
JEITA	Conforms
Mass (reference value)	0.13 g

As of January, 2003  
Unit: mm

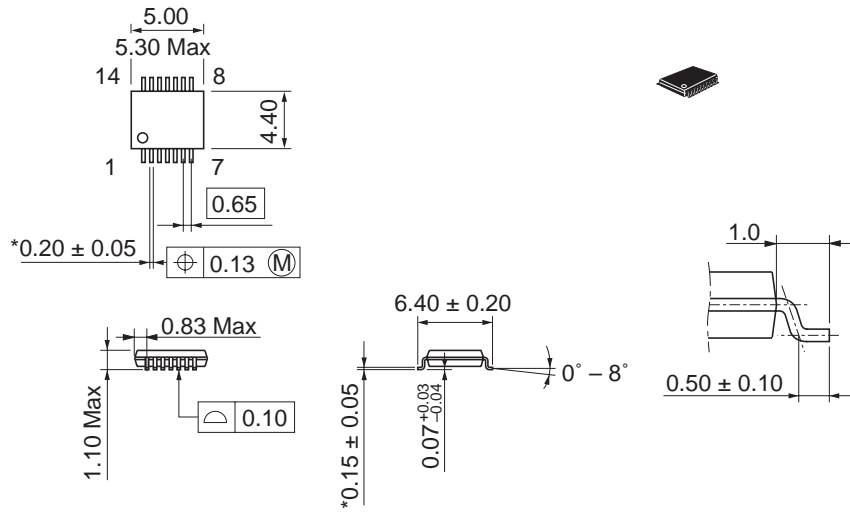

\*Ni/Pd/Au plating

Package Code	TTP-14DV
JEDEC	—
JEITA	—
Mass (reference value)	0.05 g

## RENESAS Technology Corp. Sales Strategic Planning Div. Nippon Bldg., 2-6-2, Ohte-machi, Chiyoda-ku, Tokyo 100-0004, Japan

Keep safety first in your circuit designs!

1. Renesas Technology Corp. puts the maximum effort into making semiconductor products better and more reliable, but there is always the possibility that trouble may occur with them. Trouble with semiconductors may lead to personal injury, fire or property damage. Remember to give due consideration to safety when making your circuit designs, with appropriate measures such as (i) placement of substitutive, auxiliary circuits, (ii) use of nonflammable material or (iii) prevention against any malfunction or mishap.

Notes regarding these materials

1. These materials are intended as a reference to assist our customers in the selection of the Renesas Technology Corp. product best suited to the customer's application; they do not convey any license under any intellectual property rights, or any other rights, belonging to Renesas Technology Corp. or a third party.
2. Renesas Technology Corp. assumes no responsibility for any damage, or infringement of any third-party's rights, originating in the use of any product data, diagrams, charts, programs, algorithms, or circuit application examples contained in these materials.
3. All information contained in these materials, including product data, diagrams, charts, programs and algorithms represents information on products at the time of publication of these materials, and are subject to change by Renesas Technology Corp. without notice due to product improvements or other reasons. It is therefore recommended that customers contact Renesas Technology Corp. or an authorized Renesas Technology Corp. product distributor for the latest product information before purchasing a product listed herein.  
The information described here may contain technical inaccuracies or typographical errors.  
Renesas Technology Corp. assumes no responsibility for any damage, liability, or other loss rising from these inaccuracies or errors.  
Please also pay attention to information published by Renesas Technology Corp. by various means, including the Renesas Technology Corp. Semiconductor home page (<http://www.renesas.com>).
4. When using any or all of the information contained in these materials, including product data, diagrams, charts, programs, and algorithms, please be sure to evaluate all information as a total system before making a final decision on the applicability of the information and products. Renesas Technology Corp. assumes no responsibility for any damage, liability or other loss resulting from the information contained herein.
5. Renesas Technology Corp. semiconductors are not designed or manufactured for use in a device or system that is used under circumstances in which human life is potentially at stake. Please contact Renesas Technology Corp. or an authorized Renesas Technology Corp. product distributor when considering the use of a product contained herein for any specific purposes, such as apparatus or systems for transportation, vehicular, medical, aerospace, nuclear, or undersea repeater use.
6. The prior written approval of Renesas Technology Corp. is necessary to reprint or reproduce in whole or in part these materials.
7. If these products or technologies are subject to the Japanese export control restrictions, they must be exported under a license from the Japanese government and cannot be imported into a country other than the approved destination.  
Any diversion or reexport contrary to the export control laws and regulations of Japan and/or the country of destination is prohibited.
8. Please contact Renesas Technology Corp. for further details on these materials or the products contained therein.



### RENESAS SALES OFFICES

<http://www.renesas.com>

**Renesas Technology America, Inc.**  
450 Holger Way, San Jose, CA 95134-1368, U.S.A  
Tel: <1> (408) 382-7500 Fax: <1> (408) 382-7501

**Renesas Technology Europe Limited.**  
Dukes Meadow, Millboard Road, Bourne End, Buckinghamshire, SL8 5FH, United Kingdom  
Tel: <44> (1628) 585 100, Fax: <44> (1628) 585 900

**Renesas Technology Europe GmbH**  
Dornacher Str. 3, D-85622 Feldkirchen, Germany  
Tel: <49> (89) 380 70 0, Fax: <49> (89) 929 30 11

**Renesas Technology Hong Kong Ltd.**  
7/F., North Tower, World Finance Centre, Harbour City, Canton Road, Hong Kong  
Tel: <852> 2265-6688, Fax: <852> 2375-6836

**Renesas Technology Taiwan Co., Ltd.**  
FL 10, #99, Fu-Hsing N. Rd., Taipei, Taiwan  
Tel: <886> (2) 2715-2888, Fax: <886> (2) 2713-2999

**Renesas Technology (Shanghai) Co., Ltd.**  
26/F., Ruijin Building, No.205 Maoming Road (S), Shanghai 200020, China  
Tel: <86> (21) 6472-1001, Fax: <86> (21) 6415-2952

**Renesas Technology Singapore Pte. Ltd.**  
1, Harbour Front Avenue, #06-10, Keppel Bay Tower, Singapore 098632  
Tel: <65> 6213-0200, Fax: <65> 6278-8001