

**SURFACE MOUNT SILICON RECTIFIER**

VOLTAGE RANGE 50 to 1000 Volts CURRENT 0.5 Ampere

**FEATURES**

- \* Ideal for surface mounted applications
- \* Low leakage current
- \* Metallurgically bonded construction
- \* Mounting position: Any
- \* Weight: 0.016 gram

**MECHANICAL DATA**

- \* Epoxy : Device has UL flammability classification 94V-0



SOD-123F

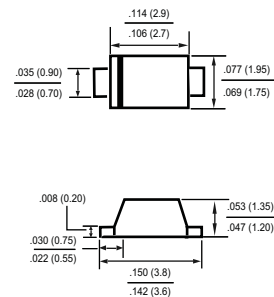

Dimensions in inches and (millimeters)

**MAXIMUM RATINGS AND ELECTRICAL CHARACTERISTICS**

Ratings at 25 °C ambient temperature unless otherwise specified.  
resistive or inductive load.

MAXIMUM RATINGS (@ TA=25 °C unless otherwise noted)

RATINGS	SYMBOL	05A1	05A2	05A3	05A4	05A5	05A6	05A7	UNITS
Maximum Recurrent Peak Reverse Voltage	V <sub>RRM</sub>	50	100	200	400	600	800	1000	Volts
Maximum RMS Voltage	V <sub>RMS</sub>	35	70	140	280	420	560	700	Volts
Maximum DC Blocking Voltage	V <sub>DC</sub>	50	100	200	400	600	800	1000	Volts
Maximum Average Forward Rectified Current at TA = 55°C	I <sub>O</sub>	0.5							Amps
Peak Forward Surge Current IFM(surge): 8.3 ms single half sine-wave superimposed on rated load (JEDEC method)	I <sub>FSM</sub>	15							Amps
Current Squarad Time	i <sup>2</sup> T	0.9							A <sup>2</sup> /Sec
Typical Thermal Resistance (Note 3)	R <sub>θJA</sub>	85							°C/W
	R <sub>θJL</sub>	25					30		
Typical Junction Capacitance (Note 1)	C <sub>J</sub>	8							pF
Operating and Storage Temperature Range	T <sub>J</sub> , T <sub>STG</sub>	-55 to + 150							°C

ELECTRICAL CHARACTERISTICS (@TA=25 °C unless otherwise noted)

CHARACTERISTICS	SYMBOL	05A1	05A2	05A3	05A4	05A5	05A6	05A7	UNITS
Maximum Forward Voltage at 0.5A DC	V <sub>F</sub>	1.0							Volts
Maximum Full Load Reverse Current, Full cycle Average at TA=55°C	I <sub>R</sub>	30							uAmps
Maximum DC Average Reverse Current at Rated DC Blocking Voltage		1.0							uAmps
		50							uAmps

- NOTES : 1. Measured at 1.0 MHz and applied average voltage of 4.0VDC  
 2. "Fully ROHS compliant", "100% Sn plating (Pb-free)".  
 3. Thermal Resistance: Mounted on PCB.

2014-11  
REV:B

## RATING AND CHARACTERISTICS CURVES ( 05A1 THRU 05A7 )

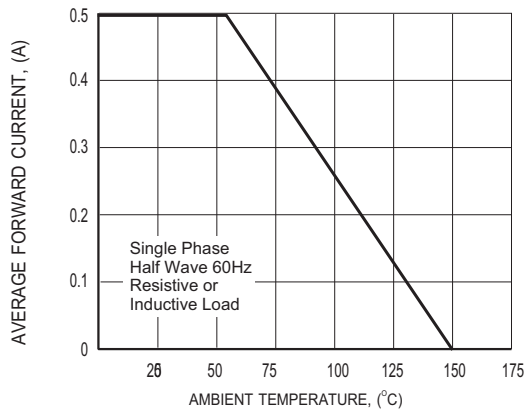

FIG.1 TYPICAL FORWARD CURRENT DERATING CURVE

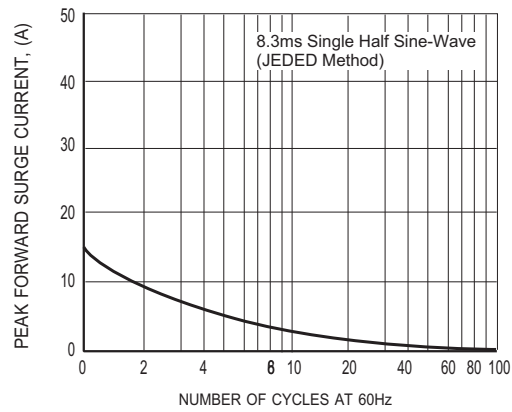

FIG.2 MAXIMUM NON-REPETITIVE FORWARD SURGE CURRENT

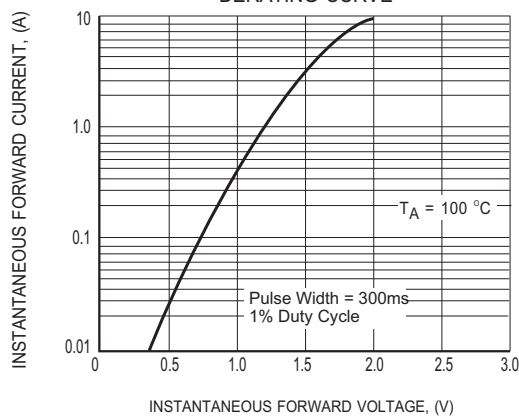

FIG.3 TYPICAL INSTANTANEOUS FORWARD CHARACTERISTICS

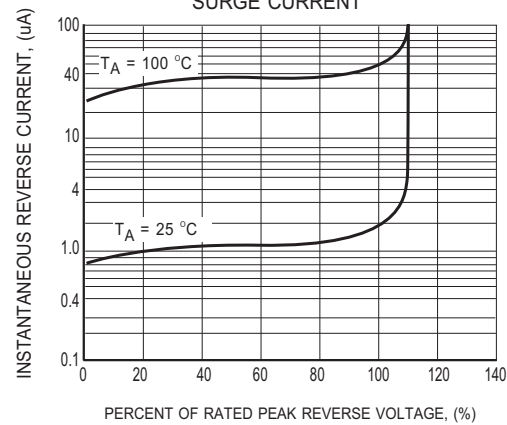

FIG.4 TYPICAL REVERSE CHARACTERISTICS

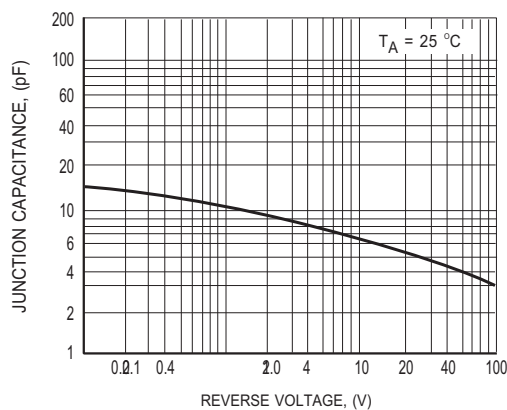
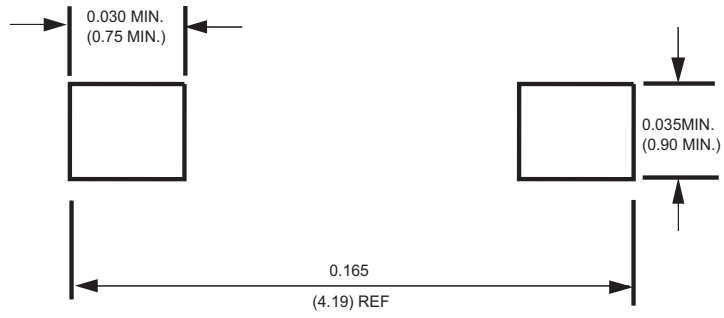

FIG.5 TYPICAL JUNCTION CAPACITANCE



## Mounting Pad Layout



Dimensions in inches and (millimeters)



## Marking Description

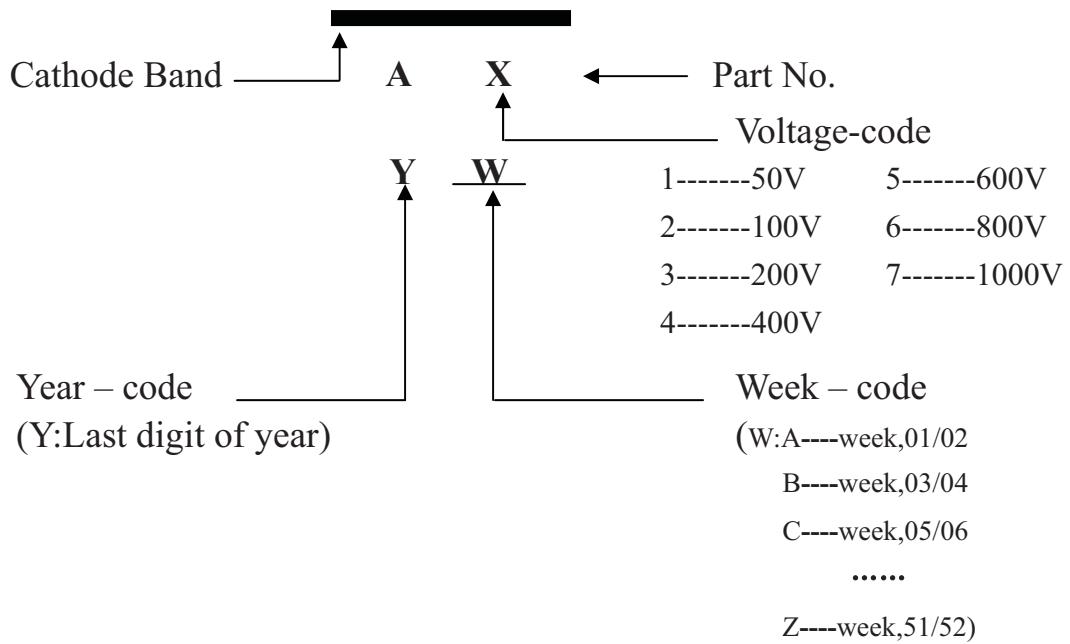

## PACKAGING OF DIODE AND BRIDGE RECTIFIERS

### REEL PACK

PACKAGE	PACKING CODE	EA PER REEL	EA PER INNER BOX	COMPONENT SPACE (mm)	TAPE SPACE (mm)	REEL DIA (mm)	CARTON SIZE (mm)	EA PER CARTON	GROSS WEIGHT(Kg)
SOD-123F/ SOD-123FL	-W	3,000	15,000	---	---	178	390*205*31	120,000	6.964

## DISCLAIMER NOTICE

Rectron Inc reserves the right to make changes without notice to any product specification herein, to make corrections, modifications, enhancements or other changes. Rectron Inc or anyone on its behalf assumes no responsibility or liability for any errors or inaccuracies. Data sheet specifications and its information contained are intended to provide a product description only. "Typical" parameters which may be included on RECTRON data sheets and/ or specifications can and do vary in different applications and actual performance may vary over time. Rectron Inc does not assume any liability arising out of the application or use of any product or circuit.

Rectron products are not designed, intended or authorized for use in medical, life-saving implant or other applications intended for life-sustaining or other related applications where a failure or malfunction of component or circuitry may directly or indirectly cause injury or threaten a life without expressed written approval of Rectron Inc. Customers using or selling Rectron components for use in such applications do so at their own risk and shall agree to fully indemnify Rectron Inc and its subsidiaries harmless against all claims, damages and expenditures.

