

## FO converters - PSI-MOS-RS232/FO 660 E - 2708368

Please be informed that the data shown in this PDF Document is generated from our Online Catalog. Please find the complete data in the user's documentation. Our General Terms of Use for Downloads are valid (<http://phoenixcontact.com/download>)



FO converter with integrated optical diagnostics, alarm contact, for RS-232 interfaces up to 115.2 kbps, terminal device with one FO interface (FSMA), 660 nm, for polymer/PCF fiber cable

### Your advantages

- ✓ Supply voltage and data signals routed through via DIN rail connectors
- ✓ Connections can be plugged in using a COMBICON screw terminal block
- ✓ Redundant power supply possible by means of optional system power supply unit
- ✓ High-quality electrical isolation between all interfaces (RS-232 // fiber optic ports // power supply // DIN rail connector)
- ✓ Approved for use in zone 2
- ✓ Integrated optical diagnostics for continuous monitoring of fiber optic paths
- ✓ Intrinsically safe fiber optic interface (Ex op is) for direct connection to devices in zone 1
- ✓ Floating switch contact for leading alarm generation in relation to critical fiber optic paths
- ✓ Automatic data rate detection for all data rates up to 115.2 kbps
- ✓ Shipbuilding approval in accordance with DNV GL



Ex RS-232



### Key Commercial Data

Packing unit	1 pc
GTIN	 4 017918 974060
GTIN	4017918974060

### Technical data

#### Note

Utilization restriction	EMC: class A product, see manufacturer's declaration in the download area
-------------------------	---

#### Dimensions

Width	35 mm
Height	99 mm
Depth	105 mm

# FO converters - PSI-MOS-RS232/FO 660 E - 2708368

## Technical data

### Ambient conditions

Ambient temperature (operation)	-20 °C ... 60 °C
Ambient temperature (storage/transport)	-40 °C ... 85 °C
Permissible humidity (operation)	30 % ... 95 % (non-condensing)
Altitude	≤ 5000 m (For restrictions, see the manufacturer's declaration for altitude operation)
Degree of protection	IP20
Noise immunity	EN 61000-6-2:2005

### General

Transmission channels	2 (1/1), RxD, TxD, full duplex
Bit distortion, input	± 35 % (permitted)
Bit distortion, output	< 6.25 %
Electrical isolation	VCC // V.24 (RS-232)
Test voltage data interface/power supply	1.5 kV <sub>rms</sub> (50 Hz, 1 min.)
Electromagnetic compatibility	Conformance with EMC Directive 2014/30/EU
Noise emission	EN 55011
Net weight	233.3 g
Housing material	PA 6.6-FR
Color	green
MTBF	485 Years (Telcordia standard, 25°C temperature, 21% operating cycle (5 days a week, 8 hours a day))
	91 Years (Telcordia standard, 40°C temperature, 34.25% operating cycle (5 days a week, 12 hours a day))

### Power supply

Nominal supply voltage	24 V DC (With UL approval)
Supply voltage range	18 V DC ... 30 V DC
Max. current consumption	120 mA
Typical current consumption	100 mA (24 V DC)
Connection method	COMBICON plug-in screw terminal block

### Interfaces

Interface 1	V.24 (RS-232) interface in acc. with ITU-T V.28, EIA/TIA-232, DIN 66259-1
Connection method	D-SUB 9 plug
Transmission medium	Copper
Transmission length	≤ 15 m
Conductor cross section solid min.	0.2 mm <sup>2</sup>
Conductor cross section solid max.	2.5 mm <sup>2</sup>
Conductor cross section flexible min.	0.2 mm <sup>2</sup>
Conductor cross section flexible max.	2.5 mm <sup>2</sup>
Conductor cross section AWG min.	24
Conductor cross section AWG max.	14
Serial transmission speed	115.2 kbps (NRZ)

# FO converters - PSI-MOS-RS232/FO 660 E - 2708368

## Technical data

### Optical interface FO

Transmit capacity, minimum	-4.6 dBm (980/1000 µm)
	-16.6 dBm (200/230 µm)
Minimum receiver sensitivity	-31.2 dBm
Wavelength	660 nm
Transmission length incl. 3 dB system reserve	100 m (With F-P 980/1000 230 dB/km with quick mounting connector)
	800 m (With F-K 200/230 10 dB/km with quick mounting connector)
Transmission medium	Polymer fiber
	PCF fiber
Transmission protocol	Transparent to protocol for RS-232 interface
Connection method	F-SMA

### Digital outputs

Output name	Relay output
Output description	Alarm output
Number of outputs	1
Maximum switching voltage	60 V DC
	42 V AC
Limiting continuous current	0.46 A

### Conformance/approvals

Designation	CE
Identification	CE-compliant
Designation	EAC
Identification	EAC
Designation	ATEX
Identification	# II 3 G Ex nA nC IIC T4 Gc X
Additional text	Please follow the special installation instructions in the documentation!
Designation	ATEX
Identification	# II (2) G [Ex op is Gb] IIC
	# II (2) D [Ex op is Db] IIIC
Certificate	PTB 06 ATEX 2042 U
Additional text	Please follow the special installation instructions in the documentation!
Designation	UL, USA/Canada
Identification	Class I, Zone 2, AEx nc IIC T5
	Class I, Zone 2, Ex nC nL IIC T5 X
	Class I, Div. 2, Groups A, B, C, D
Designation	Corrosive gas test
Identification	ISA-S71.04-1985 G3 Harsh Group A
Designation	Shipbuilding
Identification	DNV GL
Temperature	B
Humidity	A

## FO converters - PSI-MOS-RS232/FO 660 E - 2708368

### Technical data

#### Conformance/approvals

Vibration	A
EMC	B
Enclosure	Required protection according to the Rules shall be provided upon installation on board

#### Standards and Regulations

Electromagnetic compatibility	Conformance with EMC Directive 2014/30/EU
Type of test	Vibration resistance in acc. with EN 60068-2-6/IEC 60068-2-6
Test result	5g, 10...150 Hz, 2.5 h, in XYZ direction
Type of test	Shock in acc. with EN 60068-2-27/IEC 60068-2-27
Test result	15g, 11 ms period, half-sine shock pulse
Noise emission	EN 55011
Noise immunity	EN 61000-6-2:2005
Free from substances that could impair the application of coating	according to P-VW 3.10.7 57 65 0 VW-AUDI-Seat central standard
Connection in acc. with standard	CUL
Standards/regulations	EN 61000-4-2
Contact discharge	± 6 kV
Standards/regulations	EN 61000-4-3
	EN 61000-4-4
Comments	Criterion B
Standards/regulations	EN 61000-4-5
Signal	± 1 kV
Standards/regulations	EN 55011
	EN 61000-4-6
Shock	15g in all directions in acc. with IEC 60068-2-27
Vibration (operation)	in acc. with IEC 60068-2-6: 5g, 150 Hz

#### Environmental Product Compliance

REACH SVHC	Lead 7439-92-1
China RoHS	Environmentally Friendly Use Period = 50 years
	For details about hazardous substances go to tab "Downloads", Category "Manufacturer's declaration"

### Drawings

# FO converters - PSI-MOS-RS232/FO 660 E - 2708368

Application drawing

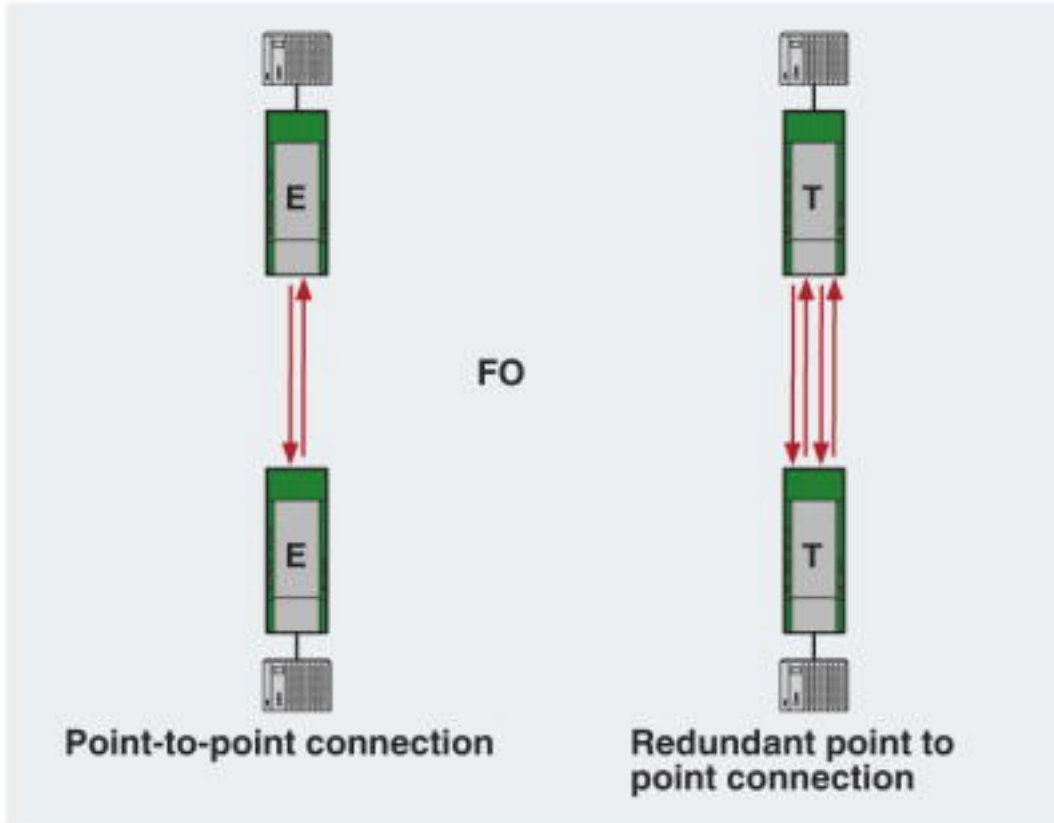

Redundant point-to-point connection

# FO converters - PSI-MOS-RS232/FO 660 E - 2708368

Application drawing

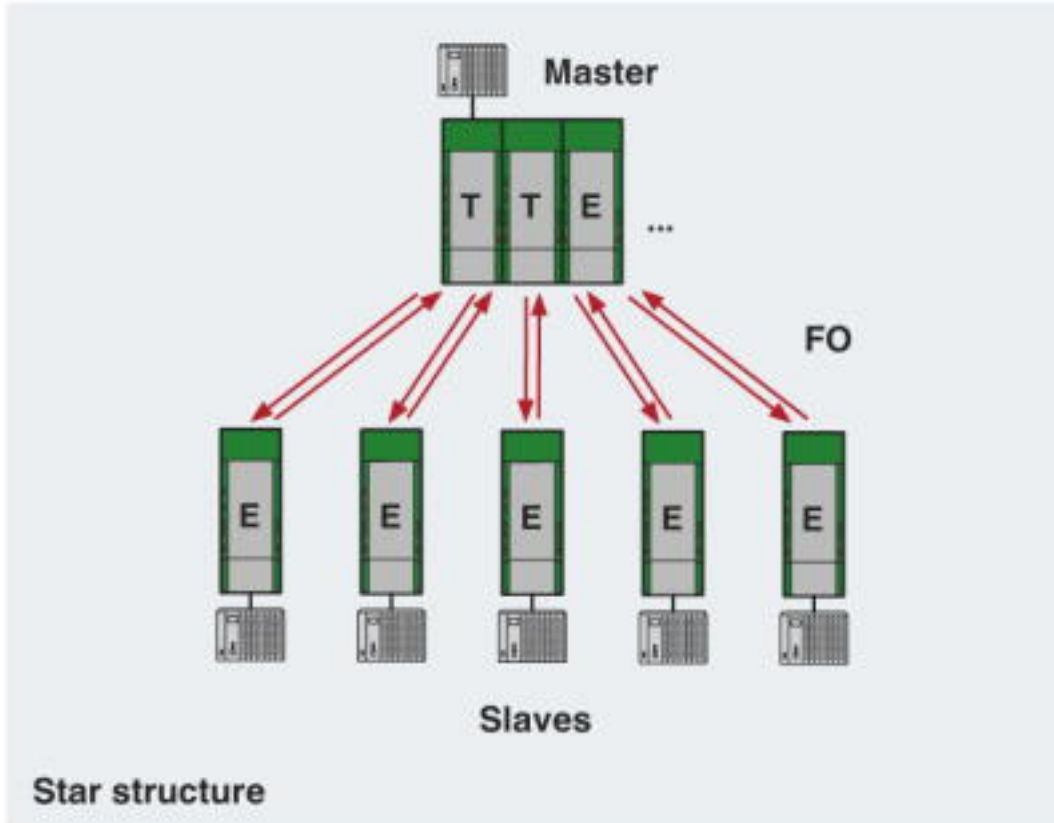

Star structure

# FO converters - PSI-MOS-RS232/FO 660 E - 2708368

Application drawing

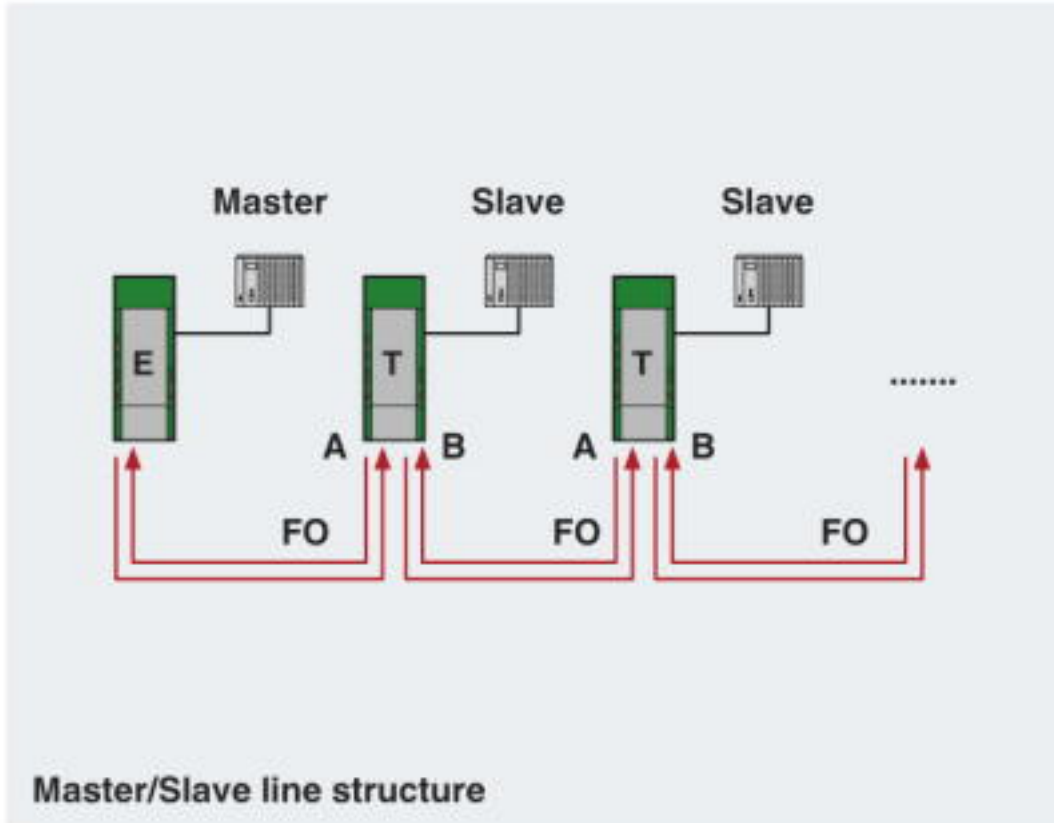

Master/Slave line structure

# FO converters - PSI-MOS-RS232/FO 660 E - 2708368

Application drawing

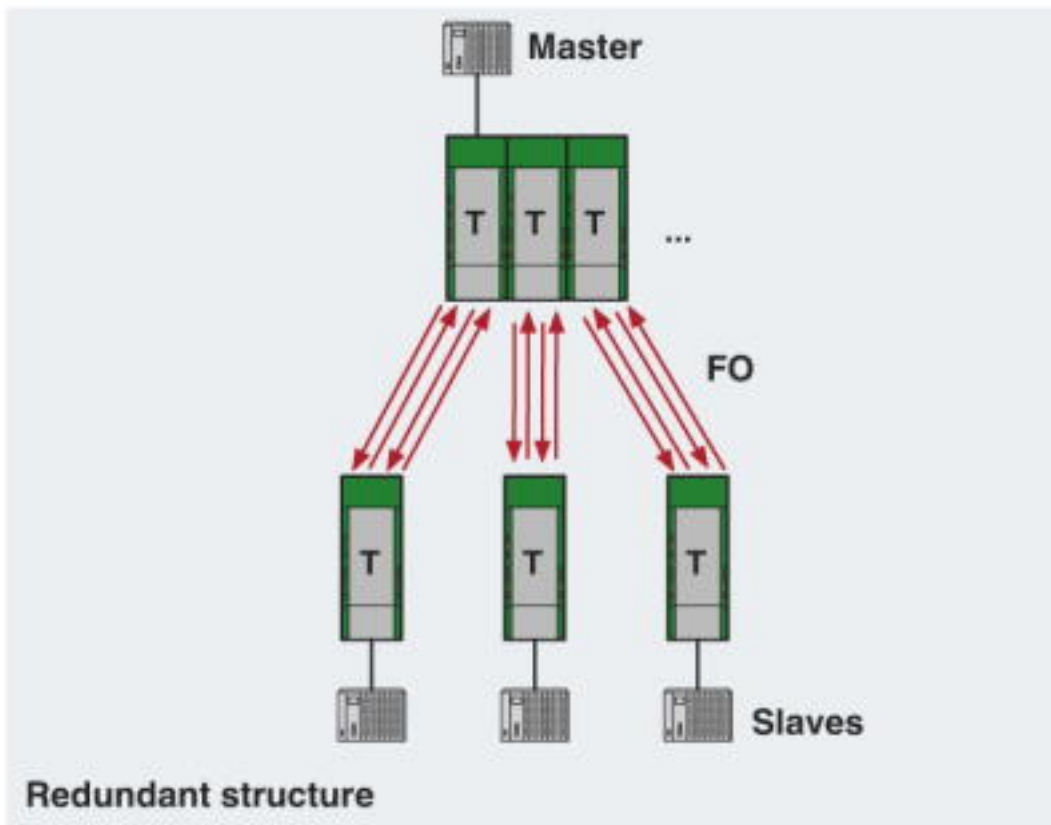

Redundant structure

## Classifications

eCl@ss

eCl@ss 4.0	27230200
eCl@ss 4.1	27230200
eCl@ss 5.0	27230200
eCl@ss 5.1	27230200
eCl@ss 6.0	19179200
eCl@ss 7.0	19179290
eCl@ss 8.0	19179290
eCl@ss 9.0	19170114

ETIM

ETIM 2.0	EC001423
ETIM 3.0	EC001423
ETIM 4.0	EC001423
ETIM 5.0	EC000310
ETIM 6.0	EC001467



# FO converters - PSI-MOS-RS232/FO 660 E - 2708368

## Classifications

### ETIM

ETIM 7.0	EC001467
----------	----------

### UNSPSC

UNSPSC 6.01	30211506
UNSPSC 7.0901	39121008
UNSPSC 11	39121008
UNSPSC 12.01	39121008
UNSPSC 13.2	43222604
UNSPSC 18.0	43223323
UNSPSC 19.0	43223323
UNSPSC 20.0	43223323
UNSPSC 21.0	43223323

## Approvals

### Approvals

---

Approvals

DNV GL / UL Recognized / cUL Recognized / EAC / KC / EAC / cULus Recognized

---

### Ex Approvals

UL Listed / cUL Listed / cULus Listed

---

### Approval details

DNV GL		<a href="https://approvalfinder.dnvgl.com/">https://approvalfinder.dnvgl.com/</a>	TAA00001KR
--------	---	---	------------

UL Recognized		<a href="http://database.ul.com/cgi-bin/XYV/template/LISEXT/1FRAME/index.htm">http://database.ul.com/cgi-bin/XYV/template/LISEXT/1FRAME/index.htm</a>	FILE E 238705
---------------	---	---	---------------

cUL Recognized		<a href="http://database.ul.com/cgi-bin/XYV/template/LISEXT/1FRAME/index.htm">http://database.ul.com/cgi-bin/XYV/template/LISEXT/1FRAME/index.htm</a>	FILE E 238705
----------------	---	---	---------------

EAC			EAC-Zulassung
-----	---	--	---------------

## FO converters - PSI-MOS-RS232/FO 660 E - 2708368

### Approvals

KC		<a href="http://eng.kcc.go.kr/user/ehpMain.do">http://eng.kcc.go.kr/user/ehpMain.do</a>	KCC-REI- PCK-FL270836
----	--	---	--------------------------

EAC			RU *- DE.A*30.B.01735
-----	--	--	--------------------------

cULus Recognized			
------------------	--	--	--

### Accessories

#### Accessories

#### Adapter cable

Data cable - PSM-KA9SUB9/BB/2METER - 2799474



RS-232 cable, 9-pos. D-SUB socket on 9-pos. D-SUB socket, 9-wire, 1:1

---

#### Data cable by the meter

FO cable - PSM-LWL-KDHEAVY-980/1000 - 2744319



Polymer fiber cable, duplex 980 µm/1000 µm, medium-weight version for installation in stationary systems and machines, by the meter without male connector

---

FO cable - PSM-LWL-RUGGED-980/1000 - 2744322



Polymer fiber cable, duplex 980µm/1000µm, heavy-weight version for installation in stationary systems and machines, by the meter without male connector

## FO converters - PSI-MOS-RS232/FO 660 E - 2708368

### Accessories

FO cable - PSM-LWL-RUGGED-FLEX-980/1000 - 2744335



Polymer fiber cable, duplex 980/1000  $\mu\text{m}$ , heavy-weight, highly flexible version for flexible conduit applications, by the meter, without connector

---

FO cable - PSM-LWL-HCS-RUGGED-200/230 - 2799885



PCF cable, duplex 200  $\mu\text{m}$ /230  $\mu\text{m}$ , by the meter without male connector, for installation in stationary systems and machines

---

FO cable - PSM-LWL-HCSO-200/230 - 2799445



PCF cable, duplex 200/230  $\mu\text{m}$ , by the meter, without connector, for outdoor installation

---

### Data cable preassembled

FO patch cable - FOC-RUGGED-1012/IP20/... - 2901548



Robust POF installation cable for assembly (IP20 heads only) for installation in stationary systems and machines with individual elements made of polyamide (PE), halogen-free, ozone and UV resistant, with reinforced polyurethane (PUR) outer sheath

---

FO patch cable - FOC-RUGGED-1012/... - 1402185



rugged POF installation cable for fixed installation in the inner area with individual elements made of highly durable polyamide (PE). Dimensioned for higher requirements in respect of tensile load and lateral pressure, with individual elements made of highly wear-resistant polyamide (PE). The cable is halogen-free, ozone and UV resistant and has a reinforced (PUR) outer sheath.

---

## FO converters - PSI-MOS-RS232/FO 660 E - 2708368

### Accessories

FO patch cable - FOC-RUGGED-FLEX-1013/IP20/... - 2901549



Highly flexible POF round cable (IP20 heads only) for use in drag chains. Individual elements made from extremely wear-resistant polyamide (PE). The cable is halogen-free, ozone and UV resistant, and has a rugged polyurethane (PUR) outer sheath.

---

FO patch cable - FOC-RUGGED-FLEX-1013/... - 1402187



Highly flexible POF round cable for use in drag chains for an alternating bending frequency of up to 5 million cycles with individual elements made of highly wear-resistant polyamide (PE). The cable is halogen-free, ozone and UV resistant and has a rugged polyurethane (PUR) outer sheath.

---

FO patch cable - FOC-KDHEAVY-1011/IP20/... - 2901553



POF installation cable for assembly (IP20 heads only) for installation in stationary systems and machines with individual elements made of polyamide (PE), halogen-free, ozone and UV resistant, with a polyurethane (PUR) outer sheath

---

FO patch cable - FOC-KDHEAVY-1011/... - 1402188



POF installation cable for fixed installation in the inner area with individual elements made of highly durable polyamide (PE). The cable is halogen-free, ozone and UV resistant and has a rugged polyurethane (PUR) outer sheath.

---

FO patch cable - FOC-HCS-RUGGED-1014/IP20/... - 2901555



Robust PCF installation cable for assembly (IP20 heads only) for installation in stationary systems and machines, aramid strain relief elements, with individual elements made from FRNC material, halogen-free, ozone and UV resistant, with a polyurethane (PUR) outer sheath

---

## FO converters - PSI-MOS-RS232/FO 660 E - 2708368

### Accessories

FO patch cable - FOC-HCS-RUGGED-1014/... - 1402191



rugged PCF installation cable for inner areas with highly tear-proof aramid strain-relief elements. Individual elements made from highly flexible FRNC material. The cable is halogen-free, ozone and UV resistant and has a rugged polyurethane (PUR) outer sheath.

FO patch cable - FOC-HCSO-1015/IP20/... - 2901557



Highly rugged PCF round cable (IP20 heads only) for assembly and for outdoor installation with integrated moisture barrier as well as rodent-proof scrim. Individual elements made from highly flexible FRNC material. The wire is ozone and UV resistant with a very rugged polyethylene outer sheath.

### Data plug

D-SUB bus connector - SUBCON-PLUS 9/F - 2744241



D-SUB connector, 9-pos. female connector, two cable entries <math>35^\circ</math>, universal type for all systems, pin assignment: 1, 2, 3, 4, 5, 6, 7, 8, 9 to one screw connection terminal block

D-SUB bus connector - SUBCON-PLUS 9/M - 2744018



D-SUB connector, 9-pos., male connector, two cable entries <math>35^\circ</math>, universal type for all systems, pin assignment: 1, 2, 3, 4, 5, 6, 7, 8, 9 to one screw connection terminal block

### DIN rail connector

DIN rail bus connectors - ME 17,5 TBUS 1,5/ 5-ST-3,81 GN - 2709561



DIN rail connector for DIN rail mounting. Universal for TBUS housing. Gold-plated contacts, 5-pos.

### Interface converter

## FO converters - PSI-MOS-RS232/FO 660 E - 2708368

### Accessories

Interface converter - PSM-ME-RS232/RS485-P - 2744416



Interface converter, for converting RS-232 (V.24) to RS-422 (V.11) and RS-485, with electrical isolation, 2 channels, rail-mountable

---

### Power supply

Power supply unit - MINI-SYS-PS-100-240AC/24DC/1.5 - 2866983



Primary-switched MINI POWER supply for DIN rail mounting, input: 1-phase, output: 24 V DC/1.5 A

---

### Screwdriver tools

Screwdriver - SZS 0,4X2,5 VDE - 1205037



Screwdriver, slot-headed, VDE insulated, size: 0.4 x 2.5 x 80 mm, 2-component grip, with non-slip grip

---

FO connectors - PSM-SET-FSMA/4-KT - 2799720



F-SMA plug set for polymer fiber, for self assembly consisting of 4 quick mounting connectors with bend protection sleeve

---

FO connectors - PSM-SET-FSMA/4-HCS - 2799487



F-SMA plug set for PCF fiber, for self assembly consisting of 4 quick mounting connectors with bend protection sleeve

---

DIN rail bus connectors - ME 17,5 TBUS 1,5/PP000-3,81 BK - 2890014

DIN rail connector for DIN rail mounting. Universal for TBUS housing. Gold-plated contacts, 2-pos.

## FO converters - PSI-MOS-RS232/FO 660 E - 2708368

### Accessories

---

#### Assembly tool - PSM-POF-KONFTOOL - 2744131



Polymer fiber DIY case, consisting of: Stripping knife, stripping pliers, polishing wheels for F-SMA and SC-RJ quick mounting connectors, polishing pad and emery paper

---

#### Assembly tool - PSM-HCS-KONFTOOL - 2799526



PCF assembly kit for F-SMA quick mounting connectors, including stripping blade, stripping pliers, aramide yarn scissors, fiber stripper, microscope, fiber cleaving tool for standard HCS fibers, four F-SMA connectors for standard PCF fibers, and documentation

---

#### Assembly tool - PSM-SET-FSMA-POLISH - 2799348



Polymer fiber polishing set, for F-SMA quick mounting connectors

---

#### Measuring instrument - PSM-FO-POWERMETER - 2799539



Fiber optic measuring case, consisting of an optical power meter, F-SMA, B-FOC adapters, reference fibers and operating instructions

---

#### Fiber optic coupling - PSM-SET-FSMA-LINK/2 - 2799416



Coupling; set consisting of 2 couplings for connecting F-SMA plugs

---

---

Phoenix Contact 2020 © - all rights reserved  
<http://www.phoenixcontact.com>

PHOENIX CONTACT GmbH & Co. KG  
Flachsmarktstr. 8  
32825 Blomberg  
Germany  
Tel. +49 5235 300  
Fax +49 5235 3 41200  
<http://www.phoenixcontact.com>