

## Feed-through terminal block - ZFKK 1,5-MSTBV-5,08 - 1873016

Please be informed that the data shown in this PDF Document is generated from our Online Catalog. Please find the complete data in the user's documentation. Our General Terms of Use for Downloads are valid (<http://phoenixcontact.com/download>)



Feed-through terminal block, connection method: Spring-cage connection, Plug connection, cross section: 0.2 mm<sup>2</sup> - 2.5 mm<sup>2</sup>, AWG: 24 - 16, width: 5.08 mm, color: gray, mounting: NS 35/7,5, NS 35/15



### Key Commercial Data

Packing unit	50 pc
GTIN	 4 017918 142407
GTIN	4017918142407

### Technical data

#### Environmental Product Compliance

China RoHS	Environmentally friendly use period: unlimited = EFUP-e
	No hazardous substances above threshold values

### Drawings

# Feed-through terminal block - ZFKK 1,5-MSTBV-5,08 - 1873016

Dimensional drawing

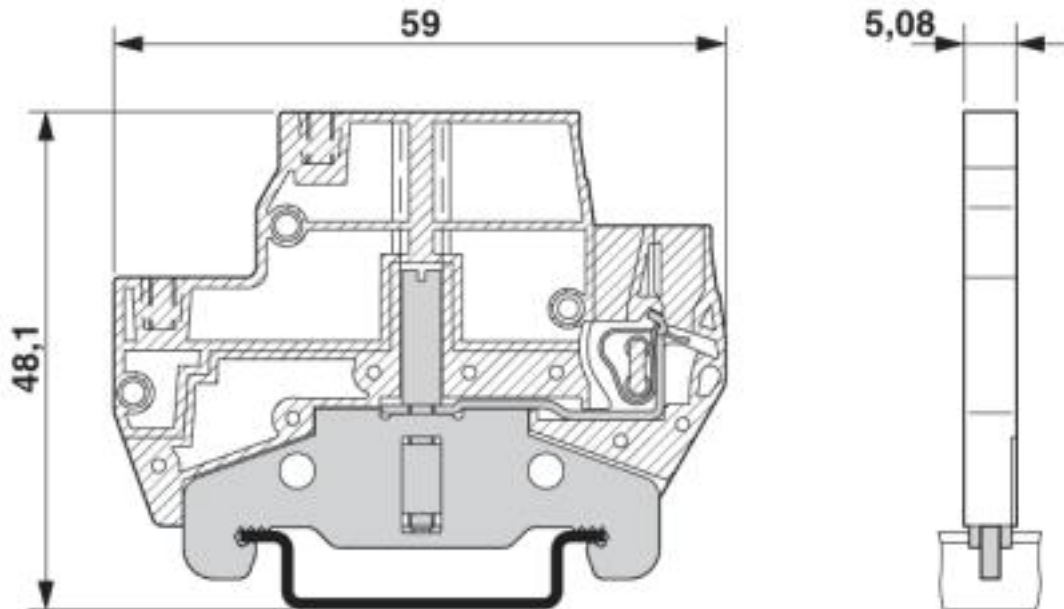

Circuit diagram

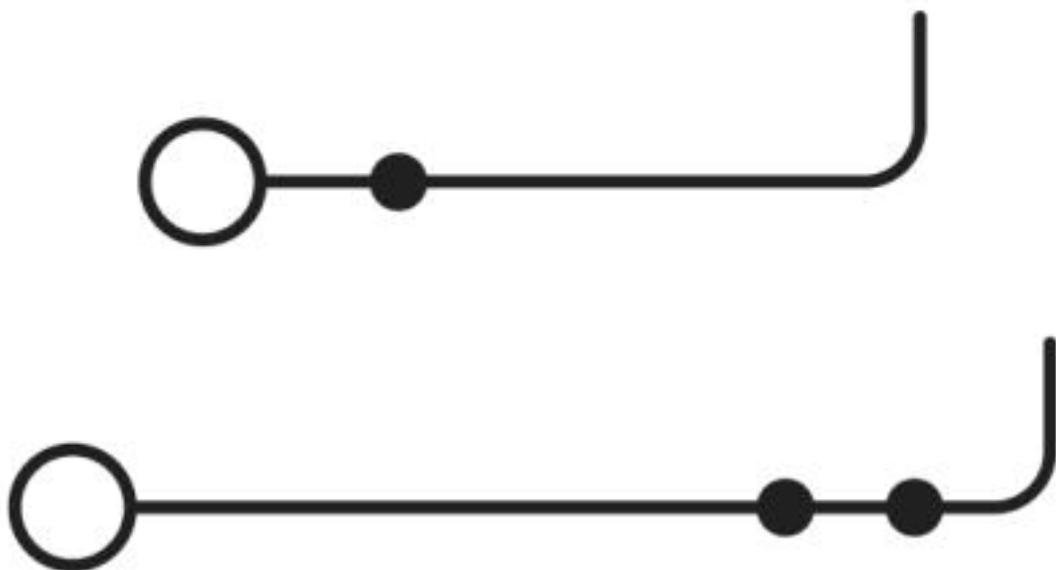

## Classifications

eCl@ss

eCl@ss 4.0	27141118
eCl@ss 4.1	27141118
eCl@ss 5.0	27141118
eCl@ss 5.1	27141100
eCl@ss 6.0	27141100

# Feed-through terminal block - ZFKK 1,5-MSTBV-5,08 - 1873016

## Classifications

### eCl@ss

eCl@ss 7.0	27141120
------------	----------

### ETIM

ETIM 2.0	EC000897
ETIM 3.0	EC000897
ETIM 4.0	EC000897
ETIM 6.0	EC000897
ETIM 7.0	EC000897

### UNSPSC

UNSPSC 6.01	30211811
UNSPSC 7.0901	39121410
UNSPSC 11	39121410
UNSPSC 12.01	39121410
UNSPSC 13.2	39121410
UNSPSC 19.0	39121410

## Accessories

### Accessories

#### Coding element

Coding section - CR-MSTB - 1734401

Coding section, inserted into the recess in the header or the inverted plug, red insulating material



---

### DIN rail

DIN rail perforated - NS 35/ 7,5 PERF 2000MM - 0801733



DIN rail perforated, Standard profile, width: 35 mm, height: 7.5 mm, acc. to EN 60715, material: Steel, galvanized, passivated with a thick layer, length: 2000 mm, color: silver

## Feed-through terminal block - ZFKK 1,5-MSTBV-5,08 - 1873016

### Accessories

DIN rail, unperforated - NS 35/ 7,5 UNPERF 2000MM - 0801681



DIN rail, unperforated, Standard profile, width: 35 mm, height: 7.5 mm, acc. to EN 60715, material: Steel, galvanized, passivated with a thick layer, length: 2000 mm, color: silver

---

DIN rail perforated - NS 35/ 7,5 WH PERF 2000MM - 1204119



DIN rail perforated, Standard profile, width: 35 mm, height: 7.5 mm, acc. to EN 60715, material: Steel, Galvanized, white passivated, length: 2000 mm, color: silver

---

DIN rail, unperforated - NS 35/ 7,5 WH UNPERF 2000MM - 1204122



DIN rail, unperforated, Standard profile, width: 35 mm, height: 7.5 mm, acc. to EN 60715, material: Steel, Galvanized, white passivated, length: 2000 mm, color: silver

---

DIN rail, unperforated - NS 35/ 7,5 AL UNPERF 2000MM - 0801704



DIN rail, unperforated, Standard profile, width: 35 mm, height: 7.5 mm, acc. to EN 60715, material: Aluminum, uncoated, length: 2000 mm, color: silver

---

DIN rail perforated - NS 35/ 7,5 ZN PERF 2000MM - 1206421



DIN rail perforated, Standard profile, width: 35 mm, height: 7.5 mm, acc. to EN 60715, material: Steel, galvanized, length: 2000 mm, color: silver

---

## Feed-through terminal block - ZFKK 1,5-MSTBV-5,08 - 1873016

### Accessories

DIN rail, unperforated - NS 35/ 7,5 ZN UNPERF 2000MM - 1206434



DIN rail, unperforated, Standard profile, width: 35 mm, height: 7.5 mm, acc. to EN 60715, material: Steel, galvanized, length: 2000 mm, color: silver

---

DIN rail, unperforated - NS 35/ 7,5 CU UNPERF 2000MM - 0801762



DIN rail, unperforated, Standard profile, width: 35 mm, height: 7.5 mm, acc. to EN 60715, material: Copper, uncoated, length: 2000 mm, color: copper-colored

---

End cap - NS 35/ 7,5 CAP - 1206560



DIN rail end piece, for DIN rail NS 35/7.5

---

DIN rail perforated - NS 35/15 PERF 2000MM - 1201730



DIN rail perforated, Standard profile, width: 35 mm, height: 15 mm, similar to EN 60715, material: Steel, galvanized, passivated with a thick layer, length: 2000 mm, color: silver

---

DIN rail, unperforated - NS 35/15 UNPERF 2000MM - 1201714



DIN rail, unperforated, Standard profile, width: 35 mm, height: 15 mm, similar to EN 60715, material: Steel, galvanized, passivated with a thick layer, length: 2000 mm, color: silver

---

## Feed-through terminal block - ZFKK 1,5-MSTBV-5,08 - 1873016

### Accessories

DIN rail perforated - NS 35/15 WH PERF 2000MM - 0806602



DIN rail perforated, Standard profile, width: 35 mm, height: 15 mm, similar to EN 60715, material: Steel, Galvanized, white passivated, length: 2000 mm, color: silver

---

DIN rail, unperforated - NS 35/15 WH UNPERF 2000MM - 1204135



DIN rail, unperforated, Standard profile, width: 35 mm, height: 15 mm, similar to EN 60715, material: Steel, Galvanized, white passivated, length: 2000 mm, color: silver

---

DIN rail, unperforated - NS 35/15 AL UNPERF 2000MM - 1201756



DIN rail, unperforated, Standard profile, width: 35 mm, height: 15 mm, similar to EN 60715, material: Aluminum, uncoated, length: 2000 mm, color: silver

---

DIN rail perforated - NS 35/15 ZN PERF 2000MM - 1206599



DIN rail perforated, Standard profile, width: 35 mm, height: 15 mm, similar to EN 60715, material: Steel, galvanized, length: 2000 mm, color: silver

---

DIN rail, unperforated - NS 35/15 ZN UNPERF 2000MM - 1206586



DIN rail, unperforated, Standard profile, width: 35 mm, height: 15 mm, similar to EN 60715, material: Steel, galvanized, length: 2000 mm, color: silver

---

## Feed-through terminal block - ZFKK 1,5-MSTBV-5,08 - 1873016

### Accessories

DIN rail, unperforated - NS 35/15 CU UNPERF 2000MM - 1201895



DIN rail, unperforated, Standard profile, width: 35 mm, height: 15 mm, similar to EN 60715, material: Copper, uncoated, length: 2000 mm, color: copper-colored

---

End cap - NS 35/15 CAP - 1206573



DIN rail end piece, for DIN rail NS 35/15

---

DIN rail, unperforated - NS 35/15-2,3 UNPERF 2000MM - 1201798



DIN rail, unperforated, Standard profile 2.3 mm, width: 35 mm, height: 15 mm, acc. to EN 60715, material: Steel, galvanized, passivated with a thick layer, length: 2000 mm, color: silver

---

End block

End clamp - CLIPFIX 35 - 3022218



Quick mounting end clamp for NS 35/7,5 DIN rail or NS 35/15 DIN rail, with marking option, width: 9.5 mm, color: gray

---

End clamp - CLIPFIX 35-5 - 3022276



Quick mounting end clamp for NS 35/7,5 DIN rail or NS 35/15 DIN rail, with marking option, with parking option for FBS...5, FBS...6, KSS 5, KSS 6, width: 5.15 mm, color: gray

---

## Feed-through terminal block - ZFKK 1,5-MSTBV-5,08 - 1873016

### Accessories

End clamp - E/NS 35 N - 0800886



End clamp, width: 9.5 mm, color: gray

---

End clamp - E/UK - 1201442



End clamp, width: 9.5 mm, height: 35.3 mm, material: PA, length: 50.5 mm, Mounting on a DIN rail NS 32 or NS 35, color: gray

---

End clamp - E/UK 1 - 1201413



End clamps, for supporting the ends of double-level and three-level terminal blocks, width: 10 mm, color: gray

---

End cover

End cover - D-ZFKK 1,5-MSTBV-5,08 - 1876945



End cover, pitch: 5.08 mm, length: 59 mm, width: 2 mm, height: 40 mm, number of positions: 1, color: gray

---

Jumper

Plug-in bridge - FBST 10-5 - 3025147



Plug-in bridge, pitch: 5.2 mm, number of positions: 10, color: gray

---



## Feed-through terminal block - ZFKK 1,5-MSTBV-5,08 - 1873016

### Accessories

Plug-in bridge - FBST 3-5 - 3025079



Plug-in bridge, pitch: 5.2 mm, number of positions: 3, color: gray

---

Plug-in bridge - FBST 2-5 - 3025066



Plug-in bridge, pitch: 5.2 mm, number of positions: 2, color: gray

---

### Labeled terminal marker

Marker card - SK 3,8 REEL P5,08 WH CUS - 0825125



Marker card, Card, can be ordered: By card, white, labeled according to customer specifications, mounting type: adhesive, for terminal block width: 5.08 mm, lettering field size: continuous x 3.8 mm

---

### Marker carriers

Marker carriers - STP 5-2/S - 0800970



Double marker carrier, snaps onto the double-level spring-cage terminal block ZFKK 1,5, with MSTBV or ICV pick-off

---

### Screw bridge

Fixed bridge - FBRI 20-5 N - 3000515



Fixed bridge, pitch: 5 mm, number of positions: 20, color: silver

---

## Feed-through terminal block - ZFKK 1,5-MSTBV-5,08 - 1873016

### Accessories

Fixed bridge - FBRI 16-5 N - 3000476



Fixed bridge, number of positions: 16, color: silver

---

Fixed bridge - FBRI 12-5 N - 3000434



Fixed bridge, number of positions: 12, color: silver

---

Fixed bridge - FBRI 2-5 N - 3000227



Fixed bridge, pitch: 5 mm, number of positions: 2, color: silver

---

Fixed bridge - FBRI 3-5 N - 3000201



Fixed bridge, pitch: 5 mm, number of positions: 3, color: silver

---

Fixed bridge - FBRI 10-5 N - 2770642



Fixed bridge, pitch: 5.2 mm, number of positions: 10, color: silver

---

## Feed-through terminal block - ZFKK 1,5-MSTBV-5,08 - 1873016

### Accessories

Fixed bridge - FBRI 40-5 N - 3006823



Fixed bridge, number of positions: 40, color: silver

---

### Additional products

Printed-circuit board connector - MVSTBR 2,5/ 9-ST-5,08 - 1792317



PCB connector, nominal current: 12 A, rated voltage (III/2): 320 V, nominal cross section: 2.5 mm<sup>2</sup>, number of positions: 9, pitch: 5.08 mm, connection method: Screw connection with tension sleeve, color: green, contact surface: Tin

---

Printed-circuit board connector - MVSTBR 2,5/11-ST-5,08 - 1792333



PCB connector, nominal current: 12 A, rated voltage (III/2): 320 V, nominal cross section: 2.5 mm<sup>2</sup>, number of positions: 11, pitch: 5.08 mm, connection method: Screw connection with tension sleeve, color: green, contact surface: Tin

---

Printed-circuit board connector - MVSTBR 2,5/14-ST-5,08 - 1792362



PCB connector, nominal current: 12 A, rated voltage (III/2): 320 V, nominal cross section: 2.5 mm<sup>2</sup>, number of positions: 14, pitch: 5.08 mm, connection method: Screw connection with tension sleeve, color: green, contact surface: Tin

---

Printed-circuit board connector - MVSTBR 2,5/16-ST-5,08 - 1792388



PCB connector, nominal current: 12 A, rated voltage (III/2): 320 V, nominal cross section: 2.5 mm<sup>2</sup>, number of positions: 16, pitch: 5.08 mm, connection method: Screw connection with tension sleeve, color: green, contact surface: Tin

## Feed-through terminal block - ZFKK 1,5-MSTBV-5,08 - 1873016

### Accessories

#### Printed-circuit board connector - MVSTBR 2,5/21-ST-5,08 - 1792430



PCB connector, nominal current: 12 A, rated voltage (III/2): 320 V, nominal cross section: 2.5 mm<sup>2</sup>, number of positions: 21, pitch: 5.08 mm, connection method: Screw connection with tension sleeve, color: green, contact surface: Tin

---

#### Printed-circuit board connector - MVSTBR 2,5/22-ST-5,08 - 1792443



PCB connector, nominal current: 12 A, rated voltage (III/2): 320 V, nominal cross section: 2.5 mm<sup>2</sup>, number of positions: 22, pitch: 5.08 mm, connection method: Screw connection with tension sleeve, color: green, contact surface: Tin

---

#### Printed-circuit board connector - MVSTBR 2,5/23-ST-5,08 - 1792456



PCB connector, nominal current: 12 A, rated voltage (III/2): 320 V, nominal cross section: 2.5 mm<sup>2</sup>, number of positions: 23, pitch: 5.08 mm, connection method: Screw connection with tension sleeve, color: green, contact surface: Tin

---

#### Printed-circuit board connector - MVSTBR 2,5/12-ST-5,08 - 1792346



PCB connector, nominal current: 12 A, rated voltage (III/2): 320 V, nominal cross section: 2.5 mm<sup>2</sup>, number of positions: 12, pitch: 5.08 mm, connection method: Screw connection with tension sleeve, color: green, contact surface: Tin

---

#### Printed-circuit board connector - MVSTBR 2,5/24-ST-5,08 - 1792469



PCB connector, nominal current: 12 A, rated voltage (III/2): 320 V, nominal cross section: 2.5 mm<sup>2</sup>, number of positions: 24, pitch: 5.08 mm, connection method: Screw connection with tension sleeve, color: green, contact surface: Tin

## Feed-through terminal block - ZFKK 1,5-MSTBV-5,08 - 1873016

### Accessories

#### Printed-circuit board connector - MVSTBR 2,5/10-ST-5,08 - 1792320



PCB connector, nominal current: 12 A, rated voltage (III/2): 320 V, nominal cross section: 2.5 mm<sup>2</sup>, number of positions: 10, pitch: 5.08 mm, connection method: Screw connection with tension sleeve, color: green, contact surface: Tin

---

#### Printed-circuit board connector - MVSTBR 2,5/15-ST-5,08 - 1792375



PCB connector, nominal current: 12 A, rated voltage (III/2): 320 V, nominal cross section: 2.5 mm<sup>2</sup>, number of positions: 15, pitch: 5.08 mm, connection method: Screw connection with tension sleeve, color: green, contact surface: Tin

---

#### Printed-circuit board connector - MVSTBR 2,5/ 2-ST-5,08 - 1792249



PCB connector, nominal current: 12 A, rated voltage (III/2): 320 V, nominal cross section: 2.5 mm<sup>2</sup>, number of positions: 2, pitch: 5.08 mm, connection method: Screw connection with tension sleeve, color: green, contact surface: Tin

---

#### Printed-circuit board connector - MVSTBR 2,5/ 6-ST-5,08 - 1792281



PCB connector, nominal current: 12 A, rated voltage (III/2): 320 V, nominal cross section: 2.5 mm<sup>2</sup>, number of positions: 6, pitch: 5.08 mm, connection method: Screw connection with tension sleeve, color: green, contact surface: Tin

---

#### Printed-circuit board connector - MVSTBR 2,5/13-ST-5,08 - 1792359



PCB connector, nominal current: 12 A, rated voltage (III/2): 320 V, nominal cross section: 2.5 mm<sup>2</sup>, number of positions: 13, pitch: 5.08 mm, connection method: Screw connection with tension sleeve, color: green, contact surface: Tin

## Feed-through terminal block - ZFKK 1,5-MSTBV-5,08 - 1873016

### Accessories

Printed-circuit board connector - MVSTBR 2,5/19-ST-5,08 - 1792414



PCB connector, nominal current: 12 A, rated voltage (III/2): 320 V, nominal cross section: 2.5 mm<sup>2</sup>, number of positions: 19, pitch: 5.08 mm, connection method: Screw connection with tension sleeve, color: green, contact surface: Tin

Printed-circuit board connector - FRONT-MSTB 2,5/ 2-ST-5,08 - 1777280



PCB connector, nominal current: 12 A, rated voltage (III/2): 320 V, nominal cross section: 2.5 mm<sup>2</sup>, number of positions: 2, pitch: 5.08 mm, connection method: Front screw connection, color: green, contact surface: Tin

Printed-circuit board connector - FRONT-MSTB 2,5/ 6-ST-5,08 - 1777329



PCB connector, nominal current: 12 A, rated voltage (III/2): 320 V, nominal cross section: 2.5 mm<sup>2</sup>, number of positions: 6, pitch: 5.08 mm, connection method: Front screw connection, color: green, contact surface: Tin

Printed-circuit board connector - FRONT-MSTB 2,5/ 7-ST-5,08 - 1777332



PCB connector, nominal current: 12 A, rated voltage (III/2): 320 V, nominal cross section: 2.5 mm<sup>2</sup>, number of positions: 7, pitch: 5.08 mm, connection method: Front screw connection, color: green, contact surface: Tin

Printed-circuit board connector - FRONT-MSTB 2,5/10-ST-5,08 - 1777361



PCB connector, nominal current: 12 A, rated voltage (III/2): 320 V, nominal cross section: 2.5 mm<sup>2</sup>, number of positions: 10, pitch: 5.08 mm, connection method: Front screw connection, color: green, contact surface: Tin

## Feed-through terminal block - ZFKK 1,5-MSTBV-5,08 - 1873016

### Accessories

Printed-circuit board connector - FRONT-MSTB 2,5/13-ST-5,08 - 1777390

PCB connector, nominal current: 12 A, rated voltage (III/2): 320 V, nominal cross section: 2.5 mm<sup>2</sup>, number of positions: 13, pitch: 5.08 mm, connection method: Front screw connection, color: green, contact surface: Tin



Printed-circuit board connector - FRONT-MSTB 2,5/11-ST-5,08 - 1777374

PCB connector, nominal current: 12 A, rated voltage (III/2): 320 V, nominal cross section: 2.5 mm<sup>2</sup>, number of positions: 11, pitch: 5.08 mm, connection method: Front screw connection, color: green, contact surface: Tin



Printed-circuit board connector - FRONT-MSTB 2,5/ 3-ST-5,08 - 1777293

PCB connector, nominal current: 12 A, rated voltage (III/2): 320 V, nominal cross section: 2.5 mm<sup>2</sup>, number of positions: 3, pitch: 5.08 mm, connection method: Front screw connection, color: green, contact surface: Tin



Printed-circuit board connector - FRONT-MSTB 2,5/19-ST-5,08 - 1777455

PCB connector, nominal current: 12 A, rated voltage (III/2): 320 V, nominal cross section: 2.5 mm<sup>2</sup>, number of positions: 19, pitch: 5.08 mm, connection method: Front screw connection, color: green, contact surface: Tin



Printed-circuit board connector - FRONT-MSTB 2,5/21-ST-5,08 - 1777471

PCB connector, nominal current: 12 A, rated voltage (III/2): 320 V, nominal cross section: 2.5 mm<sup>2</sup>, number of positions: 21, pitch: 5.08 mm, connection method: Front screw connection, color: green, contact surface: Tin



## Feed-through terminal block - ZFKK 1,5-MSTBV-5,08 - 1873016

### Accessories

#### Printed-circuit board connector - FRONT-MSTB 2,5/ 4-ST-5,08 - 1777303

PCB connector, nominal current: 12 A, rated voltage (III/2): 320 V, nominal cross section: 2.5 mm<sup>2</sup>, number of positions: 4, pitch: 5.08 mm, connection method: Front screw connection, color: green, contact surface: Tin



#### Printed-circuit board connector - FRONT-MSTB 2,5/ 5-ST-5,08 - 1777316

PCB connector, nominal current: 12 A, rated voltage (III/2): 320 V, nominal cross section: 2.5 mm<sup>2</sup>, number of positions: 5, pitch: 5.08 mm, connection method: Front screw connection, color: green, contact surface: Tin



#### Printed-circuit board connector - FRONT-MSTB 2,5/ 9-ST-5,08 - 1777358

PCB connector, nominal current: 12 A, rated voltage (III/2): 320 V, nominal cross section: 2.5 mm<sup>2</sup>, number of positions: 9, pitch: 5.08 mm, connection method: Front screw connection, color: green, contact surface: Tin



#### Printed-circuit board connector - FRONT-MSTB 2,5/12-ST-5,08 - 1777387

PCB connector, nominal current: 12 A, rated voltage (III/2): 320 V, nominal cross section: 2.5 mm<sup>2</sup>, number of positions: 12, pitch: 5.08 mm, connection method: Front screw connection, color: green, contact surface: Tin



#### Printed-circuit board connector - FRONT-MSTB 2,5/20-ST-5,08 - 1777468

PCB connector, nominal current: 12 A, rated voltage (III/2): 320 V, nominal cross section: 2.5 mm<sup>2</sup>, number of positions: 20, pitch: 5.08 mm, connection method: Front screw connection, color: green, contact surface: Tin





## Feed-through terminal block - ZFKK 1,5-MSTBV-5,08 - 1873016

### Accessories

Printed-circuit board connector - FRONT-MSTB 2,5/23-ST-5,08 - 1777497

PCB connector, nominal current: 12 A, rated voltage (III/2): 320 V, nominal cross section: 2.5 mm<sup>2</sup>, number of positions: 23, pitch: 5.08 mm, connection method: Front screw connection, color: green, contact surface: Tin



Printed-circuit board connector - FRONT-MSTB 2,5/ 8-STF-5,08 - 1777798

PCB connector, nominal current: 12 A, rated voltage (III/2): 320 V, nominal cross section: 2.5 mm<sup>2</sup>, number of positions: 8, pitch: 5.08 mm, connection method: Front screw connection, color: green, contact surface: Tin



Printed-circuit board connector - FRONT-MSTB 2,5/ 5-STF-5,08 - 1777837

PCB connector, nominal current: 12 A, rated voltage (III/2): 320 V, nominal cross section: 2.5 mm<sup>2</sup>, number of positions: 5, pitch: 5.08 mm, connection method: Front screw connection, color: green, contact surface: Tin



Printed-circuit board connector - FRONT-MSTB 2,5/ 9-STF-5,08 - 1777866

PCB connector, nominal current: 12 A, rated voltage (III/2): 320 V, nominal cross section: 2.5 mm<sup>2</sup>, number of positions: 9, pitch: 5.08 mm, connection method: Front screw connection, color: green, contact surface: Tin



Printed-circuit board connector - FRONT-MSTB 2,5/11-STF-5,08 - 1777882

PCB connector, nominal current: 12 A, rated voltage (III/2): 320 V, nominal cross section: 2.5 mm<sup>2</sup>, number of positions: 11, pitch: 5.08 mm, connection method: Front screw connection, color: green, contact surface: Tin



## Feed-through terminal block - ZFKK 1,5-MSTBV-5,08 - 1873016

### Accessories

Printed-circuit board connector - FRONT-MSTB 2,5/12-STF-5,08 - 1777895

PCB connector, nominal current: 12 A, rated voltage (III/2): 320 V, nominal cross section: 2.5 mm<sup>2</sup>, number of positions: 12, pitch: 5.08 mm, connection method: Front screw connection, color: green, contact surface: Tin



Printed-circuit board connector - FRONT-MSTB 2,5/16-STF-5,08 - 1777934

PCB connector, nominal current: 12 A, rated voltage (III/2): 320 V, nominal cross section: 2.5 mm<sup>2</sup>, number of positions: 16, pitch: 5.08 mm, connection method: Front screw connection, color: green, contact surface: Tin



Printed-circuit board connector - FRONT-MSTB 2,5/20-STF-5,08 - 1777976

PCB connector, nominal current: 12 A, rated voltage (III/2): 320 V, nominal cross section: 2.5 mm<sup>2</sup>, number of positions: 20, pitch: 5.08 mm, connection method: Front screw connection, color: green, contact surface: Tin



Printed-circuit board connector - FRONT-MSTB 2,5/ 3-STF-5,08 - 1777811

PCB connector, nominal current: 12 A, rated voltage (III/2): 320 V, nominal cross section: 2.5 mm<sup>2</sup>, number of positions: 3, pitch: 5.08 mm, connection method: Front screw connection, color: green, contact surface: Tin



Printed-circuit board connector - FRONT-MSTB 2,5/18-STF-5,08 - 1777950

PCB connector, nominal current: 12 A, rated voltage (III/2): 320 V, nominal cross section: 2.5 mm<sup>2</sup>, number of positions: 18, pitch: 5.08 mm, connection method: Front screw connection, color: green, contact surface: Tin



## Feed-through terminal block - ZFKK 1,5-MSTBV-5,08 - 1873016

### Accessories

Printed-circuit board connector - FRONT-MSTB 2,5/19-STF-5,08 - 1777963

PCB connector, nominal current: 12 A, rated voltage (III/2): 320 V, nominal cross section: 2.5 mm<sup>2</sup>, number of positions: 19, pitch: 5.08 mm, connection method: Front screw connection, color: green, contact surface: Tin



Printed-circuit board connector - FRONT-MSTB 2,5/17-STF-5,08 - 1777947

PCB connector, nominal current: 12 A, rated voltage (III/2): 320 V, nominal cross section: 2.5 mm<sup>2</sup>, number of positions: 17, pitch: 5.08 mm, connection method: Front screw connection, color: green, contact surface: Tin



Printed-circuit board connector - FRONT-MSTB 2,5/14-STF-5,08 - 1777918

PCB connector, nominal current: 12 A, rated voltage (III/2): 320 V, nominal cross section: 2.5 mm<sup>2</sup>, number of positions: 14, pitch: 5.08 mm, connection method: Front screw connection, color: green, contact surface: Tin



Printed-circuit board connector - FRONT-MSTB 2,5/10-STF-5,08 - 1777879

PCB connector, nominal current: 12 A, rated voltage (III/2): 320 V, nominal cross section: 2.5 mm<sup>2</sup>, number of positions: 10, pitch: 5.08 mm, connection method: Front screw connection, color: green, contact surface: Tin



Printed-circuit board connector - FRONT-MSTB 2,5/15-STF-5,08 - 1777921

PCB connector, nominal current: 12 A, rated voltage (III/2): 320 V, nominal cross section: 2.5 mm<sup>2</sup>, number of positions: 15, pitch: 5.08 mm, connection method: Front screw connection, color: green, contact surface: Tin



## Feed-through terminal block - ZFKK 1,5-MSTBV-5,08 - 1873016

### Accessories

#### Printed-circuit board connector - FRONT-MSTB 2,5/ 2-STF-5,08 - 1777808

PCB connector, nominal current: 12 A, rated voltage (III/2): 320 V, nominal cross section: 2.5 mm<sup>2</sup>, number of positions: 2, pitch: 5.08 mm, connection method: Front screw connection, color: green, contact surface: Tin



#### Printed-circuit board connector - FKC 2,5/ 4-ST-5,08 - 1873074

PCB connector, nominal current: 12 A, rated voltage (III/2): 320 V, nominal cross section: 2.5 mm<sup>2</sup>, number of positions: 4, pitch: 5.08 mm, connection method: Push-in spring connection, color: green, contact surface: Tin



#### Printed-circuit board connector - FKC 2,5/ 7-ST-5,08 - 1873100

PCB connector, nominal current: 12 A, rated voltage (III/2): 320 V, nominal cross section: 2.5 mm<sup>2</sup>, number of positions: 7, pitch: 5.08 mm, connection method: Push-in spring connection, color: green, contact surface: Tin



#### Printed-circuit board connector - FKC 2,5/ 8-ST-5,08 - 1873113

PCB connector, nominal current: 12 A, rated voltage (III/2): 320 V, nominal cross section: 2.5 mm<sup>2</sup>, number of positions: 8, pitch: 5.08 mm, connection method: Push-in spring connection, color: green, contact surface: Tin



#### Printed-circuit board connector - FKC 2,5/10-ST-5,08 - 1873139

PCB connector, nominal current: 12 A, rated voltage (III/2): 320 V, nominal cross section: 2.5 mm<sup>2</sup>, number of positions: 10, pitch: 5.08 mm, connection method: Push-in spring connection, color: green, contact surface: Tin



## Feed-through terminal block - ZFKK 1,5-MSTBV-5,08 - 1873016

### Accessories

#### Printed-circuit board connector - FKC 2,5/12-ST-5,08 - 1873155

PCB connector, nominal current: 12 A, rated voltage (III/2): 320 V, nominal cross section: 2.5 mm<sup>2</sup>, number of positions: 12, pitch: 5.08 mm, connection method: Push-in spring connection, color: green, contact surface: Tin



#### Printed-circuit board connector - FKC 2,5/16-ST-5,08 - 1873197

PCB connector, nominal current: 12 A, rated voltage (III/2): 320 V, nominal cross section: 2.5 mm<sup>2</sup>, number of positions: 16, pitch: 5.08 mm, connection method: Push-in spring connection, color: green, contact surface: Tin



#### Printed-circuit board connector - FKC 2,5/ 3-ST-5,08 - 1873061

PCB connector, nominal current: 12 A, rated voltage (III/2): 320 V, nominal cross section: 2.5 mm<sup>2</sup>, number of positions: 3, pitch: 5.08 mm, connection method: Push-in spring connection, color: green, contact surface: Tin



#### Printed-circuit board connector - FKC 2,5/ 9-ST-5,08 - 1873126

PCB connector, nominal current: 12 A, rated voltage (III/2): 320 V, nominal cross section: 2.5 mm<sup>2</sup>, number of positions: 9, pitch: 5.08 mm, connection method: Push-in spring connection, color: green, contact surface: Tin



#### Printed-circuit board connector - FKC 2,5/ 6-ST-5,08 - 1873090

PCB connector, nominal current: 12 A, rated voltage (III/2): 320 V, nominal cross section: 2.5 mm<sup>2</sup>, number of positions: 6, pitch: 5.08 mm, connection method: Push-in spring connection, color: green, contact surface: Tin



## Feed-through terminal block - ZFKK 1,5-MSTBV-5,08 - 1873016

### Accessories

#### Printed-circuit board connector - FKC 2,5/11-ST-5,08 - 1873142

PCB connector, nominal current: 12 A, rated voltage (III/2): 320 V, nominal cross section: 2.5 mm<sup>2</sup>, number of positions: 11, pitch: 5.08 mm, connection method: Push-in spring connection, color: green, contact surface: Tin



#### Printed-circuit board connector - FKC 2,5/15-ST-5,08 - 1873184

PCB connector, nominal current: 12 A, rated voltage (III/2): 320 V, nominal cross section: 2.5 mm<sup>2</sup>, number of positions: 15, pitch: 5.08 mm, connection method: Push-in spring connection, color: green, contact surface: Tin



#### Printed-circuit board connector - FKC 2,5/ 2-ST-5,08 - 1873058

PCB connector, nominal current: 12 A, rated voltage (III/2): 320 V, nominal cross section: 2.5 mm<sup>2</sup>, number of positions: 2, pitch: 5.08 mm, connection method: Push-in spring connection, color: green, contact surface: Tin



#### Printed-circuit board connector - FKCVR 2,5/ 3-ST-5,08 - 1873964

PCB connector, nominal current: 12 A, rated voltage (III/2): 320 V, nominal cross section: 2.5 mm<sup>2</sup>, number of positions: 3, pitch: 5.08 mm, connection method: Push-in spring connection, color: green, contact surface: Tin

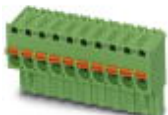

#### Printed-circuit board connector - FKCVR 2,5/ 5-ST-5,08 - 1873980

PCB connector, nominal current: 12 A, rated voltage (III/2): 320 V, nominal cross section: 2.5 mm<sup>2</sup>, number of positions: 5, pitch: 5.08 mm, connection method: Push-in spring connection, color: green, contact surface: Tin

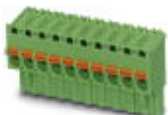

## Feed-through terminal block - ZFKK 1,5-MSTBV-5,08 - 1873016

### Accessories

#### Printed-circuit board connector - FKCVR 2,5/ 6-ST-5,08 - 1873993



PCB connector, nominal current: 12 A, rated voltage (III/2): 320 V, nominal cross section: 2.5 mm<sup>2</sup>, number of positions: 6, pitch: 5.08 mm, connection method: Push-in spring connection, color: green, contact surface: Tin

---

#### Printed-circuit board connector - FKCVR 2,5/ 8-ST-5,08 - 1874015



PCB connector, nominal current: 12 A, rated voltage (III/2): 320 V, nominal cross section: 2.5 mm<sup>2</sup>, number of positions: 8, pitch: 5.08 mm, connection method: Push-in spring connection, color: green, contact surface: Tin

---

#### Printed-circuit board connector - FKCVR 2,5/12-ST-5,08 - 1874057



PCB connector, nominal current: 12 A, rated voltage (III/2): 320 V, nominal cross section: 2.5 mm<sup>2</sup>, number of positions: 12, pitch: 5.08 mm, connection method: Push-in spring connection, color: green, contact surface: Tin

---

#### Printed-circuit board connector - FKCVR 2,5/13-ST-5,08 - 1874060



PCB connector, nominal current: 12 A, rated voltage (III/2): 320 V, nominal cross section: 2.5 mm<sup>2</sup>, number of positions: 13, pitch: 5.08 mm, connection method: Push-in spring connection, color: green, contact surface: Tin

---

#### Printed-circuit board connector - FKCVR 2,5/15-ST-5,08 - 1874086



PCB connector, nominal current: 12 A, rated voltage (III/2): 320 V, nominal cross section: 2.5 mm<sup>2</sup>, number of positions: 15, pitch: 5.08 mm, connection method: Push-in spring connection, color: green, contact surface: Tin

## Feed-through terminal block - ZFKK 1,5-MSTBV-5,08 - 1873016

### Accessories

#### Printed-circuit board connector - FKCVR 2,5/14-ST-5,08 - 1874073



PCB connector, nominal current: 12 A, rated voltage (III/2): 320 V, nominal cross section: 2.5 mm<sup>2</sup>, number of positions: 14, pitch: 5.08 mm, connection method: Push-in spring connection, color: green, contact surface: Tin

#### Printed-circuit board connector - FKCVR 2,5/10-ST-5,08 - 1874031



PCB connector, nominal current: 12 A, rated voltage (III/2): 320 V, nominal cross section: 2.5 mm<sup>2</sup>, number of positions: 10, pitch: 5.08 mm, connection method: Push-in spring connection, color: green, contact surface: Tin

#### Printed-circuit board connector - FKCVR 2,5/11-ST-5,08 - 1874044



PCB connector, nominal current: 12 A, rated voltage (III/2): 320 V, nominal cross section: 2.5 mm<sup>2</sup>, number of positions: 11, pitch: 5.08 mm, connection method: Push-in spring connection, color: green, contact surface: Tin

#### Printed-circuit board connector - FKCVR 2,5/ 7-ST-5,08 - 1874002



PCB connector, nominal current: 12 A, rated voltage (III/2): 320 V, nominal cross section: 2.5 mm<sup>2</sup>, number of positions: 7, pitch: 5.08 mm, connection method: Push-in spring connection, color: green, contact surface: Tin

#### Printed-circuit board connector - QC 1/ 2-ST-5,08 - 1883255



PCB connector, nominal current: 10 A, rated voltage (III/2): 630 V, nominal cross section: 1 mm<sup>2</sup>, number of positions: 2, pitch: 5.08 mm, connection method: Displacement connection, color: green, contact surface: Tin



## Feed-through terminal block - ZFKK 1,5-MSTBV-5,08 - 1873016

### Accessories

Printed-circuit board connector - QC 1/ 5-ST-5,08 - 1883284

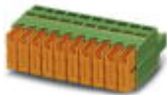

PCB connector, nominal current: 10 A, rated voltage (III/2): 630 V, nominal cross section: 1 mm<sup>2</sup>, number of positions: 5, pitch: 5.08 mm, connection method: Displacement connection, color: green, contact surface: Tin

Printed-circuit board connector - QC 1/ 6-ST-5,08 - 1883297

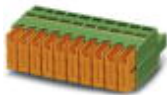

PCB connector, nominal current: 10 A, rated voltage (III/2): 630 V, nominal cross section: 1 mm<sup>2</sup>, number of positions: 6, pitch: 5.08 mm, connection method: Displacement connection, color: green, contact surface: Tin

Printed-circuit board connector - QC 1/ 8-ST-5,08 - 1883310



PCB connector, nominal current: 10 A, rated voltage (III/2): 630 V, nominal cross section: 1 mm<sup>2</sup>, number of positions: 8, pitch: 5.08 mm, connection method: Displacement connection, color: green, contact surface: Tin

Printed-circuit board connector - QC 1/15-ST-5,08 - 1883831

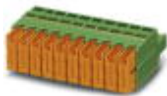

PCB connector, nominal current: 10 A, rated voltage (III/2): 630 V, nominal cross section: 1 mm<sup>2</sup>, number of positions: 15, pitch: 5.08 mm, connection method: Displacement connection, color: green, contact surface: Tin

Printed-circuit board connector - QC 1/16-ST-5,08 - 1883844



PCB connector, nominal current: 10 A, rated voltage (III/2): 630 V, nominal cross section: 1 mm<sup>2</sup>, number of positions: 16, pitch: 5.08 mm, connection method: Displacement connection, color: green, contact surface: Tin

## Feed-through terminal block - ZFKK 1,5-MSTBV-5,08 - 1873016

### Accessories

Printed-circuit board connector - QC 1/13-ST-5,08 - 1883815

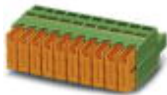

PCB connector, nominal current: 10 A, rated voltage (III/2): 630 V, nominal cross section: 1 mm<sup>2</sup>, number of positions: 13, pitch: 5.08 mm, connection method: Displacement connection, color: green, contact surface: Tin

---

Printed-circuit board connector - QC 1/14-ST-5,08 - 1883828



PCB connector, nominal current: 10 A, rated voltage (III/2): 630 V, nominal cross section: 1 mm<sup>2</sup>, number of positions: 14, pitch: 5.08 mm, connection method: Displacement connection, color: green, contact surface: Tin

---

Printed-circuit board connector - QC 1/ 9-ST-5,08 - 1883323



PCB connector, nominal current: 10 A, rated voltage (III/2): 630 V, nominal cross section: 1 mm<sup>2</sup>, number of positions: 9, pitch: 5.08 mm, connection method: Displacement connection, color: green, contact surface: Tin

---

Printed-circuit board connector - QC 1/11-ST-5,08 - 1883349

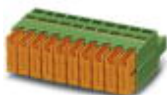

PCB connector, nominal current: 10 A, rated voltage (III/2): 630 V, nominal cross section: 1 mm<sup>2</sup>, number of positions: 11, pitch: 5.08 mm, connection method: Displacement connection, color: green, contact surface: Tin

---

Printed-circuit board connector - QC 1/ 7-ST-5,08 - 1883307

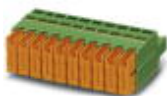

PCB connector, nominal current: 10 A, rated voltage (III/2): 630 V, nominal cross section: 1 mm<sup>2</sup>, number of positions: 7, pitch: 5.08 mm, connection method: Displacement connection, color: green, contact surface: Tin

---

## Feed-through terminal block - ZFKK 1,5-MSTBV-5,08 - 1873016

### Accessories

#### Printed-circuit board connector - MSTBC 2,5/13-ST-5,08 - 1808926

PCB connector, nominal current: 12 A, rated voltage (III/2): 320 V, nominal cross section: 2.5 mm<sup>2</sup>, number of positions: 13, pitch: 5.08 mm, connection method: Crimp connection, color: green, Corresponding female crimp contacts with current [A] and conductor cross section range [mm<sup>2</sup>] data: 10A/MSTBC-MT 0,5-1,0 (3190564); 10A/MSTBC-MT 0,5-1,0 BA (3190645); 12A/MSTBC-MT 1,5-2,5 (3190551); 12A/MSTBC-MT 1,5-2,5 BA (3190658). BA = Bandkontakte



#### Printed-circuit board connector - MSTBC 2,5/15-ST-5,08 - 1808942

PCB connector, nominal current: 12 A, rated voltage (III/2): 320 V, nominal cross section: 2.5 mm<sup>2</sup>, number of positions: 15, pitch: 5.08 mm, connection method: Crimp connection, color: green, Corresponding female crimp contacts with current [A] and conductor cross section range [mm<sup>2</sup>] data: 10A/MSTBC-MT 0,5-1,0 (3190564); 10A/MSTBC-MT 0,5-1,0 BA (3190645); 12A/MSTBC-MT 1,5-2,5 (3190551); 12A/MSTBC-MT 1,5-2,5 BA (3190658). BA = Bandkontakte



#### Printed-circuit board connector - MSTBC 2,5/19-ST-5,08 - 1808984

PCB connector, nominal current: 12 A, rated voltage (III/2): 320 V, nominal cross section: 2.5 mm<sup>2</sup>, number of positions: 19, pitch: 5.08 mm, connection method: Crimp connection, color: green, Corresponding female crimp contacts with current [A] and conductor cross section range [mm<sup>2</sup>] data: 10A/MSTBC-MT 0,5-1,0 (3190564); 10A/MSTBC-MT 0,5-1,0 BA (3190645); 12A/MSTBC-MT 1,5-2,5 (3190551); 12A/MSTBC-MT 1,5-2,5 BA (3190658). BA = Bandkontakte



#### Printed-circuit board connector - MSTBC 2,5/20-ST-5,08 - 1808997

PCB connector, nominal current: 12 A, rated voltage (III/2): 320 V, nominal cross section: 2.5 mm<sup>2</sup>, number of positions: 20, pitch: 5.08 mm, connection method: Crimp connection, color: green, Corresponding female crimp contacts with current [A] and conductor cross section range [mm<sup>2</sup>] data: 10A/MSTBC-MT 0,5-1,0 (3190564); 10A/MSTBC-MT 0,5-1,0 BA (3190645); 12A/MSTBC-MT 1,5-2,5 (3190551); 12A/MSTBC-MT 1,5-2,5 BA (3190658). BA = Bandkontakte



#### Printed-circuit board connector - MSTBC 2,5/18-ST-5,08 - 1808971

PCB connector, nominal current: 12 A, rated voltage (III/2): 320 V, nominal cross section: 2.5 mm<sup>2</sup>, number of positions: 18, pitch: 5.08 mm, connection method: Crimp connection, color: green, Corresponding female crimp contacts with current [A] and conductor cross section range [mm<sup>2</sup>] data: 10A/MSTBC-MT 0,5-1,0 (3190564); 10A/MSTBC-MT 0,5-1,0 BA (3190645); 12A/MSTBC-MT 1,5-2,5 (3190551); 12A/MSTBC-MT 1,5-2,5 BA (3190658). BA = Bandkontakte



## Feed-through terminal block - ZFKK 1,5-MSTBV-5,08 - 1873016

### Accessories

#### Printed-circuit board connector - MSTBC 2,5/ 3-ST-5,08 - 1808829

PCB connector, nominal current: 12 A, rated voltage (III/2): 320 V, nominal cross section: 2.5 mm<sup>2</sup>, number of positions: 3, pitch: 5.08 mm, connection method: Crimp connection, color: green, Corresponding female crimp contacts with current [A] and conductor cross section range [mm<sup>2</sup>] data: 10A/MSTBC-MT 0,5-1,0 (3190564); 10A/MSTBC-MT 0,5-1,0 BA (3190645); 12A/MSTBC-MT 1,5-2,5 (3190551); 12A/MSTBC-MT 1,5-2,5 BA (3190658). BA = Bandkontakte



#### Printed-circuit board connector - MSTBC 2,5/22-ST-5,08 - 1809019

PCB connector, nominal current: 12 A, rated voltage (III/2): 320 V, nominal cross section: 2.5 mm<sup>2</sup>, number of positions: 22, pitch: 5.08 mm, connection method: Crimp connection, color: green, Corresponding female crimp contacts with current [A] and conductor cross section range [mm<sup>2</sup>] data: 10A/MSTBC-MT 0,5-1,0 (3190564); 10A/MSTBC-MT 0,5-1,0 BA (3190645); 12A/MSTBC-MT 1,5-2,5 (3190551); 12A/MSTBC-MT 1,5-2,5 BA (3190658). BA = Bandkontakte



#### Printed-circuit board connector - MSTBC 2,5/ 7-ST-5,08 - 1808861

PCB connector, nominal current: 12 A, rated voltage (III/2): 320 V, nominal cross section: 2.5 mm<sup>2</sup>, number of positions: 7, pitch: 5.08 mm, connection method: Crimp connection, color: green, Corresponding female crimp contacts with current [A] and conductor cross section range [mm<sup>2</sup>] data: 10A/MSTBC-MT 0,5-1,0 (3190564); 10A/MSTBC-MT 0,5-1,0 BA (3190645); 12A/MSTBC-MT 1,5-2,5 (3190551); 12A/MSTBC-MT 1,5-2,5 BA (3190658). BA = Bandkontakte



#### Printed-circuit board connector - MSTBC 2,5/23-ST-5,08 - 1809022

PCB connector, nominal current: 12 A, rated voltage (III/2): 320 V, nominal cross section: 2.5 mm<sup>2</sup>, number of positions: 23, pitch: 5.08 mm, connection method: Crimp connection, color: green, Corresponding female crimp contacts with current [A] and conductor cross section range [mm<sup>2</sup>] data: 10A/MSTBC-MT 0,5-1,0 (3190564); 10A/MSTBC-MT 0,5-1,0 BA (3190645); 12A/MSTBC-MT 1,5-2,5 (3190551); 12A/MSTBC-MT 1,5-2,5 BA (3190658). BA = Bandkontakte



#### Printed-circuit board connector - MSTBC 2,5/10-ST-5,08 - 1808890

PCB connector, nominal current: 12 A, rated voltage (III/2): 320 V, nominal cross section: 2.5 mm<sup>2</sup>, number of positions: 10, pitch: 5.08 mm, connection method: Crimp connection, color: green, Corresponding female crimp contacts with current [A] and conductor cross section range [mm<sup>2</sup>] data: 10A/MSTBC-MT 0,5-1,0 (3190564); 10A/MSTBC-MT 0,5-1,0 BA (3190645); 12A/MSTBC-MT 1,5-2,5 (3190551); 12A/MSTBC-MT 1,5-2,5 BA (3190658). BA = Bandkontakte



## Feed-through terminal block - ZFKK 1,5-MSTBV-5,08 - 1873016

### Accessories

#### Printed-circuit board connector - MSTBC 2,5/ 2-ST-5,08 - 1808816

PCB connector, nominal current: 12 A, rated voltage (III/2): 320 V, nominal cross section: 2.5 mm<sup>2</sup>, number of positions: 2, pitch: 5.08 mm, connection method: Crimp connection, color: green, Corresponding female crimp contacts with current [A] and conductor cross section range [mm<sup>2</sup>] data: 10A/MSTBC-MT 0,5-1,0 (3190564); 10A/MSTBC-MT 0,5-1,0 BA (3190645); 12A/MSTBC-MT 1,5-2,5 (3190551); 12A/MSTBC-MT 1,5-2,5 BA (3190658). BA = Bandkontakte



#### Printed-circuit board connector - MSTBC 2,5/ 4-ST-5,08 - 1808832

PCB connector, nominal current: 12 A, rated voltage (III/2): 320 V, nominal cross section: 2.5 mm<sup>2</sup>, number of positions: 4, pitch: 5.08 mm, connection method: Crimp connection, color: green, Corresponding female crimp contacts with current [A] and conductor cross section range [mm<sup>2</sup>] data: 10A/MSTBC-MT 0,5-1,0 (3190564); 10A/MSTBC-MT 0,5-1,0 BA (3190645); 12A/MSTBC-MT 1,5-2,5 (3190551); 12A/MSTBC-MT 1,5-2,5 BA (3190658). BA = Bandkontakte



#### Printed-circuit board connector - MSTBC 2,5/16-ST-5,08 - 1808955

PCB connector, nominal current: 12 A, rated voltage (III/2): 320 V, nominal cross section: 2.5 mm<sup>2</sup>, number of positions: 16, pitch: 5.08 mm, connection method: Crimp connection, color: green, Corresponding female crimp contacts with current [A] and conductor cross section range [mm<sup>2</sup>] data: 10A/MSTBC-MT 0,5-1,0 (3190564); 10A/MSTBC-MT 0,5-1,0 BA (3190645); 12A/MSTBC-MT 1,5-2,5 (3190551); 12A/MSTBC-MT 1,5-2,5 BA (3190658). BA = Bandkontakte



#### Printed-circuit board connector - MSTBC 2,5/17-ST-5,08 - 1808968

PCB connector, nominal current: 12 A, rated voltage (III/2): 320 V, nominal cross section: 2.5 mm<sup>2</sup>, number of positions: 17, pitch: 5.08 mm, connection method: Crimp connection, color: green, Corresponding female crimp contacts with current [A] and conductor cross section range [mm<sup>2</sup>] data: 10A/MSTBC-MT 0,5-1,0 (3190564); 10A/MSTBC-MT 0,5-1,0 BA (3190645); 12A/MSTBC-MT 1,5-2,5 (3190551); 12A/MSTBC-MT 1,5-2,5 BA (3190658). BA = Bandkontakte



#### Printed-circuit board connector - MSTBC 2,5/24-ST-5,08 - 1809035

PCB connector, nominal current: 12 A, rated voltage (III/2): 320 V, nominal cross section: 2.5 mm<sup>2</sup>, number of positions: 24, pitch: 5.08 mm, connection method: Crimp connection, color: green, Corresponding female crimp contacts with current [A] and conductor cross section range [mm<sup>2</sup>] data: 10A/MSTBC-MT 0,5-1,0 (3190564); 10A/MSTBC-MT 0,5-1,0 BA (3190645); 12A/MSTBC-MT 1,5-2,5 (3190551); 12A/MSTBC-MT 1,5-2,5 BA (3190658). BA = Bandkontakte



## Feed-through terminal block - ZFKK 1,5-MSTBV-5,08 - 1873016

### Accessories

#### Printed-circuit board connector - MSTBC 2,5/ 2-STZ-5,08 - 1809501

PCB connector, nominal current: 12 A, rated voltage (III/2): 320 V, nominal cross section: 2.5 mm<sup>2</sup>, number of positions: 2, pitch: 5.08 mm, connection method: Crimp connection, color: green, Corresponding female crimp contacts with current [A] and conductor cross section range [mm<sup>2</sup>] data: 10A/MSTBC-MT 0,5-1,0 (3190564); 10A/MSTBC-MT 0,5-1,0 BA (3190645); 12A/MSTBC-MT 1,5-2,5 (3190551); 12A/MSTBC-MT 1,5-2,5 BA (3190658). BA = Bandkontakte



#### Printed-circuit board connector - MSTBC 2,5/ 5-STZ-5,08 - 1809530

PCB connector, nominal current: 12 A, rated voltage (III/2): 320 V, nominal cross section: 2.5 mm<sup>2</sup>, number of positions: 5, pitch: 5.08 mm, connection method: Crimp connection, color: green, Corresponding female crimp contacts with current [A] and conductor cross section range [mm<sup>2</sup>] data: 10A/MSTBC-MT 0,5-1,0 (3190564); 10A/MSTBC-MT 0,5-1,0 BA (3190645); 12A/MSTBC-MT 1,5-2,5 (3190551); 12A/MSTBC-MT 1,5-2,5 BA (3190658). BA = Bandkontakte



#### Printed-circuit board connector - MSTBC 2,5/ 6-STZ-5,08 - 1809543

PCB connector, nominal current: 12 A, rated voltage (III/2): 320 V, nominal cross section: 2.5 mm<sup>2</sup>, number of positions: 6, pitch: 5.08 mm, connection method: Crimp connection, color: green, Corresponding female crimp contacts with current [A] and conductor cross section range [mm<sup>2</sup>] data: 10A/MSTBC-MT 0,5-1,0 (3190564); 10A/MSTBC-MT 0,5-1,0 BA (3190645); 12A/MSTBC-MT 1,5-2,5 (3190551); 12A/MSTBC-MT 1,5-2,5 BA (3190658). BA = Bandkontakte



#### Printed-circuit board connector - MSTBC 2,5/ 9-STZ-5,08 - 1809572

PCB connector, nominal current: 12 A, rated voltage (III/2): 320 V, nominal cross section: 2.5 mm<sup>2</sup>, number of positions: 9, pitch: 5.08 mm, connection method: Crimp connection, color: green, Corresponding female crimp contacts with current [A] and conductor cross section range [mm<sup>2</sup>] data: 10A/MSTBC-MT 0,5-1,0 (3190564); 10A/MSTBC-MT 0,5-1,0 BA (3190645); 12A/MSTBC-MT 1,5-2,5 (3190551); 12A/MSTBC-MT 1,5-2,5 BA (3190658). BA = Bandkontakte



#### Printed-circuit board connector - MSTBC 2,5/15-STZ-5,08 - 1809637

PCB connector, nominal current: 12 A, rated voltage (III/2): 320 V, nominal cross section: 2.5 mm<sup>2</sup>, number of positions: 15, pitch: 5.08 mm, connection method: Crimp connection, color: green, Corresponding female crimp contacts with current [A] and conductor cross section range [mm<sup>2</sup>] data: 10A/MSTBC-MT 0,5-1,0 (3190564); 10A/MSTBC-MT 0,5-1,0 BA (3190645); 12A/MSTBC-MT 1,5-2,5 (3190551); 12A/MSTBC-MT 1,5-2,5 BA (3190658). BA = Bandkontakte



## Feed-through terminal block - ZFKK 1,5-MSTBV-5,08 - 1873016

### Accessories

#### Printed-circuit board connector - MSTBC 2,5/16-STZ-5,08 - 1809640

PCB connector, nominal current: 12 A, rated voltage (III/2): 320 V, nominal cross section: 2.5 mm<sup>2</sup>, number of positions: 16, pitch: 5.08 mm, connection method: Crimp connection, color: green, Corresponding female crimp contacts with current [A] and conductor cross section range [mm<sup>2</sup>] data: 10A/MSTBC-MT 0,5-1,0 (3190564); 10A/MSTBC-MT 0,5-1,0 BA (3190645); 12A/MSTBC-MT 1,5-2,5 (3190551); 12A/MSTBC-MT 1,5-2,5 BA (3190658). BA = Bandkontakte



#### Printed-circuit board connector - MSTBC 2,5/19-STZ-5,08 - 1809679

PCB connector, nominal current: 12 A, rated voltage (III/2): 320 V, nominal cross section: 2.5 mm<sup>2</sup>, number of positions: 19, pitch: 5.08 mm, connection method: Crimp connection, color: green, Corresponding female crimp contacts with current [A] and conductor cross section range [mm<sup>2</sup>] data: 10A/MSTBC-MT 0,5-1,0 (3190564); 10A/MSTBC-MT 0,5-1,0 BA (3190645); 12A/MSTBC-MT 1,5-2,5 (3190551); 12A/MSTBC-MT 1,5-2,5 BA (3190658). BA = Bandkontakte



#### Printed-circuit board connector - MSTBC 2,5/22-STZ-5,08 - 1809705

PCB connector, nominal current: 12 A, rated voltage (III/2): 320 V, nominal cross section: 2.5 mm<sup>2</sup>, number of positions: 22, pitch: 5.08 mm, connection method: Crimp connection, color: green, Corresponding female crimp contacts with current [A] and conductor cross section range [mm<sup>2</sup>] data: 10A/MSTBC-MT 0,5-1,0 (3190564); 10A/MSTBC-MT 0,5-1,0 BA (3190645); 12A/MSTBC-MT 1,5-2,5 (3190551); 12A/MSTBC-MT 1,5-2,5 BA (3190658). BA = Bandkontakte



#### Printed-circuit board connector - MSTBC 2,5/24-STZ-5,08 - 1809721

PCB connector, nominal current: 12 A, rated voltage (III/2): 320 V, nominal cross section: 2.5 mm<sup>2</sup>, number of positions: 24, pitch: 5.08 mm, connection method: Crimp connection, color: green, Corresponding female crimp contacts with current [A] and conductor cross section range [mm<sup>2</sup>] data: 10A/MSTBC-MT 0,5-1,0 (3190564); 10A/MSTBC-MT 0,5-1,0 BA (3190645); 12A/MSTBC-MT 1,5-2,5 (3190551); 12A/MSTBC-MT 1,5-2,5 BA (3190658). BA = Bandkontakte



#### Printed-circuit board connector - MSTBC 2,5/14-STZ-5,08 - 1809624

PCB connector, nominal current: 12 A, rated voltage (III/2): 320 V, nominal cross section: 2.5 mm<sup>2</sup>, number of positions: 14, pitch: 5.08 mm, connection method: Crimp connection, color: green, Corresponding female crimp contacts with current [A] and conductor cross section range [mm<sup>2</sup>] data: 10A/MSTBC-MT 0,5-1,0 (3190564); 10A/MSTBC-MT 0,5-1,0 BA (3190645); 12A/MSTBC-MT 1,5-2,5 (3190551); 12A/MSTBC-MT 1,5-2,5 BA (3190658). BA = Bandkontakte



## Feed-through terminal block - ZFKK 1,5-MSTBV-5,08 - 1873016

### Accessories

#### Printed-circuit board connector - MSTBC 2,5/20-STZ-5,08 - 1809682

PCB connector, nominal current: 12 A, rated voltage (III/2): 320 V, nominal cross section: 2.5 mm<sup>2</sup>, number of positions: 20, pitch: 5.08 mm, connection method: Crimp connection, color: green, Corresponding female crimp contacts with current [A] and conductor cross section range [mm<sup>2</sup>] data: 10A/MSTBC-MT 0,5-1,0 (3190564); 10A/MSTBC-MT 0,5-1,0 BA (3190645); 12A/MSTBC-MT 1,5-2,5 (3190551); 12A/MSTBC-MT 1,5-2,5 BA (3190658). BA = Bandkontakte



#### Printed-circuit board connector - MSTBC 2,5/17-STZ-5,08 - 1809653

PCB connector, nominal current: 12 A, rated voltage (III/2): 320 V, nominal cross section: 2.5 mm<sup>2</sup>, number of positions: 17, pitch: 5.08 mm, connection method: Crimp connection, color: green, Corresponding female crimp contacts with current [A] and conductor cross section range [mm<sup>2</sup>] data: 10A/MSTBC-MT 0,5-1,0 (3190564); 10A/MSTBC-MT 0,5-1,0 BA (3190645); 12A/MSTBC-MT 1,5-2,5 (3190551); 12A/MSTBC-MT 1,5-2,5 BA (3190658). BA = Bandkontakte



#### Printed-circuit board connector - MSTBC 2,5/10-STZ-5,08 - 1809585

PCB connector, nominal current: 12 A, rated voltage (III/2): 320 V, nominal cross section: 2.5 mm<sup>2</sup>, number of positions: 10, pitch: 5.08 mm, connection method: Crimp connection, color: green, Corresponding female crimp contacts with current [A] and conductor cross section range [mm<sup>2</sup>] data: 10A/MSTBC-MT 0,5-1,0 (3190564); 10A/MSTBC-MT 0,5-1,0 BA (3190645); 12A/MSTBC-MT 1,5-2,5 (3190551); 12A/MSTBC-MT 1,5-2,5 BA (3190658). BA = Bandkontakte



#### Printed-circuit board connector - MSTBC 2,5/ 4-STZ-5,08 - 1809527

PCB connector, nominal current: 12 A, rated voltage (III/2): 320 V, nominal cross section: 2.5 mm<sup>2</sup>, number of positions: 4, pitch: 5.08 mm, connection method: Crimp connection, color: green, Corresponding female crimp contacts with current [A] and conductor cross section range [mm<sup>2</sup>] data: 10A/MSTBC-MT 0,5-1,0 (3190564); 10A/MSTBC-MT 0,5-1,0 BA (3190645); 12A/MSTBC-MT 1,5-2,5 (3190551); 12A/MSTBC-MT 1,5-2,5 BA (3190658). BA = Bandkontakte



#### Printed-circuit board connector - MSTBC 2,5/23-STZ-5,08 - 1809718

PCB connector, nominal current: 12 A, rated voltage (III/2): 320 V, nominal cross section: 2.5 mm<sup>2</sup>, number of positions: 23, pitch: 5.08 mm, connection method: Crimp connection, color: green, Corresponding female crimp contacts with current [A] and conductor cross section range [mm<sup>2</sup>] data: 10A/MSTBC-MT 0,5-1,0 (3190564); 10A/MSTBC-MT 0,5-1,0 BA (3190645); 12A/MSTBC-MT 1,5-2,5 (3190551); 12A/MSTBC-MT 1,5-2,5 BA (3190658). BA = Bandkontakte





## Feed-through terminal block - ZFKK 1,5-MSTBV-5,08 - 1873016

### Accessories

#### Printed-circuit board connector - MSTBC 2,5/ 7-STZ-5,08 - 1809556

PCB connector, nominal current: 12 A, rated voltage (III/2): 320 V, nominal cross section: 2.5 mm<sup>2</sup>, number of positions: 7, pitch: 5.08 mm, connection method: Crimp connection, color: green, Corresponding female crimp contacts with current [A] and conductor cross section range [mm<sup>2</sup>] data: 10A/MSTBC-MT 0,5-1,0 (3190564); 10A/MSTBC-MT 0,5-1,0 BA (3190645); 12A/MSTBC-MT 1,5-2,5 (3190551); 12A/MSTBC-MT 1,5-2,5 BA (3190658). BA = Bandkontakte



#### Printed-circuit board connector - MSTBC 2,5/ 8-STZ-5,08 - 1809569

PCB connector, nominal current: 12 A, rated voltage (III/2): 320 V, nominal cross section: 2.5 mm<sup>2</sup>, number of positions: 8, pitch: 5.08 mm, connection method: Crimp connection, color: green, Corresponding female crimp contacts with current [A] and conductor cross section range [mm<sup>2</sup>] data: 10A/MSTBC-MT 0,5-1,0 (3190564); 10A/MSTBC-MT 0,5-1,0 BA (3190645); 12A/MSTBC-MT 1,5-2,5 (3190551); 12A/MSTBC-MT 1,5-2,5 BA (3190658). BA = Bandkontakte



#### Printed-circuit board connector - MSTBC 2,5/11-STZ-5,08 - 1809598

PCB connector, nominal current: 12 A, rated voltage (III/2): 320 V, nominal cross section: 2.5 mm<sup>2</sup>, number of positions: 11, pitch: 5.08 mm, connection method: Crimp connection, color: green, Corresponding female crimp contacts with current [A] and conductor cross section range [mm<sup>2</sup>] data: 10A/MSTBC-MT 0,5-1,0 (3190564); 10A/MSTBC-MT 0,5-1,0 BA (3190645); 12A/MSTBC-MT 1,5-2,5 (3190551); 12A/MSTBC-MT 1,5-2,5 BA (3190658). BA = Bandkontakte



#### Printed-circuit board connector - MSTB 2,5/ 3-STF-5,08 - 1777992

PCB connector, nominal current: 12 A, rated voltage (III/2): 320 V, nominal cross section: 2.5 mm<sup>2</sup>, number of positions: 3, pitch: 5.08 mm, connection method: Screw connection with tension sleeve, color: green, contact surface: Tin



#### Printed-circuit board connector - MSTB 2,5/ 6-STF-5,08 - 1778027

PCB connector, nominal current: 12 A, rated voltage (III/2): 320 V, nominal cross section: 2.5 mm<sup>2</sup>, number of positions: 6, pitch: 5.08 mm, connection method: Screw connection with tension sleeve, color: green, contact surface: Tin



## Feed-through terminal block - ZFKK 1,5-MSTBV-5,08 - 1873016

### Accessories

#### Printed-circuit board connector - MSTB 2,5/ 8-STF-5,08 - 1778043

PCB connector, nominal current: 12 A, rated voltage (III/2): 320 V, nominal cross section: 2.5 mm<sup>2</sup>, number of positions: 8, pitch: 5.08 mm, connection method: Screw connection with tension sleeve, color: green, contact surface: Tin



#### Printed-circuit board connector - MSTB 2,5/15-STF-5,08 - 1778111

PCB connector, nominal current: 12 A, rated voltage (III/2): 320 V, nominal cross section: 2.5 mm<sup>2</sup>, number of positions: 15, pitch: 5.08 mm, connection method: Screw connection with tension sleeve, color: green, contact surface: Tin



#### Printed-circuit board connector - MSTB 2,5/17-STF-5,08 - 1778137

PCB connector, nominal current: 12 A, rated voltage (III/2): 320 V, nominal cross section: 2.5 mm<sup>2</sup>, number of positions: 17, pitch: 5.08 mm, connection method: Screw connection with tension sleeve, color: green, contact surface: Tin



#### Printed-circuit board connector - MSTB 2,5/12-STF-5,08 - 1778085

PCB connector, nominal current: 12 A, rated voltage (III/2): 320 V, nominal cross section: 2.5 mm<sup>2</sup>, number of positions: 12, pitch: 5.08 mm, connection method: Screw connection with tension sleeve, color: green, contact surface: Tin



#### Printed-circuit board connector - MSTB 2,5/ 5-STF-5,08 - 1778014

PCB connector, nominal current: 12 A, rated voltage (III/2): 320 V, nominal cross section: 2.5 mm<sup>2</sup>, number of positions: 5, pitch: 5.08 mm, connection method: Screw connection with tension sleeve, color: green, contact surface: Tin



## Feed-through terminal block - ZFKK 1,5-MSTBV-5,08 - 1873016

### Accessories

#### Printed-circuit board connector - MSTB 2,5/ 9-STF-5,08 - 1778056

PCB connector, nominal current: 12 A, rated voltage (III/2): 320 V, nominal cross section: 2.5 mm<sup>2</sup>, number of positions: 9, pitch: 5.08 mm, connection method: Screw connection with tension sleeve, color: green, contact surface: Tin



#### Printed-circuit board connector - MSTB 2,5/ 2-STF-5,08 - 1777989

PCB connector, nominal current: 12 A, rated voltage (III/2): 320 V, nominal cross section: 2.5 mm<sup>2</sup>, number of positions: 2, pitch: 5.08 mm, connection method: Screw connection with tension sleeve, color: green, contact surface: Tin



#### Printed-circuit board connector - MSTB 2,5/18-STF-5,08 - 1778140

PCB connector, nominal current: 12 A, rated voltage (III/2): 320 V, nominal cross section: 2.5 mm<sup>2</sup>, number of positions: 18, pitch: 5.08 mm, connection method: Screw connection with tension sleeve, color: green, contact surface: Tin



#### Printed-circuit board connector - MSTB 2,5/11-STF-5,08 - 1778072

PCB connector, nominal current: 12 A, rated voltage (III/2): 320 V, nominal cross section: 2.5 mm<sup>2</sup>, number of positions: 11, pitch: 5.08 mm, connection method: Screw connection with tension sleeve, color: green, contact surface: Tin



#### Printed-circuit board connector - MSTB 2,5/ 7-STF-5,08 - 1778030

PCB connector, nominal current: 12 A, rated voltage (III/2): 320 V, nominal cross section: 2.5 mm<sup>2</sup>, number of positions: 7, pitch: 5.08 mm, connection method: Screw connection with tension sleeve, color: green, contact surface: Tin



## Feed-through terminal block - ZFKK 1,5-MSTBV-5,08 - 1873016

### Accessories

#### Printed-circuit board connector - MSTB 2,5/10-STF-5,08 - 1778069

PCB connector, nominal current: 12 A, rated voltage (III/2): 320 V, nominal cross section: 2.5 mm<sup>2</sup>, number of positions: 10, pitch: 5.08 mm, connection method: Screw connection with tension sleeve, color: green, contact surface: Tin



#### Printed-circuit board connector - MSTB 2,5/13-STF-5,08 - 1778098

PCB connector, nominal current: 12 A, rated voltage (III/2): 320 V, nominal cross section: 2.5 mm<sup>2</sup>, number of positions: 13, pitch: 5.08 mm, connection method: Screw connection with tension sleeve, color: green, contact surface: Tin



#### Printed-circuit board connector - MSTB 2,5/19-STF-5,08 - 1778153

PCB connector, nominal current: 12 A, rated voltage (III/2): 320 V, nominal cross section: 2.5 mm<sup>2</sup>, number of positions: 19, pitch: 5.08 mm, connection method: Screw connection with tension sleeve, color: green, contact surface: Tin



#### Printed-circuit board connector - MSTBT 2,5/ 2-STF-5,08 - 1805301

PCB connector, nominal current: 12 A, rated voltage (III/2): 320 V, nominal cross section: 2.5 mm<sup>2</sup>, number of positions: 2, pitch: 5.08 mm, connection method: Screw connection with tension sleeve, color: green, contact surface: Tin



#### Printed-circuit board connector - MSTBT 2,5/ 5-STF-5,08 - 1805330

PCB connector, nominal current: 12 A, rated voltage (III/2): 320 V, nominal cross section: 2.5 mm<sup>2</sup>, number of positions: 5, pitch: 5.08 mm, connection method: Screw connection with tension sleeve, color: green, contact surface: Tin



## Feed-through terminal block - ZFKK 1,5-MSTBV-5,08 - 1873016

### Accessories

#### Printed-circuit board connector - MSTBT 2,5/ 7-STF-5,08 - 1805356

PCB connector, nominal current: 12 A, rated voltage (III/2): 320 V, nominal cross section: 2.5 mm<sup>2</sup>, number of positions: 7, pitch: 5.08 mm, connection method: Screw connection with tension sleeve, color: green, contact surface: Tin



#### Printed-circuit board connector - MSTBT 2,5/ 9-STF-5,08 - 1805369

PCB connector, nominal current: 12 A, rated voltage (III/2): 320 V, nominal cross section: 2.5 mm<sup>2</sup>, number of positions: 9, pitch: 5.08 mm, connection method: Screw connection with tension sleeve, color: green, contact surface: Tin



#### Printed-circuit board connector - MSTBT 2,5/13-STF-5,08 - 1805408

PCB connector, nominal current: 12 A, rated voltage (III/2): 320 V, nominal cross section: 2.5 mm<sup>2</sup>, number of positions: 13, pitch: 5.08 mm, connection method: Screw connection with tension sleeve, color: green, contact surface: Tin



#### Printed-circuit board connector - MSTBT 2,5/14-STF-5,08 - 1805411

PCB connector, nominal current: 12 A, rated voltage (III/2): 320 V, nominal cross section: 2.5 mm<sup>2</sup>, number of positions: 14, pitch: 5.08 mm, connection method: Screw connection with tension sleeve, color: green, contact surface: Tin



#### Printed-circuit board connector - MSTBT 2,5/ 3-STF-5,08 - 1805314

PCB connector, nominal current: 12 A, rated voltage (III/2): 320 V, nominal cross section: 2.5 mm<sup>2</sup>, number of positions: 3, pitch: 5.08 mm, connection method: Screw connection with tension sleeve, color: green, contact surface: Tin



## Feed-through terminal block - ZFKK 1,5-MSTBV-5,08 - 1873016

### Accessories

#### Printed-circuit board connector - MSTBT 2,5/ 6-STF-5,08 - 1805343

PCB connector, nominal current: 12 A, rated voltage (III/2): 320 V, nominal cross section: 2.5 mm<sup>2</sup>, number of positions: 6, pitch: 5.08 mm, connection method: Screw connection with tension sleeve, color: green, contact surface: Tin



#### Printed-circuit board connector - MSTBT 2,5/16-STF-5,08 - 1805437

PCB connector, nominal current: 12 A, rated voltage (III/2): 320 V, nominal cross section: 2.5 mm<sup>2</sup>, number of positions: 16, pitch: 5.08 mm, connection method: Screw connection with tension sleeve, color: green, contact surface: Tin



#### Printed-circuit board connector - MSTBT 2,5/ 8-STF-5,08 - 1804661

PCB connector, nominal current: 12 A, rated voltage (III/2): 320 V, nominal cross section: 2.5 mm<sup>2</sup>, number of positions: 8, pitch: 5.08 mm, connection method: Screw connection with tension sleeve, color: green, contact surface: Tin



#### Printed-circuit board connector - MSTBT 2,5/ 4-STF-5,08 - 1805327

PCB connector, nominal current: 12 A, rated voltage (III/2): 320 V, nominal cross section: 2.5 mm<sup>2</sup>, number of positions: 4, pitch: 5.08 mm, connection method: Screw connection with tension sleeve, color: green, contact surface: Tin



#### Printed-circuit board connector - MVSTBR 2,5/10-STF-5,08 - 1835177

PCB connector, nominal current: 12 A, rated voltage (III/2): 320 V, nominal cross section: 2.5 mm<sup>2</sup>, number of positions: 10, pitch: 5.08 mm, connection method: Screw connection with tension sleeve, color: green, contact surface: Tin



## Feed-through terminal block - ZFKK 1,5-MSTBV-5,08 - 1873016

### Accessories

#### Printed-circuit board connector - MVSTBR 2,5/13-STF-5,08 - 1835203



PCB connector, nominal current: 12 A, rated voltage (III/2): 320 V, nominal cross section: 2.5 mm<sup>2</sup>, number of positions: 13, pitch: 5.08 mm, connection method: Screw connection with tension sleeve, color: green, contact surface: Tin

#### Printed-circuit board connector - MVSTBR 2,5/16-STF-5,08 - 1835232



PCB connector, nominal current: 12 A, rated voltage (III/2): 320 V, nominal cross section: 2.5 mm<sup>2</sup>, number of positions: 16, pitch: 5.08 mm, connection method: Screw connection with tension sleeve, color: green, contact surface: Tin

#### Printed-circuit board connector - MVSTBR 2,5/17-STF-5,08 - 1835245



PCB connector, nominal current: 12 A, rated voltage (III/2): 320 V, nominal cross section: 2.5 mm<sup>2</sup>, number of positions: 17, pitch: 5.08 mm, connection method: Screw connection with tension sleeve, color: green, contact surface: Tin

#### Printed-circuit board connector - MVSTBR 2,5/ 7-STF-5,08 - 1835148



PCB connector, nominal current: 12 A, rated voltage (III/2): 320 V, nominal cross section: 2.5 mm<sup>2</sup>, number of positions: 7, pitch: 5.08 mm, connection method: Screw connection with tension sleeve, color: green, contact surface: Tin

#### Printed-circuit board connector - MVSTBR 2,5/18-STF-5,08 - 1835258



PCB connector, nominal current: 12 A, rated voltage (III/2): 320 V, nominal cross section: 2.5 mm<sup>2</sup>, number of positions: 18, pitch: 5.08 mm, connection method: Screw connection with tension sleeve, color: green, contact surface: Tin

## Feed-through terminal block - ZFKK 1,5-MSTBV-5,08 - 1873016

### Accessories

Printed-circuit board connector - MVSTBR 2,5/ 4-STF-5,08 - 1835119



PCB connector, nominal current: 12 A, rated voltage (III/2): 320 V, nominal cross section: 2.5 mm<sup>2</sup>, number of positions: 4, pitch: 5.08 mm, connection method: Screw connection with tension sleeve, color: green, contact surface: Tin

---

Printed-circuit board connector - MVSTBR 2,5/ 9-STF-5,08 - 1835164



PCB connector, nominal current: 12 A, rated voltage (III/2): 320 V, nominal cross section: 2.5 mm<sup>2</sup>, number of positions: 9, pitch: 5.08 mm, connection method: Screw connection with tension sleeve, color: green, contact surface: Tin

---

Printed-circuit board connector - MVSTBR 2,5/14-STF-5,08 - 1835216



PCB connector, nominal current: 12 A, rated voltage (III/2): 320 V, nominal cross section: 2.5 mm<sup>2</sup>, number of positions: 14, pitch: 5.08 mm, connection method: Screw connection with tension sleeve, color: green, contact surface: Tin

---

Printed-circuit board connector - MVSTBR 2,5/20-STF-5,08 - 1835274



PCB connector, nominal current: 12 A, rated voltage (III/2): 320 V, nominal cross section: 2.5 mm<sup>2</sup>, number of positions: 20, pitch: 5.08 mm, connection method: Screw connection with tension sleeve, color: green, contact surface: Tin

---

Printed-circuit board connector - MVSTBR 2,5/ 3-STF-5,08 - 1835106



PCB connector, nominal current: 12 A, rated voltage (III/2): 320 V, nominal cross section: 2.5 mm<sup>2</sup>, number of positions: 3, pitch: 5.08 mm, connection method: Screw connection with tension sleeve, color: green, contact surface: Tin

---



## Feed-through terminal block - ZFKK 1,5-MSTBV-5,08 - 1873016

### Accessories

#### Printed-circuit board connector - MVSTBR 2,5/19-STF-5,08 - 1835261



PCB connector, nominal current: 12 A, rated voltage (III/2): 320 V, nominal cross section: 2.5 mm<sup>2</sup>, number of positions: 19, pitch: 5.08 mm, connection method: Screw connection with tension sleeve, color: green, contact surface: Tin

---

#### Printed-circuit board connector - FKC 2,5/ 3-STF-5,08 - 1873210



PCB connector, nominal current: 12 A, rated voltage (III/2): 320 V, nominal cross section: 2.5 mm<sup>2</sup>, number of positions: 3, pitch: 5.08 mm, connection method: Push-in spring connection, color: green, contact surface: Tin

---

#### Printed-circuit board connector - FKC 2,5/ 4-STF-5,08 - 1873223



PCB connector, nominal current: 12 A, rated voltage (III/2): 320 V, nominal cross section: 2.5 mm<sup>2</sup>, number of positions: 4, pitch: 5.08 mm, connection method: Push-in spring connection, color: green, contact surface: Tin

---

#### Printed-circuit board connector - FKC 2,5/ 6-STF-5,08 - 1873249



PCB connector, nominal current: 12 A, rated voltage (III/2): 320 V, nominal cross section: 2.5 mm<sup>2</sup>, number of positions: 6, pitch: 5.08 mm, connection method: Push-in spring connection, color: green, contact surface: Tin

---

#### Printed-circuit board connector - FKC 2,5/11-STF-5,08 - 1873294



PCB connector, nominal current: 12 A, rated voltage (III/2): 320 V, nominal cross section: 2.5 mm<sup>2</sup>, number of positions: 11, pitch: 5.08 mm, connection method: Push-in spring connection, color: green, contact surface: Tin

## Feed-through terminal block - ZFKK 1,5-MSTBV-5,08 - 1873016

### Accessories

#### Printed-circuit board connector - FKC 2,5/13-STF-5,08 - 1873317

PCB connector, nominal current: 12 A, rated voltage (III/2): 320 V, nominal cross section: 2.5 mm<sup>2</sup>, number of positions: 13, pitch: 5.08 mm, connection method: Push-in spring connection, color: green, contact surface: Tin



#### Printed-circuit board connector - FKC 2,5/15-STF-5,08 - 1873333

PCB connector, nominal current: 12 A, rated voltage (III/2): 320 V, nominal cross section: 2.5 mm<sup>2</sup>, number of positions: 15, pitch: 5.08 mm, connection method: Push-in spring connection, color: green, contact surface: Tin



#### Printed-circuit board connector - FKC 2,5/ 5-STF-5,08 - 1873236

PCB connector, nominal current: 12 A, rated voltage (III/2): 320 V, nominal cross section: 2.5 mm<sup>2</sup>, number of positions: 5, pitch: 5.08 mm, connection method: Push-in spring connection, color: green, contact surface: Tin



#### Printed-circuit board connector - FKC 2,5/16-STF-5,08 - 1873346

PCB connector, nominal current: 12 A, rated voltage (III/2): 320 V, nominal cross section: 2.5 mm<sup>2</sup>, number of positions: 16, pitch: 5.08 mm, connection method: Push-in spring connection, color: green, contact surface: Tin



#### Printed-circuit board connector - FKC 2,5/ 7-STF-5,08 - 1873252

PCB connector, nominal current: 12 A, rated voltage (III/2): 320 V, nominal cross section: 2.5 mm<sup>2</sup>, number of positions: 7, pitch: 5.08 mm, connection method: Push-in spring connection, color: green, contact surface: Tin



## Feed-through terminal block - ZFKK 1,5-MSTBV-5,08 - 1873016

### Accessories

#### Printed-circuit board connector - FKC 2,5/12-STF-5,08 - 1873304

PCB connector, nominal current: 12 A, rated voltage (III/2): 320 V, nominal cross section: 2.5 mm<sup>2</sup>, number of positions: 12, pitch: 5.08 mm, connection method: Push-in spring connection, color: green, contact surface: Tin



#### Printed-circuit board connector - FKC 2,5/14-STF-5,08 - 1873320

PCB connector, nominal current: 12 A, rated voltage (III/2): 320 V, nominal cross section: 2.5 mm<sup>2</sup>, number of positions: 14, pitch: 5.08 mm, connection method: Push-in spring connection, color: green, contact surface: Tin



#### Printed-circuit board connector - FKC 2,5/ 9-STF-5,08 - 1873278

PCB connector, nominal current: 12 A, rated voltage (III/2): 320 V, nominal cross section: 2.5 mm<sup>2</sup>, number of positions: 9, pitch: 5.08 mm, connection method: Push-in spring connection, color: green, contact surface: Tin



#### Printed-circuit board connector - FKCVR 2,5/ 2-STF-5,08 - 1874109

PCB connector, nominal current: 12 A, rated voltage (III/2): 320 V, nominal cross section: 2.5 mm<sup>2</sup>, number of positions: 2, pitch: 5.08 mm, connection method: Push-in spring connection, color: green, contact surface: Tin



#### Printed-circuit board connector - FKCVR 2,5/ 3-STF-5,08 - 1874112

PCB connector, nominal current: 12 A, rated voltage (III/2): 320 V, nominal cross section: 2.5 mm<sup>2</sup>, number of positions: 3, pitch: 5.08 mm, connection method: Push-in spring connection, color: green, contact surface: Tin

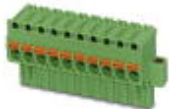

## Feed-through terminal block - ZFKK 1,5-MSTBV-5,08 - 1873016

### Accessories

#### Printed-circuit board connector - FKCVR 2,5/ 7-STF-5,08 - 1874154

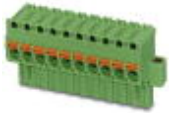

PCB connector, nominal current: 12 A, rated voltage (III/2): 320 V, nominal cross section: 2.5 mm<sup>2</sup>, number of positions: 7, pitch: 5.08 mm, connection method: Push-in spring connection, color: green, contact surface: Tin

---

#### Printed-circuit board connector - FKCVR 2,5/ 8-STF-5,08 - 1874167

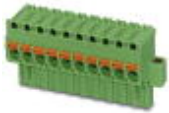

PCB connector, nominal current: 12 A, rated voltage (III/2): 320 V, nominal cross section: 2.5 mm<sup>2</sup>, number of positions: 8, pitch: 5.08 mm, connection method: Push-in spring connection, color: green, contact surface: Tin

---

#### Printed-circuit board connector - FKCVR 2,5/10-STF-5,08 - 1874183

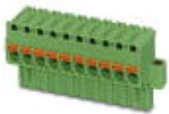

PCB connector, nominal current: 12 A, rated voltage (III/2): 320 V, nominal cross section: 2.5 mm<sup>2</sup>, number of positions: 10, pitch: 5.08 mm, connection method: Push-in spring connection, color: green, contact surface: Tin

---

#### Printed-circuit board connector - FKCVR 2,5/12-STF-5,08 - 1874206



PCB connector, nominal current: 12 A, rated voltage (III/2): 320 V, nominal cross section: 2.5 mm<sup>2</sup>, number of positions: 12, pitch: 5.08 mm, connection method: Push-in spring connection, color: green, contact surface: Tin

---

#### Printed-circuit board connector - FKCVR 2,5/14-STF-5,08 - 1874222



PCB connector, nominal current: 12 A, rated voltage (III/2): 320 V, nominal cross section: 2.5 mm<sup>2</sup>, number of positions: 14, pitch: 5.08 mm, connection method: Push-in spring connection, color: green, contact surface: Tin

## Feed-through terminal block - ZFKK 1,5-MSTBV-5,08 - 1873016

### Accessories

#### Printed-circuit board connector - FKCVR 2,5/16-STF-5,08 - 1874248

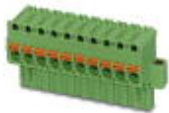

PCB connector, nominal current: 12 A, rated voltage (III/2): 320 V, nominal cross section: 2.5 mm<sup>2</sup>, number of positions: 16, pitch: 5.08 mm, connection method: Push-in spring connection, color: green, contact surface: Tin

---

#### Printed-circuit board connector - FKCVR 2,5/15-STF-5,08 - 1874235



PCB connector, nominal current: 12 A, rated voltage (III/2): 320 V, nominal cross section: 2.5 mm<sup>2</sup>, number of positions: 15, pitch: 5.08 mm, connection method: Push-in spring connection, color: green, contact surface: Tin

---

#### Printed-circuit board connector - FKCVR 2,5/ 5-STF-5,08 - 1874138



PCB connector, nominal current: 12 A, rated voltage (III/2): 320 V, nominal cross section: 2.5 mm<sup>2</sup>, number of positions: 5, pitch: 5.08 mm, connection method: Push-in spring connection, color: green, contact surface: Tin

---

#### Printed-circuit board connector - FKCVR 2,5/ 9-STF-5,08 - 1874170



PCB connector, nominal current: 12 A, rated voltage (III/2): 320 V, nominal cross section: 2.5 mm<sup>2</sup>, number of positions: 9, pitch: 5.08 mm, connection method: Push-in spring connection, color: green, contact surface: Tin

---

#### Printed-circuit board connector - FKCVR 2,5/11-STF-5,08 - 1874196



PCB connector, nominal current: 12 A, rated voltage (III/2): 320 V, nominal cross section: 2.5 mm<sup>2</sup>, number of positions: 11, pitch: 5.08 mm, connection method: Push-in spring connection, color: green, contact surface: Tin

---

## Feed-through terminal block - ZFKK 1,5-MSTBV-5,08 - 1873016

### Accessories

#### Printed-circuit board connector - QC 1/ 2-STF-5,08 - 1883352

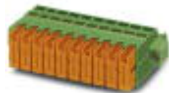

PCB connector, nominal current: 10 A, rated voltage (III/2): 630 V, nominal cross section: 1 mm<sup>2</sup>, number of positions: 2, pitch: 5.08 mm, connection method: Displacement connection, color: green, contact surface: Tin

---

#### Printed-circuit board connector - QC 1/ 6-STF-5,08 - 1883394



PCB connector, nominal current: 10 A, rated voltage (III/2): 630 V, nominal cross section: 1 mm<sup>2</sup>, number of positions: 6, pitch: 5.08 mm, connection method: Displacement connection, color: green, contact surface: Tin

---

#### Printed-circuit board connector - QC 1/ 7-STF-5,08 - 1883404



PCB connector, nominal current: 10 A, rated voltage (III/2): 630 V, nominal cross section: 1 mm<sup>2</sup>, number of positions: 7, pitch: 5.08 mm, connection method: Displacement connection, color: green, contact surface: Tin

---

#### Printed-circuit board connector - QC 1/ 9-STF-5,08 - 1883420

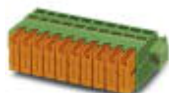

PCB connector, nominal current: 10 A, rated voltage (III/2): 630 V, nominal cross section: 1 mm<sup>2</sup>, number of positions: 9, pitch: 5.08 mm, connection method: Displacement connection, color: green, contact surface: Tin

---

#### Printed-circuit board connector - QC 1/11-STF-5,08 - 1883446



PCB connector, nominal current: 10 A, rated voltage (III/2): 630 V, nominal cross section: 1 mm<sup>2</sup>, number of positions: 11, pitch: 5.08 mm, connection method: Displacement connection, color: green, contact surface: Tin

## Feed-through terminal block - ZFKK 1,5-MSTBV-5,08 - 1873016

### Accessories

Printed-circuit board connector - QC 1/15-STF-5,08 - 1883886

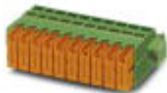

PCB connector, nominal current: 10 A, rated voltage (III/2): 630 V, nominal cross section: 1 mm<sup>2</sup>, number of positions: 15, pitch: 5.08 mm, connection method: Displacement connection, color: green, contact surface: Tin

Printed-circuit board connector - QC 1/ 4-STF-5,08 - 1883378



PCB connector, nominal current: 10 A, rated voltage (III/2): 630 V, nominal cross section: 1 mm<sup>2</sup>, number of positions: 4, pitch: 5.08 mm, connection method: Displacement connection, color: green, contact surface: Tin

Printed-circuit board connector - QC 1/16-STF-5,08 - 1883899



PCB connector, nominal current: 10 A, rated voltage (III/2): 630 V, nominal cross section: 1 mm<sup>2</sup>, number of positions: 16, pitch: 5.08 mm, connection method: Displacement connection, color: green, contact surface: Tin

Printed-circuit board connector - QC 1/ 5-STF-5,08 - 1883381

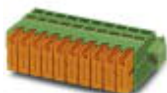

PCB connector, nominal current: 10 A, rated voltage (III/2): 630 V, nominal cross section: 1 mm<sup>2</sup>, number of positions: 5, pitch: 5.08 mm, connection method: Displacement connection, color: green, contact surface: Tin

Printed-circuit board connector - QC 1/12-STF-5,08 - 1883459



PCB connector, nominal current: 10 A, rated voltage (III/2): 630 V, nominal cross section: 1 mm<sup>2</sup>, number of positions: 12, pitch: 5.08 mm, connection method: Displacement connection, color: green, contact surface: Tin

## Feed-through terminal block - ZFKK 1,5-MSTBV-5,08 - 1873016

### Accessories

#### Printed-circuit board connector - QC 1/10-STF-5,08 - 1883433

PCB connector, nominal current: 10 A, rated voltage (III/2): 630 V, nominal cross section: 1 mm<sup>2</sup>, number of positions: 10, pitch: 5.08 mm, connection method: Displacement connection, color: green, contact surface: Tin

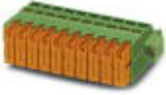

#### Printed-circuit board connector - QC 1/ 8-STF-5,08 - 1883417

PCB connector, nominal current: 10 A, rated voltage (III/2): 630 V, nominal cross section: 1 mm<sup>2</sup>, number of positions: 8, pitch: 5.08 mm, connection method: Displacement connection, color: green, contact surface: Tin



#### Printed-circuit board connector - MSTBC 2,5/ 7-STZF-5,08 - 1809789

PCB connector, nominal current: 12 A, rated voltage (III/2): 320 V, nominal cross section: 2.5 mm<sup>2</sup>, number of positions: 7, pitch: 5.08 mm, connection method: Crimp connection, color: green, Corresponding female crimp contacts with current [A] and conductor cross section range [mm<sup>2</sup>] data: 10A/MSTBC-MT 0,5-1,0 (3190564); 10A/MSTBC-MT 0,5-1,0 BA (3190645); 12A/MSTBC-MT 1,5-2,5 (3190551); 12A/MSTBC-MT 1,5-2,5 BA (3190658). BA = Bandkontakte



#### Printed-circuit board connector - MSTBC 2,5/ 8-STZF-5,08 - 1809792

PCB connector, nominal current: 12 A, rated voltage (III/2): 320 V, nominal cross section: 2.5 mm<sup>2</sup>, number of positions: 8, pitch: 5.08 mm, connection method: Crimp connection, color: green, Corresponding female crimp contacts with current [A] and conductor cross section range [mm<sup>2</sup>] data: 10A/MSTBC-MT 0,5-1,0 (3190564); 10A/MSTBC-MT 0,5-1,0 BA (3190645); 12A/MSTBC-MT 1,5-2,5 (3190551); 12A/MSTBC-MT 1,5-2,5 BA (3190658). BA = Bandkontakte



#### Printed-circuit board connector - MSTBC 2,5/12-STZF-5,08 - 1809831

PCB connector, nominal current: 12 A, rated voltage (III/2): 320 V, nominal cross section: 2.5 mm<sup>2</sup>, number of positions: 12, pitch: 5.08 mm, connection method: Crimp connection, color: green, Corresponding female crimp contacts with current [A] and conductor cross section range [mm<sup>2</sup>] data: 10A/MSTBC-MT 0,5-1,0 (3190564); 10A/MSTBC-MT 0,5-1,0 BA (3190645); 12A/MSTBC-MT 1,5-2,5 (3190551); 12A/MSTBC-MT 1,5-2,5 BA (3190658). BA = Bandkontakte





## Feed-through terminal block - ZFKK 1,5-MSTBV-5,08 - 1873016

### Accessories

#### Printed-circuit board connector - MSTBC 2,5/14-STZF-5,08 - 1809857

PCB connector, nominal current: 12 A, rated voltage (III/2): 320 V, nominal cross section: 2.5 mm<sup>2</sup>, number of positions: 14, pitch: 5.08 mm, connection method: Crimp connection, color: green, Corresponding female crimp contacts with current [A] and conductor cross section range [mm<sup>2</sup>] data: 10A/MSTBC-MT 0,5-1,0 (3190564); 10A/MSTBC-MT 0,5-1,0 BA (3190645); 12A/MSTBC-MT 1,5-2,5 (3190551); 12A/MSTBC-MT 1,5-2,5 BA (3190658). BA = Bandkontakte



#### Printed-circuit board connector - MSTBC 2,5/19-STZF-5,08 - 1809909

PCB connector, nominal current: 12 A, rated voltage (III/2): 320 V, nominal cross section: 2.5 mm<sup>2</sup>, number of positions: 19, pitch: 5.08 mm, connection method: Crimp connection, color: green, Corresponding female crimp contacts with current [A] and conductor cross section range [mm<sup>2</sup>] data: 10A/MSTBC-MT 0,5-1,0 (3190564); 10A/MSTBC-MT 0,5-1,0 BA (3190645); 12A/MSTBC-MT 1,5-2,5 (3190551); 12A/MSTBC-MT 1,5-2,5 BA (3190658). BA = Bandkontakte



#### Printed-circuit board connector - MSTBC 2,5/20-STZF-5,08 - 1809912

PCB connector, nominal current: 12 A, rated voltage (III/2): 320 V, nominal cross section: 2.5 mm<sup>2</sup>, number of positions: 20, pitch: 5.08 mm, connection method: Crimp connection, color: green, Corresponding female crimp contacts with current [A] and conductor cross section range [mm<sup>2</sup>] data: 10A/MSTBC-MT 0,5-1,0 (3190564); 10A/MSTBC-MT 0,5-1,0 BA (3190645); 12A/MSTBC-MT 1,5-2,5 (3190551); 12A/MSTBC-MT 1,5-2,5 BA (3190658). BA = Bandkontakte



#### Printed-circuit board connector - MSTBC 2,5/21-STZF-5,08 - 1809925

PCB connector, nominal current: 12 A, rated voltage (III/2): 320 V, nominal cross section: 2.5 mm<sup>2</sup>, number of positions: 21, pitch: 5.08 mm, connection method: Crimp connection, color: green, Corresponding female crimp contacts with current [A] and conductor cross section range [mm<sup>2</sup>] data: 10A/MSTBC-MT 0,5-1,0 (3190564); 10A/MSTBC-MT 0,5-1,0 BA (3190645); 12A/MSTBC-MT 1,5-2,5 (3190551); 12A/MSTBC-MT 1,5-2,5 BA (3190658). BA = Bandkontakte



#### Printed-circuit board connector - MSTBC 2,5/ 3-STZF-5,08 - 1809747

PCB connector, nominal current: 12 A, rated voltage (III/2): 320 V, nominal cross section: 2.5 mm<sup>2</sup>, number of positions: 3, pitch: 5.08 mm, connection method: Crimp connection, color: green, Corresponding female crimp contacts with current [A] and conductor cross section range [mm<sup>2</sup>] data: 10A/MSTBC-MT 0,5-1,0 (3190564); 10A/MSTBC-MT 0,5-1,0 BA (3190645); 12A/MSTBC-MT 1,5-2,5 (3190551); 12A/MSTBC-MT 1,5-2,5 BA (3190658). BA = Bandkontakte



## Feed-through terminal block - ZFKK 1,5-MSTBV-5,08 - 1873016

### Accessories

#### Printed-circuit board connector - MSTBC 2,5/ 9-STZF-5,08 - 1809802

PCB connector, nominal current: 12 A, rated voltage (III/2): 320 V, nominal cross section: 2.5 mm<sup>2</sup>, number of positions: 9, pitch: 5.08 mm, connection method: Crimp connection, color: green, Corresponding female crimp contacts with current [A] and conductor cross section range [mm<sup>2</sup>] data: 10A/MSTBC-MT 0,5-1,0 (3190564); 10A/MSTBC-MT 0,5-1,0 BA (3190645); 12A/MSTBC-MT 1,5-2,5 (3190551); 12A/MSTBC-MT 1,5-2,5 BA (3190658). BA = Bandkontakte



#### Printed-circuit board connector - MSTBC 2,5/11-STZF-5,08 - 1809828

PCB connector, nominal current: 12 A, rated voltage (III/2): 320 V, nominal cross section: 2.5 mm<sup>2</sup>, number of positions: 11, pitch: 5.08 mm, connection method: Crimp connection, color: green, Corresponding female crimp contacts with current [A] and conductor cross section range [mm<sup>2</sup>] data: 10A/MSTBC-MT 0,5-1,0 (3190564); 10A/MSTBC-MT 0,5-1,0 BA (3190645); 12A/MSTBC-MT 1,5-2,5 (3190551); 12A/MSTBC-MT 1,5-2,5 BA (3190658). BA = Bandkontakte



#### Printed-circuit board connector - MSTBC 2,5/15-STZF-5,08 - 1809860

PCB connector, nominal current: 12 A, rated voltage (III/2): 320 V, nominal cross section: 2.5 mm<sup>2</sup>, number of positions: 15, pitch: 5.08 mm, connection method: Crimp connection, color: green, contact surface: Tin, Corresponding female crimp contacts with current [A] and conductor cross section range [mm<sup>2</sup>] data: 10A/MSTBC-MT 0,5-1,0 (3190564); 10A/MSTBC-MT 0,5-1,0 BA (3190645); 12A/MSTBC-MT 1,5-2,5 (3190551); 12A/MSTBC-MT 1,5-2,5 BA (3190658). BA = Bandkontakte



#### Printed-circuit board connector - MSTBC 2,5/17-STZF-5,08 - 1809886

PCB connector, nominal current: 12 A, rated voltage (III/2): 320 V, nominal cross section: 2.5 mm<sup>2</sup>, number of positions: 17, pitch: 5.08 mm, connection method: Crimp connection, color: green, Corresponding female crimp contacts with current [A] and conductor cross section range [mm<sup>2</sup>] data: 10A/MSTBC-MT 0,5-1,0 (3190564); 10A/MSTBC-MT 0,5-1,0 BA (3190645); 12A/MSTBC-MT 1,5-2,5 (3190551); 12A/MSTBC-MT 1,5-2,5 BA (3190658). BA = Bandkontakte



#### Printed-circuit board connector - MSTBC 2,5/22-STZF-5,08 - 1809938

PCB connector, nominal current: 12 A, rated voltage (III/2): 320 V, nominal cross section: 2.5 mm<sup>2</sup>, number of positions: 22, pitch: 5.08 mm, connection method: Crimp connection, color: green, Corresponding female crimp contacts with current [A] and conductor cross section range [mm<sup>2</sup>] data: 10A/MSTBC-MT 0,5-1,0 (3190564); 10A/MSTBC-MT 0,5-1,0 BA (3190645); 12A/MSTBC-MT 1,5-2,5 (3190551); 12A/MSTBC-MT 1,5-2,5 BA (3190658). BA = Bandkontakte



## Feed-through terminal block - ZFKK 1,5-MSTBV-5,08 - 1873016

### Accessories

Printed-circuit board connector - MSTBC 2,5/ 2-STZF-5,08 - 1809734



PCB connector, nominal current: 12 A, rated voltage (III/2): 320 V, nominal cross section: 2.5 mm<sup>2</sup>, number of positions: 2, pitch: 5.08 mm, connection method: Crimp connection, color: green, Corresponding female crimp contacts with current [A] and conductor cross section range [mm<sup>2</sup>] data: 10A/MSTBC-MT 0,5-1,0 (3190564); 10A/MSTBC-MT 0,5-1,0 BA (3190645); 12A/MSTBC-MT 1,5-2,5 (3190551); 12A/MSTBC-MT 1,5-2,5 BA (3190658). BA = Bandkontakte

---

Phoenix Contact 2020 © - all rights reserved  
<http://www.phoenixcontact.com>

PHOENIX CONTACT GmbH & Co. KG  
Flachsmarktstr. 8  
32825 Blomberg  
Germany  
Tel. +49 5235 300  
Fax +49 5235 3 41200  
<http://www.phoenixcontact.com>