

### Mounting Aperture of 16 mm

- Modular construction (Pushbutton + Case + Lamp + Switch Unit)
- “Snap-in” switch unit for quick and easy, tool-free assembly
- Wide range of switching capacity from general to microload
- High reliability IP65 or IP40 models
- Short mounting depth, less than 28.5 mm below panel
- Terminal layout simplifies common wiring
- UL and CSA approved, VDE (pending)
- Conforms to EN60943-5-1, IEC947-5-1



## Ordering Information

### ■ CONSTRUCTION

#### Flange Shape

Rectangular (A16□-J)	Square (A16□-A)	Round (A16□-T)
-------------------------	--------------------	-------------------

#### Protective Case and Terminal Type

- **Protective Structure**  
IP40/Oil-resistant IP65
- **Terminal Type**  
Solder terminals  
(tab terminals #110)

#### Lamp

- LED
- Incandescent lamp

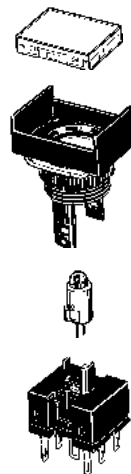

#### Available Colors

- For LED/incandescent  
Red, green, yellow, white, blue
  - For non-illuminated  
Red, green, yellow, white, blue, black
- (Actual color of yellow pushbuttons more closely resembles amber than true yellow.)

#### Switch Unit Specifications

- **Ratings**  
125 VAC: 5 A  
250 VAC: 3 A  
30 VDC 3 A  
Minimum applicable load: 1 mA at 5 VDC

**Structure of Pushbutton**



Lens



Legend plate









Dispersion plate

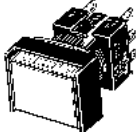
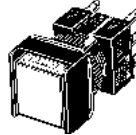
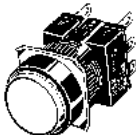
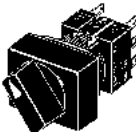
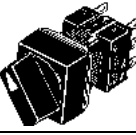
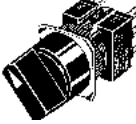

Reflective plunger

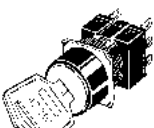
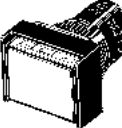
**MODELS**

Item	Shape		Part number
Pushbutton Switches	Rectangular		A16-J A165-J
	Square		A16-A A165-A
	Round		A16-T A165-T
Knob-type Selector Switches	Rectangular		A165S-J (Non-illuminated) A165W-J (Illuminated)
	Square		A165S-A (Non-illuminated) A165W-A (Illuminated)
	Round		A165S-T (Non-illuminated) A165W-T (Illuminated)

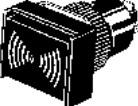
Item	Shape		Part number
Key-type Selector Switches	Rectangular		A165K-J
	Square		A165K-A
	Round		A165K-T
Pilot Lights	Rectangular		M16-J M165-J
	Square		M16-A M165-A
	Round		M16-T M165-T
Emergency Stop Switches			A165E
Buzzers			M2BJ-B M2BJ-BH

**■ PART NUMBER LEGEND A16 NON-ILLUMINATED PUSHBUTTONS (COMPLETE ASSEMBLY)**

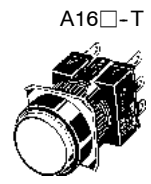
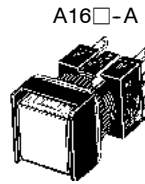
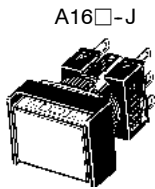

**A16 Part number nomenclature**

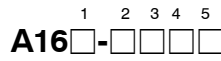

**1 Enclosure Rating**

Code	Description
None	IP40
5	IP65 oil-resistant

**4 Operating Function**

Code	Description
M	Momentary
A	Alternate action

**2 Shape**

Code	Shape	Description
T	Round	Extended
A	Square	2 directions, guarded
J	Rectangular	2 directions, guarded

**5 Contact form and terminal type**

Code	Contact form	Terminal
1	1C SPDT (See Note)	Solder terminal
2	2C DPDT (See Note)	Solder terminal

Note: SPDT: Single Pole, Double Throw  
DPDT: Double Pole, Double Throw

**3 Operator Color**

Code	Description
R	Red
Y	Yellow
G	Green
W	White
A	Blue
B	Black (for non-illuminated only)

(Actual color of yellow pushbuttons more closely resembles amber than true yellow.)

## ■ PART NUMBERS: NON-ILLUMINATED PUSHBUTTON SWITCHES (COMPLETE ASSEMBLY)

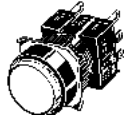
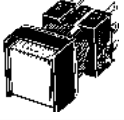
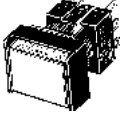
Description	Shape	Contact	Part number			
			Momentary		Alternate action (See Note 2.)	
			Enclosed (IP40)	Oiltight (IP65)	Enclosed (IP40)	Oiltight (IP65)
Non-Illuminated Standard Button	Round 	SPDT	A16-T□M-1	A165-T□M-1	A16-T□A-1	A165-T□A-1
		DPDT	A16-T□M-2	A165-T□M-2	A16-T□A-2	A165-T□A-2
	Square 	SPDT	A16-A□M-1	A165-A□M-1	A16-A□A-1	A165-A□A-1
		DPDT	A16-A□M-2	A165-A□M-2	A16-A□A-2	A165-A□A-2
	Rectangular 	SPDT	A16-J□M-1	A165-J□M-1	A16-J□A-1	A165-J□A-1
		DPDT	A16-J□M-2	A165-J□M-2	A16-J□A-2	A165-J□A-2

Note: 1. To complete the part number, in place of the □ symbol, specify the color code from the table below.

2. Also described as Push-on / Push-off operation.

### Operator Color Codes

(Actual color of yellow pushbuttons more closely resembles amber than true yellow.)

Code	Color
R	Red
Y	Yellow
G	Green
W	White
A	Blue
B	Black

Note: Also described as Push-on/Push-off operation.

■ PART NUMBER LEGEND M16 ASSEMBLED PILOT LIGHTS

M16□-J



M16□-A





M16□-T

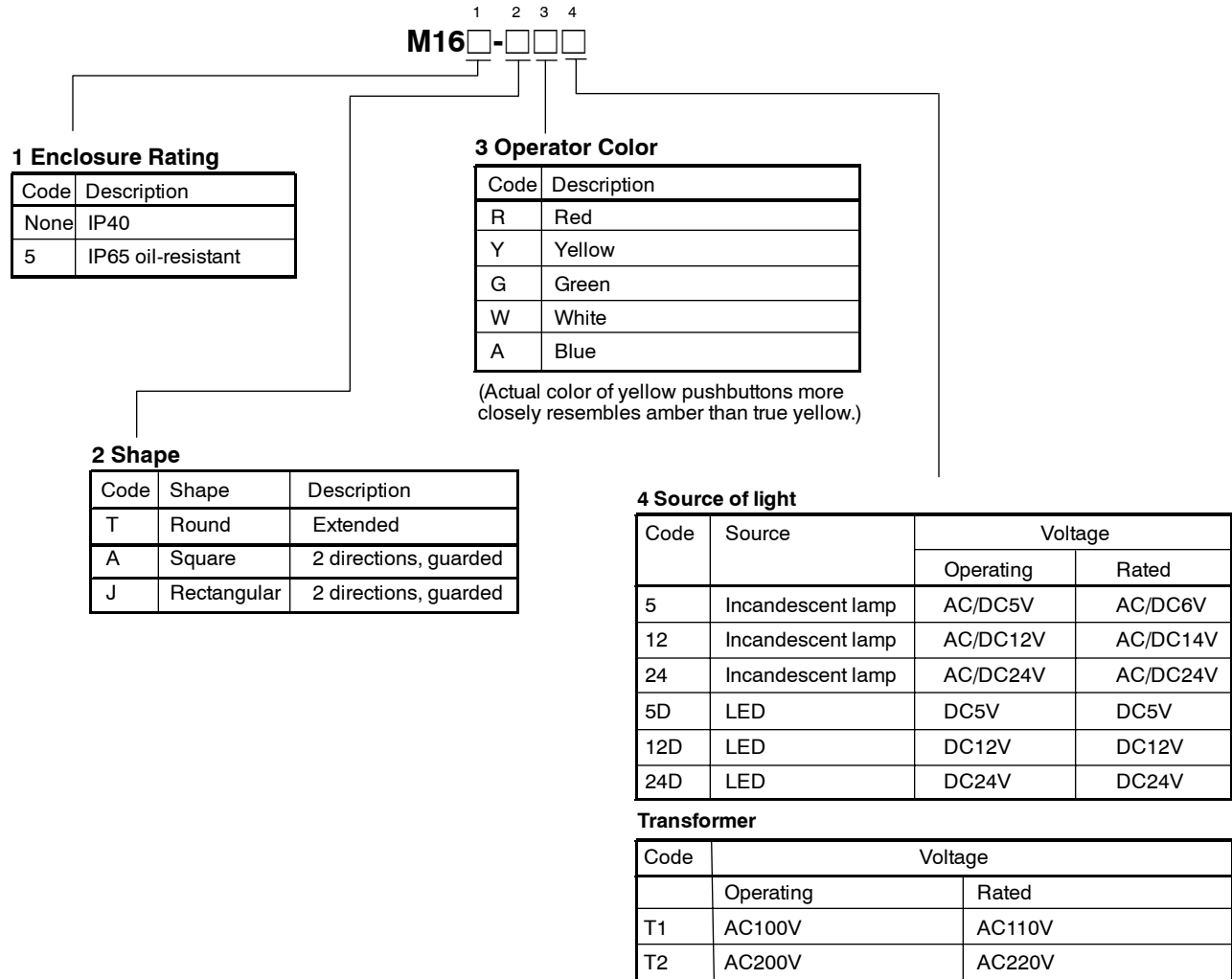

M16 Part number nomenclature



## ■ PART NUMBERS: PILOT LIGHTS (COMPLETE ASSEMBLY)

Style	Type	Voltage	Part number	
			IP40	IP65 Oiltight
Round 	Full voltage LED (DC)	5 VDC	M16-T□-5D	M165-T□-5D
		12 VDC	M16-T□-12D	M165-T□-12D
		24 VDC	M16-T□-24D	M165-T□-24D
	Full voltage incandescent lamp (AC/DC)	5 V AC/DC	M16-T□-5	M165-T□-5
		12 V AC/DC	M16-T□-12	M165-T□-12
		24 V AC/DC	M16-T□-24	M165-T□-24
	Transformer 24 V secondary	110 VAC	M16-T□-T1	M165-T□-T1
		220 VAC	M16-T□-T2	M165-T□-T2
	Square 	Full voltage LED (DC)	5 VDC	M16-A□-5D
12 VDC			M16-A□-12D	M165-A□-12D
24 VDC			M16-A□-24D	M165-A□-24D
Full voltage incandescent lamp (AC/DC)		5 V AC/DC	M16-A□-5	M165-A□-5
		12 V AC/DC	M16-A□-12	M165-A□-12
		24 V AC/DC	M16-A□-24	M165-A□-24
Transformer 24 V secondary		110 VAC	M16-A□-T1	M165-A□-T1
		220 VAC	M16-A□-T2	M165-A□-T2
Rectangular 		Full voltage LED (DC)	5 VDC	M16-J□-5D
	12 VDC		M16-J□-12D	M165-J□-12D
	24 VDC		M16-J□-24D	M165-J□-24D
	Full voltage incandescent lamp (AC/DC)	5 V AC/DC	M16-J□-5	M165-J□-5
		12 V AC/DC	M16-J□-12	M165-J□-12
		24 V AC/DC	M16-J□-24	M165-J□-24
	Transformer 24 V secondary	110 VAC	M16-J□-T1	M165-J□-T1
		220 VAC	M16-J□-T2	M165-J□-T2

Note: To complete part number, in place of the □ symbol, specify the color code from the Lens Color Code table below.

### Lens Color Codes

(Actual color of yellow lens more closely resembles amber than true yellow.)

Code	Color
R	Red
Y	Yellow
G	Green
W	White
A	Blue

■ PART NUMBER LEGEND A16 ILLUMINATED PUSHBUTTONS (COMPLETE ASSEMBLY)

Part Number Nomenclature

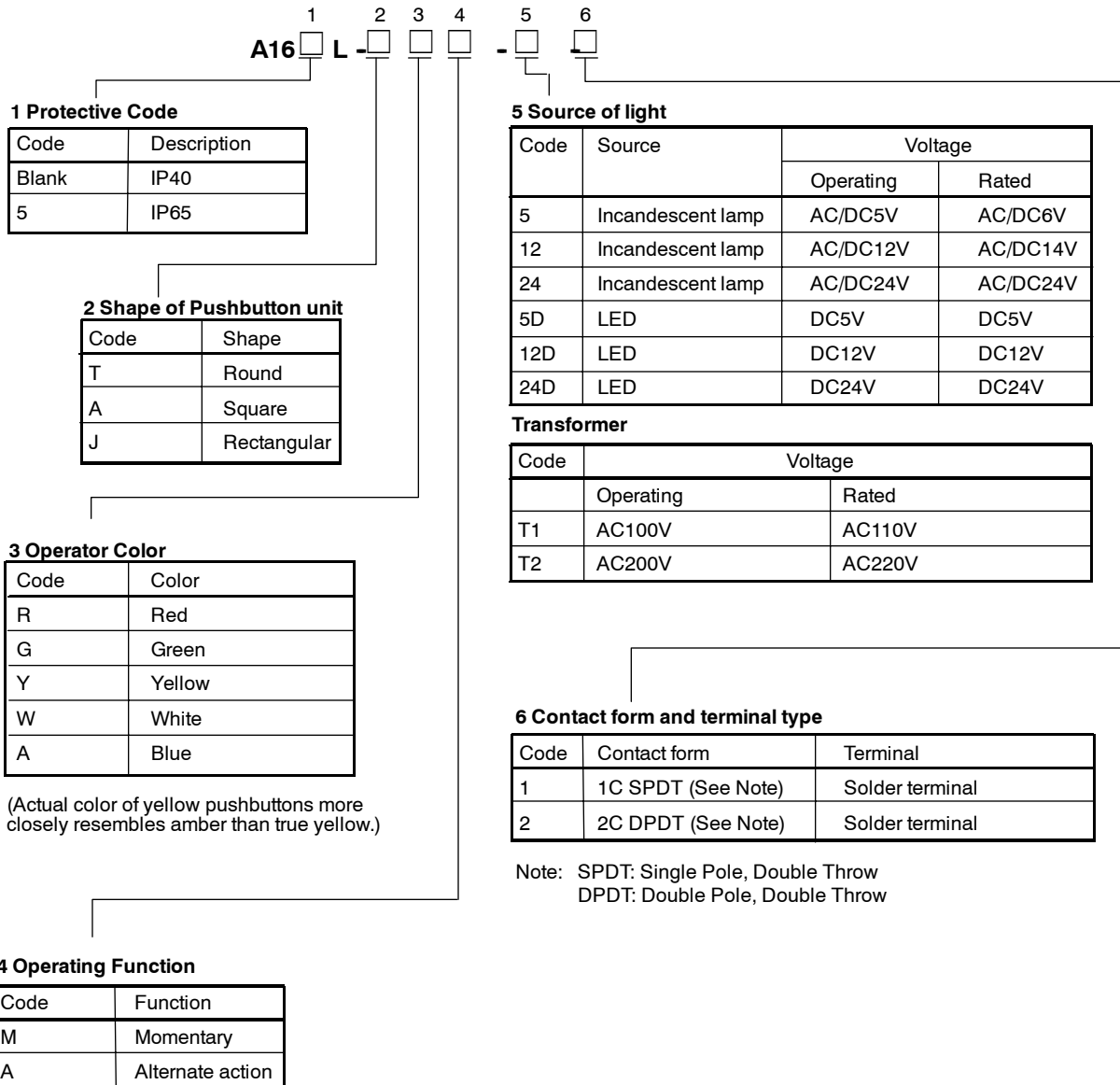

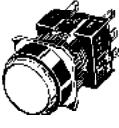
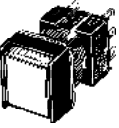
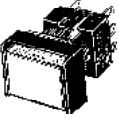

■ PART NUMBERS: A16 ILLUMINATED PUSHBUTTONS (COMPLETE ASSEMBLY)

Style	Illumination method	Voltage	Contact	Part number				
				Momentary		Alternate action		
				Enclosed (IP40)	Oight (IP65)	Enclosed (IP40)	Oight (IP65)	
	LED (DC)	5V	SPDT	A16L-T□M-5D-1	A165L-T□M-5D-1	A16L-T□A-5D-1	A165L-T□A-5D-1	
		12V		A16L-T□M-12D-1	A165L-T□M-12D-1	A16L-T□A-12D-1	A165L-T□A-12D-1	
		24V		A16L-T□M-24D-1	A165L-T□M-24D-1	A16L-T□A-24D-1	A165L-T□A-24D-1	
	Incandescent lamp (AC/DC)	5V		A16L-T□M-5-1	A165L-T□M-5-1	A16L-T□A-5-1	A165L-T□A-5-1	
		12V		A16L-T□M-12-1	A165L-T□M-12-1	A16L-T□A-12-1	A165L-T□A-12-1	
		24V		A16L-T□M-24-1	A165L-T□M-24-1	A16L-T□A-24-1	A165L-T□A-24-1	
	LED (DC)	5V		DPDT	A16L-T□M-5D-2	A165L-T□M-5D-2	A16L-T□A-5D-2	A165L-T□A-5D-2
		12V			A16L-T□M-12D-2	A165L-T□M-12D-2	A16L-T□A-12D-2	A165L-T□A-12D-2
		24V			A16L-T□M-24D-2	A165L-T□M-24D-2	A16L-T□A-24D-2	A165L-T□A-24D-2
	Incandescent lamp (AC/DC)	5V	A16L-T□M-5-2		A165L-T□M-5-2	A16L-T□A-5-2	A165L-T□A-5-2	
		12V	A16L-T□M-12-2		A165L-T□M-12-2	A16L-T□A-12-2	A165L-T□A-12-2	
		24V	A16L-T□M-24-2		A165L-T□M-24-2	A16L-T□A-24-2	A165L-T□A-24-2	
	LED (DC)	5V	SPDT		A16L-A□M-5D-1	A165L-A□M-5D-1	A16L-A□A-5D-1	A165L-A□A-5D-1
		12V			A16L-A□M-12D-1	A165L-A□M-12D-1	A16L-A□A-12D-1	A165L-A□A-12D-1
		24V			A16L-A□M-24D-1	A165L-A□M-24D-1	A16L-A□A-24D-1	A165L-A□A-24D-1
	Incandescent lamp (AC/DC)	5V		A16L-A□M-5-1	A165L-A□M-5-1	A16L-A□A-5-1	A165L-A□A-5-1	
		12V		A16L-A□M-12-1	A165L-A□M-12-1	A16L-A□A-12-1	A165L-A□A-12-1	
		24V		A16L-A□M-24-1	A165L-A□M-24-1	A16L-A□A-24-1	A165L-A□A-24-1	
	LED (DC)	5V		DPDT	A16L-A□M-5D-2	A165L-A□M-5D-2	A16L-A□A-5D-2	A165L-A□A-5D-2
		12V			A16L-A□M-12D-2	A165L-A□M-12D-2	A16L-A□A-12D-2	A165L-A□A-12D-2
		24V			A16L-A□M-24D-2	A165L-A□M-24D-2	A16L-A□A-24D-2	A165L-A□A-24D-2
	Incandescent lamp (AC/DC)	5V	A16L-A□M-5-2		A165L-A□M-5-2	A16L-A□A-5-2	A165L-A□A-5-2	
		12V	A16L-A□M-12-2		A165L-A□M-12-2	A16L-A□A-12-2	A165L-A□A-12-2	
		24V	A16L-A□M-24-2		A165L-A□M-24-2	A16L-A□A-24-2	A165L-A□A-24-2	
	LED (DC)	5V	SPDT		A16L-J□M-5D-1	A165L-J□M-5D-1	A16L-J□A-5D-1	A165L-J□A-5D-1
		12V			A16L-J□M-12D-1	A165L-J□M-12D-1	A16L-J□A-12D-1	A165L-J□A-12D-1
		24V			A16L-J□M-24D-1	A165L-J□M-24D-1	A16L-J□A-24D-1	A165L-J□A-24D-1
	Incandescent lamp (AC/DC)	5V		A16L-J□M-5-1	A165L-J□M-5-1	A16L-J□A-5-1	A165L-J□A-5-1	
		12V		A16L-J□M-12-1	A165L-J□M-12-1	A16L-J□A-12-1	A165L-J□A-12-1	
		24V		A16L-J□M-24-1	A165L-J□M-24-1	A16L-J□A-24-1	A165L-J□A-24-1	
	LED (DC)	5V		DPDT	A16L-J□M-5D-2	A165L-J□M-5D-2	A16L-J□A-5D-2	A165L-J□A-5D-2
		12V			A16L-J□M-12D-2	A165L-J□M-12D-2	A16L-J□A-12D-2	A165L-J□A-12D-2
		24V			A16L-J□M-24D-2	A165L-J□M-24D-2	A16L-J□A-24D-2	A165L-J□A-24D-2
	Incandescent lamp (AC/DC)	5V	A16L-J□M-5-2		A165L-J□M-5-2	A16L-J□A-5-2	A165L-J□A-5-2	
		12V	A16L-J□M-12-2		A165L-J□M-12-2	A16L-J□A-12-2	A165L-J□A-12-2	
		24V	A16L-J□M-24-2		A165L-J□M-24-2	A16L-J□A-24-2	A165L-J□A-24-2	

Note: To complete the part number, in place of the □ symbol, specify the color code from the Operator Color Code table below.



**Operator Color Codes**

(Actual color of yellow pushbuttons more closely resembles amber than true yellow.)





Code	Color
R	Red
Y	Yellow
G	Green
W	White
A	Blue

Note: 1. To order illuminated pushbutton with 110 VAC transformer, replace the voltage code (5, 12, 24, 5D, 12D, 24D) with T1 for 110V or T2 for 220V. The secondary voltage of the transformer is always 24V.



## ■ ACCESSORIES (ORDER SEPARATELY)

Name	Shape	Classification	Remarks	Part number
Switch guards		Rectangular	Cannot be used with the Dust Cover.	<b>A16ZJ-5050</b>
		Square and round		<b>A16ZA-5050</b>
Dust covers		Rectangular	Cannot be used with the Switch Cover.	<b>A3BJ-5060</b>
		Square		<b>A3BA-5060</b>
		Round		<b>A3BT-5060</b>
Panel plugs		Rectangular	Used for covering the panel cutouts for future panel expansion.	<b>A3BJ-3003</b>
		Square		<b>A3BA-3003</b>
		Round		<b>A3BT-3003</b>

## ■ REPLACEMENTS

Name	Shape	Classification	Remarks	Part number	
Legend panels		Rectangular	IP40	Opaque	<b>A16ZJ-5204</b>
				Transparent	<b>A16ZJ-5202</b>
			Oil-resistant IP65	Opaque	<b>A16ZJ-5204</b>
				Transparent	<b>A16ZJ-5203</b>
		Square	IP40	Opaque	<b>A16ZA-5204</b>
				Transparent	<b>A16ZA-5202</b>
			Oil-resistant IP65	Opaque	<b>A16ZA-5204</b>
				Transparent	<b>A16ZA-5203</b>
		Round	IP40	Opaque	<b>A16ZT-5204</b>
				Transparent	<b>A16ZT-5202</b>
			Oil-resistant IP65	Opaque	<b>A16ZT-5204</b>
				Transparent	<b>A16ZT-5203</b>
Color caps (for IP40)	Rectangular 	LED indicator/incandescent lamp/non-illuminated	White	<b>A16Z□-5001W</b>	
			Red	<b>A16Z□-5001R</b>	
			Yellow	<b>A16Z□-5001Y</b>	
		LED indicator	Green	<b>A16Z□-5001GY</b>	
			Incandescent lamp/non-illuminated	Blue	<b>A16Z□-5001A</b>
				Green	<b>A16Z□-5001G</b>
	Square 	Non-illuminated	Black	<b>A16Z□-5011B</b>	
			LED indicator/incandescent lamp/non-illuminated	White	<b>A16Z□-5101W</b>
				Red	<b>A16Z□-5101R</b>
		Yellow		<b>A16Z□-5101Y</b>	
		LED indicator	Green	<b>A16Z□-5101GY</b>	
			Incandescent lamp/non-illuminated	Blue	<b>A16Z□-5101A</b>
Green	<b>A16Z□-5101G</b>				
Round 	Non-illuminated	Black	<b>A16Z□-5111B</b>		

## ■ TOOLS

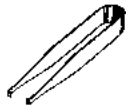
Name	Shape	Applicable types					Remarks	Part number
		Pushbutton Switch	Knob-type Selector Switch	Key-type Selector Switch	E-Stop Switch	Indicator		
Pushbutton switch extractor		Yes	No	No	No	Yes	Convenient for extracting Pushbutton Switches	<b>A3PJ-5080</b>
Screw fitting		Yes	Yes	Yes	Yes	Yes	Convenient for ganged installation. Tighten to a torque of 0.39 N • m (5 kgf • cm) min.	<b>A3B-3004</b>
Lamp unit extractor		Yes	Yes	Yes	Yes	Yes	Convenient for extracting the Switch Unit and Lamps.	<b>A16Z-5080</b>

## Specifications

### ■ CHARACTERISTICS

Item		
Allowable operating frequency	Mechanical	Momentary operation: 120 operations/min max. Alternating operation: 60 operations/min max. (See Note 1)
	Electrical	20 operations/min max.
Insulation resistance		100 MΩ min. (at 500 VDC)
Dielectric strength		1,000 VAC, 50/60 Hz for 1 min between terminals of same polarity 2,000 VAC, 50/60 Hz for 1 min between terminals of different polarity and also between each terminal and ground 1,000 VAC, 50/60 Hz for 1 min between lamp terminals (See Note 2)
Vibration resistance	Malfunction	10 to 55 Hz, 1.5-mm double amplitude (malfunction within 1 ms)
Shock resistance	Mechanical	500 m/s <sup>2</sup> (50G)
	Malfunction	150 m/s <sup>2</sup> (15G) max. (malfunction within 1 ms)
Life expectancy	Mechanical	Momentary operation: 2,000,000 operations min. Alternating operation: 200,000 operations min.
	Electrical	100,000 operations min.
Ambient temperature		Operating: -10°C to 55°C (14°F to 131°F) with no icing or condensation Storage: -25°C to 65°C (-13°F to 149°F) with no icing or condensation
Ambient humidity		Operating: 35% to 85%
Electric shock protection class		Class II
Degree of contamination		3 (IEC947-5-1)
Weight		Approx. 10 g (0.35 oz) in the case of a Illuminated DPDT switch with solder terminals

- Note: 1. Set and reset constitute one operation.  
2. With LED and incandescent lamp not mounted.

### ■ APPROVED STANDARDS

Recognized organization	Standards	File No.
UL, cUL (See Note)	UL508	E41515
ASTA	EN60947-5-1	—

Note: UL: CSA C22 No. 14

## ■ RATINGS

AC resistive load (AC15)	DC resistive load (DC13)
3 A, 250 VAC 5 A, 125 VAC	3 A, 30 VDC

Minimum applicable load: 1 mA at 5 VDC

Rated values are obtained from tests conducted under the following conditions according to JIS C4505 and C4520.

1. Load: Resistive load
2. Mounting conditions: No vibration and no shock
3. Temperature: 20°±2°C
4. Operating frequency: 20 operations/min

## Contact

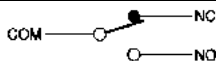
Name	Contact
SPDT	

## LED

Rated voltage	Rated current	Operating voltage	Internal limiting resistor
5 VDC	30 mA	5 VDC±5%	33 Ω
12 VDC	15 mA	12 VDC±5%	270 Ω
24 VDC	10 mA	24 VDC±5%	1600 Ω

## Incandescent Lamp

Rated voltage	Rated current	Operating voltage
6 VAC/DC	60 mA	5 VAC/DC
14 VAC/DC	40 mA	12 VAC/DC
28 VAC/DC	24 mA	24 VAC/DC

## ■ OPERATING CHARACTERISTICS

Type	Pushbutton Switch			
	IP40		Oil-resistant IP65	
	SPDT	DPDT	SPDT	DPDT
Operating force (OF) max.	2.45 N (250 gf)	4.41 N (450 gf)	2.94 N (300 gf)	4.91 N (500 gf)
Releasing force (RF) min.	0.29 N (30 gf)			
Total travel (TT)	Approx. 3 mm			
Pretravel (PT) max.	2.5 mm			
Lock stroke (LTA) min. (See Note)	0.5 mm			

Note: Lock stroke is only for alternating operation.

# Dimensions

Unit: mm (inch)

## ILLUMINATED/NON-ILLUMINATED PUSHBUTTON SWITCHES WITHOUT TRANSFORMER

The lamp terminal is also provided with non-Illuminated models.

Solder terminals and tab terminals (#110) can be both used with Illuminated and Non-Illuminated Pushbutton Switches.

### Rectangular A16□-J

Solder terminals (tab terminals #110)

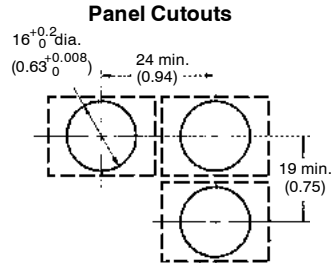
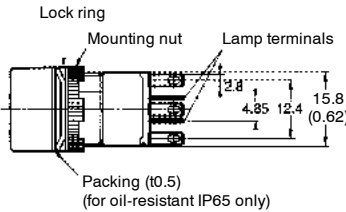
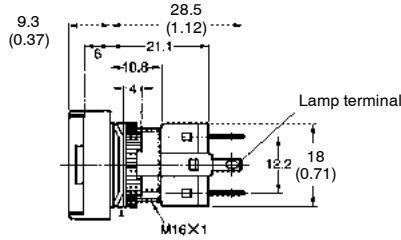
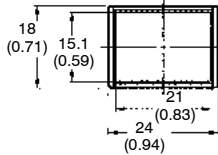
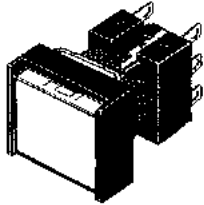

### Square A16□-A

Solder terminals (tab terminals #110)

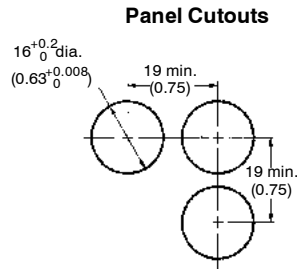
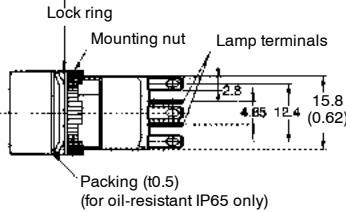
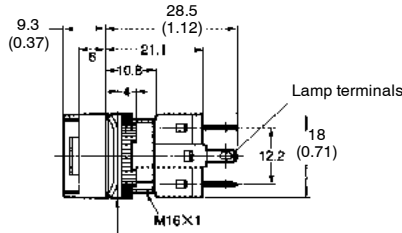
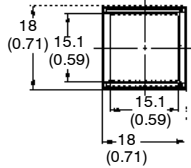
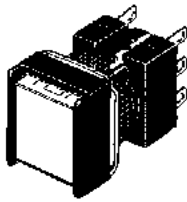

### Round A16□-T

Solder terminals (tab terminals #110)

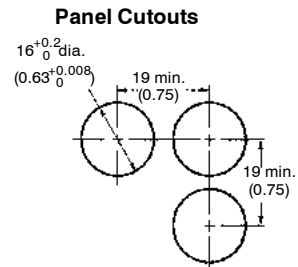
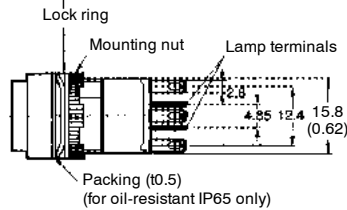
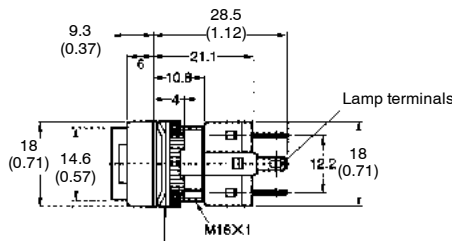
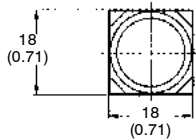
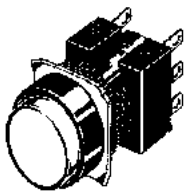

- Note: 1. Make sure the thickness of the mounting panel is between 0.5 and 3.2 mm. If, however, a Switch Guard or Dust Cover is used, the thickness of the mounting panel must be between 0.5 and 2 mm.  
2. If a panel is to be finished with coating, etc., make sure that the panel meets the specified dimensions after coating.

■ INDICATORS WITHOUT TRANSFORMER

**Rectangular  
M16-J**

Solder terminals (tab terminals #110)

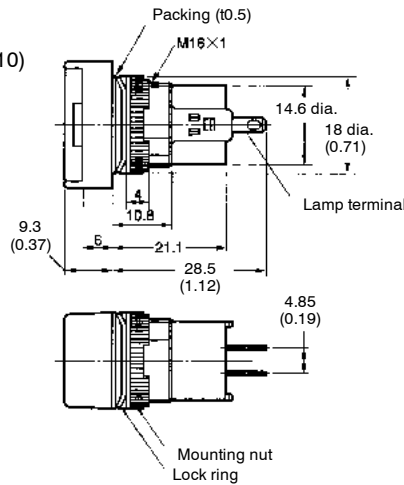
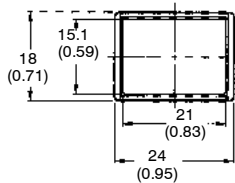

**Panel cutouts  
(Top View)**

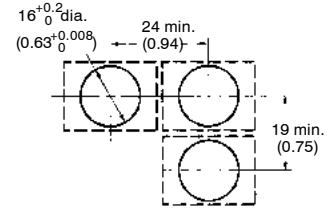

**Square  
M16-A**

Solder terminals (tab terminals #110)

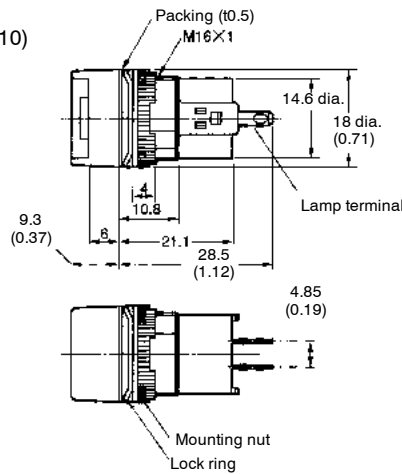
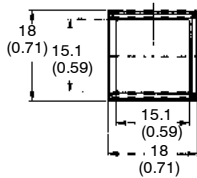

**Panel cutouts  
(Top View)**

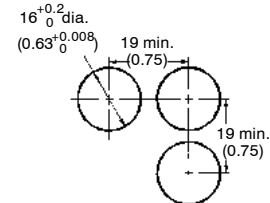

**Round  
M16-T**

Solder terminals (tab terminals #110)

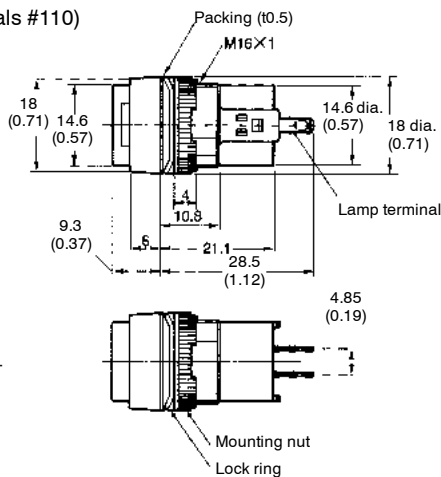
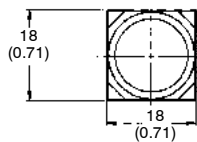

**Panel cutouts  
(Top View)**

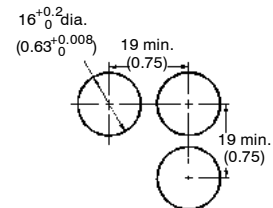

- Note: 1. Make sure the thickness of the mounting panel is between 0.5 and 3.2 mm. If, however, a Switch Guard or Dust Cover is used, the thickness of the mounting panel must be between 0.5 and 2 mm.  
2. If a panel is to be finished with coating, etc., make sure that the panel meets the specified dimensions after coating.

Unit: mm (inch)

**LAMPS**

**LED**

A16-5D□/-12D□/-24D□

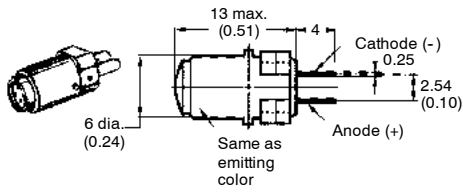

**Incandescent Lamp**

A16-5/-12/-24

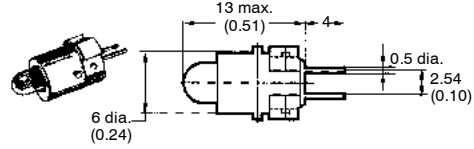

**TERMINAL ARRANGEMENT**

Non-Illuminated Pushbutton Switches are also provided with lamp terminals.

**SPDT Switches**

Illuminated type

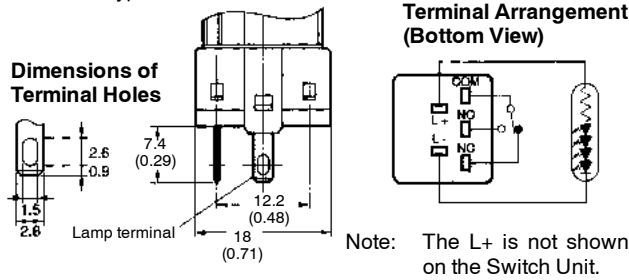

**DPDT Switches**

Illuminated type

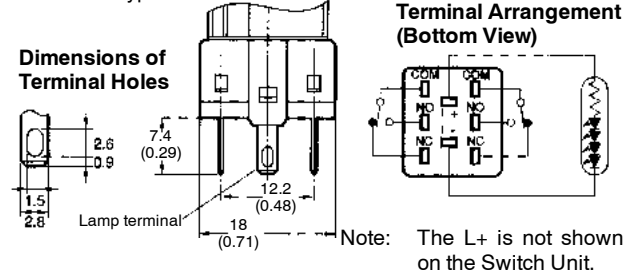

**Pilot lights**

Dimensions of Terminal Holes

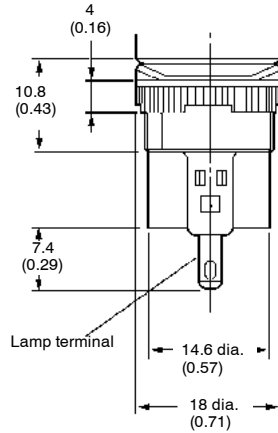
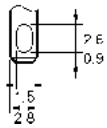

Terminal Arrangement (Bottom View)

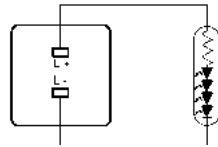

Note: The L+ is not shown on the Switch Unit.

■ ACCESSORIES, TOOLS, AND COMPONENTS

**Pushbutton switch extractor  
A3PJ-5080**

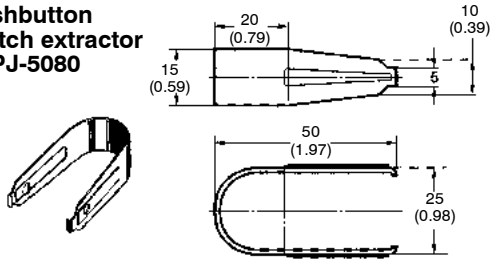

**Legend Panels  
A16ZJ-520□**

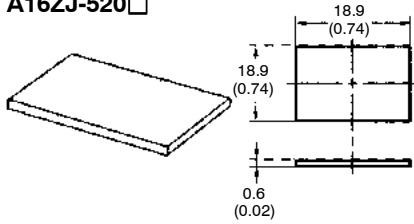

**A16ZA-520□**

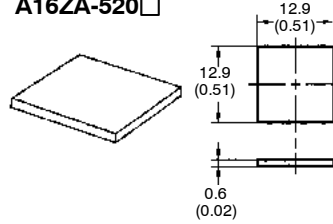

**A16ZT-520□**

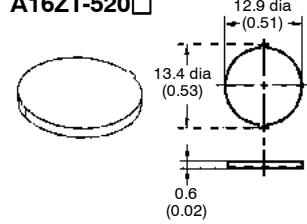

- Note: 1. The panel is 0.6 mm thick.  
2. The panel is made of the materials listed in the following table.

Color	Degree of protection	Materials
Opaque	IP40	Polyacrylate resin
	IP65	
Transparent	IP40	Polycarbonate resin
	IP65	Polyacrylate resin

Note: The standard model is transparent.

**Screw Fitting  
A3B-3004**

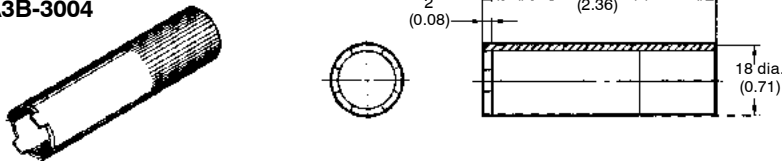

**Panel Plugs (Black Resin)**

Select the Plug that fits the panel design and mount from the front of the Panel. Panel cutouts are the same as those for Switches.

**Rectangular  
A3BJ-3003**

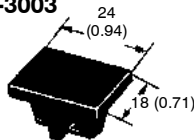

**Square  
A3BA-3003**

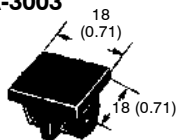

**Round  
A3BT-3003**





Lock Fitting

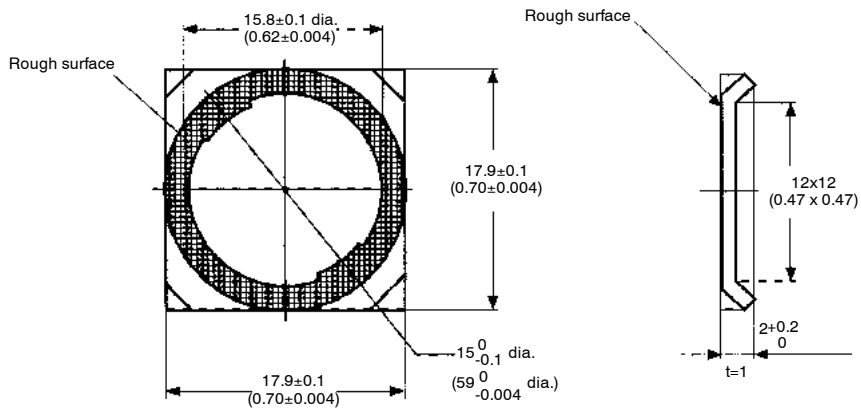

Lamp unit extractor  
A16Z-5080

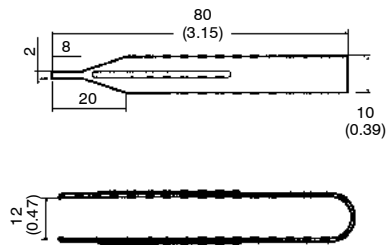
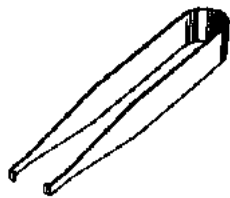

# Dimensions When Mounting Accessories

Unit: mm (inch)

## SWITCH GUARDS

### Rectangular A16ZJ-5050

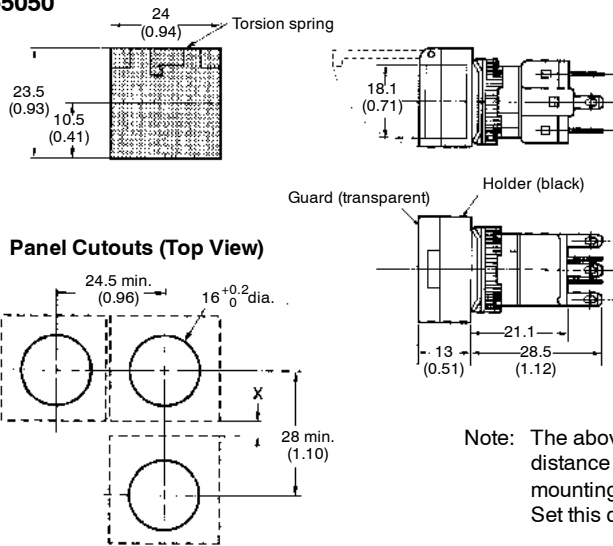

Note: The above illustration shows a case where 4.5 mm is provided for the distance "x." If no clearance is required for the "x" section, the vertical mounting dimension can be as small as 24 mm. Set this distance according to operating conditions.

### Square A16ZA-5050

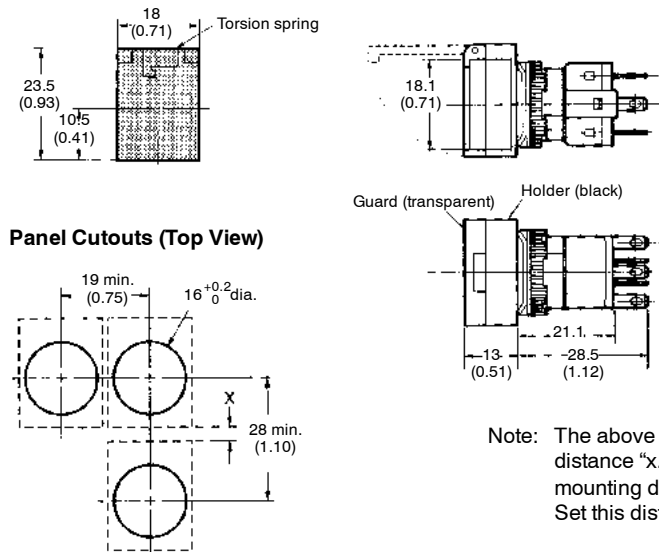

Note: The above illustration shows a case where 4.5 mm is provided for the distance "x." If no clearance is required for the "x" section, the vertical mounting dimension can be as small as 24 mm. Set this distance according to operating conditions.

■ DUST COVERS

**Rectangular  
A3BJ-5060**

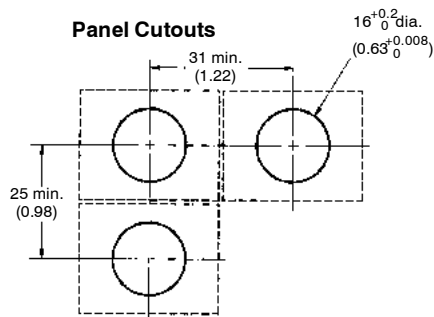
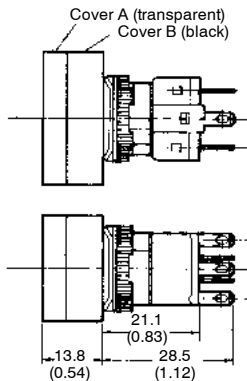
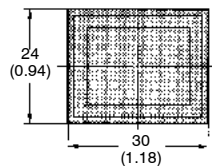

**Square  
A3BA-5060**

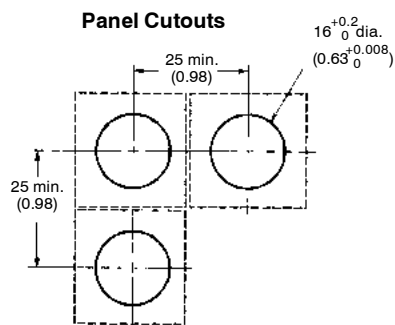
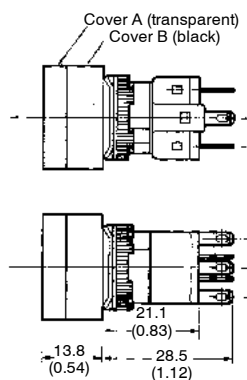
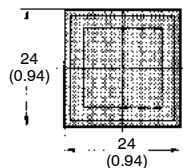

**Round  
A16ZT-5050**

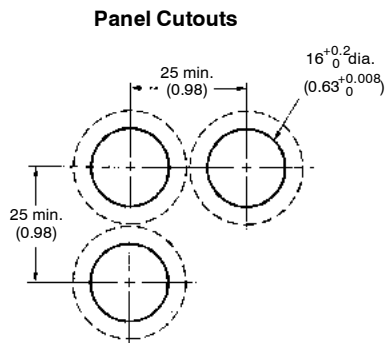
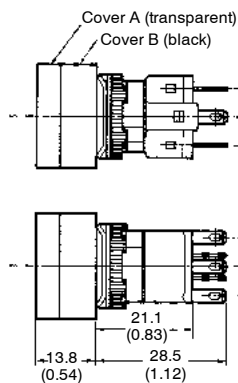

# Installation

## ■ MOUNTING

After mounting the Pushbutton Unit to the panel, snap in the Socket Unit from the back of the panel.

### Panel mounting

Insert the Pushbutton Unit into the front of the panel, and fix the lock ring and mounting nut from the terminal side.

Make sure that the lock ring is aligned with the thread of the case and the edge of the lock ring is touching the panel.

Tighten the mounting nuts to a torque of 0.20 to 0.39 N · m (3 to 5 kgf · cm).

The maximum tightening torque is 0.39 N · m (5 kgf · cm).

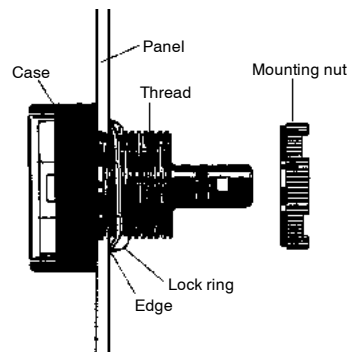

### Switch Mounting

Snap on the Switch Unit to the Pushbutton Unit.

Make sure the the Switch Unit is in the proper orientation when snapping on to the Pushbutton Unit.

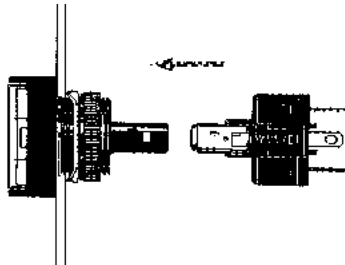

## ■ SWITCH REMOVAL

Grip the part between the Switch holder of the case and the Switch Unit using the A16Z-5080 Extractor, and pull to remove the Switch Unit.

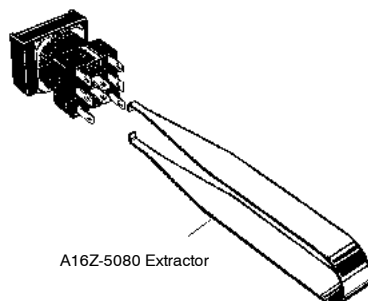

## ■ REPLACEMENT PARTS

### Removal and installation of the Operating Part

1. Remove the operating part as shown in the following diagram. If the operating part cannot be removed by hand, use the A3PJ-5080 Extractor.

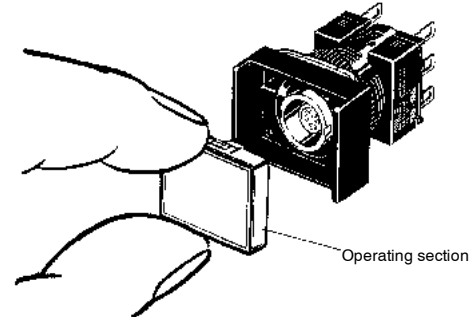

2. To attach the operating part, push until it clicks into place.

## ■ REMOVING THE LAMP

### Removing from the Operating Part End

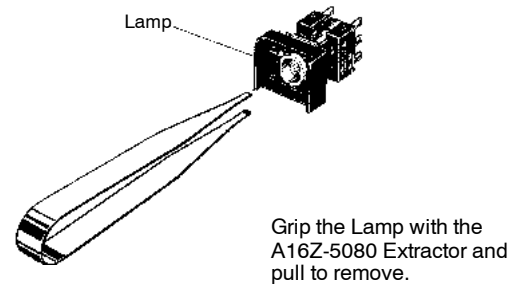

### Removing from the Switch Unit End

The Lamp can be removed by hand once the Switch is removed using the A16Z-5080 Extractor.

## ■ INSTALLING THE LAMP

When mounting the Lamp, make sure it is facing the direction shown in the following diagram. Insert the Lamp while matching the protruding part of the Lamp and the small guides on the outer surface of the case.

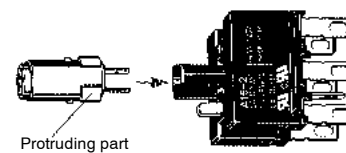

The Lamp can be mounted from the operating part end by using the A16Z-5080 Extractor. The lamp can be mounted by following the opposite procedure for removing the Lamp.

# Precautions

## ! WARNING

Do not apply a voltage between the incandescent lamp and the terminal that is greater than the rated voltage. If the incandescent lamp is broken, the operating part may pop out.

Always turn OFF the power and wait for 10 minutes before replacing the incandescent lamp. If the lamp is replaced immediately after the power is turned OFF, the remaining heat may cause burns.

## ■ CORRECT USE

### Mounting

Always make sure that the power is turned OFF before mounting, removing, or wiring the Switch, or performing maintenance.

Do not tighten the mounting nut more than necessary using tools such as pointed-nose pliers. Doing so will damage the mounting nut. The tightening torque is 0.20 to 0.39 N • m (3 to 5 kgf • cm).

### Wiring

Solder terminals and quick-connect terminals (#110) are commonly used for terminals.

Be sure to use electrical wires that are a size appropriate for the applied voltage and carry current (conductor size is 0.5 to 0.75 mm<sup>2</sup>). Perform soldering according to the conditions provided below. If the soldering is not properly performed, the lead wires will become detached, resulting in short-circuits.

1. Hand soldering: 30 W, within 5 s
2. Dip soldering: 240°C, within 3 s

Wait for one minute after soldering before exerting any external force on the solder.

Use non-corrosive resin fluid as the flux.

Make sure that the electric cord is wired so that it does not touch the Unit. If the electric cord will touch the Unit, then electric wires with a heat resistance of 100°C min. must be used.

After wiring the Switch, maintain an appropriate clearance and creepage distance.

### Operating Environment

The IP65 model is designed with a protective structure so that it will not sustain damage if it is subjected to water from any direction to the front of the panel.

### Using the Microload

Insert a contact protection circuit, if necessary, to prevent the reduction of life expectancy due to extreme wear on the contacts caused by loads where inrush current occurs when the contact is opened and closed.

The A16 allows both a general-purpose load (125 V at 5A, 250 V at 3 A) and a microload. If a general-purpose load is applied, however, the microload area cannot be used. If the microload area is used with a general-purpose load, the contact surface will become rough, and the opening and closing of the contact for a microload may become unreliable.

The minimum applicable load is the N-level reference value. This value indicates the malfunction reference level for the reliability level of 60% ( $\lambda$  60) (conforming to JIS C5003).

The equation,  $\lambda$  60 =  $0.5 \times 10^{-4}$ /time indicates that the estimated malfunction rate is less than 1/2,000,000 with a reliability level of 60%.

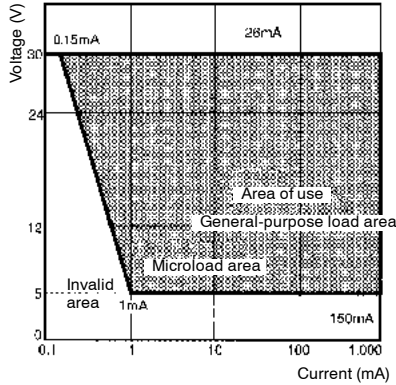

### LEDs

The LED current-limiting resistor is built-in, so internal resistance is not required.

Rated voltage	Internal limiting resistor
5 VDC	33 $\Omega$
12 VDC	270 $\Omega$
24 VDC	1600 $\Omega$

### Others

The oil-resistant IP65 uses NBR rubber and is resistant to general cutting oil and cooling oil. Some particular oils cannot be used with the oil-resistant IP65, however, so contact your OMRON representative for details.

If the panel is to be finished with coating, etc., make sure that the panel meets the specified dimensions after the coating.

Do not subject the Switch to extreme shock or vibration. Doing so will cause malfunctions and damage to the Switch.

Do not let sharp objects come into contact with the Switches that are made of resin. Doing so will damage the Switches, causing scratches on the outside of the operating parts, and malfunction.

When handling the Switches, do not throw or drop them.

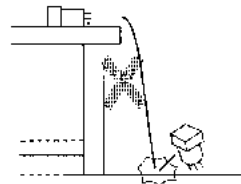

Do not allow the Switch to drop and hit the ground.

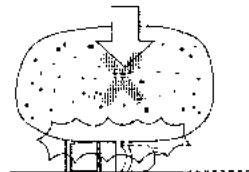

Do not place or drop heavy objects on the Switch.

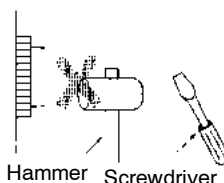

Do not operate the Switch with hard or sharp objects.

**NOTE: DIMENSIONS SHOWN ARE IN MILLIMETERS. To convert millimeters to inches divide by 25.4.**

**OMRON**<sup>®</sup>

**OMRON ELECTRONICS LLC**

One East Commerce Drive  
Schaumburg, IL 60173

**1-800-55-OMRON**

**OMRON ON-LINE**

Global - <http://www.omron.com>

USA - <http://www.omron.com/oei>

Canada - <http://www.omron.com/oci>

**OMRON CANADA, INC.**

885 Milner Avenue  
Scarborough, Ontario M1B 5V8

**416-286-6465**