

**BACKSHELL KIT INCLUDES:**

- 1 - BACKSHELL ⑤
- 1 - ALIGNMENT SLEEVE ①
- 1 - COVER ②
- 1 - INSULATOR (FRONT) ③
- 1 - INSULATOR (REAR) ④
- 2 - 2-56 JACKSCREW ⑥

**MATERIAL:**

- BACKSHELL: THERMOPLASTIC
- ALIGNMENT SLEEVE: STEEL, TIN PLATED
- COVER: STEEL, TIN PLATED
- INSULATOR (FRONT): THERMOPLASTIC
- INSULATOR (REAR): THERMOPLASTIC
- JACKSCREW: STEEL, NICKEL PLATED

960-YYY-010R01Y

1 = KIT  
2 = BULK

009 = 9 POSITION  
015 = 15 POSITION  
025 = 25 POSITION

DIMENSIONS					
No. OF PINS	A	B	C	D MAX	E
9	0.780	1.350	0.395	0.228	0.338
	19.81	34.29	10.03	5.79	8.59
15	0.932	1.367	0.360	0.284	0.338
	23.67	34.72	9.14	7.21	8.59
25	1.195	1.373	0.390	0.331	0.390
	30.35	34.87	9.91	8.41	9.91

**DO NOT SCALE FROM DRAWING**

	THESE DRAWINGS AND SPECIFICATIONS ARE THE PROPERTY OF NorComp AND SHALL NOT BE REPRODUCED, COPIED OR USED AS THE BASIS FOR THE MANUFACTURE OF SALE OF APPARATUS WITHOUT WRITTEN PERMISSION.		DRAWN: M. SIGMON	DATE: 09-01-11
			CHECKED:	DATE:
<b>NorComp</b>		SCALE: 2 : 1	SHEET 1 OF 2	REV 1
		DWG NO. 960-YYY-010R01Y		

**RoHS COMPLIANT**

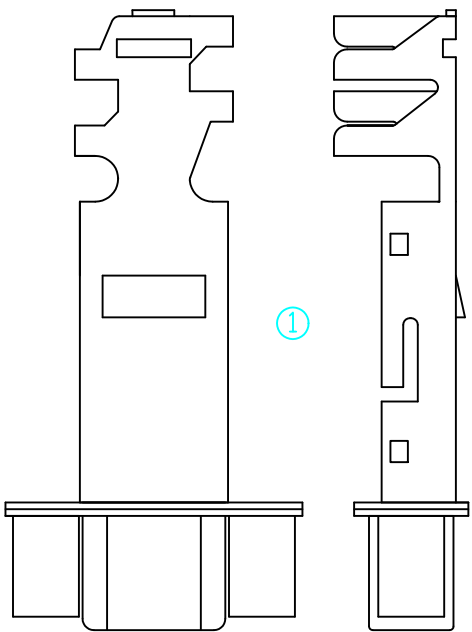

ALIGNMENT SLEEVE  
(LOWER SHIELD)

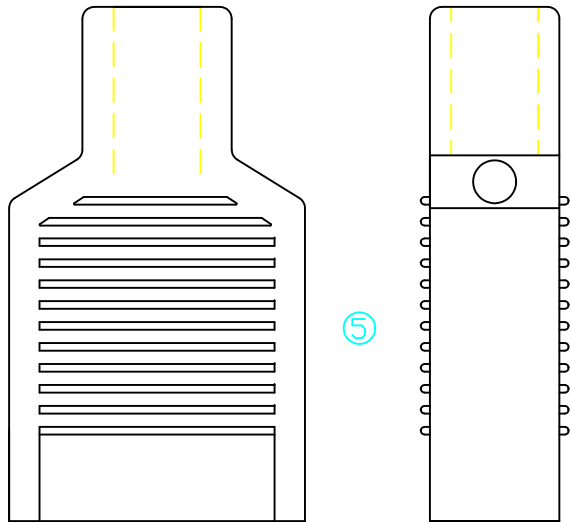

BACKSHELL

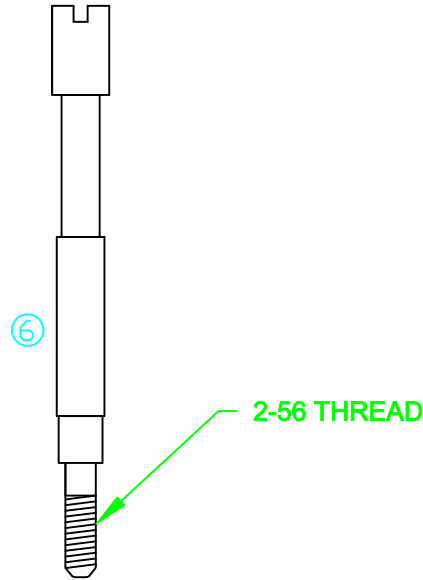

JACKSCREW(2)

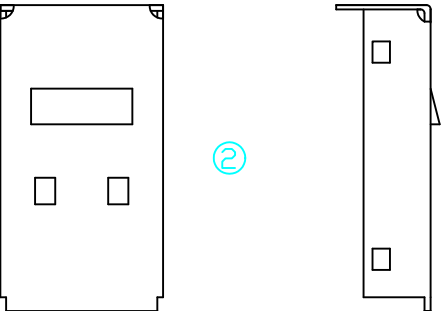

COVER (UPPER SHIELD)

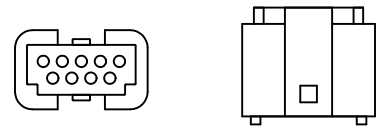

INSULATOR (FRONT)

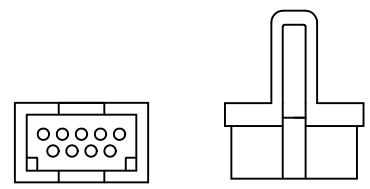

INSULATOR (REAR)

DO NOT SCALE FROM DRAWING

	THESE DRAWINGS AND SPECIFICATIONS ARE THE PROPERTY OF NorComp AND SHALL NOT BE REPRODUCED, COPIED OR USED AS THE BASIS FOR THE MANUFACTURE OF SALE OF APPARATUS WITHOUT WRITTEN PERMISSION.		DRAWN: <b>M. SIGMON</b>	DATE: <b>09-01-11</b>
			CHECKED:	DATE:
NorComp		SCALE: 2 : 1	SHEET 2 OF 2	REV 1
		DWG NO. <b>960-YYY-010R01Y</b>		

RoHS COMPLIANT