

SINGLE-SUPPLY DUAL COMPARATOR

■ GENERAL DESCRIPTION

The NJM2903C / NJM2903CA consist of two independent voltage comparators that are designed specifically to operate from a single power supply over a wide range of voltages. Operation from split power supplies is also possible and the low power supply current drain is independent of the magnitude of the power supply voltage.

The NJM2903C / NJM2903CA has a unique characteristic: the input common-mode voltage range includes ground, even though operated from a single power supply voltage.

Application areas include limit comparators, simple analog-to-digital converters; pulse, square-wave and time delay generators; wide range V_{CO} ; MOS clock timers; multivibrators and high voltage digital logic gates. The NJM2903C / NJM2903CA were designed to directly interface with TTL and MOS. When operated from both plus and minus power supplies, the NJM2903C / NJM2903CA will directly interface with MOS logic where their low power drain is a distinct advantage over standard comparators

■ FEATURES

- Operating Voltage +2V to +36V
- Single Supply Operation
- Open Collector Output
- Package Outline SOP8, DMP8, SSOP8, EQFN14-D7
MSOP8 (TVSP8)*MEET JEDEC MO-187-DA/ THIN TYPE
- Bipolar Technology
- Internal ESD protection Human body model (HBM) $\pm 2000V$ typ.
- Wide temperature range $-40^{\circ}C$ to $+125^{\circ}C$
- Input Offset Voltage Grade

NJM2903C(Normal-Grade)	NJM2903CA(A-Grade)
5mV max.	2mV max.

* NJM2903CMD7 don't have a A version.

■ PIN CONFIGURATION

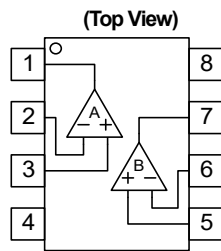

NJM2903CG / NJM2903CAG
 NJM2903CM / NJM2903CAM
 NJM2903CRB1 / NJM2903CARB1
 NJM2903CV / NJM2903CAV

PIN FUNCTION
 1.A OUTPUT
 2.A -INPUT
 3.A +INPUT
 4.V⁺
 5.B +INPUT
 6.B -INPUT
 7.B OUTPUT
 8.V⁺

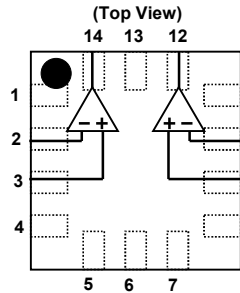

NJM2903CMD7 (Note1, 2, 3)

- (Note1) The NF pin, NC pin and The PAD have to be wired as short as possible to connect with a V⁻ pin.
 (Note2) The NF pin and The PAD are electronically connected to the backside of the die. But, there cannot be used as V⁻ pin.
 (Note3) The NC pin is not internally connected.

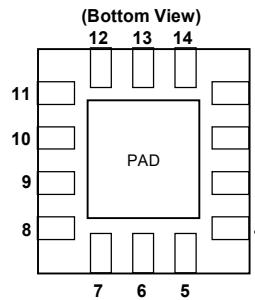

PIN FUNCTION
 1. NF(No Function)
 2. A -INPUT
 3. A +INPUT
 4. NF(No Function)
 5. NC
 6. V⁻
 7. NC
 8. NF(No Function)
 9. B +INPUT
 10. B -INPUT
 11. NF(No Function)
 12. B OUTPUT
 13. V⁺
 14. A OUTPUT

■ EQUIVALENT CIRCUIT (1/2 Shown)

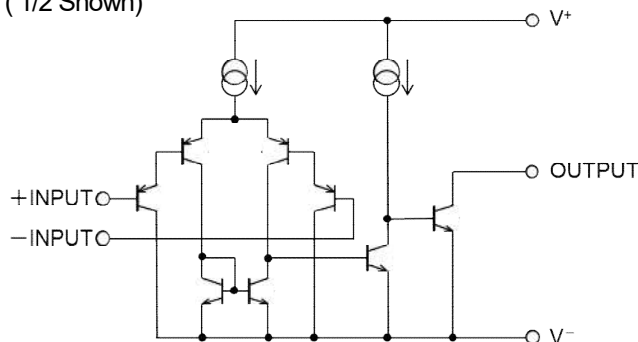

New Japan Radio Co., Ltd.

NJM2903C / NJM2903CA

■ ABSOLUTE MAXIMUM RATINGS

(Ta=25°C)

PARAMETER	SYMBOL	RATINGS	UNIT
Supply Voltage	$V^+ - V^-$	+36	V
Differential Input Voltage (Note4)	V_{ID}	±36	V
Input Voltage (Note5)	V_{IN}	$V^- - 0.3$ to $V^+ + 36$	V
Output Terminal Input Voltage (Note6)	V_O	$V^- - 0.3$ to $V^+ + 36$	V
Power Dissipation	P_D	SOP : 690 (Note7) 1000 (Note8) DMP : 470 (Note7) 600 (Note8) MSOP : 510 (Note7) 680 (Note8) SSOP : 430 (Note7) 540 (Note8) EQFN : 440 (Note7) 770 (Note8)	mW
Operating Temperature Range	T_{opr}	-40 to +125	°C
Storage Temperature Range	T_{stg}	-65 to +150	°C

(Note4) Differential voltage is the voltage difference between +INPUT and -INPUT.

(Note5) Input voltage is the voltage should be allowed to apply to the input terminal independent of the magnitude of V^+

(Note6) Output voltage is the voltage should be allowed to apply to the output terminal independent of the magnitude of V^+ .

(Note7) EIA/JEDEC STANDARD Test board (76.2 x 114.3 x 1.6mm, 2layers, FR-4) mounting

(Note8) EIA/JEDEC STANDARD Test board (76.2 x 114.3 x 1.6mm, 4layers, FR-4) mounting

■ ELECTRICAL CHARACTERISTICS

($V^+=5V, V^-=0V, Ta=25^\circ C$ unless otherwise noted.)

PARAMETER	SYMBOL	TEST CONDITION	MIN.	TYP.	MAX.	UNIT
Input Offset Voltage	V_{IO}	$R_S=0\Omega, V_O=1.4V$ $R_S=0\Omega, V_O=1.4V, NJM2903CA$	-	0.5 0.5	5 2	mV
Input Offset Current	I_{IO}		-	0.5	50	nA
Input Bias Current	I_B		-	20	250	nA
Large Signal Voltage Gain	A_V	$V^+=15V, R_L=15k\Omega, V_O=1V$ to 11V	94	106	-	dB
Common Mode Input Voltage Range	V_{ICM}		0	-	3.5	V
Supply Current (all comparators)	I_{SUPPLY}	no load $V^+=+30V$, no load	-	0.45 0.6	1 2.5	mA
Low-level Output Voltage	V_{OL}	$V_{IN+}=0V, V_{IN-}=1V, I_{SINK}=4mA$	-	80	400	mV
Output Leakage Current	I_{LEAK}	$V^+=V_O=30V, V_{IN+}=1V, V_{IN-}=0V$	-	-	1	μA
Output Sink Current	I_{SINK}	$V_{IN+}=0V, V_{IN-}=1V, V_O=1.5V$	6	16	-	mA
Response Time	t_{re}	$R_L=5.1k\Omega$ to V^+	-	1.3	-	μs
Large Signal Response Time	t_{rel}	$R_L=5.1k\Omega$ to V^+ , $V_{ref}=+1.4V$, TTL input	-	250	-	ns

■ TYPICAL CHARACTERISTICS

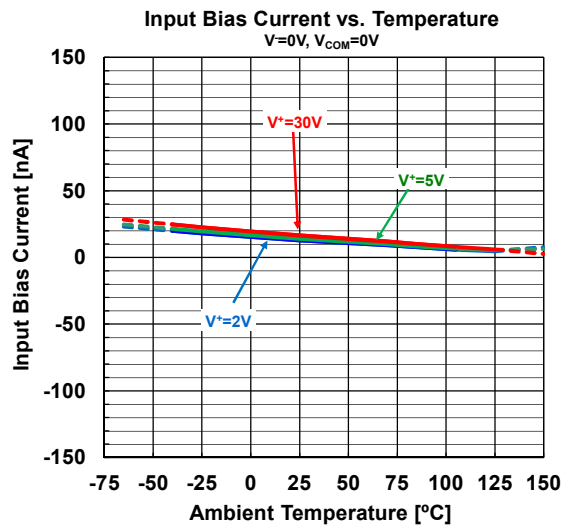
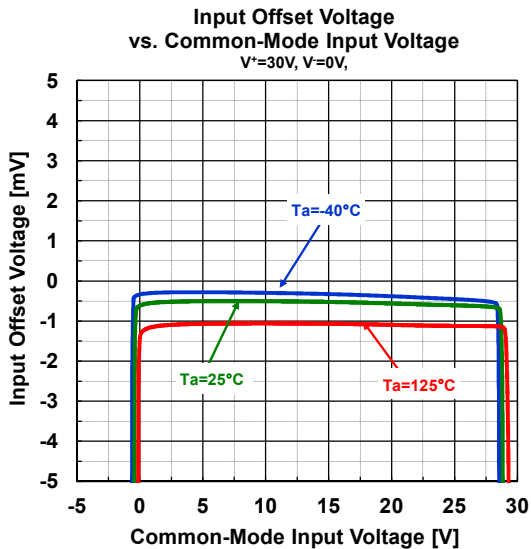
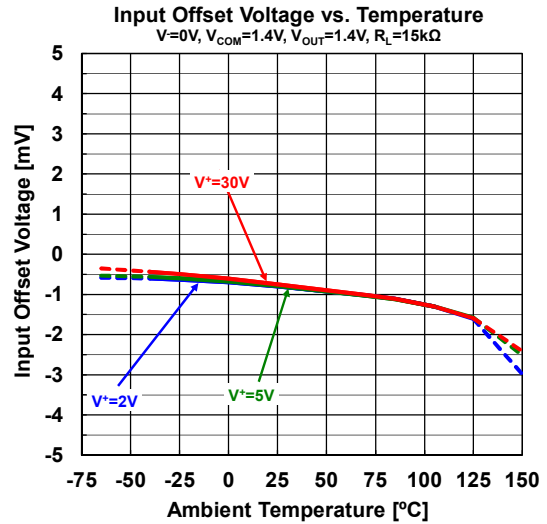
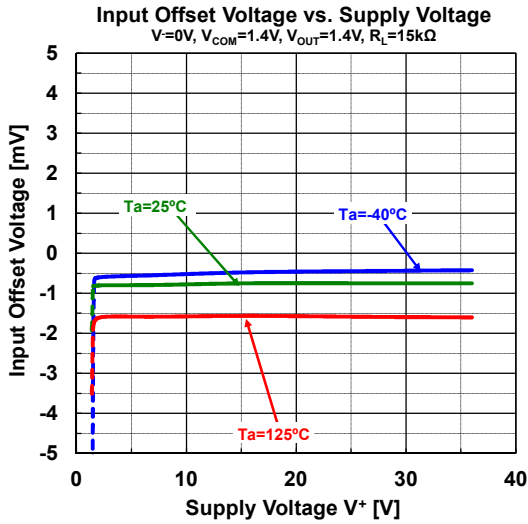
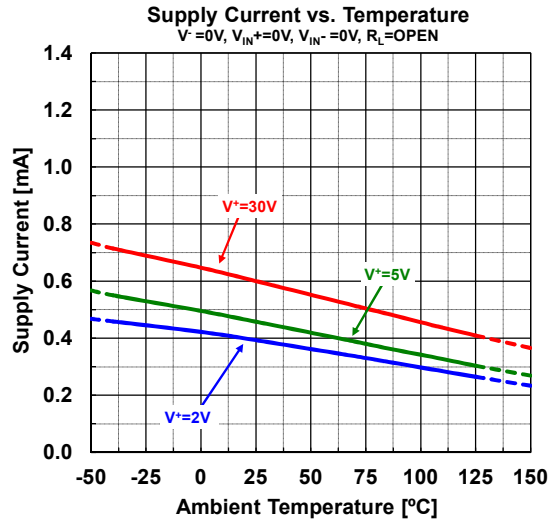
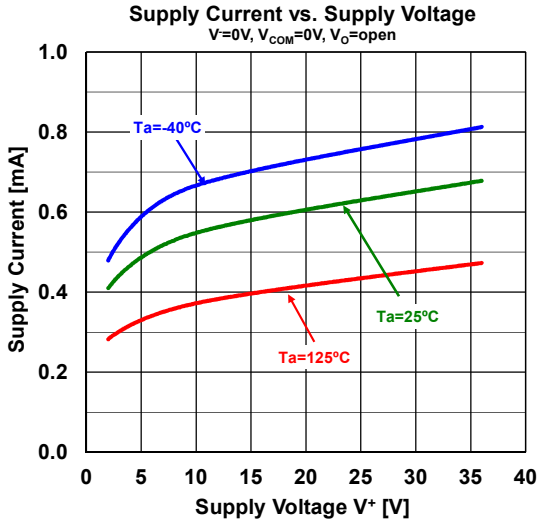

NJM2903C / NJM2903CA

TYPICAL CHARACTERISTICS

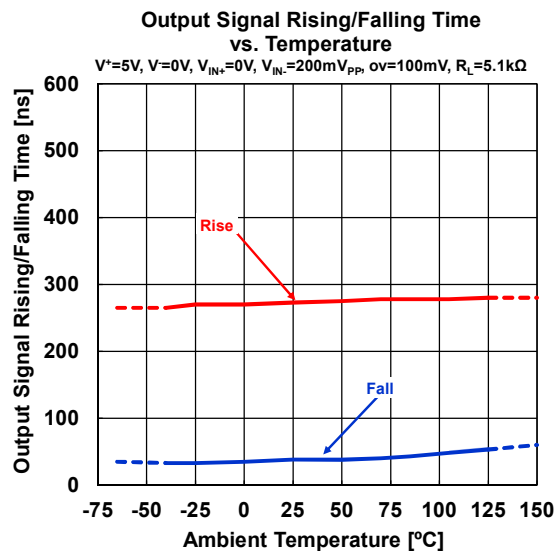
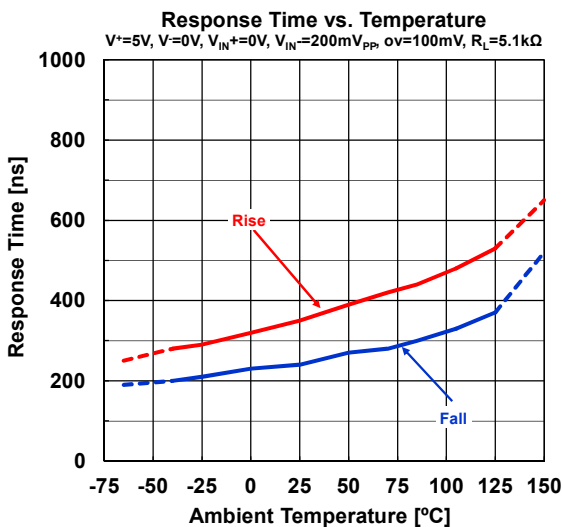
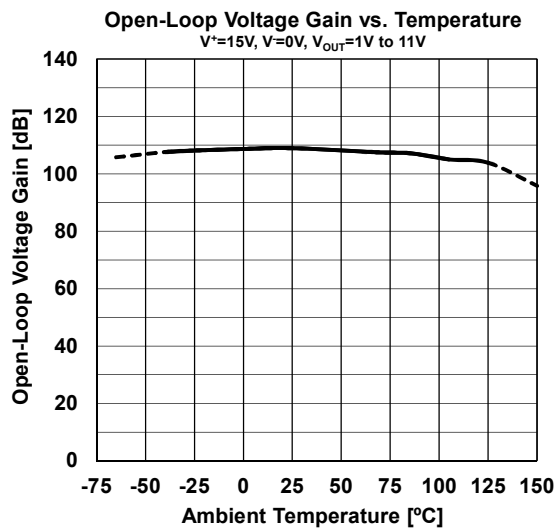
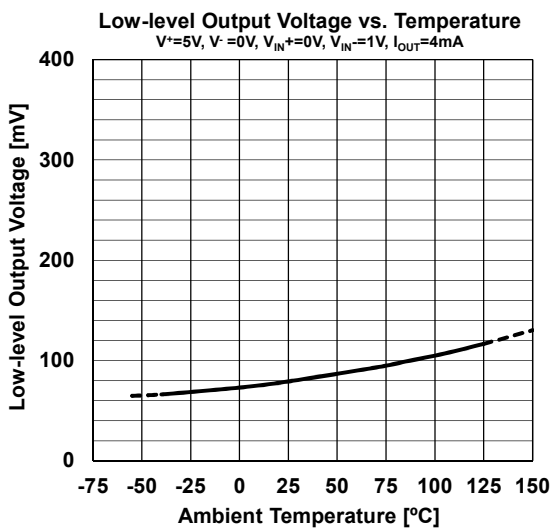
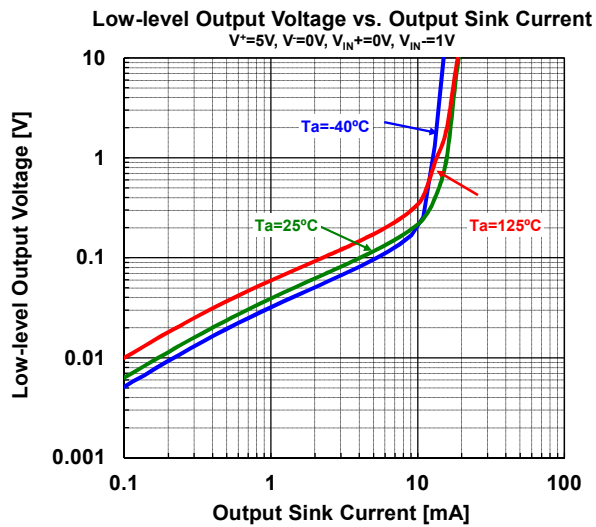
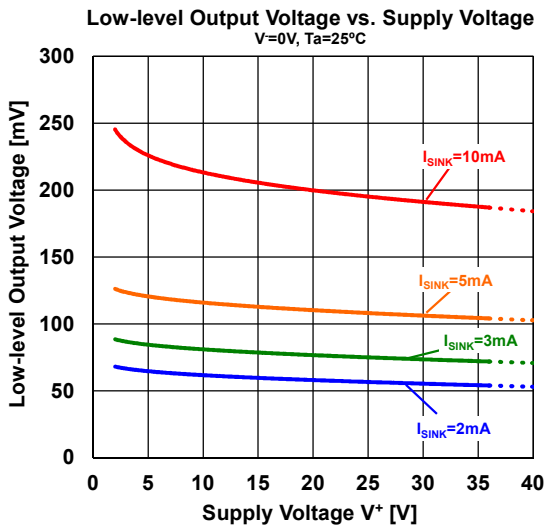

■ TYPICAL CHARACTERISTICS

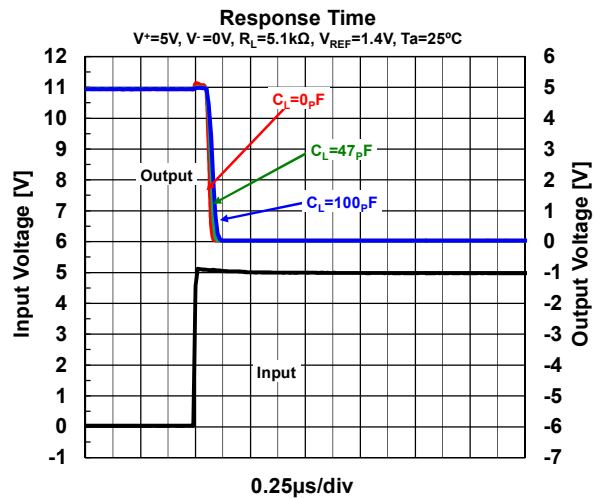
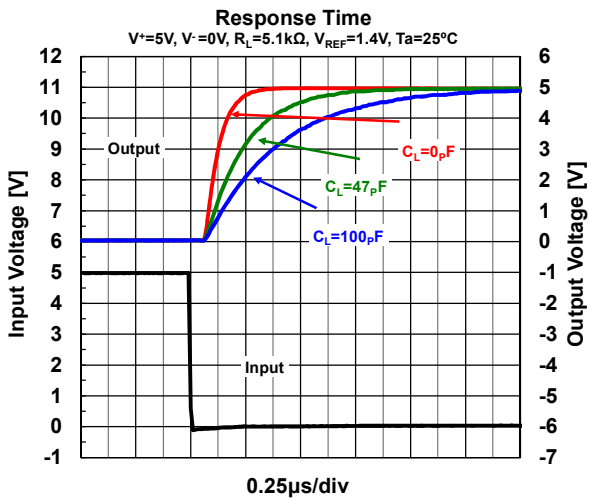
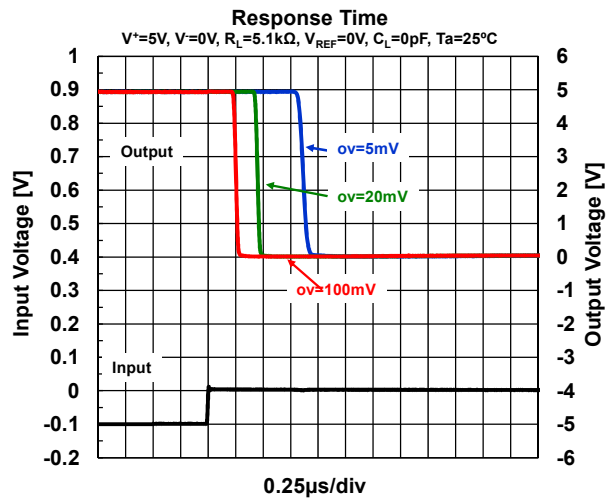
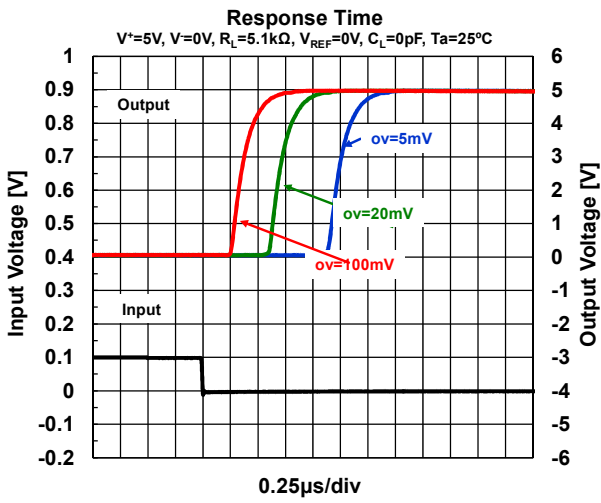

■ TYPICAL APPLICATIONS

Comparator With Hysteresis

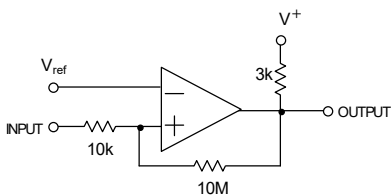

Pulse Generator

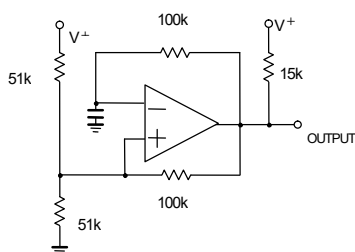

Output Strobing Circuit

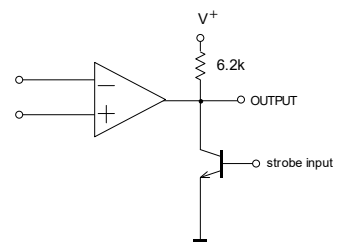

NJM2903C / NJM2903CA

■PACKAGE OUTLINE UNIT : mm
SOP8

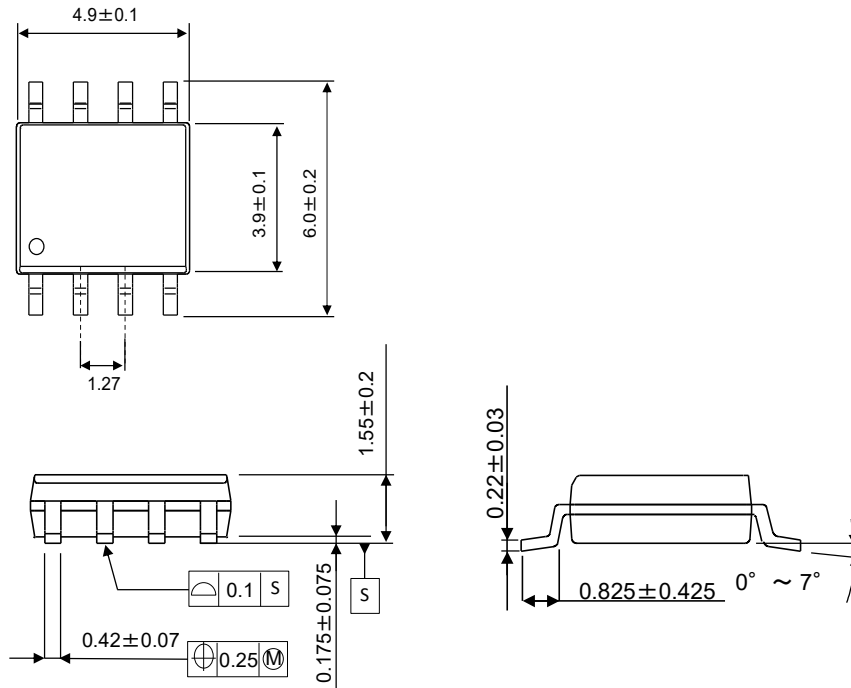

DMP8

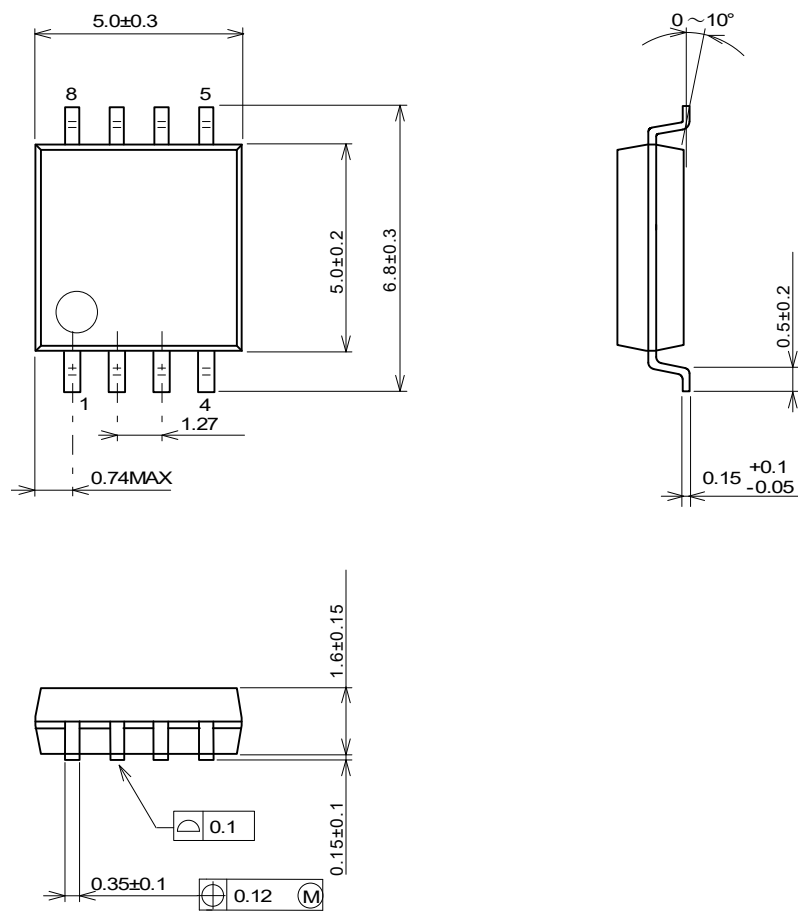

NJM2903C / NJM2903CA

PACKAGE OUTLINE UNIT : mm

MSOP8 (TVSP8)*

*MEET JEDEC MO-187-DA/THIN TYPE

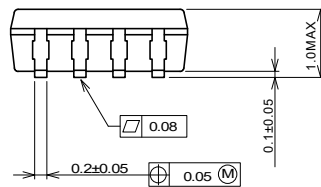
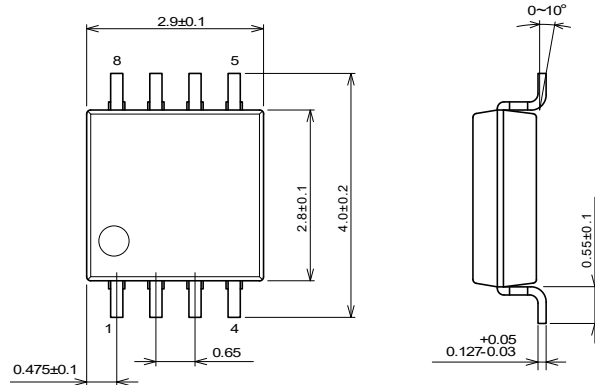

SSOP8

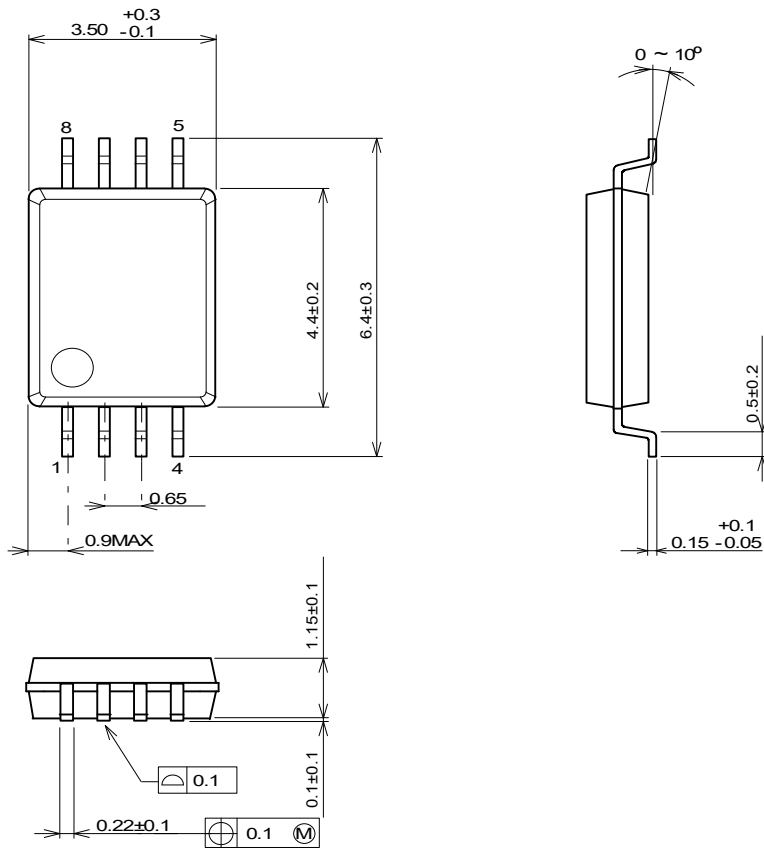

NJM2903C / NJM2903CA

■PACKAGE OUTLINE UNIT : mm
EQFN14-D7

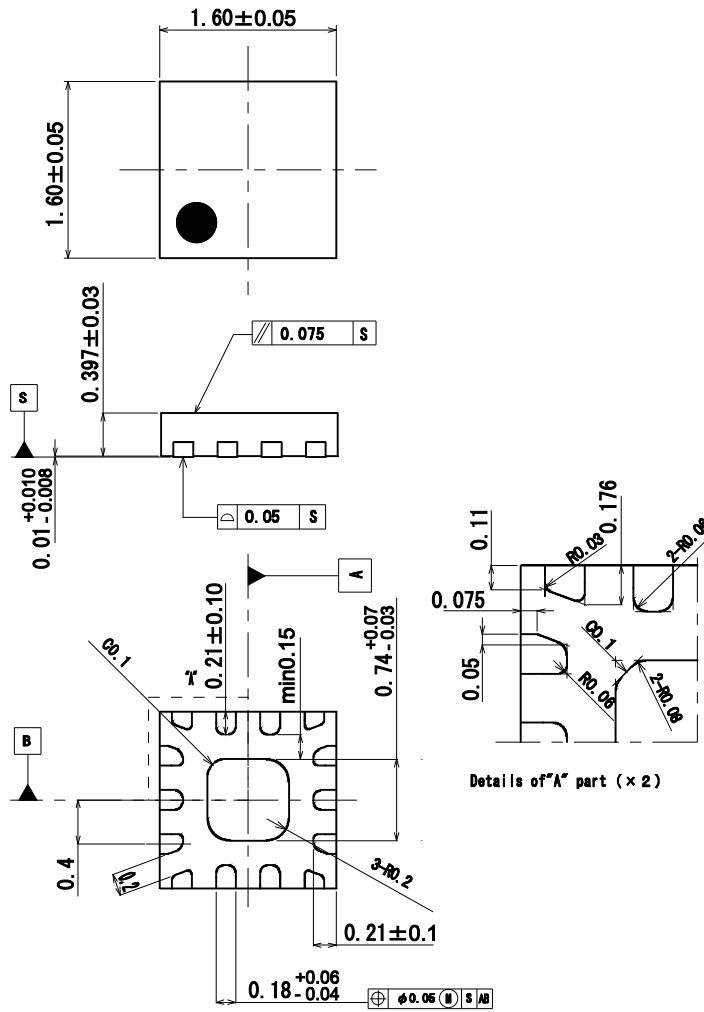

[CAUTION]
The specifications on this databook are only given for information, without any guarantee as regards either mistakes or omissions. The application circuits in this databook are described only to show representative usages of the product and not intended for the guarantee or permission of any right including the industrial rights.