

PLEASE CHECK WWW.MOLEX.COM FOR LATEST PART INFORMATION

Part Number: [84729-0007](#)
Status: **Active**
Overview: Industrial Products
Description: USB Type A Panel Mount Receptacle-to-USB Type A Plug Cord Set, 3.0m Length

Documents:

[Drawing \(PDF\)](#) [RoHS Certificate of Compliance \(PDF\)](#)
[Product Specification PS-84727-002 \(PDF\)](#)

General

Product Family	Cable Assemblies
Series	84729
Comments	Fully shielded for EMI/RFI protection
Connector to Connector	Type A Recept-to-Type A Plug
Overview	Industrial Products
Product Name	Industrial USB
UPC	822348832538

Physical

Cable Length	3.0m
Circuits (Loaded)	4
Color - Resin	Black
Gender	Dual
Lock to Mating Part	None
Material - Resin	Nylon, Polyester
Net Weight	89.720/g
Packaging Type	Bag
Pitch - Mating Interface	2.00mm, 2.50mm
Single Ended	No
Waterproof / Dustproof	Yes
Waterproof / Dustproof Type	IP67, NEMA 6P
Wire Insulation Diameter	3.89mm (.15")
Wire Size AWG	N/A
Wire/Cable Type	USB

Electrical

Current - Maximum per Contact	1A
Impedance	Non-constant
Shield Type	Full Shield
Shielded	Yes
Voltage - Maximum	30V AC (RMS)

Material Info

Reference - Drawing Numbers

Product Specification	PS-84727-002
Sales Drawing	SD-84729-006

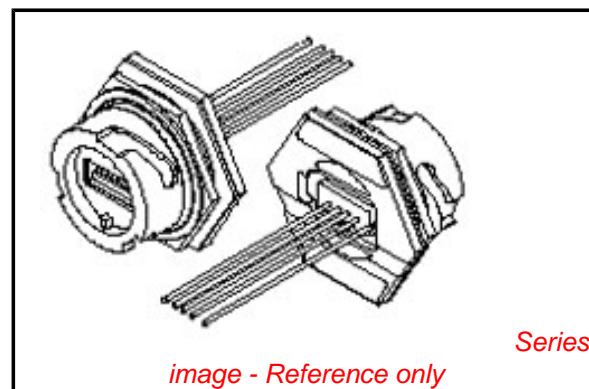

EU RoHS

**ELV and RoHS
Compliant**
REACH SVHC
 Not Reviewed
Low-Halogen Status
 Not Reviewed

China RoHS



**Need more information on product
environmental compliance?**

Email productcompliance@molex.com
 For a multiple part number RoHS Certificate of Compliance, [click here](#)

Please visit the [Contact Us](#) section for any non-product compliance questions.

Search Parts in this Series

[84729Series](#)

Mates With

[84727 USB Type A Plug to Shielded Pigtail Receptacles](#)