

Synchronous DRAM Module

MT9LSDT6472A - 512MB

MT18LSDT12872A - 1GB

For the latest data sheet, refer to Micron's Web site: www.micron.com/products/modules.

Features

- PC100- and PC133-compliant
- 168-pin, dual in-line memory module (DIMM)
- Unbuffered, ECC-optimized pinout
- 512MB (64 Meg x 72) and 1GB (128 Meg x 72)
- Single +3.3V power supply
- Fully synchronous; all signals registered on positive edge of system clock
- Internal pipelined operation; column address can be changed every clock cycle
- Internal SDRAM banks for hiding row access/precharge
- Programmable burst lengths: 1, 2, 4, 8, or full page
- Auto precharge, includes concurrent auto precharge, and auto refresh modes
- Self refresh mode
- 64ms, 8,192-cycle refresh
- LVTTTL-compatible inputs and outputs
- Serial presence-detect (SPD)
- Gold edge contacts

Table 1: Timing Parameters
CL = CAS (READ) latency

Module Marking	Clock Frequency	Access Time		Setup Time	Hold Time
		CL = 2	CL = 3		
-13E	133 MHz	5.4ns	-	1.5	0.8
-133	133 MHz	-	5.4ns	1.5	0.8

Figure 1: 168-Pin DIMM (MO-161)

Standard 1.375in./34.93mm

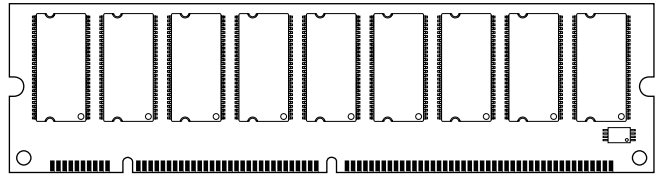

Low Profile 1.125in./28.58mm

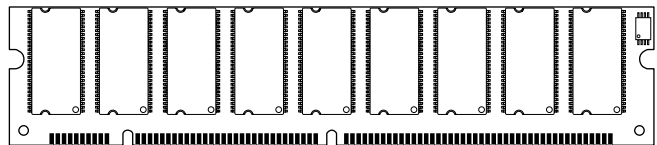

Options

- Package
 - 168-pin DIMM (standard)
 - 168-pin DIMM (lead-free)
- Frequency/CAS latency
 - 7.5ns (133 MHz)/CL = 2
 - 7.5ns (133 MHz)/CL = 3
- PCB
 - Standard (1.375in./34.93mm)
 - Low-Profile (1.125in./28.58mm)

Marking

G
Y¹

-13E
-133

See note 1 on page 2
See note 1 on page 2

Notes: 1. Contact Micron for product availability.

Table 2: Address Table

Parameter	512MB	1GB
Refresh Count	8K	8K
Device Banks	4 (BA0, BA1)	4 (BA0, BA1)
Device Configuration	512Mb (64 Meg x 8)	512Mb (64 Meg x 8)
Row Addressing	8K (A0-A12)	8K (A0-A12)
Column Addressing	2K (A0-A9, A11)	2K (A0-A9, A11)
Module Ranks	1 (S0#, S2#)	2 (S0#, S2#; S1#, S3#)



512MB (SR), 1GB (DR): (x72, ECC) 168-Pin SDRAM UDIMM Features

Table 3: Part Numbers

Part Number ¹	Module Density	Configuration	System Bus Speed
MT9LSDT6472AG-13E_	512MB	64 Meg x 72	133 MHz
MT9LSDT6472AG-13E_	512MB	64 Meg x 72	133 MHz
MT9LSDT6472AG-133_	512MB	64 Meg x 72	133 MHz
MT9LSDT6472AG-133_	512MB	64 Meg x 72	133 MHz
MT18LSDT12872AG-13E_	1GB	128 Meg x 72	133 MHz
MT18LSDT12872AG-13E_	1GB	128 Meg x 72	133 MHz
MT18LSDT12872AG-133_	1GB	128 Meg x 72	133 MHz
MT18LSDT12872AG-133_	1GB	128 Meg x 72	133 MHz

Notes: 1. The designators for component and PCB revision are the last two characters of each part number. Consult factory for current revision codes. Example: MT9LSDT6472AG-133B1.

Pin Assignments and Descriptions

Table 4: Pin Assignment

168-Pin DIMM Front								168-Pin DIMM Back							
Pin	Symbol	Pin	Symbol	Pin	Symbol	Pin	Symbol	Pin	Symbol	Pin	Symbol	Pin	Symbol	Pin	Symbol
1	Vss	22	CB1	43	Vss	64	Vss	85	Vss	106	CB5	127	Vss	148	Vss
2	DQ0	23	Vss	44	NC	65	DQ21	86	DQ32	107	Vss	128	CKE0	149	DQ53
3	DQ1	24	NC	45	S2#	66	DQ22	87	DQ33	108	NC	129	S3#	150	DQ54
4	DQ2	25	NC	46	DQMB2	67	DQ23	88	DQ34	109	NC	130	DQMB6	151	DQ55
5	DQ3	26	VDD	47	DQMB3	68	Vss	89	DQ35	110	VDD	131	DQMB7	152	Vss
6	VDD	27	WE#	48	NC	69	DQ24	90	VDD	111	CAS#	132	NC	153	DQ56
7	DQ4	28	DQMB0	49	VDD	70	DQ25	91	DQ36	112	DQMB4	133	VDD	154	DQ57
8	DQ5	29	DQMB1	50	NC	71	DQ26	92	DQ37	113	DQMB5	134	NC	155	DQ58
9	DQ6	30	S0#	51	NC	72	DQ27	93	DQ38	114	S1#	135	NC	156	DQ59
10	DQ7	31	NC	52	CB2	73	VDD	94	DQ39	115	RAS#	136	CB6	157	VDD
11	DQ8	32	Vss	53	CB3	74	DQ28	95	DQ40	116	Vss	137	CB7	158	DQ60
12	Vss	33	A0	54	Vss	75	DQ29	96	Vss	117	A1	138	Vss	159	DQ61
13	DQ9	34	A2	55	DQ16	76	DQ30	97	DQ41	118	A3	139	DQ48	160	DQ62
14	DQ10	35	A4	56	DQ17	77	DQ31	98	DQ42	119	A5	140	DQ49	161	DQ63
15	DQ11	36	A6	57	DQ18	78	Vss	99	DQ43	120	A7	141	DQ50	162	Vss
16	DQ12	37	A8	58	DQ19	79	CK2	100	DQ44	121	A9	142	DQ51	163	CK3
17	DQ13	38	A10	59	VDD	80	NC	101	DQ45	122	BA0	143	VDD	164	NC
18	VDD	39	BA1	60	DQ20	81	NC	102	VDD	123	A11	144	DQ52	165	SA0
19	DQ14	40	VDD	61	NC	82	SDA	103	DQ46	124	VDD	145	NC	166	SA1
20	DQ15	41	VDD	62	NC	83	SCL	104	DQ47	125	CK1	146	NC	167	SA2
21	CB0	42	CK0	63	CKE1	84	VDD	105	CB4	126	A12	147	NC	168	VDD

Figure 2: 168-Pin DIMM Pin Locations

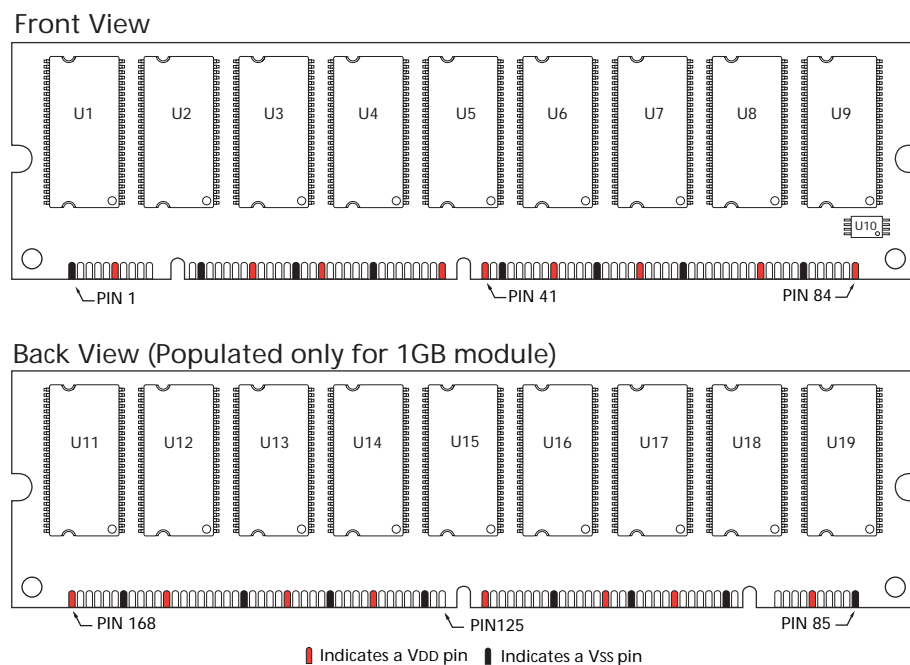



512MB (SR), 1GB (DR): (x72, ECC) 168-Pin SDRAM UDIMM Pin Assignments and Descriptions

Table 5: Pin Descriptions

Pin numbers may not correlate with symbols; refer to the Table 4 on page 3 for pin number and symbol information

Pin Numbers	Symbol	Type	Descriptions
27, 111, 115	RAS#, CAS#, WE#	Input	Command inputs: RAS#, CAS#, and WE# (along with S#) define the command being entered.
42, 79, 125, 163	CK0-CK3	Input	Clock: CK is driven by the system clock. All SDRAM input signals are sampled on the positive edge of CK. CK also increments the internal burst counter and controls the output registers.
63, 128	CKE0, CKE1	Input	Clock enable: CKE activates (HIGH) and deactivates (LOW) the CK signal. Deactivating the clock provides PRECHARGE POWER-DOWN and SELF REFRESH operation (all device banks idle) or CLOCK SUSPEND OPERATION (burst access in progress). CKE is synchronous except after the device enters power-down and self refresh modes, where CKE becomes asynchronous until after exiting the same mode. The input buffers, including CK, are disabled during power-down and self refresh modes, providing low standby power.
30, 45, 114, 129	S0#-S3#	Input	Chip select: S# enables (registered LOW) and disables (registered HIGH) the command decoder. All commands are masked when S# is registered HIGH. S# is considered part of the command code.
28, 29, 46, 47, 112, 113, 130, 131	DQMB0-DQMB7	Input	Input/Output mask: DQMB is an input mask signal for write accesses and an output enable signal for read accesses. Input data is masked when DQMB is sampled HIGH during a WRITE cycle. The output buffers are placed in a High-Z state (two-clock latency) when DQMB is sampled HIGH during a READ cycle.
39, 122	BA0, BA1	Input	Bank address: BA0 and BA1 define to which device bank the ACTIVE, READ, WRITE, or PRECHARGE command is being applied.
33-38, 117-121, 123, 126	A0-A12	Input	Address inputs: Provide the row address for ACTIVE commands, and the column address and auto precharge bit (A10) for READ/WRITE commands, to select one location out of the memory array in the respective device bank. A10 sampled during a PRECHARGE command determines whether the PRECHARGE applies to one device bank (A10 LOW < device bank selected by BA0, BA1) or all device banks (A10 HIGH). The address inputs also provide the op-code during a MODE REGISTER SET command.
83	SCL	Input	Serial clock for presence-detect: SCL is used to synchronize the presence-detect data transfer to and from the module.
165-167	SA0-SA2	Input	Presence-detect address Inputs: These pins are used to configure the presence-detect device.
21, 22, 52, 53, 105, 106, 136, 137	CB0-CB7	Input/Output	Check bits: ECC, 1-bit error detection and correction.
2-5, 7-11, 13-17, 19, 20, 55-58, 60, 65-67, 69-72, 74-77, 86-89, 91-95, 97-101, 103, 104, 139-142, 144, 149-151, 153-156, 158-161	DQ0-DQ63	Input/Output	Data I/O: Data bus.



Table 5: Pin Descriptions (continued)

Pin numbers may not correlate with symbols; refer to the Table 4 on page 3 for pin number and symbol information

Pin Numbers	Symbol	Type	Descriptions
82	SDA	Input/ Output	Serial presence-detect data: SDA is a bidirectional pin used to transfer addresses and data into and out of the presence-detect portion of the module.
6, 18, 26, 40, 41, 49, 59, 73, 84, 90, 102, 110, 124, 133, 143, 157, 168	VDD	Supply	Power Supply: +3.3V ±0.3V.
1, 12, 23, 32, 43, 54, 64, 68, 78, 85, 96, 107, 116, 127, 138, 148, 152, 162	Vss	Supply	Ground.
24, 25, 31, 44, 48, 50, 51, 61, 62, 80, 81, 108, 109, 132, 134, 135, 145, 146, 147	NC	-	Not Connected: These pins are not connected on these modules.

Functional Block Diagrams

All resistor values are 10Ω unless otherwise specified.

Per industry standard, Micron modules use various component speed grades as referenced in the module part numbering guide at www.micron.com/support/numbering.html.

Standard modules use the following SDRAM devices: MT48LC64M8A2TG. Lead-free modules use the following SDRAM devices: MT48LC64M8A2P.

Figure 3: Single Rank

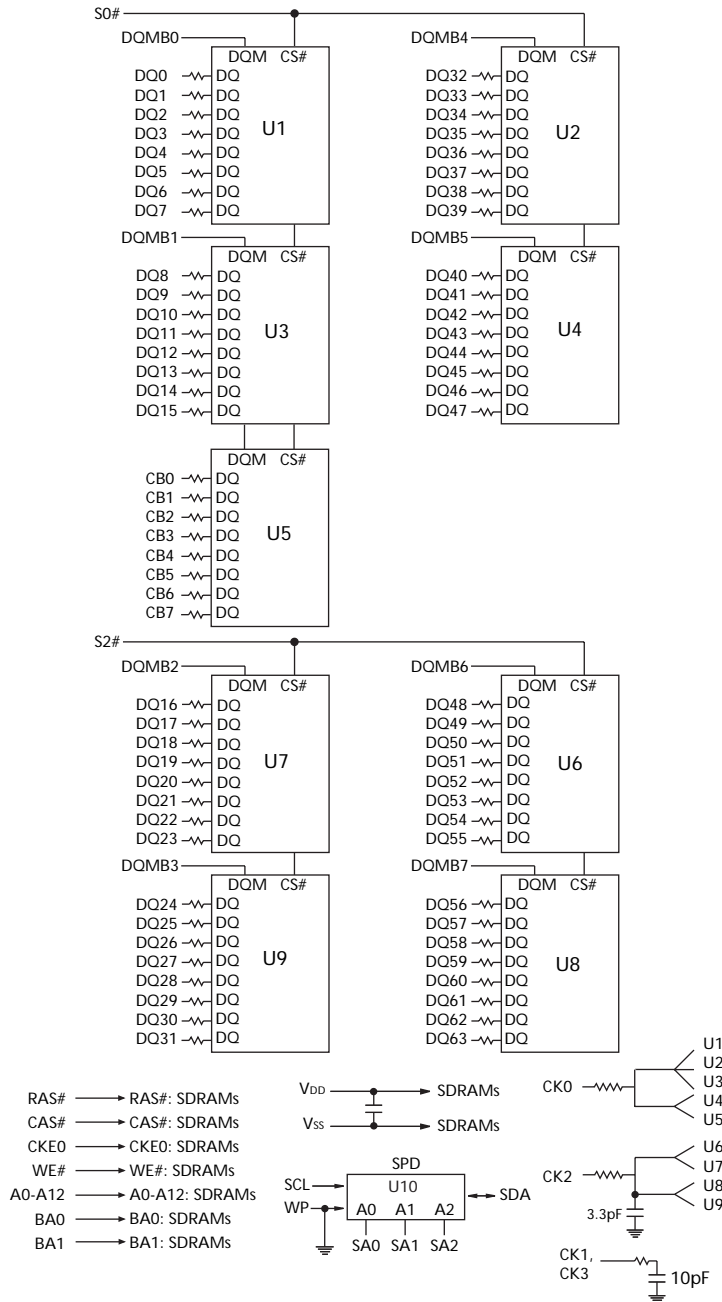
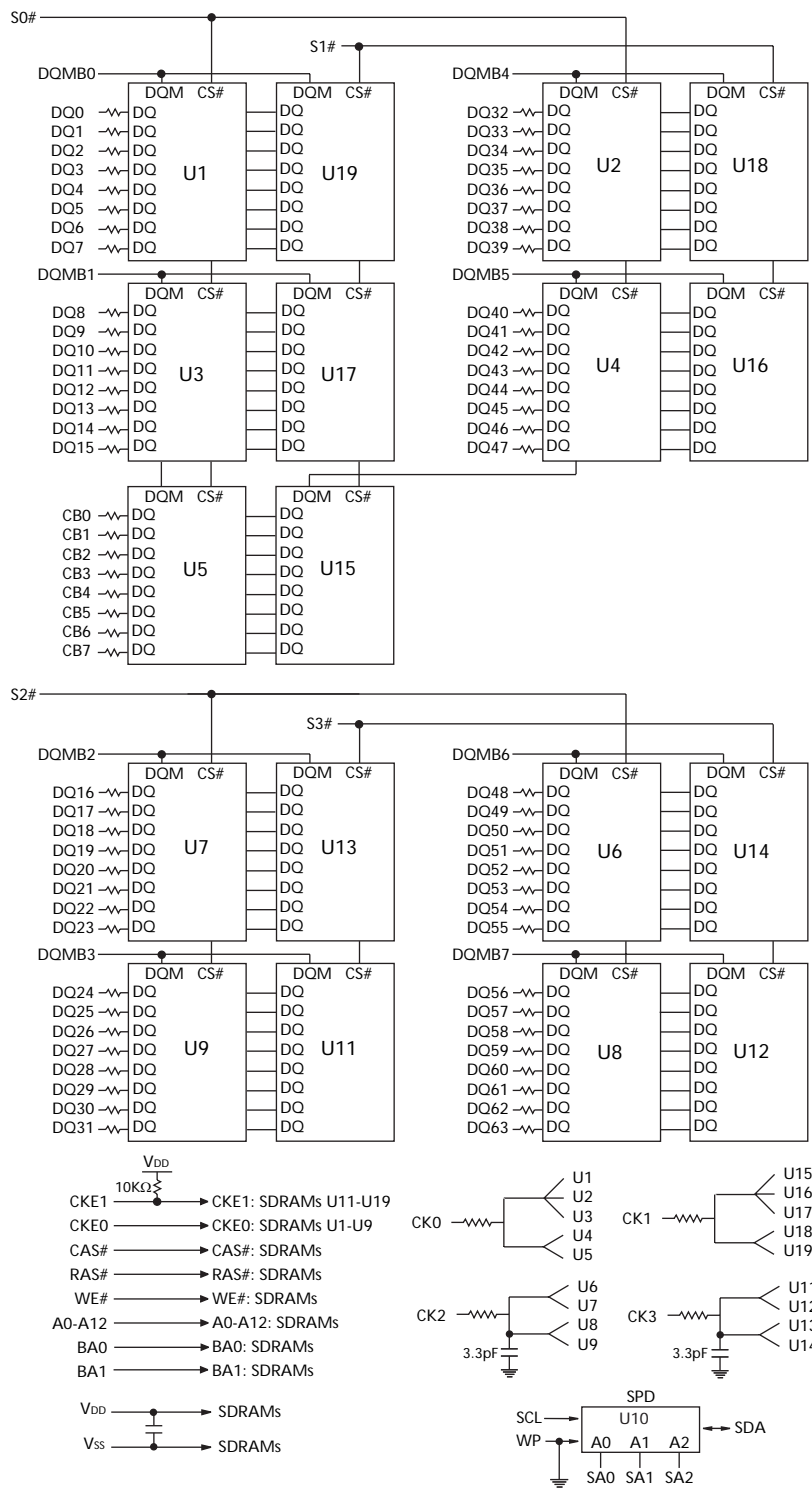

Figure 4: Dual Rank



General Description

The MT9LSDT6472A and MT18LSDT12872A modules are high-speed CMOS, dynamic random-access, 512MB and 1GB DIMMs organized in a x72 configuration. These modules use internally configured quad-bank SDRAMs with a synchronous interface (all signals are registered on the positive edge of the clock signal CK).

Read and write accesses to these SDRAM modules are burst oriented; accesses start at a selected location and continue for a programmed number of locations in a programmed sequence. Accesses begin with the registration of an ACTIVE command, which is then followed by a READ or WRITE command. The address bits registered coincident with the ACTIVE command are used to select the device bank and row to be accessed (BA0, BA1 select the device bank, A0–A12 select the device row). The address bits registered coincident with the READ or WRITE command are used to select the starting column location for the burst access.

These modules provide for programmable READ or WRITE burst lengths of 1, 2, 4, or 8 locations, or the full page, with a burst terminate option. An AUTO PRECHARGE function may be enabled to provide a self-timed row precharge that is initiated at the end of the burst sequence.

These modules use an internal pipelined architecture to achieve high-speed operation. This architecture is compatible with the $2n$ rule of prefetch architectures, but it also allows the column address to be changed on every clock cycle to achieve a high-speed, fully random access. Precharging one device bank while accessing one of the other three device banks will hide the precharge cycles and provide seamless, high-speed, random-access operation.

The modules are designed to operate in 3.3V, low-power memory systems. An auto refresh mode is provided, along with a power-saving, power-down mode. All inputs and outputs are LVTTTL-compatible.

SDRAM modules offer substantial advances in DRAM operating performance, including the ability to synchronously burst data at a high data rate with automatic column-address generation, the ability to interleave between internal device banks in order to hide precharge time and the capability to randomly change column addresses on each clock cycle during a burst access. For more information regarding SDRAM operation, refer to the 512Mb SDRAM component data sheet.

Serial Presence-Detect Operation

These modules incorporate serial presence-detect (SPD). The SPD function is implemented using a 2,048-bit EEPROM. This nonvolatile storage device contains 256 bytes. The first 128 bytes can be programmed by Micron to identify the module type and various SDRAM organizations and timing parameters. The remaining 128 bytes of storage are available for use by the customer. System READ/WRITE operations between the master (system logic) and the slave EEPROM device (DIMM) occur via a standard I²C bus using the DIMM's SCL (clock) and SDA (data) signals, together with SA (2:0), which provide 8 unique DIMM/EEPROM addresses.

Initialization

SDRAMs must be powered up and initialized in a predefined manner. Operational procedures other than those specified may result in undefined operation. Once power is applied to VDD and VDDQ (simultaneously) and the clock is stable (stable clock is defined as a signal cycling within timing constraints specified for the clock pin), the SDRAM requires a 100µs delay prior to issuing any command other than a COMMAND

INHIBIT or NOP. Starting at some point during this 100 μ s period and continuing at least through the end of this period, COMMAND INHIBIT or NOP commands should be applied.

Once the 100 μ s delay has been satisfied with at least one COMMAND INHIBIT or NOP command having been applied, a PRECHARGE command should be applied. All device banks must then be precharged, thereby placing the device in the all banks idle state.

Once in the idle state, two AUTO REFRESH cycles must be performed. After the AUTO REFRESH cycles are complete, the SDRAM is ready for mode register programming. Because the mode register will power up in an unknown state, it should be loaded prior to applying any operational command.

Mode Register Definition

The mode register is used to define the specific mode of operation of the SDRAM. This definition includes the selection of a burst length, a burst type, a CAS latency, an operating mode and a write burst mode, as shown in Figure 5 on page 10. The mode register is programmed via the LOAD MODE REGISTER command and will retain the stored information until it is programmed again or the device loses power.

Mode register bits M0–M2 specify the burst length, M3 specifies the type of burst (sequential or interleaved), M4–M6 specify the CAS latency, M7 and M8 specify the operating mode, M9 specifies the write burst mode, and M10 and M11 are reserved for future use. Address A12 (M12) is undefined but should be driven LOW during loading of the mode register.

The mode register must be loaded when all device banks are idle, and the controller must wait the specified time before initiating the subsequent operation. Violating either of these requirements will result in unspecified operation.

Burst Length

Read and write accesses to the SDRAM are burst oriented, with the burst length being programmable, as shown in Figure 5 on page 10. The burst length determines the maximum number of column locations that can be accessed for a given READ or WRITE command. Burst lengths of 1, 2, 4, or 8 locations are available for both the sequential and the interleaved burst types, and a full-page burst is available for the sequential type. The full-page burst is used in conjunction with the BURST TERMINATE command to generate arbitrary burst lengths.

Reserved states should not be used, as unknown operation or incompatibility with future versions may result.

When a READ or WRITE command is issued, a block of columns equal to the burst length is effectively selected. All accesses for that burst take place within this block, meaning that the burst will wrap within the block if a boundary is reached, as shown in the Table 6 on page 11. The block is uniquely selected by A1–A9, A11 when BL = 2; A2–A9, A11 when BL = 4; and by A3–A9, A11 when BL = 8. The remaining (least significant) address bit(s) is (are) used to select the starting location within the block.

Full-page bursts wrap within the page if the boundary is reached, as shown in Table 6 on page 11.

Burst Type

Accesses within a given burst may be programmed to be either sequential or interleaved; this is referred to as the burst type and is selected via bit M3.

The ordering of accesses within a burst is determined by the burst length, the burst type, and the starting column address, as shown in Table 6 on page 11.

Figure 5: Mode Register Definition Diagram

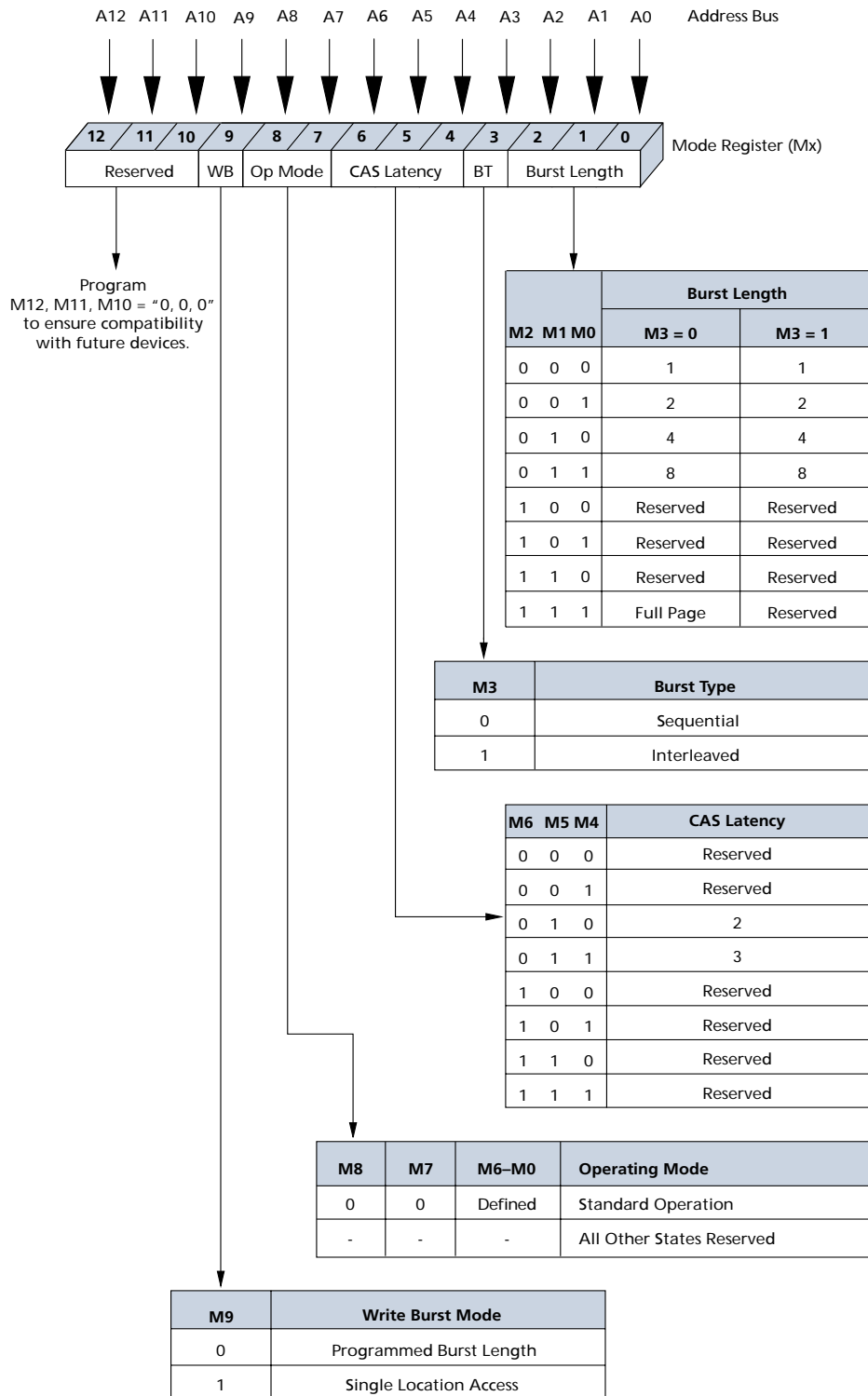
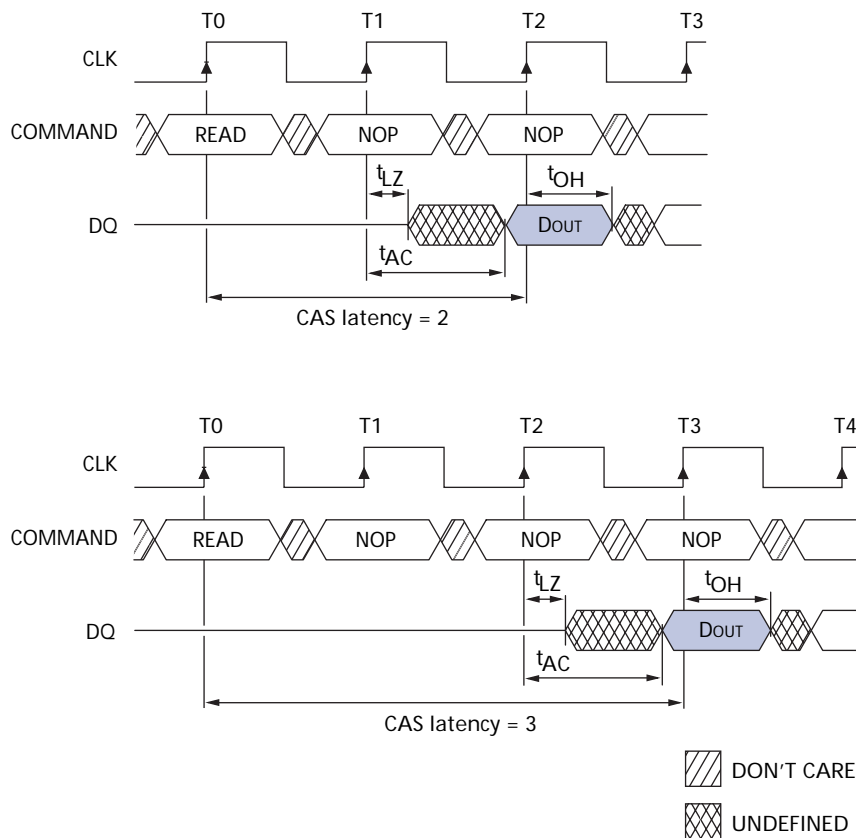

Table 6: Burst Definition Table

Burst Length	Starting Column Address			Order of Accesses Within a Burst	
				Type = Sequential	Type = Interleaved
2	A0				
	0			0-1	0-1
	1			1-0	1-0
4	A1		A0		
	0		0	0-1-2-3	0-1-2-3
	0		1	1-2-3-0	1-0-3-2
	1		0	2-3-0-1	2-3-0-1
	1		1	3-0-1-2	3-2-1-0
8	A2	A1	A0		
	0	0	0	0-1-2-3-4-5-6-7	0-1-2-3-4-5-6-7
	0	0	1	1-2-3-4-5-6-7-0	1-0-3-2-5-4-7-6
	0	1	0	2-3-4-5-6-7-0-1	2-3-0-1-6-7-4-5
	0	1	1	3-4-5-6-7-0-1-2	3-2-1-0-7-6-5-4
	1	0	0	4-5-6-7-0-1-2-3	4-5-6-7-0-1-2-3
	1	0	1	5-6-7-0-1-2-3-4	5-4-7-6-1-0-3-2
	1	1	0	6-7-0-1-2-3-4-5	6-7-4-5-2-3-0-1
1	1	1	7-0-1-2-3-4-5-6	7-6-5-4-3-2-1-0	
Full Page (y)	n = A0–A9, A11 (location 0-y)			Cn, Cn+1, Cn+2 Cn+3, Cn+4... ...Cn-1, Cn...	Not Supported

- Notes:
1. For full-page accesses: $y = 2,048$.
 2. For BL = 2, A1–A9, A11 select the block of two burst; A0 selects the starting column within the block.
 3. For BL = 4, A2–A9, A11 select the block of four burst; A0–A1 select the starting column within the block.
 4. For BL = 8, A3–A9, A11 select the block of eight burst; A0–A2 select the starting column within the block.
 5. For a full-page burst, the full row is selected and A0–A9, A11 select the starting column.
 6. Whenever a boundary of the block is reached within a given sequence above, the following access wraps within the block.
 7. For BL = 1, A0–A9, A11 select the unique column to be accessed, and mode register bit M3 is ignored.

Figure 6: CAS Latency Diagram



CAS Latency

The CAS latency is the delay, in clock cycles, between the registration of a READ command and the availability of the first piece of output data. The latency can be set to two or three clocks.

If a READ command is registered at clock edge n , and the latency is m clocks, the data will be available by clock edge $n + m$. The DQs will start driving as a result of the clock edge one cycle earlier ($n + m - 1$), and provided that the relevant access times are met, the data will be valid by clock edge $n + m$. For example, assuming that the clock cycle time is such that all relevant access times are met, if a READ command is registered at T0 and the latency is programmed to two clocks, the DQs will start driving after T1 and the data will be valid by T2, as shown in Figure 6. Table 7 on page 13, indicates the operating frequencies at which each CAS latency setting can be used.

Reserved states should not be used as unknown operation or incompatibility with future versions may result.

Operating Mode

The normal operating mode is selected by setting M7 and M8 to zero; the other combinations of values for M7 and M8 are reserved for future use and/or test modes. The programmed burst length applies to both READ and WRITE bursts.

Test modes and reserved states should not be used because unknown operation or incompatibility with future versions may result.

Write Burst Mode

When M9 = 0, the burst length programmed via M0–M 2 applies to both READ and WRITE bursts; when M9 = 1, the programmed burst length applies to READ bursts, but write accesses are single-location (non burst) accesses.

Table 7: CAS Latency Table

Speed	Allowable Operating Clock Frequency (MHz)	
	CAS Latency = 2	CAS Latency = 3
-13E	≤ 133	≤ 143
-133	≤ 100	≤ 133

Commands

Table 8 provides a quick reference of available commands. This is followed by a written description of each command. For a more detailed description of commands and operations, refer to the 512Mb SDRAM component data sheet.

Table 8: Truth Table – SDRAM Commands and DQMB Operation

CKE is HIGH for all commands shown except SELF REFRESH; notes appear following the Truth Table

Name (Function)	CS#	RAS#	CAS#	WE#	DQMB	ADDR	DQ	Notes
COMMAND INHIBIT (NOP)	H	X	X	X	X	X	X	
NO OPERATION (NOP)	L	H	H	H	X	X	X	
ACTIVE (Select bank and activate row)	L	L	H	H	X	Bank/Row	X	1
READ (Select bank and column, and start READ burst)	L	H	L	H	L/H	Bank/Col	X	2
WRITE (Select bank and column, and start WRITE burst)	L	H	L	L	L/H	Bank/Col	Valid	2
BURST TERMINATE	L	H	H	L	X	X	Active	
PRECHARGE (Deactivate row in bank or banks)	L	L	H	L	X	Code	X	3
AUTO REFRESH or SELF REFRESH (Enter self refresh mode)	L	L	L	H	X	X	X	4, 5
LOAD MODE REGISTER	L	L	L	L	X	Op-code	X	6
Write Enable/Output Enable	-	-	-	-	L	-	Active	7
Write Inhibit/Output High-Z	-	-	-	-	H	-	High-Z	7

- Notes:
1. A0–A12 provide row address; BA0–BA1 determine which device bank is made active.
 2. A0–A9, A11 provide column address; A10 HIGH enables the auto-precharge feature (non-persistent), while A10 LOW disables the auto-precharge feature; BA0–BA1 determine which device bank is being read from or written to.
 3. A10 LOW: BA0–BA1 determine which device bank is being precharged. A10 HIGH: all device banks are precharged and BA0, BA1 are “Don’t Care.”
 4. This command is AUTO REFRESH if CKE is HIGH, SELF REFRESH if CKE is LOW.
 5. Internal refresh counter controls row addressing; all inputs and I/Os are “Don’t Care” except for CKE.
 6. A0–A11 define the op-code written to the mode register and A12 should be driven LOW.
 7. Activates or deactivates the DQs during WRITES (zero-clock delay) and READS (two-clock delay).



Absolute Maximum Ratings

Stresses greater than those listed may cause permanent damage to the device. This is a stress rating only, and functional operation of the device at these or any other conditions above those indicated in the operational sections of this specification is not implied. Exposure to absolute maximum rating conditions for extended periods may affect reliability.

Table 9: Absolute Maximum DC Ratings

Parameter	Min	Max	Units
Voltage on VDD, VDDQ supply relative to Vss	-1	+4.6	V
Voltage on inputs NC or I/O pins relative to Vss	-1	+4.6	V
Operating temperature T _{OPR} (commercial - ambient)	0	+65	°C
Storage temperature (plastic)	-55	+150	°C

DC Operating Specifications

Table 10: DC Electrical Characteristics and Operating Conditions – 512MB

Notes: 1, 5, 6; notes appear on page 19; VDD = VDDQ = +3.3V ±0.3V

Parameter/Condition	Symbol	Min	Max	Units	Notes	
Supply voltage	VDD, VDDQ	3	3.6	V		
Input high voltage: Logic 1; All inputs	V _{IH}	2	VDD + 0.3	V	22	
Input low voltage: Logic 0; All inputs	V _{IL}	-0.3	0.8	V	22	
Input leakage current: Any input 0V ≤ V _{IN} ≤ VDD (All other pins not under test = 0V)	Command and address inputs, CKE	-45	45	μA	33	
	CK0, S0#	-25	25	μA		
	CK2, S2#	-20	20	μA		
	DQMB	-5	5	μA		
Output leakage current: DQ pins are disabled; 0V ≤ V _{OUT} ≤ VDDQ	DQ	I _{OZ}	-5	5	μA	33
Output levels: Output high voltage (I _{OUT} = -4mA) Output low voltage (I _{OUT} = 4mA)	V _{OH}	2.4	-	V		
	V _{OL}	-	0.4	V		

Table 11: DC Electrical Characteristics and Operating Conditions – 1GB

Notes: 1, 5, 6; notes appear on page 19; VDD = VDDQ = +3.3V ±0.3V

Parameter/Condition	Symbol	Min	Max	Units	Notes
Supply Voltage	VDD, VDDQ	3	3.6	V	
Input high voltage: Logic 1; All inputs	V _{IH}	2	VDD + 0.3	V	22
Input low voltage: Logic 0; All inputs	V _{IL}	-0.3	0.8	V	22
Input leakage current: Any input 0V ≤ V _{IN} ≤ VDD (All other pins not under test = 0V)	Command and address inputs	-90	90	μA	33
	CKE	-45	45	μA	
	CK0, CK1, S0#, S1#	-25	25	μA	
	CK2, CK3, S2#, S3#	-20	20	μA	
	DQMB	-10	10	μA	



Table 11: DC Electrical Characteristics and Operating Conditions – 1GB (continued)

Notes: 1, 5, 6; notes appear on page 19; VDD = VDDQ = +3.3V ±0.3V

Parameter/Condition	Symbol	Min	Max	Units	Notes
Output leakage current: DQ pins are disabled; $0V \leq V_{OUT} \leq V_{DDQ}$	IOZ	-10	10	μA	33
Output levels:	VOH	2.4	-	V	
Output High Voltage (I _{OUT} = -4mA)	VOL	-	0.4	V	
Output Low Voltage (I _{OUT} = 4mA)					

IDD Specifications and Conditions

Table 12: IDD Specifications and Conditions – 512MB

Notes: 1, 5, 6, 11, 13; notes appear on page 19; VDD = VDDQ = +3.3V ±0.3V; SDRAM component values only

Parameter/Condition	Symbol	Max		Units	Notes	
		-13E	-133			
Operating current: active mode; Burst = 2; READ or WRITE; $t_{RC} = t_{RC}$ (MIN)	IDD1	1,080	990	mA	3, 18, 19, 30	
Standby current: Power-Down mode; All device banks idle; CKE = LOW	IDD2	32	32	mA	30	
STANDBY CURRENT: Active Mode; CKE = HIGH; CS# = HIGH; All device banks active after t_{RCD} met; No accesses in progress	IDD3	405	405	mA	3, 18, 19, 30	
Operating current: Burst Mode; Continuous burst; READ or WRITE; All device banks active	IDD4	1,125	1,125	mA	3, 18, 19, 30	
Auto refresh current: CKE = HIGH; CS# = HIGH	$t_{RFC} = t_{RFC}$ (MIN)	IDD5	2,205	2,205	mA	3, 12
	$t_{RFC} = 7.8125\mu s$	IDD6	54	54	mA	18, 19, 30, 31
Self refresh current: CKE ≤ 0.2V	IDD7	54	54	mA	4	

Table 13: IDD Specifications and Conditions – 1GB

Notes: 1, 5, 6, 11, 13; notes appear on page 19; VDD, VDDQ = +3.3V ±0.3V; SDRAM component values only

Parameter/Condition	Symbol	Max		Units	Notes	
		-13E	-133			
Operating current: Active Mode; Burst = 2; READ or WRITE; $t_{RC} = t_{RC}$ (MIN)	IDD1 ^a	1,112	1,008	mA	3, 18, 19, 30	
Standby current: Power-Down mode; All device banks idle; CKE = LOW	IDD2 ^b	63	63	mA	30	
Standby current: Active mode; CKE = HIGH; CS# = HIGH; All device banks active after t_{RCD} met; No accesses in progress	IDD3 ^a	437	437	mA	3, 18, 19, 30	
Operating current: Burst mode; Continuous burst; READ or WRITE; All device banks active	IDD4 ^a	1,157	1,157	mA	3, 18, 19, 30	
Auto refresh current: CKE = HIGH; CS# = HIGH	$t_{RFC} = t_{RFC}$ (MIN)	IDD5 ^b	7,200	7,200	mA	3, 12
	$t_{RFC} = 7.8125\mu s$	IDD6 ^b	180	180	mA	18, 19, 30, 31
Self refresh current: CKE ≤ 0.2V	IDD7 ^b	108	108	mA	4	

Note: a - Value calculated as one module rank in this condition, and all other module ranks in power-down mode (IDD2).

b - Value calculated reflects all module ranks in this condition.

Capacitance

Table 14: Capacitance – 128MB

Note 2; notes appear on page 19

Parameter	Symbol	Min	Max	Units
Input capacitance: Address and command	CI1	22.5	34.2	pF
Input capacitance: CK0	CI2	12.5	17.5	pF
Input capacitance: CK2	CI2	13.3	17.3	pF
Input capacitance: S0#	CI3	12.5	19	pF
Input capacitance: S2#	CI3	10	15.2	pF
Input capacitance: CKE	CI4	22.5	34.2	pF
Input capacitance: DQMB0, 2–4, 6, 7	CI5	2.5	3.8	pF
Input capacitance: DQMB1	CI6	5	7.6	pF
Input/Output capacitance: DQ, CB	CI0	4	6	pF

Table 15: Capacitance – 256MB

Note 2; notes appear on page 19

Parameter	Symbol	Min	Max	Units
Input capacitance: Address and command	CI1	45	68.4	pF
Input capacitance: CK0	CI2	12.5	17.5	pF
Input capacitance: CK2	CI2	13.3	17.3	pF
Input capacitance: S0#	CI3	12.5	19	pF
Input capacitance: S2#	CI3	10	15.2	pF
Input capacitance: CKE	CI4	22.5	34.2	pF
Input capacitance: DQMB0, 2–4, 6, 7	CI5	5	7.6	pF
Input capacitance: DQMB1	CI6	7.5	11.4	pF
Input/Output capacitance: DQ, CB	CI0	8	12	pF



AC Operating Specifications

Table 16: Electrical Characteristics and Recommended AC Operating Conditions

Notes: 5, 6, 8, 9, 11, 31; notes appear on page 19

Module AC timing parameters comply with PC100 and PC133 design specifications, based on component parameters

AC Characteristics		Symbol	-13E		-133		Units	Notes
Parameter			Min	Max	Min	Max		
Access time from CLK (positive edge)	CL = 3	$t_{AC(3)}$		5.4		5.4	ns	27
	CL = 2	$t_{AC(2)}$		5.4		6	ns	
Address hold time		t_{AH}	0.8		0.8		ns	
Address setup time		t_{AS}	1.5		1.5		ns	
CLK high-level width		t_{CH}	2.5		2.5		ns	
CLK low-level width		t_{CL}	2.5		2.5		ns	
Clock cycle time	CL = 3	$t_{CK(3)}$	7		7.5		ns	23
	CL = 2	$t_{CK(2)}$	7.5		10		ns	23
CKE hold time		t_{CKH}	0.8		0.8		ns	
CKE setup time		t_{CKS}	1.5		1.5		ns	
CS#, RAS#, CAS#, WE#, DQM hold time		t_{CMH}	0.8		0.8		ns	
CS#, RAS#, CAS#, WE#, DQM setup time		t_{CMS}	1.5		1.5		ns	
Data-in hold time		t_{DH}	0.8		0.8		ns	
Data-in setup time		t_{DS}	1.5		1.5		ns	
Data-out High-Z time	CL = 3	$t_{HZ(3)}$		5.4		5.4	ns	10
	CL = 2	$t_{HZ(2)}$		5.4		6	ns	10
Data-out Low-Z time		t_{LZ}	1		1		ns	
Data-out hold time (load)		t_{OH}	3		3		ns	
Data-out hold time (no load)		t_{OH_N}	1.8		1.8		ns	28
ACTIVE-to-PRECHARGE command		t_{RAS}	37	120,000	44	120,000	ns	32
ACTIVE-to-ACTIVE command period		t_{RC}	60		66		ns	
ACTIVE-to-READ or WRITE delay		t_{RCD}	15		20		ns	
Refresh period (8,192rows)		t_{REF}		64		64	ms	
AUTO REFRESH period		t_{RFC}	66		66		ns	
PRECHARGE command period		t_{RP}	15		20		ns	
ACTIVE bank <i>a</i> to ACTIVE bank <i>b</i> command		t_{RRD}	14		15		ns	
Transition time		t_T	0.3	1.2	0.3	1.2	ns	7
WRITE recovery time		t_{WR}	1 CLK + 7ns		1 CLK + 7.5ns		ns	24
			14		15		ns	25
Exit SELF REFRESH-to-ACTIVE command		t_{XSR}	67		75		ns	20



Table 17: AC Functional Characteristics

Notes: 5, 6, 7, 8, 9, 11, 31; notes appear on page 19

Parameter	Symbol	-13E	-133	Units	Notes	
READ/WRITE command to READ/WRITE command	t_{CCD}	1	1	t_{CK}	17	
CKE to clock disable or power-down entry mode	t_{CKED}	1	1	t_{CK}	14	
CKE to clock enable or power-down exit setup mode	t_{PED}	1	1	t_{CK}	14	
DQM to input data delay	t_{DQD}	0	0	t_{CK}	17	
DQM to data mask during WRITES	t_{DQM}	0	0	t_{CK}	17	
DQM to data High-Z during READs	t_{DQZ}	2	2	t_{CK}	17	
WRITE command to input data delay	t_{DWD}	0	0	t_{CK}	17	
Data-in to ACTIVE command	t_{DAL}	4	5	t_{CK}	15, 21	
Data-in to PRECHARGE command	t_{DPL}	2	2	t_{CK}	16, 21	
Last data-in to burst STOP command	t_{BDL}	1	1	t_{CK}	17	
Last data-in to new READ/WRITE command	t_{CDL}	1	1	t_{CK}	17	
Last data-in to PRECHARGE command	t_{RDL}	2	2	t_{CK}	16, 21	
LOAD MODE REGISTER command to ACTIVE or REFRESH command	t_{MRD}	2	2	t_{CK}	26	
Data-out to High-Z from PRECHARGE command	CL = 3	$t_{ROH(3)}$	3	3	t_{CK}	17
	CL = 2	$t_{ROH(2)}$	2	2	t_{CK}	17

Notes

1. All voltages referenced to VSS.
2. This parameter is sampled. VDD, VDDQ = +3.3V; T_A = 25°C; pin under test biased at 1.4V; f = 1 MHz.
3. IDD is dependent on output loading and cycle rates. Specified values are obtained with minimum cycle time and the outputs open.
4. Enables on-chip refresh and address counters.
5. The minimum specifications are used only to indicate cycle time at which proper operation over the full temperature range is ensured.
6. An initial pause of 100μs is required after power-up, followed by two AUTO REFRESH commands, before proper device operation is ensured. (VDD and VDDQ must be powered up simultaneously. VSS and VSSQ must be at same potential.) The two AUTO REFRESH command wake-ups should be repeated any time the t^{REF} refresh requirement is exceeded.
7. AC characteristics assume t^T = 1ns.
8. In addition to meeting the transition rate specification, the clock and CKE must transit between V_{IH} and V_{IL} (or between V_{IL} and V_{IH}) in a monotonic manner.
9. Outputs measured at 1.5V with equivalent load:

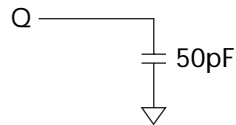

10. t^{HZ} defines the time at which the output achieves the open circuit condition; it is not a reference to V_{OH} or V_{OL}. The last valid data element will meet t^{OH} before going High-Z.
11. AC timing and IDD tests have V_{IL} = 0V and V_{IH} = 3.0V, with timing referenced to 1.5V crossover point. If the input transition time is longer than 1ns, then the timing is referenced at V_{IL} (MAX) and V_{IH} (MIN) and no longer at the ISV crossover point.
12. Other input signals are allowed to transition no more than once every two clocks and are otherwise at valid V_{IH} or V_{IL} levels.
13. IDD specifications are tested after the device is properly initialized.
14. Timing actually specified by t^{CKS}; clock(s) specified as a reference only at minimum cycle rate.
15. Timing actually specified by t^{WR} plus t^{RP}; clock(s) specified as a reference only at minimum cycle rate.
16. Timing actually specified by t^{WR}.
17. Required clocks are specified by JEDEC functionality and are not dependent on any timing parameter.
18. The IDD current will increase or decrease proportionally according to the amount of frequency alteration for the test condition.
19. Address transitions average one transition every two clocks.
20. CLK must be toggled a minimum of two times during this period.
21. Based on t^{CK} = 7.5ns for -133 and -13E.
22. V_{IH} overshoot: V_{IH} (MAX) = VDDQ + 2V for a pulse width ≤ 3ns, and the pulse width cannot be greater than one third of the cycle rate. V_{IL} undershoot: V_{IL} (MIN) = -2V for a pulse width ≤ 3ns for all inputs except A12. V_{IH} overshoot for pin A12 is limited to VDDQ + 1V for a pulse width ≤ 3ns, and the pulse width cannot be greater than one third of the cycle rate.

23. The clock frequency must remain constant (stable clock is defined as a signal cycling within timing constraints specified for the clock pin) during access or precharge states (READ, WRITE, including t^{WR} , and PRECHARGE commands). CKE may be used to reduce the data rate.
24. Auto precharge mode only. The precharge timing budget (t^{RP}) begins at 7ns for -13E; and 7.5ns for -133, after the first clock delay, after the last WRITE is executed. May not exceed limit set for precharge mode.
25. Precharge mode only.
26. JEDEC and PC100 specify three clocks.
27. t^{AC} for -133/-13E at CL = 3 with no load is 4.6ns and is guaranteed by design.
28. Parameter guaranteed by design.
29. For -13E, CL = 2 and $t^{CK} = 7.5ns$; for -133, CL = 3 and $t^{CK} = 7.5ns$.
30. CKE is HIGH during refresh command period t^{RFC} (MIN) else CKE is LOW. The I_{DD6} limit is actually a nominal value and does not result in a fail value.
31. Refer to device data sheet for timing waveforms.
32. The value of t^{RAS} used in -13E speed grade modules is calculated from $t^{RC} - t^{RP}$.
33. Leakage number reflects the worst-case leakage possible through the module pin, not what each memory device contributes.

Serial Presence Detect

SPD Clock and Data Conventions

Data states on the SDA line can change only during SCL LOW. SDA state changes during SCL HIGH are reserved for indicating start and stop conditions (as shown in Figure 7, and Figure 8 on page 22).

SPD Start Condition

All commands are preceded by the start condition, which is a HIGH-to-LOW transition of SDA when SCL is HIGH. The SPD device continuously monitors the SDA and SCL lines for the start condition and will not respond to any command until this condition has been met.

SPD Stop Condition

All communications are terminated by a stop condition, which is a LOW-to-HIGH transition of SDA when SCL is HIGH. The stop condition is also used to place the SPD device into standby power mode.

SPD Acknowledge

Acknowledge is a software convention used to indicate successful data transfers. The transmitting device, either master or slave, will release the bus after transmitting 8 bits. During the ninth clock cycle, the receiver will pull the SDA line LOW to acknowledge that it received the 8 bits of data (as shown in Figure 9 on page 22).

The SPD device will always respond with an acknowledge after recognition of a start condition and its slave address. If both the device and a WRITE operation have been selected, the SPD device will respond with an acknowledge after the receipt of each subsequent 8-bit word. In the read mode, the SPD device will transmit 8 bits of data, release the SDA line, and monitor the line for an acknowledge. If an acknowledge is detected and no stop condition is generated by the master, the slave will continue to transmit data. If an acknowledge is not detected, the slave will terminate further data transmissions and await the stop condition to return to standby power mode.

Figure 7: Data Validity

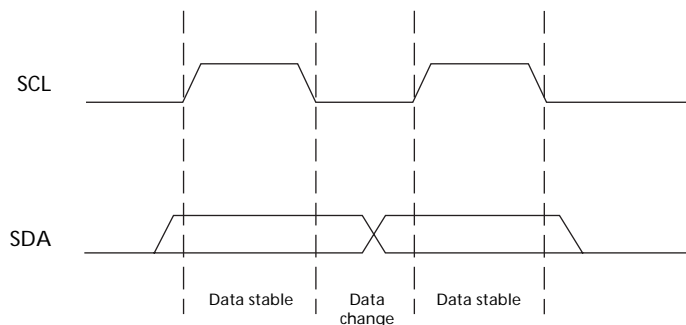

Figure 8: Definition of Start and Stop

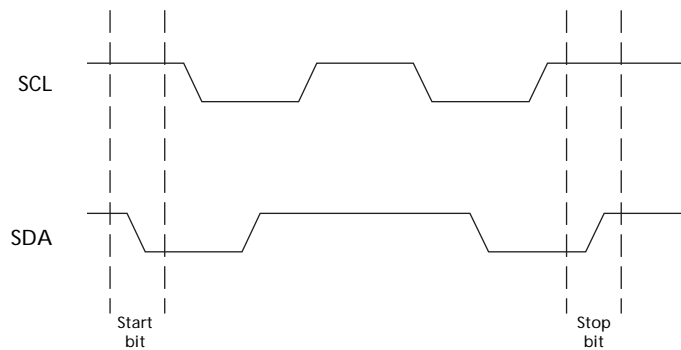

Figure 9: Acknowledge Response From Receiver

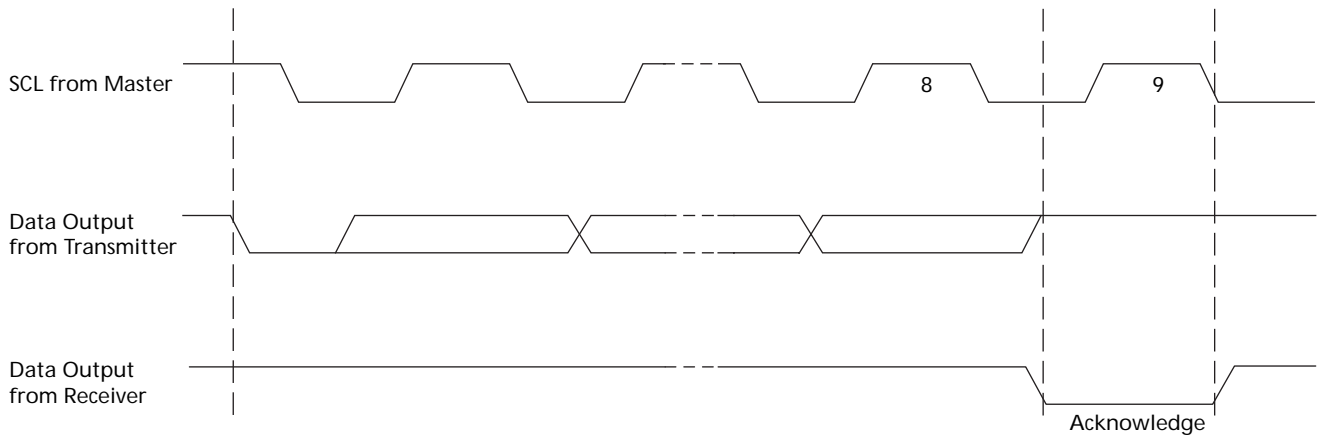

Table 18: EEPROM Device Select Code
The most significant bit (b7) is sent first

	Device Type Identifier				Chip Enable			R \bar{W}
	b7	b6	b5	b4	b3	b2	b1	b0
Memory area select code (two arrays)	1	0	1	0	SA2	SA1	SA0	R \bar{W}
Protection register select code	0	1	1	0	SA2	SA1	SA0	R \bar{W}

Table 19: EEPROM Operating Modes

Mode	R \bar{W} Bit	$\bar{W}C$	Bytes	Initial Sequence
Current address read	1	V _{IH} or V _{IL}	1	Start, device select, R \bar{W} = 1
Random address read	0	V _{IH} or V _{IL}	1	Start, device select, R \bar{W} = 0, Address
	1	V _{IH} or V _{IL}		Restart, device select, R \bar{W} = 1
Sequential read	1	V _{IH} or V _{IL}	≥ 1	Similar to current or random address read
Byte write	0	V _{IL}	1	Start, device select, R \bar{W} = 0
Page write	0	V _{IL}	≤ 16	Start, device select, R \bar{W} = 0

Figure 10: SPD EEPROM Timing Diagram

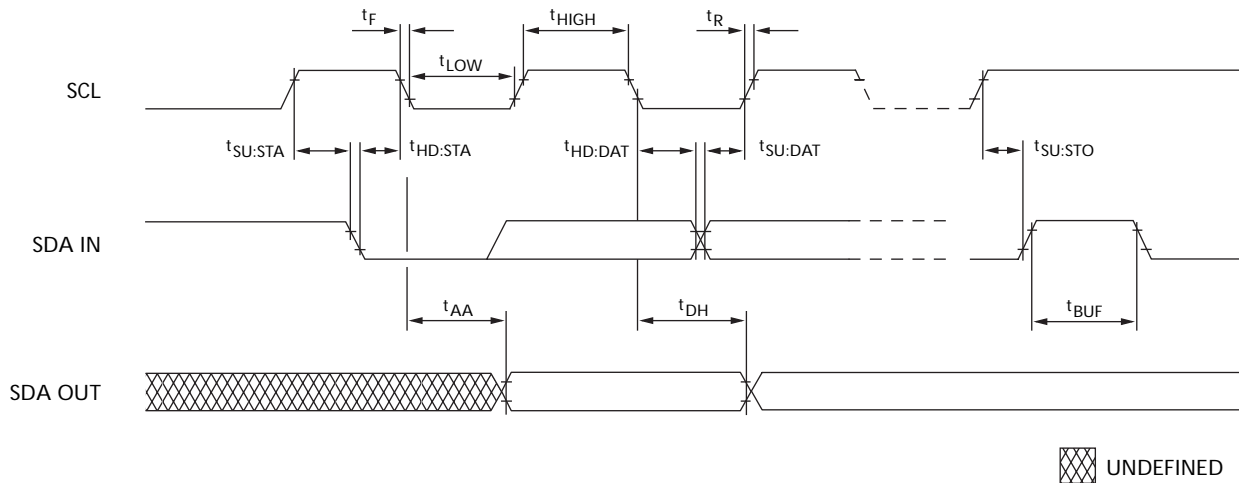

Table 20: Serial Presence-Detect EEPROM DC Operating Conditions
All voltages referenced to VSS; VDDSPD = +2.3V to +3.6V

Parameter/Condition	Symbol	Min	Max	Units
Supply voltage	VDD	3	3.6	V
Input high voltage: Logic 1; All inputs	VIH	VDD x 0.7	VDD + 0.5	V
Input low voltage: Logic 0; All inputs	VIL	-1	VDD x 0.3	V
OutInput low voltage: IOUT = 3mA	VOL	-	0.4	V
Input leakage current: VIN = GND to VDD	ILI	-10	10	μA
Output leakage current: VOUT = GND to VDD	ILO	-10	10	μA
Standby current: SCL = SDA = VDD - 0.3V; All other inputs = GND or 3.3V ±10%	Iccs	-	30	μA
Power supply current	Icc Write	-	3	mA
	Icc Read	-	1	mA

Table 21: Serial Presence-Detect EEPROM AC Operating Conditions
All voltages referenced to VSS; VDDSPD = +2.3V to +3.6V

Parameter/Condition	Symbol	Min	Max	Units	Notes
SCL LOW to SDA data-out valid	tAA	0.2	0.9	μs	1
Time the bus must be free before a new transition can start	tBUF	1.3		μs	
Data-out hold time	tDH	200		ns	
SDA and SCL fall time	tF		300	ns	2
Data-in hold time	tHD:DAT	0		μs	
Start condition hold time	tHD:STA	0.6		μs	
Clock HIGH period	tHIGH	0.6		μs	
Noise suppression time constant at SCL, SDA inputs	tI		50	ns	
Clock LOW period	tLOW	1.3		μs	
SDA and SCL rise time	tR		0.3	μs	2
SCL clock frequency	fSCL		400	KHz	
Data-in setup time	tSU:DAT	100		ns	
Start condition setup time	tSU:STA	0.6		μs	3

Table 21: Serial Presence-Detect EEPROM AC Operating Conditions (continued)

All voltages referenced to V_{SS}; V_{DDSPD} = +2.3V to +3.6V

Parameter/Condition	Symbol	Min	Max	Units	Notes
Stop condition setup time	$t_{SU:STO}$	0.6		μ s	
WRITE cycle time	t_{WRC}		10	ms	4

- Notes:
1. To avoid spurious start and stop conditions, a minimum delay is placed between SCL = 1 and the falling or rising edge of SDA.
 2. This parameter is sampled.
 3. For a restart condition or following a WRITE cycle.
 4. The SPD EEPROM WRITE cycle time (t_{WRC}) is the time from a valid stop condition of a write sequence to the end of the EEPROM internal ERASE/PROGRAM cycle. During the WRITE cycle, the EEPROM bus interface circuit is disabled, SDA remains HIGH due to pull-up resistor, and the EEPROM does not respond to its slave address.



Table 22: Serial Presence-Detect Matrix

VDD = +3.3V ±0.3V; "1"/"0": Serial Data, "driven to HIGH"/"driven to LOW"

Byte	Description	Entry (Version)	MT9LSDT6472A	MT18LSDT12872A
0	Number of bytes used by Micron	128	80	80
1	Total number of SPD memory bytes	256	08	08
2	Memory type	SDRAM	04	04
3	Number of row addresses	13	0D	0D
4	Number of column addresses	11	0B	0B
5	Number of module ranks	1 or 2	01	02
6	Module data width	72	48	48
7	Module data width (continued)	0	00	00
8	Module voltage interface levels	LVTTTL	01	01
9	SDRAM cycle time, ^t CK (CAS latency = 3)	7ns (-13E) 7.5ns (-133)	70 75	75 75
10	SDRAM access from CLK, ^t AC (CAS latency = 3)	5.4ns (-13E/-133)	54	54
11	Module configuration type	ECC	02	02
12	Refresh rate/type	7.8125µs/SELF	82	82
13	SDRAM width (primary SDRAM)	8	08	08
14	Error-checking SDRAM data width	8	08	08
15	Minimum clock delay from back-to-back random column addresses, ^t CCD	1	01	01
16	Burst lengths supported	1, 2, 4, 8, PAGE	8F	8F
17	Number of banks on SDRAM device	4	04	04
18	CAS latencies supported	2, 3	06	06
19	CS latency	0	01	01
20	WE latency	0	01	01
21	SDRAM module attributes	UNBUFFERED	00	00
22	SDRAM device attributes: General	0E	0E	0E
23	SDRAM cycle time, ^t CK (CAS latency = 2)	7.5ns (13E) 10ns (-133)	75 A0	75 A0
24	SDRAM access from CLK, ^t AC (CAS latency = 2)	5.4ns (-13E) 6ns (-133)	54 60	54 60
25	SDRAM cycle time, ^t CK (CAS latency = 1)		00	00
26	SDRAM access from CLK, ^t AC (CAS latency = 1)		00	00
27	Minimum row precharge time, ^t RP	15ns (-13E) 20ns (-133)	0F 14	0F 14
28	Minimum row active to row active, ^t RRD	14ns (-13E) 15ns (-133)	0E 0F	0E 0F
29	Minimum RAS# to CAS# delay, ^t RCD	15ns (-13E) 20ns (-133)	0F 14	0F 14
30	Minimum RAS# pulse width, ^t RAS (see note 1)	45ns (-13E) 44ns (133)	2D 2C	2D 2C
31	Module rank density	512MB	80	80
32	Command and address setup time, ^t AS, ^t CMS	1.5ns (-13E/-133)	15	15
33	Command and address hold time, ^t AH, ^t CMH	0.8ns (-13E/-133)	08	08
34	Data signal input setup time, ^t DS	1.5ns (-13E/-133)	15	15
35	Data signal input hold time, ^t DH	0.8ns (-13E/-133)	08	08

Table 22: Serial Presence-Detect Matrix (continued)

VDD = +3.3V ±0.3V; "1"/"0": Serial Data, "driven to HIGH"/"driven to LOW"

Byte	Description	Entry (Version)	MT9LSDT6472A	MT18LSDT12872A
36–40	Reserved		00	00
41	Device minimum active/auto-refresh time, t_{RC}	60ns (-13E) 66ns (-133)	3C 42	3C 42
42–61	Reserved		00	00
62	SPD revision	Rev. 2.0	02	02
63	Checksum For bytes 0–62	(-13E) (-133)	DE 24	DF 25
64	Manufacturer's JEDEC ID code	MICRON	2C	2C
65–71	Manufacturer's JEDEC ID code (continued)		FF	FF
72	Manufacturing location	1– 12	01 - 0C	01 - 0C
73–90	Module part number (ASCII)		Variable Data	Variable Data
91	PCB Identification code	1–9	01–09	01–09
92	Identification code (continued)	0	00	00
93	Year of manufacture in BCD		Variable Data	Variable Data
94	Week of manufacture in BCD		Variable Data	Variable Data
95–98	Module serial number		Variable Data	Variable Data
99–125	Manufacturer-Specific data (RSVD)			
126	System frequency	100 MHz (-13E/-133)	64	64
127	SDRAM component and clock detail		AF	FF

Notes: 1. The value of t_{RAS} used for -13E modules is calculated from $t_{RC} - t_{RP}$. Actual device specification value is 37ns.

Module Dimensions

Figure 11: 168-Pin DIMM Dimensions – 512MB

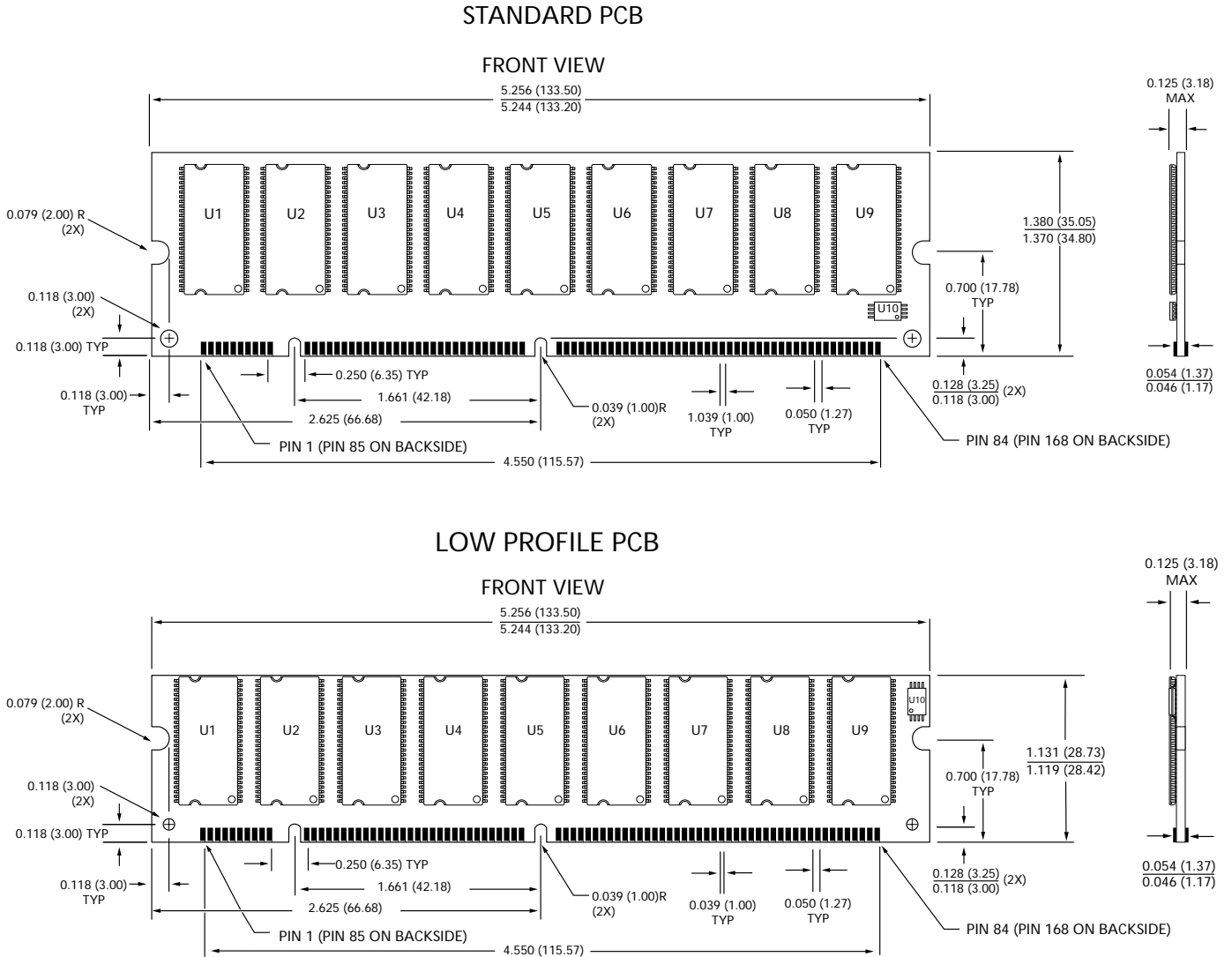

Note: All dimensions in inches (millimeters); $\frac{\text{MAX}}{\text{MIN}}$ or typical where noted.

Figure 12: 168-Pin DIMM Dimensions - 1GBs

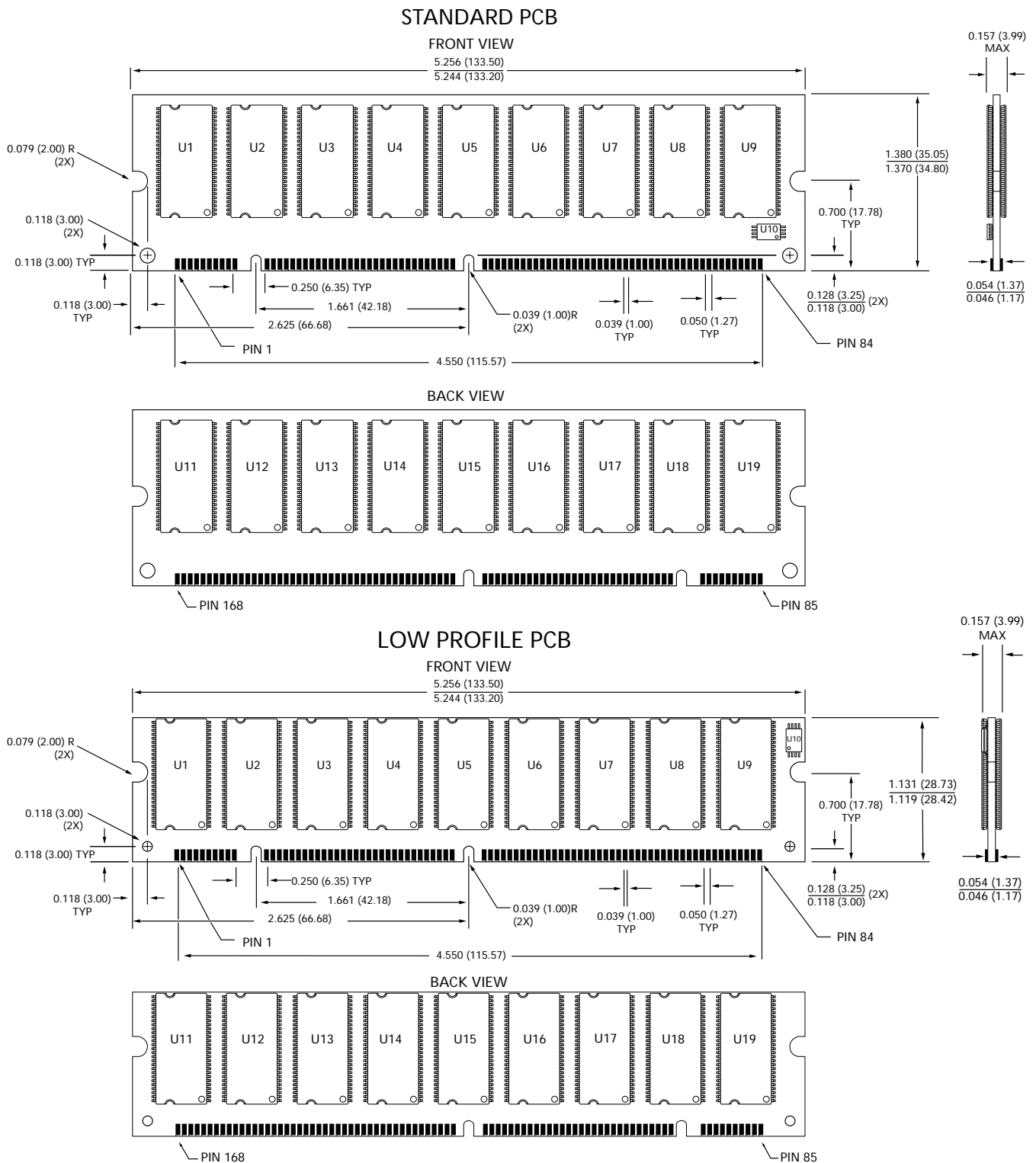

Note: All dimensions in inches (millimeters); $\frac{\text{MAX}}{\text{MIN}}$ or typical where noted.



512MB (SR), 1GB (DR): (x72, ECC) 168-Pin SDRAM UDIMM Module Dimensions



8000 S. Federal Way, P.O. Box 6, Boise, ID 83707-0006, Tel: 208-368-3900
prodmktg@micron.com www.micron.com Customer Comment Line: 800-932-4992
Micron, the M logo, and the Micron logo are trademarks of Micron Technology, Inc.
All other trademarks are the property of their respective owners.

This data sheet contains minimum and maximum limits specified over the complete power supply and temperature range for production devices. Although considered final, these specifications are subject to change, as further product development and data characterization sometimes occur.