

LINNEA-90-PMMA

~90° + 90° wide beam optimized for 1.0 mm metal sheet or profile. Variant made from PMMA.

TECHNICAL SPECIFICATIONS:

Dimensions	285.0 x 40.0 mm
Height	9.5 mm
Fastening	clips
ROHS compliant	yes ⓘ

MATERIAL SPECIFICATIONS:

Component	Type	Material	Colour	Finish
LINNEA-90-PMMA	Linear lens	PMMA	clear	



ORDERING INFORMATION:

Component	Qty in box	MOQ	MPQ	Box weight (kg)
F16811_LINNEA-90-PMMA » Box size: 578 x 378 x 295 mm	180	30	30	7.0

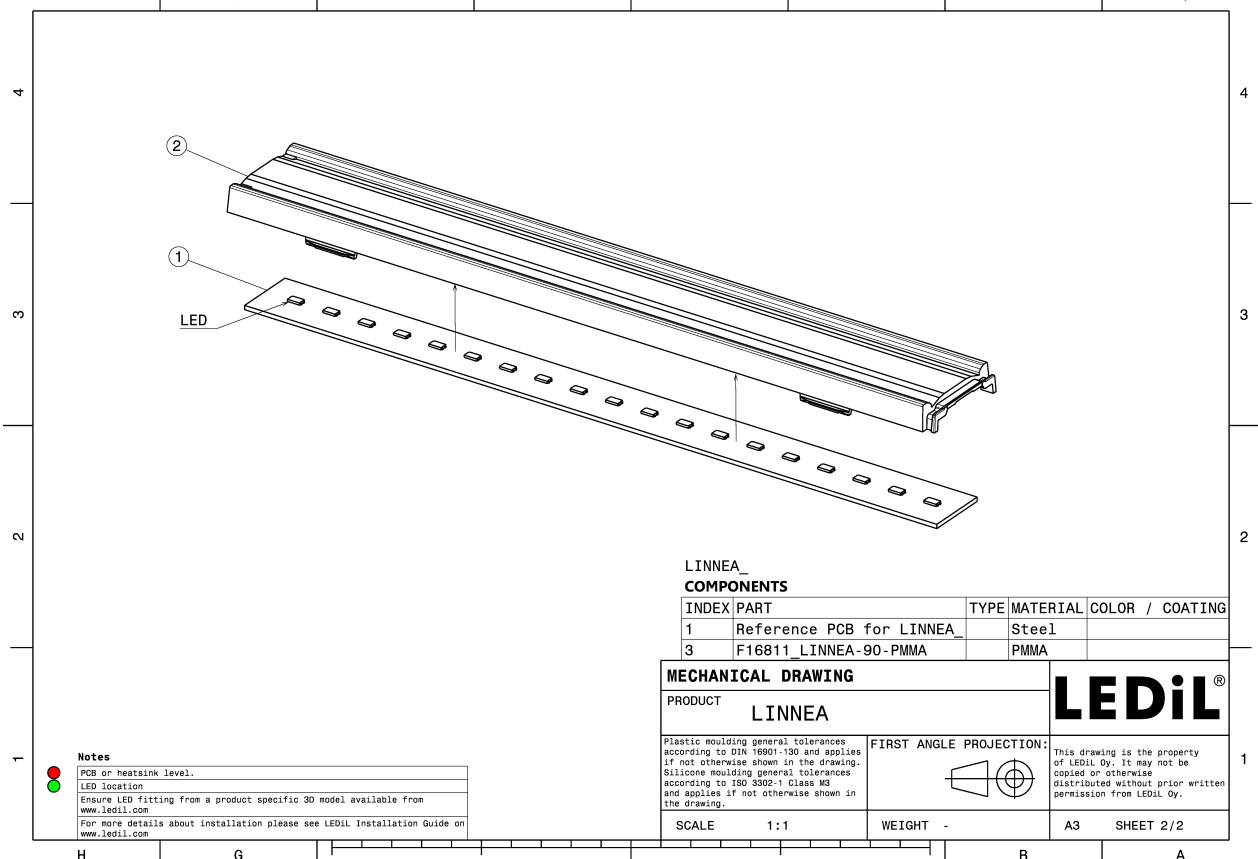
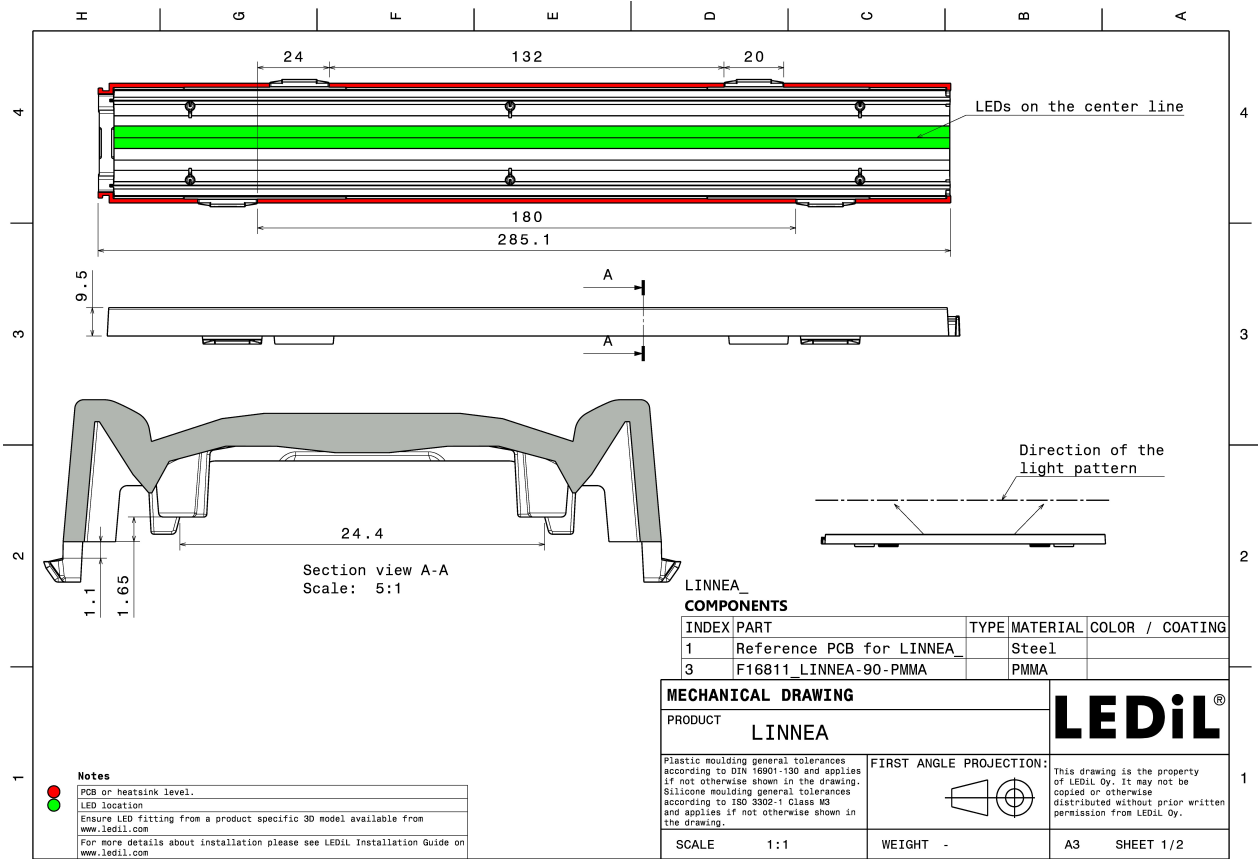

PHOTOMETRIC DATA (MEASURED):

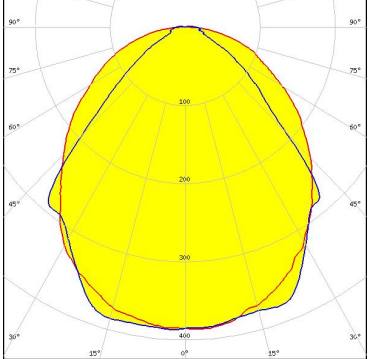
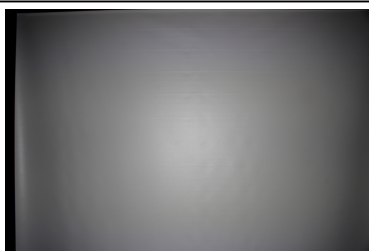
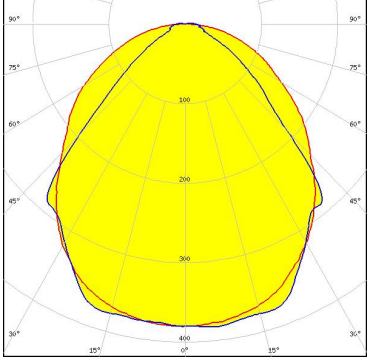
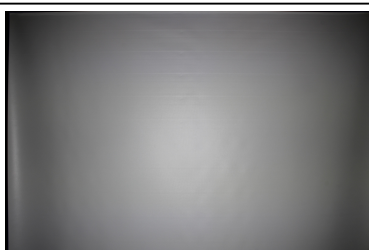
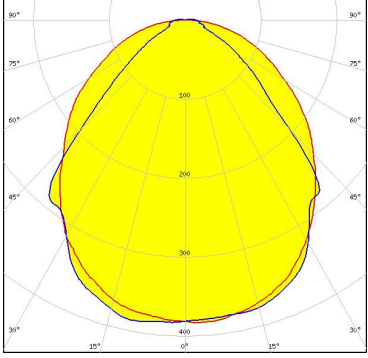
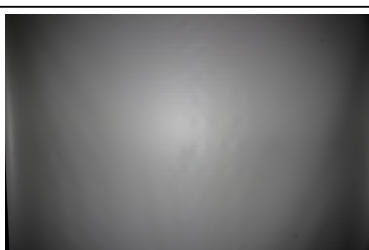
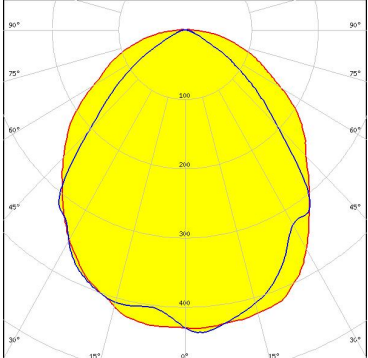
<p>Helvar</p> <p>LED LP-282-840-009A 60/300 FWHM 104.0 + 90.0° Efficiency 88 % Peak intensity 0.4 cd/lm LEDs/each optic 1 Light colour White Required components:</p>		
<p>Helvar</p> <p>LED LS-282-840-011A FWHM 106.0 + 90.0° Efficiency 88 % Peak intensity 0.4 cd/lm LEDs/each optic 1 Light colour White Required components:</p>		
<p>Helvar</p> <p>LED LX-282-840-023A FWHM 106.0 + 90.0° Efficiency 88 % Peak intensity 0.4 cd/lm LEDs/each optic 1 Light colour White Required components:</p>		
<p>NICHIA</p> <p>LED NF2x757G FWHM 106.0 + 88.0° Efficiency 92 % Peak intensity 0.4 cd/lm LEDs/each optic 1 Light colour White Required components:</p>		

PHOTOMETRIC DATA (MEASURED):



LED NFSW757H
FWHM 104.0 + 91.0°
Efficiency 88 %
Peak intensity 0.4 cd/lm
LEDs/each optic 1
Light colour White
Required components:

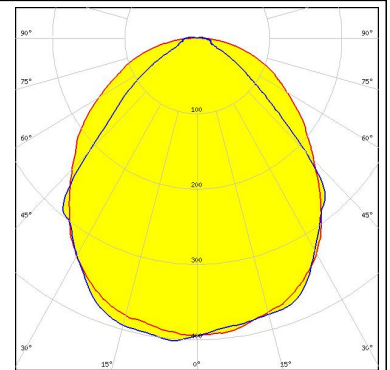

OSRAM

LED PL-LIN-IND-Z1 2800 560x24
FWHM 106.0 + 92.0°
Efficiency 93 %
Peak intensity 0.4 cd/lm
LEDs/each optic 1
Light colour White
Required components:

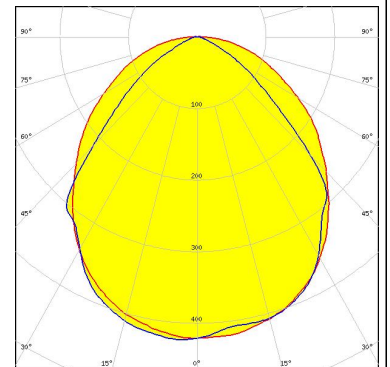

OSRAM

LED PL-LIN-Z5 1100 280x20
FWHM 104.0 + 90.0°
Efficiency 87 %
Peak intensity 0.4 cd/lm
LEDs/each optic 1
Light colour White
Required components:

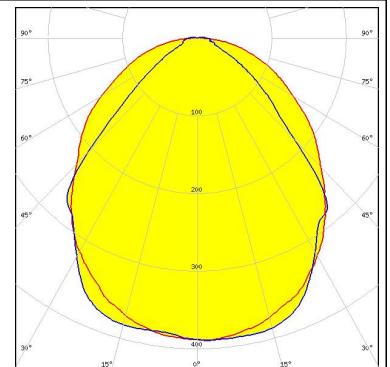
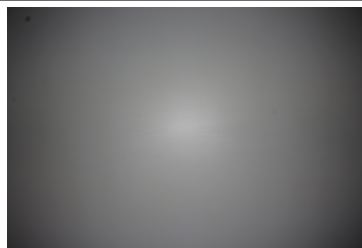

OSRAM

LED PL-LIN-Z5 2000 280x20
FWHM 104.0 + 91.0°
Efficiency 87 %
Peak intensity 0.4 cd/lm
LEDs/each optic 1
Light colour White
Required components:

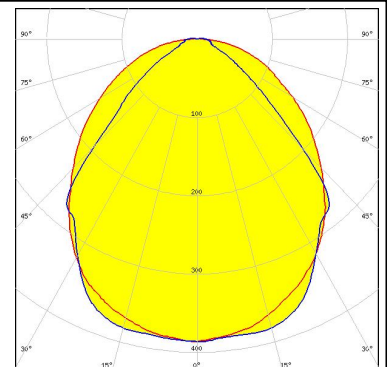
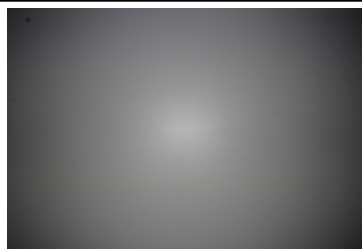

PHOTOMETRIC DATA (MEASURED):

OSRAM

Opto Semiconductors

LED Duris E 2835
FWHM 108.0 + 87.0°
Efficiency 90 %
Peak intensity 0.4 cd/lm
LEDs/each optic 1
Light colour White
Required components:

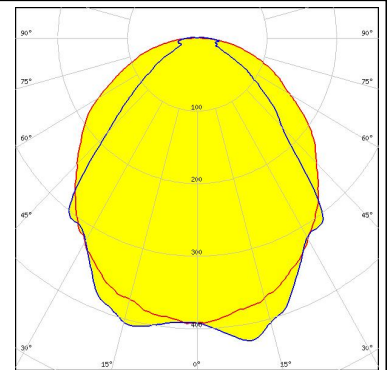

PHILIPS

LED Fortimo LED Strip 1ft 1100lm FC HV4 & LV4
FWHM 107.0 + 91.0°
Efficiency 88 %
Peak intensity 0.4 cd/lm
LEDs/each optic 1
Light colour White
Required components:

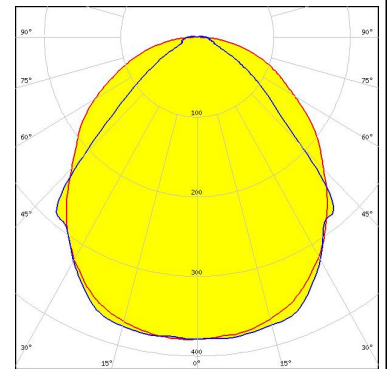
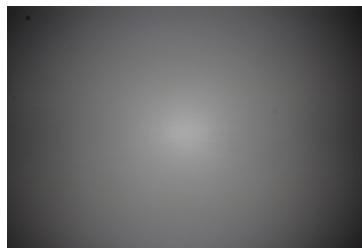

PHILIPS

LED Fortimo LED Strip 1ft 650lm FC HV4 & LV4
FWHM 103.0 + 90.0°
Efficiency 88 %
Peak intensity 0.4 cd/lm
LEDs/each optic 1
Light colour White
Required components:

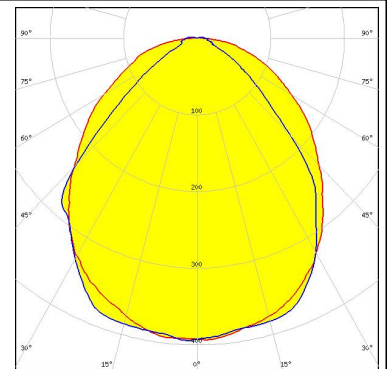
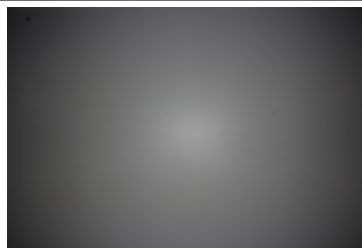

SAMSUNG

LED LM28xB Series
FWHM 107.0 + 88.0°
Efficiency 90 %
Peak intensity 0.4 cd/lm
LEDs/each optic 1
Light colour White
Required components:

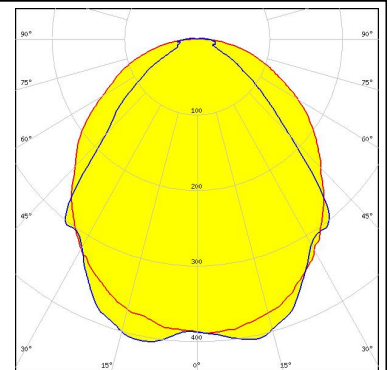
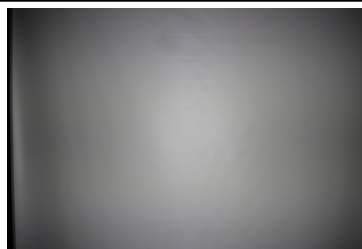

PHOTOMETRIC DATA (MEASURED):

SAMSUNG

LED LM301B
FWHM 106.0 + 91.0°
Efficiency 90 %
Peak intensity 0.4 cd/lm
LEDs/each optic 1
Light colour White
Required components:

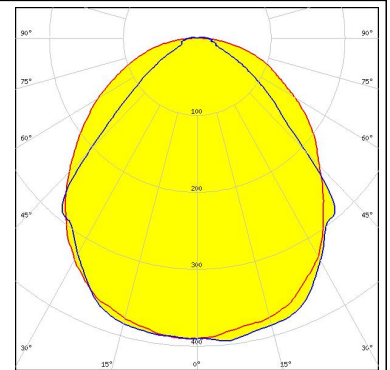
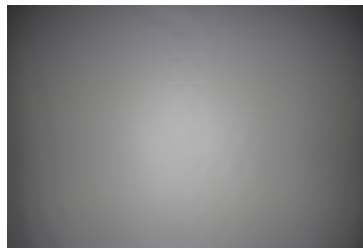

SAMSUNG

LED LM561B Plus
FWHM 105.0 + 92.0°
Efficiency 89 %
Peak intensity 0.4 cd/lm
LEDs/each optic 1
Light colour White
Required components:

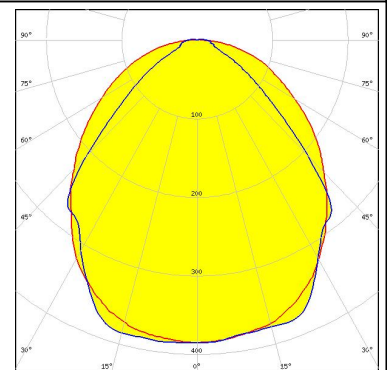
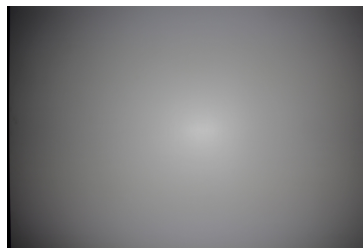

SAMSUNG

LED LT-H282C
FWHM 107.0 + 87.0°
Efficiency 89 %
Peak intensity 0.4 cd/lm
LEDs/each optic 1
Light colour White
Required components:

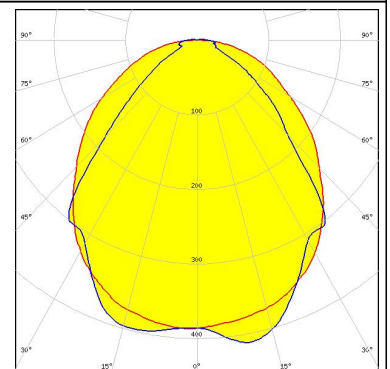
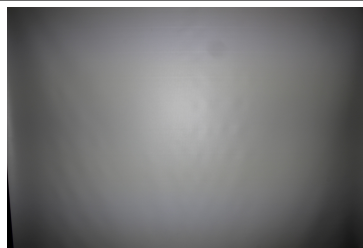

SAMSUNG

LED LT-Q282B
FWHM 106.0 + 87.0°
Efficiency 89 %
Peak intensity 0.4 cd/lm
LEDs/each optic 1
Light colour White
Required components:

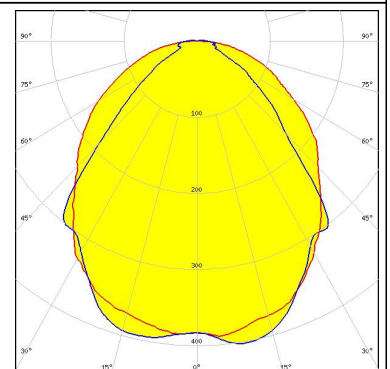
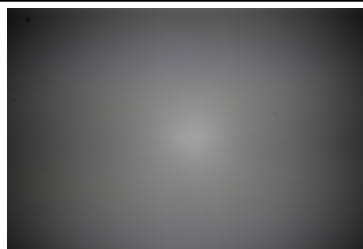

PHOTOMETRIC DATA (MEASURED):

SAMSUNG

LED LT-V282E
FWHM 105.0 + 88.0°
Efficiency 89 %
Peak intensity 0.4 cd/lm
LEDs/each optic 1
Light colour White
Required components:

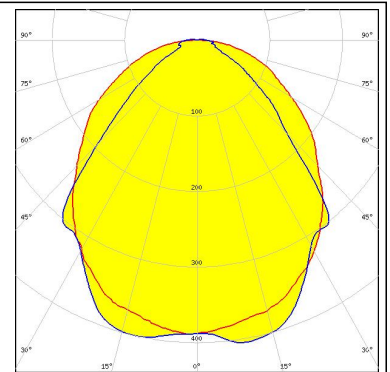

TRIDONIC

LED LLE 24x280mm 1250lm HV ADV5
FWHM 106.0 + 90.0°
Efficiency 88 %
Peak intensity 0.4 cd/lm
LEDs/each optic 1
Light colour White
Required components:

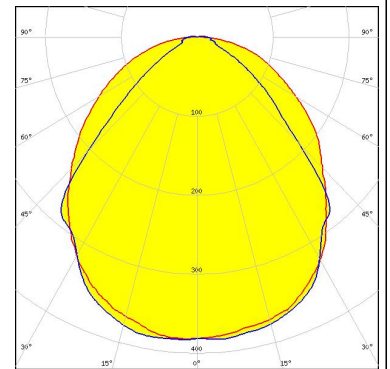
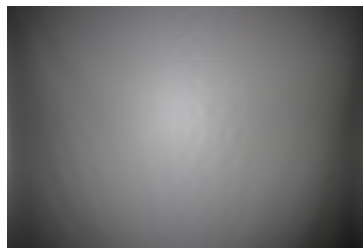

TRIDONIC

LED LLE 24x280mm 650lm HV ADV5
FWHM 104.0 + 91.0°
Efficiency 88 %
Peak intensity 0.4 cd/lm
LEDs/each optic 1
Light colour White
Required components:

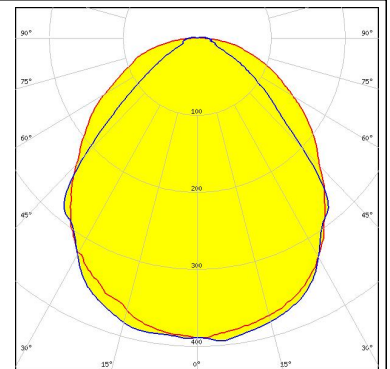
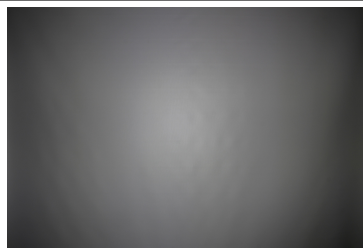

PHOTOMETRIC DATA (SIMULATED):

	
SEOUL SEMICONDUCTOR	
LED	SEOUL DC 3030C
FWHM	96.0 + 88.0°
Efficiency	84 %
Peak intensity	0.4 cd/lm
LEDs/each optic	1
Light colour	White
Required components:	

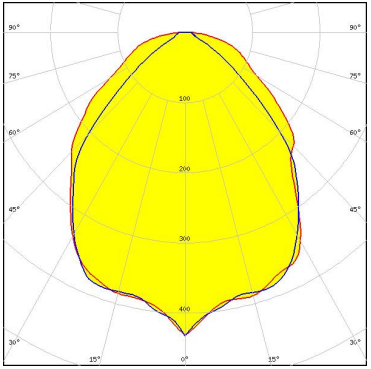

GENERAL INFORMATION:

NOTE: The typical beam angle will be changed by different color, chip size and chip position tolerance. The typical total beam angle is the full angle measured where the luminous intensity is half of the peak value.

MATERIALS:

As part of our continuous research and improvement processes, and to ensure the best possible quality and availability of our products, LEDiL reserves the right to change material grades without notice.

PRODUCT DATA USER AGREEMENT AND DISCLAIMER:

The measured data in the provided downloadable LEDiL Product Datasheets and Mechanical 2D-Drawings is rounded and provided as reference for planning. LEDiL Oy's optical specifications have been verified by conducting performance testing of the products in accordance with the company's quality system. The reported data are averaged results of multiple measurements with typical variation. LEDiL Oy reserves the right to without prior notification make changes and improvements to its products.

LEDiL Oy assumes neither warranty, nor guarantee nor any other liability of any kind for the contents and correctness of the provided data. The provided data has been generated with highest diligence but the provided data may in reality not represent the complete possible variation range of all intrinsic parameters. Therefore, in certain cases a deviation from the provided data could occur.

LEDiL Oy reserves the right to undertake technical changes of its products without further notification which could lead to changes in the provided data. LEDiL Oy assumes no liability of any kind for the possible deviation from any provided data or any other damage resulting from the usage of the provided data.

The user agrees to this disclaimer and user agreement with the download or usage of the provided files.

LEDiL Oy

Joensuunkatu 13
FI-24240 SALO
Finland

LEDiL Inc.

228 West Page Street
Suite D
Sycamore IL 60178
USA

Local sales and technical support

[www.ledil.com/
where_to_buy](http://www.ledil.com/where_to_buy)

Shipping locations

Salo, Finland
Hong Kong, China

Distribution Partners

[www.ledil.com/
where_to_buy](http://www.ledil.com/where_to_buy)