

## ANNA-40-7-S

~15° spot beam with 7 optics

### TECHNICAL SPECIFICATIONS:

Dimensions	Ø 40.0 mm
Height	10.7 mm
Fastening	pin
ROHS compliant	yes 

### MATERIAL SPECIFICATIONS:

Component	Type	Material	Colour	Finish
ANNA-40-7-S	Multi-lens	PMMA	clear	



### ORDERING INFORMATION:

Component	Qty in box	MOQ	MPQ	Box weight (kg)
C13483_ANNA-40-7-S » Box size: 480 x 280 x 300 mm	760	120	40	8.2

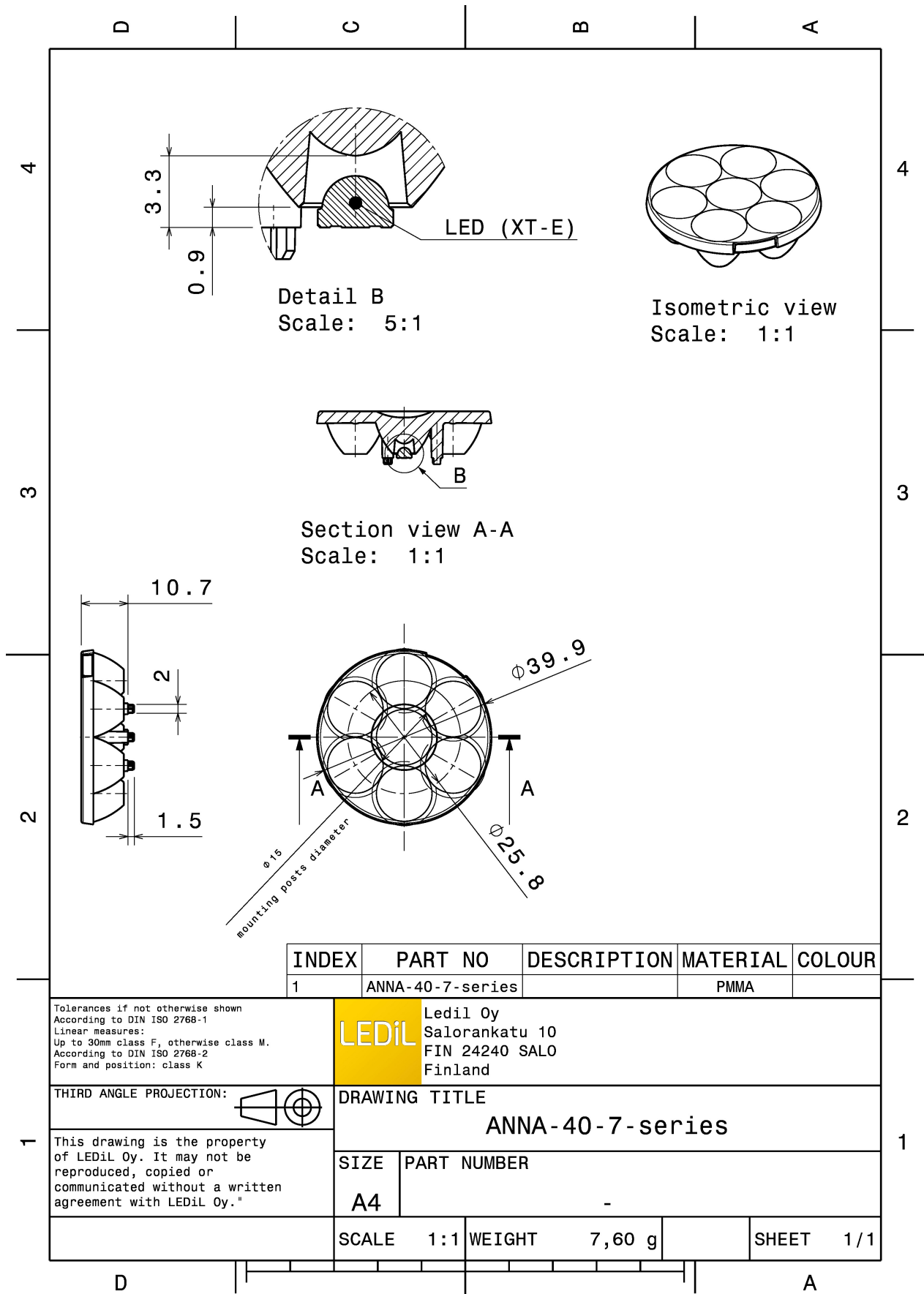

### PHOTOMETRIC DATA (MEASURED):

**CREE** 

LED XP-E2  
FWHM 12.0°  
Efficiency 87 %  
Peak intensity 13.8 cd/lm  
LEDs/each optic 1  
Light colour White  
Required components:

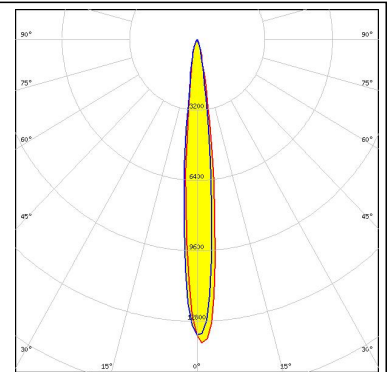

**CREE** 

LED XP-G2  
FWHM 17.0°  
Efficiency 91 %  
Peak intensity 7.6 cd/lm  
LEDs/each optic 1  
Light colour White  
Required components:

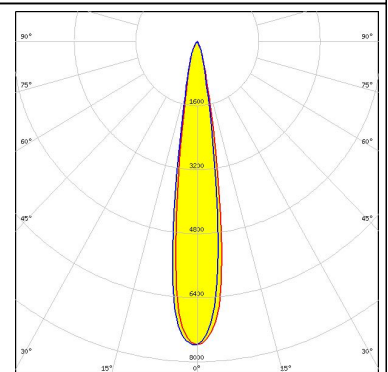

**CREE** 

LED XT-E  
FWHM 16.0°  
Efficiency 89 %  
Peak intensity 7.3 cd/lm  
LEDs/each optic 1  
Light colour White  
Required components:

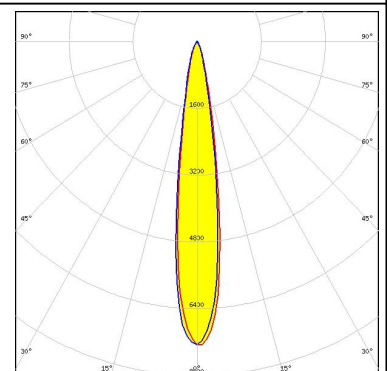

#### PHOTOMETRIC DATA (SIMULATED):

<p>bridgelux</p> <p>LED SM4            FWHM 33.0°            Efficiency 87 %            Peak intensity 2.1 cd/lm            LEDs/each optic 1            Light colour White            Required components:</p>	
<p><b>CREE</b></p> <p>LED J Series 2835            FWHM 14.0°            Efficiency 96 %            Peak intensity 9.1 cd/lm            LEDs/each optic 1            Light colour White            Required components:</p>	
<p><b>CREE</b></p> <p>LED XB-D            FWHM 13.0°            Efficiency 90 %            Peak intensity 12 cd/lm            LEDs/each optic 1            Light colour White            Required components:</p>	
<p><b>CREE</b></p> <p>LED XP-E            FWHM 11.0°            Efficiency 93 %            Peak intensity 17.4 cd/lm            LEDs/each optic 1            Light colour White            Required components:</p>	

#### PHOTOMETRIC DATA (SIMULATED):



LED XP-G  
 FWHM 15.0°  
 Efficiency 93 %  
 Peak intensity 9.3 cd/lm  
 LEDs/each optic 1  
 Light colour White  
 Required components:

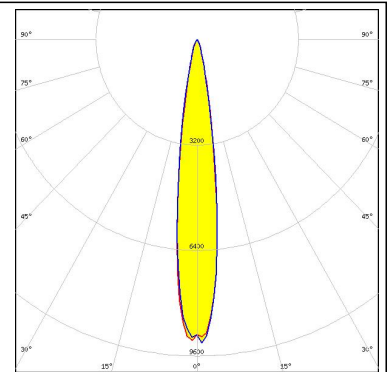

LED XP-L HD  
 FWHM 22.0°  
 Efficiency 92 %  
 Peak intensity 4.4 cd/lm  
 LEDs/each optic 1  
 Light colour White  
 Required components:

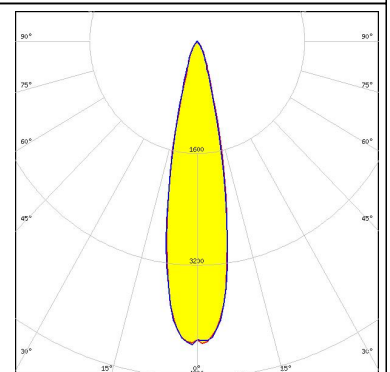

LED H35C0 (LEMWA33)  
 FWHM 16.0°  
 Efficiency 92 %  
 Peak intensity 7.3 cd/lm  
 LEDs/each optic 1  
 Light colour White  
 Required components:

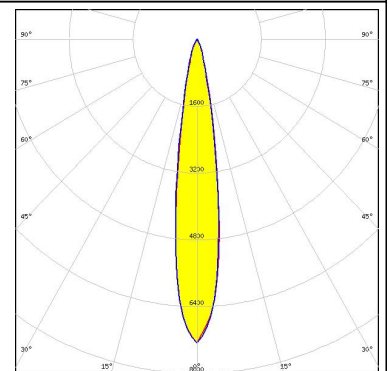

LED LUXEON PWT  
 FWHM 17.0°  
 Efficiency 88 %  
 Peak intensity 7.6 cd/lm  
 LEDs/each optic 1  
 Light colour White  
 Required components:

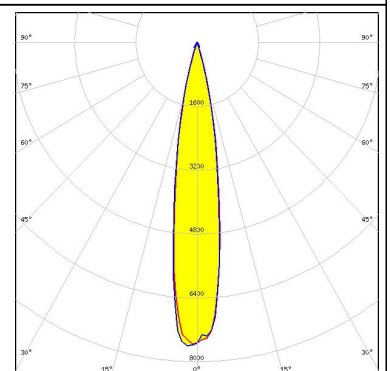

#### PHOTOMETRIC DATA (SIMULATED):

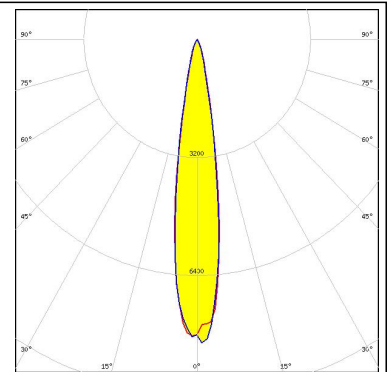
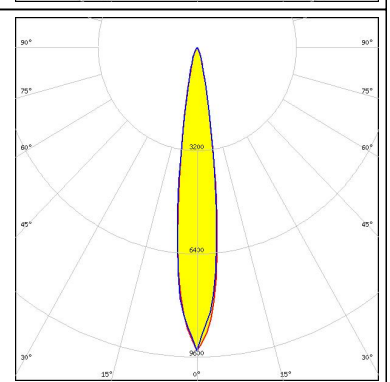
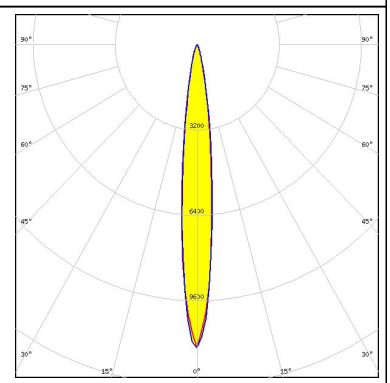
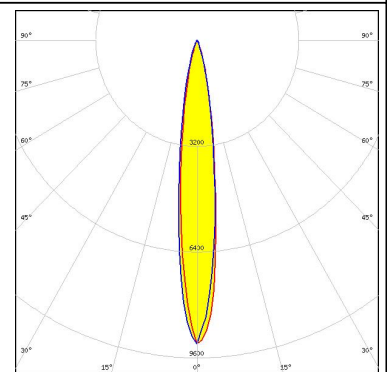
<p><b>LUMILEDS</b></p> <p>LED: LUXEON T            FWHM: 17.0°            Efficiency: 92 %            Peak intensity: 8.5 cd/lm            LEDs/each optic: 1            Light colour: White            Required components:</p>	
<p><b>LUMILEDS</b></p> <p>LED: LUXEON TX            FWHM: 15.0°            Efficiency: 93 %            Peak intensity: 9.4 cd/lm            LEDs/each optic: 1            Light colour: White            Required components:</p>	
<p><b>NICHIA</b></p> <p>LED: NCSxx19A            FWHM: 17.0°            Efficiency: 87 %            Peak intensity: 7.7 cd/lm            LEDs/each optic: 1            Light colour: White            Required components:</p>	
<p><b>NICHIA</b></p> <p>LED: NF2x757A            FWHM: 14.0°            Efficiency: 92 %            Peak intensity: 9.2 cd/lm            LEDs/each optic: 1            Light colour: White            Required components:</p>	

#### PHOTOMETRIC DATA (SIMULATED):

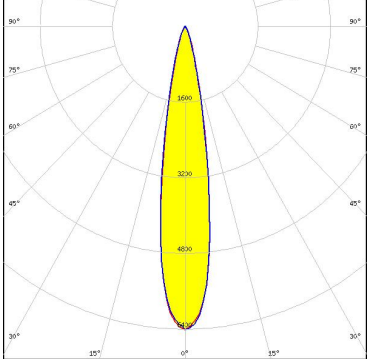
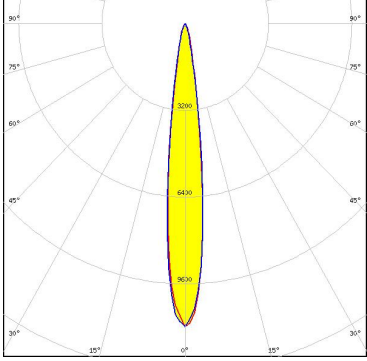
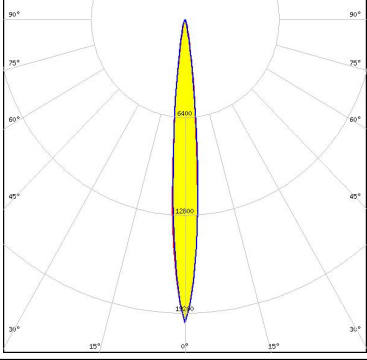
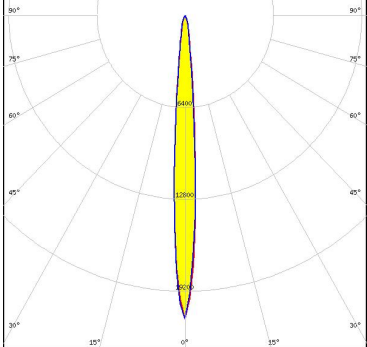
<p><b>NICHIA</b></p> <p>LED: NVSxx19B/NVSxx19C            FWHM: 18.0°            Efficiency: 92 %            Peak intensity: 6.3 cd/lm            LEDs/each optic: 1            Light colour: White            Required components:</p>	
<p><b>OSRAM</b> Opto Semiconductors</p> <p>LED: OSOLON Square EC            FWHM: 13.0°            Efficiency: 92 %            Peak intensity: 11.2 cd/lm            LEDs/each optic: 1            Light colour: White            Required components:</p>	
<p><b>OSRAM</b> Opto Semiconductors</p> <p>LED: OSOLON SSL 150            FWHM: 10.0°            Efficiency: 92 %            Peak intensity: 19.8 cd/lm            LEDs/each optic: 1            Light colour: White            Required components:</p>	
<p><b>OSRAM</b> Opto Semiconductors</p> <p>LED: OSOLON SSL 80            FWHM: 8.0°            Efficiency: %            Peak intensity: 21.1 cd/lm            LEDs/each optic: 1            Light colour: White            Required components:</p>	

### PHOTOMETRIC DATA (SIMULATED):

#### OSRAM

Opto Semiconductors

LED SFH 4715S  
 FWHM 13.0°  
 Efficiency 90 %  
 Peak intensity 11.7 cd/lm  
 LEDs/each optic 1  
 Light colour White  
 Required components:

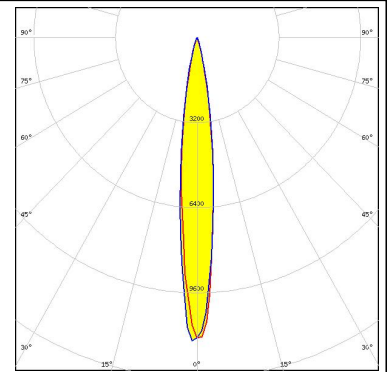

#### SEKUL

SEOUL SEMICONDUCTOR

LED Z8Y22P  
 FWHM 18.0°  
 Efficiency 90 %  
 Peak intensity 5.5 cd/lm  
 LEDs/each optic 1  
 Light colour White  
 Required components:

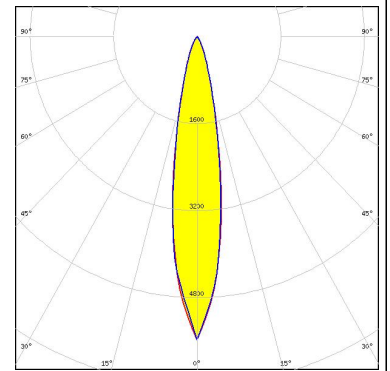

#### SHARP

LED Double Dome (GM2BB)  
 FWHM 13.0°  
 Efficiency 89 %  
 Peak intensity 10 cd/lm  
 LEDs/each optic 1  
 Light colour White  
 Required components:

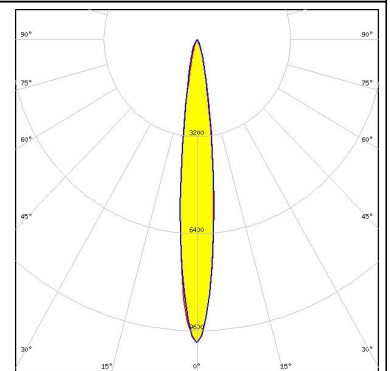



### GENERAL INFORMATION:

NOTE: The typical beam angle will be changed by different color, chip size and chip position tolerance. The typical total beam angle is the full angle measured where the luminous intensity is half of the peak value.

### MATERIALS:

As part of our continuous research and improvement processes, and to ensure the best possible quality and availability of our products, LEDiL reserves the right to change material grades without notice.

### PRODUCT DATA USER AGREEMENT AND DISCLAIMER:

The measured data in the provided downloadable LEDiL Product Datasheets and Mechanical 2D-Drawings is rounded and provided as reference for planning. LEDiL Oy's optical specifications have been verified by conducting performance testing of the products in accordance with the company's quality system. The reported data are averaged results of multiple measurements with typical variation. LEDiL Oy reserves the right to without prior notification make changes and improvements to its products.

LEDiL Oy assumes neither warranty, nor guarantee nor any other liability of any kind for the contents and correctness of the provided data. The provided data has been generated with highest diligence but the provided data may in reality not represent the complete possible variation range of all intrinsic parameters. Therefore, in certain cases a deviation from the provided data could occur.

LEDiL Oy reserves the right to undertake technical changes of its products without further notification which could lead to changes in the provided data. LEDiL Oy assumes no liability of any kind for the possible deviation from any provided data or any other damage resulting from the usage of the provided data.

The user agrees to this disclaimer and user agreement with the download or usage of the provided files.

#### LEDiL Oy

Joensuunkatu 13  
FI-24240 SALO  
Finland

#### LEDiL Inc.

228 West Page Street  
Suite D  
Sycamore IL 60178  
USA

#### Local sales and technical support

[www.ledil.com/  
where\\_to\\_buy](http://www.ledil.com/where_to_buy)

#### Shipping locations

Salo, Finland  
Hong Kong, China

#### Distribution Partners

[www.ledil.com/  
where\\_to\\_buy](http://www.ledil.com/where_to_buy)