

Intel® Celeron® Mobile Processor Dual-Core on 45-nm Process

Datasheet

*For Platforms Based on Mobile Intel® 4 Series Express Chipset Family
September 2009*

Document Number: 321111-003



INFORMATION IN THIS DOCUMENT IS PROVIDED IN CONNECTION WITH INTEL® PRODUCTS. NO LICENSE, EXPRESS OR IMPLIED, BY ESTOPPEL OR OTHERWISE, TO ANY INTELLECTUAL PROPERTY RIGHTS IS GRANTED BY THIS DOCUMENT. EXCEPT AS PROVIDED IN INTEL'S TERMS AND CONDITIONS OF SALE FOR SUCH PRODUCTS, INTEL ASSUMES NO LIABILITY WHATSOEVER, AND INTEL DISCLAIMS ANY EXPRESS OR IMPLIED WARRANTY, RELATING TO SALE AND/OR USE OF INTEL PRODUCTS INCLUDING LIABILITY OR WARRANTIES RELATING TO FITNESS FOR A PARTICULAR PURPOSE, MERCHANTABILITY, OR INFRINGEMENT OF ANY PATENT, COPYRIGHT OR OTHER INTELLECTUAL PROPERTY RIGHT.

UNLESS OTHERWISE AGREED IN WRITING BY INTEL, THE INTEL PRODUCTS ARE NOT DESIGNED NOR INTENDED FOR ANY APPLICATION IN WHICH THE FAILURE OF THE INTEL PRODUCT COULD CREATE A SITUATION WHERE PERSONAL INJURY OR DEATH MAY OCCUR.

Intel may make changes to specifications and product descriptions at any time, without notice. Designers must not rely on the absence or characteristics of any features or instructions marked "reserved" or "undefined." Intel reserves these for future definition and shall have no responsibility whatsoever for conflicts or incompatibilities arising from future changes to them. The information here is subject to change without notice. Do not finalize a design with this information.

The products described in this document may contain design defects or errors known as errata which may cause the product to deviate from published specifications. Current characterized errata are available on request.

Contact your local Intel sales office or your distributor to obtain the latest specifications and before placing your product order.

Enabling Execute Disable Bit functionality requires a PC with a processor with Execute Disable Bit capability and a supporting operating system. Check with your PC manufacturer on whether your system delivers Execute Disable Bit functionality.

Enhanced Intel SpeedStep® Technology for specified units of this processor is available. See the Processor Spec Finder at <http://processorfinder.intel.com> or contact your Intel representative for more information.

Intel® Virtualization Technology requires a computer system with an enabled Intel® processor, BIOS, virtual machine monitor (VMM) and, for some uses, certain platform software enabled for it. Functionality, performance or other benefits will vary depending on hardware and software configurations and may require a BIOS update. Software applications may not be compatible with all operating systems. Please check with your application vendor.

This device is protected by U.S. patent numbers 5,315,448 and 6,516,132, and other intellectual property rights. The use of Macrovision's copy protection technology in the device must be authorized by Macrovision and is intended for home and other limited pay-per-view uses only, unless otherwise authorized in writing by Macrovision. Reverse engineering or disassembly is prohibited.

64-bit computing on Intel architecture requires a computer system with a processor, chipset, BIOS, operating system, device drivers and applications enabled for Intel® 64 architecture. Processors will not operate (including 32-bit operation) without an Intel® 64 architecture-enabled BIOS. Performance will vary depending on your hardware and software configurations. Consult with your system vendor for more information.

Intel, Pentium, Intel Core, Intel Core 2, Intel SpeedStep and the Intel logo are trademarks of Intel Corporation in the U.S. and other countries.

*Other names and brands may be claimed as the property of others.

Copyright © 2008, Intel Corporation. All rights reserved.

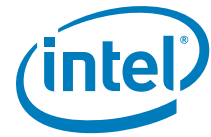

Contents

1	Introduction	7
1.1	Terminology	8
1.2	References	9
2	Low Power Features	11
2.1	Clock Control and Low Power States	11
2.1.1	Core Low-Power States	12
2.1.2	Package Low-Power States	13
2.2	Low-Power FSB Features	15
2.3	Processor Power Status Indicator (PSI#) Signal	15
3	Electrical Specifications	17
3.1	Power and Ground Pins	17
3.2	FSB Clock (BCLK[1:0]) and Processor Clocking	17
3.3	Voltage Identification	17
3.4	Catastrophic Thermal Protection	20
3.5	Reserved and Unused Pins	20
3.6	FSB Frequency Select Signals (BSEL[2:0])	21
3.7	FSB Signal Groups	21
3.8	CMOS Signals	23
3.9	Maximum Ratings	23
3.10	Processor DC Specifications	24
4	Package Mechanical Specifications and Pin Information	29
4.1	Package Mechanical Specifications	29
4.2	Processor Pinout and Pin List	33
4.3	Alphabetical Signals Reference	53
5	Thermal Specifications and Design Considerations	61
5.1	Monitoring Die Temperature	61
5.1.1	Thermal Diode	62
5.1.2	Thermal Diode Offset	64
5.1.3	Intel® Thermal Monitor	65
5.1.4	Digital Thermal Sensor	66
5.1.5	Out of Specification Detection	67
5.1.6	PROCHOT# Signal Pin	67



Figures

1	Package-Level Low-Power States	11
2	Core Low-Power States	12
3	4-MB and Fused 2-MB Micro-FCPGA Processor Package Drawing (Sheet 1 of 2)	30
4	4-MB and Fused 2-MB Micro-FCPGA Processor Package Drawing (Sheet 2 of 2)	31
5	2-MB Micro-FCPGA Processor Package Drawing (Sheet 1 of 2)	32
6	2-MB Micro-FCPGA Processor Package Drawing (Sheet 2 of 2)	33

Tables

1	Coordination of Core-Level Low-Power States at the Package Level	11
2	Voltage Identification Definition	17
3	BSEL[2:0] Encoding for BCLK Frequency	21
4	FSB Pin Groups	22
5	Processor Absolute Maximum Ratings	23
6	DC Voltage and Current Specifications	25
7	FSB Differential BCLK Specifications	26
8	AGTL+ Signal Group DC Specifications	27
9	CMOS Signal Group DC Specifications	28
10	Open Drain Signal Group DC Specifications	28
11	The Coordinates of the Processor Pins as Viewed from the Top of the Package (Sheet 1 of 2)	34
12	The Coordinates of the Processor Pins as Viewed from the Top of the Package (Sheet 2 of 2)	35
13	Pin Listing by Pin Name	37
14	Pin Listing by Pin Number	44
15	Signal Description	53
16	Power Specifications for the Intel Celeron Dual-Core Processor - Standard Voltage	61
17	Thermal Diode Interface	62
18	Thermal Diode Parameters Using Diode Model	63
19	Thermal Diode Parameters Using Transistor Model	64
20	Thermal Diode ntrim and Diode Correction Toffset	65



Revision History

Document Number	Revision Number	Description	Date
321111	-001	<ul style="list-style-type: none">Initial Release	November 2008
321111	-002	<ul style="list-style-type: none">Added T3000, T3100, T3300, and T3500 processors	June 2009
321111	-003	<ul style="list-style-type: none">Added specifications for SFF processor SU2300Added C4 state support information for SU2300 SFF processorAdded Speedstep technology support information for SU2300 SFF processordetails:Chapter 1: updated feature list for SFF processorSection 2.1: added C4/deeper sleep state informationFigure 1: updated C4/deeper sleep state informationFigure 2: updated C4/deeper sleep state informationTable 1: Added C4/deeper sleep state informationSection 2.1.1.6, Section 2.1.2.6: Added C4/deeper sleep state informationSection 2.2: Added information on Intel speedstep technology descriptionTable 8: added table for SU2300 processor DC specificationsTable 25: added table for SU2300 thermal specificationsFigure 7, Table 19, Table 20, Table 17, Table 23 added SU2300 pin and package information	September 2009

§

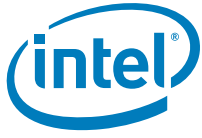



1 Introduction

This document provides electrical, mechanical, and thermal specifications for the Intel® Celeron® Mobile Processor Dual-Core T1x00, Intel(R) Celeron Processors T3x00 and Intel(R) Celeron Dual-core SFF Processors. The processor supports the Mobile Intel® 4 Series Express Chipset and Intel® 82801IBM (ICH9M) Controller-Hub Based Systems.

Note: In this document, the Celeron processor is referred to as the processor and Mobile Intel® 4 Series Express Chipset family is referred to as the (G)MCH.

The following list provides some of the key features on this processor:

- Dual-Core processor for mobile with enhanced performance
- Intel architecture with Intel® Wide Dynamic Execution
- L1 Cache to Cache (C2C) transfer
- On-die, primary 32-KB instruction cache and 32-KB write-back data cache in each core
- On-die, 1-MB second level shared cache with advanced transfer cache architecture
- Streaming SIMD Extensions 2 (SSE2), Streaming SIMD Extensions 3 (SSE3) and Supplemental Streaming SIMD Extensions 3 (SSSE3)
- 667-MHz Source-Synchronous Front Side Bus (FSB) for the T1x00 Series, and 800-MHz Source-Synchronous Front Side Bus (FSB) for the T3x00 Series processors and SFF processors
- Digital Thermal Sensor (DTS)
- Intel® 64 Technology
- PSI2 functionality
- Execute Disable Bit support for enhanced security
- Half ratio support (N/2) for Core to Bus ratio
- Supports enhanced Intel® Virtualization Technology (SFF processor only)
- Intel® Deeper Sleep low-power state with P_LVL4 I/O Support (SFF processor only)
- Advanced power management feature includes Enhanced Intel SpeedStep® Technology (SFF processor only)



1.1 Terminology

Term	Definition
#	A “#” symbol after a signal name refers to an active low signal, indicating a signal is in the active state when driven to a low level. For example, when RESET# is low, a reset has been requested. Conversely, when NMI is high, a nonmaskable interrupt has occurred. In the case of signals where the name does not imply an active state but describes part of a binary sequence (such as <i>address</i> or <i>data</i>), the “#” symbol implies that the signal is inverted. For example, D[3:0] = “HLHL” refers to a hex ‘A’, and D[3:0]# = “LHLH” also refers to a hex “A” (H= High logic level, L= Low logic level). XXXX means that the specification or value is yet to be determined.
Front Side Bus (FSB)	Refers to the interface between the processor and system core logic (also known as the chipset components).
AGTL+	Advanced Gunning Transceiver Logic. Used to refer to Assisted GTL+ signaling technology on some Intel processors.
Storage Conditions	Refers to a non-operational state. The processor may be installed in a platform, in a tray, or loose. Processors may be sealed in packaging or exposed to free air. Under these conditions, processor landings should not be connected to any supply voltages, have any I/Os biased or receive any clocks. Upon exposure to “free air” (i.e., unsealed packaging or a device removed from packaging material) the processor must be handled in accordance with moisture sensitivity labeling (MSL) as indicated on the packaging material.
Enhanced Intel SpeedStep® Technology	Technology that provides power management capabilities to laptops.
Processor Core	Processor core die with integrated L1 and L2 cache. All AC timing and signal integrity specifications are at the pads of the processor core.
Intel® 64 Technology	64-bit memory extensions to the IA-32 architecture.
Intel® Virtualization Technology	Processor virtualization which when used in conjunction with Virtual Machine Monitor software enables multiple, robust independent software environments inside a single platform.
TDP	Thermal Design Power
V _{CC}	The processor core power supply
V _{SS}	The processor ground



1.2 References

Material and concepts available in the following documents may be beneficial when reading this document.

Document	Document Number
<i>Intel® Celeron® Dual-Core T1x00 Processors Specification Update for Platforms Based on Mobile Intel® 4 Series Express Chipset Family</i>	See http://www.intel.com/design/mobile/specupdt/319734.htm
<i>Mobile Intel® 4 Series Express Chipset Family Datasheet</i>	355969
<i>Mobile Intel® 4 Series Express Chipset Family Specification Update</i>	320123
<i>Intel® I/O Controller Hub 9 (ICH9)/ I/O Controller Hub 9M (ICH9M) Datasheet</i>	See http://www.intel.com/Assets/PDF/datasheet/316972.pdf
<i>Intel® I/O Controller Hub 8 (ICH8)/ I/O Controller Hub 8M (ICH8M) Specification Update</i>	See http://www.intel.com/Assets/PDF/specupdate/316973.pdf
<i>Intel® 64 and IA-32 Architectures Software Developer's Manual</i>	See http://www.intel.com/design/pentium4/manuals/index_new.htm
<i>Intel® 64 and IA-32 Architectures Software Developer's Manuals Documentation Change</i>	See http://developer.intel.com/design/processor/specupdt/252046.htm
<i>Volume 1: Basic Architecture</i>	253665
<i>Volume 2A: Instruction Set Reference, A-M</i>	253666
<i>Volume 2B: Instruction Set Reference, N-Z</i>	253667
<i>Volume 3A: System Programming Guide</i>	253668
<i>Volume 3B: System Programming Guide</i>	253669





2 Low Power Features

2.1 Clock Control and Low Power States

The processor supports the C1/AutoHALT, C1/MWAIT, C2, C3 and some support the C4 core low-power states, along with their corresponding package-level states for power management. See Chapter 3 to see if C4 is supported. These package states include Normal, Stop Grant, Stop Grant Snoop, Sleep, and Deep Sleep. The processor’s central power management logic enters a package low-power state by initiating a P_LVLx (P_LVL2, P_LVL3, P_LVL4) I/O read to the (G)MCH. Figure 1 shows the package-level low-power states and Figure 2 shows the core low-power states. Refer to Table 1 for a mapping of core low-power states to package low-power states.

The processor implements two software interfaces for requesting low-power states: MWAIT instruction extensions with sub-state hints and P_LVLx reads to the ACPI P_BLK register block mapped in the processor’s I/O address space. The P_LVLx I/O reads are converted to equivalent MWAIT C-state requests inside the processor and do not directly result in I/O reads on the processor FSB. The monitor address does not need to be setup before using the P_LVLx I/O read interface. The sub-state hints used for each P_LVLx read can be configured through the IA32_MISC_ENABLES Model Specific Register (MSR).

If the processor encounters a chipset break event while STPCLK# is asserted, it asserts the PBE# output signal. Assertion of PBE# when STPCLK# is asserted indicates to system logic that the processor should return to the Normal state.

Table 1. Coordination of Core-Level Low-Power States at the Package Level

Core States	Package States
C0	Normal
C1 ⁽¹⁾	Normal
C2	Stop Grant
C3	Deep Sleep
C4	Deeper Sleep

NOTE: AutoHALT or MWAIT/C1

Figure 1. Package-Level Low-Power States

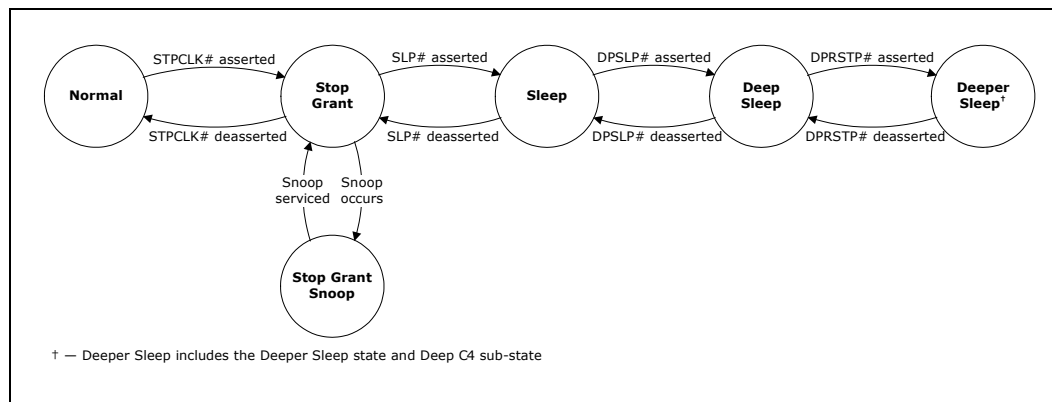
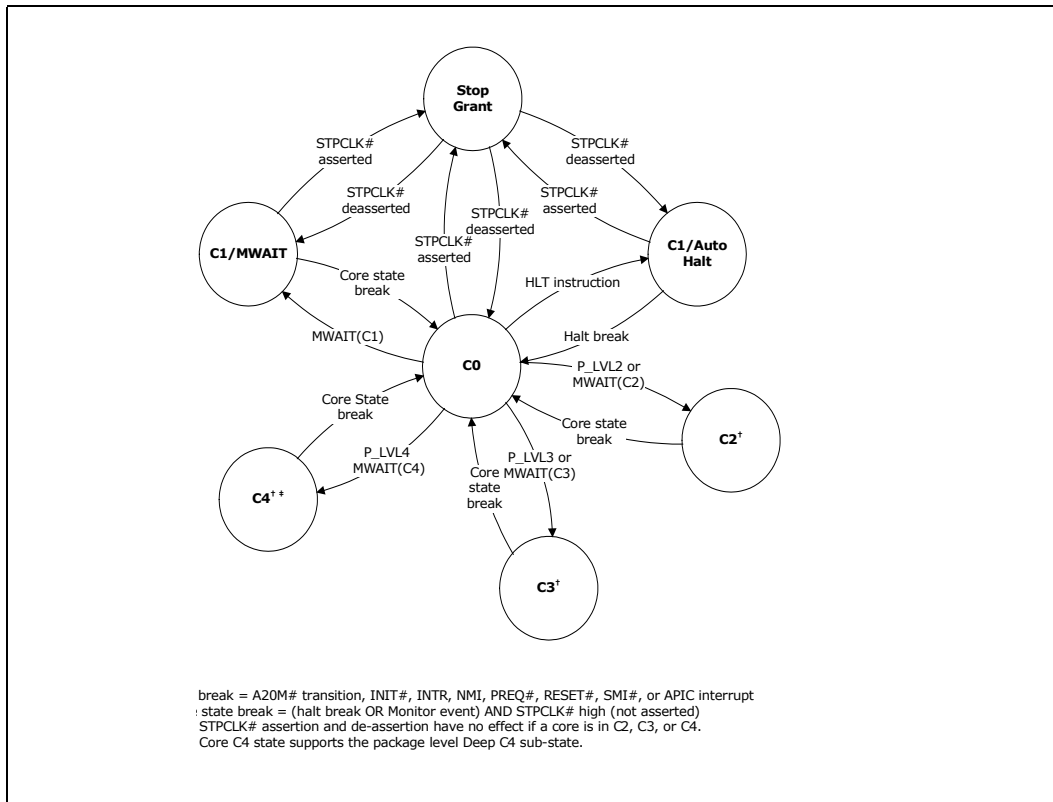

Figure 2. Core Low-Power States



2.1.1 Core Low-Power States

2.1.1.1 C0 State

This is the normal operating state of the processor.

2.1.1.2 C1/AutoHALT Powerdown State

C1/AutoHALT is a low-power state entered when the processor core executes the HALT instruction. The processor core transitions to the C0 state upon the occurrence of SMI#, INIT#, LINT[1:0] (NMI, INTR), or FSB interrupt message. RESET# causes the processor to immediately initialize itself.

A System Management Interrupt (SMI) A System Management Interrupt (SMI) handler returns execution to either Normal state or the C1/AutoHALT Powerdown state. See the *Intel® 64 and IA-32 Intel® Architecture Software Developer's Manual, Volume 3A/3B: System Programmer's Guide* for more information.

The system can generate a STPCLK# while the processor is in the C1/AutoHALT Powerdown state. When the system deasserts the STPCLK# interrupt, the processor returns execution to the HALT state.

The processor in C1/AutoHALT powerdown state process only the bus snoops. The processor enters a snooperable sub-state (not shown in Figure 2) to process the snoop and then return to the C1/AutoHALT Powerdown state.



2.1.1.3 C1/MWAIT Powerdown State

C1/MWAIT is a low-power state entered when the processor core executes the MWAIT instruction. Processor behavior in the C1/MWAIT state is identical to the C1/AutoHALT state except that there is an additional event that can cause the processor core to return to the C0 state: the Monitor event. See the *Intel® 64 and IA-32 Intel® Architecture Software Developer's Manual, Volume 2A/2B: Instruction Set Reference* for more information.

2.1.1.4 Core C2 State

The core of the processor can enter the C2 state by initiating a P_LVL2 I/O read to the P_BLK or an MWAIT(C2) instruction, but the processor does not issue a Stop Grant Acknowledge special bus cycle unless the STPCLK# pin is also asserted.

The processor in C2 state processes only the bus snoops. The processor enters a snooperable sub-state (not shown in [Figure 2](#)) to process the snoop and then return to the C2 state.

2.1.1.5 Core C3 State

Core C3 state is a very low-power state the processor core can enter while maintaining context. The core of the processor can enter the C3 state by initiating a P_LVL3 I/O read to the P_BLK or an MWAIT(C3) instruction. Before entering the C3 state, the processor core flushes the contents of its L1 cache into the processor's L2 cache. Except for the caches, the processor core maintains all its architectural state in the C3 state. The Monitor remains armed if it is configured. All of the clocks in the processor core are stopped in the C3 state.

Because the core's caches are flushed, the processor keeps the core in the C3 state when the processor detects a snoop on the FSB. The processor core transitions to the C0 state upon the occurrence of a Monitor event, SMI#, INIT#, LINT[1:0] (NMI, INTR), or FSB interrupt message. RESET# causes the processor core to immediately initialize itself.

2.1.1.6 Core C4 State

Individual cores of the dual-core processor that have C4 can enter the C4 state by initiating a P_LVL4 I/O read to the P_BLK or an MWAIT(C4) instruction. The processor core behavior in the C4 state is nearly identical to the behavior in the C3 state. The only difference is that if both processor cores are in C4, the central power management logic will request that the entire processor enter the Deeper Sleep package low-power state (see [Section 2.1.2.6](#))

2.1.2 Package Low-Power States

Package level low-power states are applicable to the processor.

2.1.2.1 Normal State

This is the normal operating state for the processor. The processor enters the Normal state when the core is in the C0, C1/AutoHALT, or C1/MWAIT state.

2.1.2.2 Stop-Grant State

When the STPCLK# pin is asserted the core of the processor enters the Stop-Grant state within 20 bus clocks after the response phase of the processor-issued Stop Grant Acknowledge special bus cycle. When the STPCLK# pin is deasserted the core returns to the previous core low-power state.

Since the AGTL+ signal pins receive power from the FSB, these pins should not be driven (allowing the level to return to V_{CCP}) for minimum power drawn by the termination resistors in this state. In addition, all other input pins on the FSB should be driven to the inactive state.

RESET# causes the processor to immediately initialize itself, but the processor stays in Stop-Grant state. When RESET# is asserted by the system the STPCLK#, SLP#, and DPSP# pins must be deasserted more than 480 μ s prior to RESET# deassertion (AC Specification T45). When re-entering the Stop-Grant state from the Sleep state, STPCLK# should be deasserted ten or more bus clocks after the deassertion of SLP# (AC Specification T75).

While in the Stop-Grant state, the processor services snoops and latch interrupts delivered on the FSB. The processor latches SMI#, INIT# and LINT[1:0] interrupts and services only upon return to the Normal state.

The PBE# signal may be driven when the processor is in Stop-Grant state. PBE# is asserted if there is any pending interrupt or monitor event latched within the processor. Pending interrupts that are blocked by the EFLAGS.IF bit being clear still cause assertion of PBE#. Assertion of PBE# indicates to system logic that the processor should return to the Normal state.

A transition to the Stop Grant Snoop state occurs when the processor detects a snoop on the FSB (see [Section 2.1.2.3](#)). A transition to the Sleep state (see [Section 2.1.2.4](#)) occurs with the assertion of the SLP# signal.

2.1.2.3 Stop Grant Snoop State

The processor responds to snoop or interrupt transactions on the FSB while in Stop-Grant state by entering the Stop-Grant Snoop state. The processor stays in this state until the snoop on the FSB has been serviced (whether by the processor or another agent on the FSB) or the interrupt has been latched. The processor returns to the Stop-Grant state once the snoop has been serviced or the interrupt has been latched.

2.1.2.4 Sleep State

The Sleep state is a low-power state in which the processor maintains its context, maintains the phase-locked loop (PLL), and stops all internal clocks. The Sleep state is entered through assertion of the SLP# signal while in the Stop-Grant state. The SLP# pin should only be asserted when the processor is in the Stop-Grant state. SLP# assertions while the processor is not in the Stop-Grant state is out of specification and may result in unapproved operation.

In the Sleep state, the processor is incapable of responding to snoop transactions or latching interrupt signals. No transitions or assertions of signals (with the exception of SLP#, DPSP# or RESET#) are allowed on the FSB while the processor is in Sleep state. Snoop events that occur while in Sleep state or during a transition into or out of Sleep state causes unpredictable behavior. Any transition on an input signal before the processor has returned to the Stop-Grant state results in unpredictable behavior.

If RESET# is driven active while the processor is in the Sleep state, and held active as specified in the RESET# pin specification, then the processor resets itself, ignoring the transition through Stop-Grant state. If RESET# is driven active while the processor is in the Sleep state, the SLP# and STPCLK# signals should be deasserted immediately after RESET# is asserted to ensure the processor correctly executes the Reset sequence.

While in the Sleep state, the processor is capable of entering an even lower power state, the Deep Sleep state, by asserting the DPSP# pin. (See [Section 2.1.2.5](#).) While the processor is in the Sleep state, the SLP# pin must be deasserted if another asynchronous FSB event needs to occur.



2.1.2.5 Deep Sleep State

Deep Sleep state is a very low-power state the processor can enter while maintaining context. Deep Sleep state is entered by asserting the DPSLP# pin while in the Sleep state. BCLK may be stopped during the Deep Sleep state for additional platform level power savings. BCLK stop/restart timings on appropriate chipset based platforms with the CK505 clock chip are as follows:

- Deep Sleep entry: the system clock chip may stop/tristate BCLK within 2 BCLKs of DPSLP# assertion. It is permissible to leave BCLK running during Deep Sleep.
- Deep Sleep exit: the system clock chip must drive BCLK to differential DC levels within 2-3 ns of DPSLP# deassertion and start toggling BCLK within 10 BCLK periods.

To re-enter the Sleep state, the DPSLP# pin must be deasserted. BCLK can be re-started after DPSLP# deassertion as described above. A period of 15 microseconds (to allow for PLL stabilization) must occur before the processor can be considered to be in the Sleep state. Once in the Sleep state, the SLP# pin must be deasserted to re-enter the Stop-Grant state.

While in Deep Sleep state, the processor is incapable of responding to snoop transactions or latching interrupt signals. No transitions of signals are allowed on the FSB while the processor is in Deep Sleep state. Any transition on an input signal before the processor has returned to Stop-Grant state results in unpredictable behavior.

2.1.2.6 Deeper Sleep State

The Deeper Sleep state is similar to the Deep Sleep state but further reduces core voltage levels. One of the potential lower core voltage levels is achieved by entering the base Deeper Sleep state. The Deeper Sleep state is entered through assertion of the DPRSTP# pin while in the Deep Sleep state. The following lower core voltage level is achieved by entering the Intel Enhanced Deeper Sleep state which is a sub-state of Deeper Sleep state. Intel Enhanced Deeper Sleep state is entered through assertion of the DPRSTP# pin while in the Deep Sleep only when the L2 cache has been completely shut down.

Exit from Deeper Sleep is initiated by DPRSTP# deassertion when either core requests a core state other than C4 or either core requests a processor performance state other than the lowest operating point.

2.2 Enhanced Intel SpeedStep® Technology

Some processors feature Enhanced Intel SpeedStep Technology. See each processor's DCL to see if it supports Enhanced Intel SpeedStep Technology. Following are the key features of Enhanced Intel SpeedStep Technology:

- Multiple voltage and frequency operating points provide optimal performance at the lowest power.
- Voltage and frequency selection is software-controlled by writing to processor MSRs:
 - If the target frequency is higher than the current frequency, V_{CC} is ramped up in steps by placing new values on the VID pins, and the PLL then locks to the new frequency.
 - If the target frequency is lower than the current frequency, the PLL locks to the new frequency and the V_{CC} is changed through the VID pin mechanism.
 - Software transitions are accepted at any time. If a previous transition is in progress, the new transition is deferred until the previous transition completes.



- The processor controls voltage ramp rates internally to ensure glitch-free transitions.
- Low transition latency and large number of transitions possible per second:
 - Processor core (including L2 cache) is unavailable for up to 10 μ s during the frequency transition.
 - The bus protocol (BNR# mechanism) is used to block snooping.
- Improved Intel® Thermal Monitor mode:
 - When the on-die thermal sensor indicates that the die temperature is too high the processor can automatically perform a transition to a lower frequency and voltage specified in a software-programmable MSR.
 - The processor waits for a fixed time period. If the die temperature is down to acceptable levels, an up-transition to the previous frequency and voltage point occurs.
 - An interrupt is generated for the up and down Intel Thermal Monitor transitions enabling better system-level thermal management.
- Enhanced thermal management features:
 - Digital Thermal Sensor and Out of Specification detection.
 - Intel Thermal Monitor 1 (TM1) in addition to Intel Thermal Monitor 2 (TM2) in case of unsuccessful TM2 transition.
 - Dual core thermal management synchronization.

Each core in the dual-core processor implements an independent MSR for controlling Enhanced Intel SpeedStep Technology, but both cores must operate at the same frequency and voltage. The processor has performance state coordination logic to resolve frequency and voltage requests from the two cores into a single frequency and voltage request for the package as a whole. If both cores request the same frequency and voltage, then the processor will transition to the requested common frequency and voltage. If the two cores have different frequency and voltage requests, then the processor will take the highest of the two frequencies and voltages as the resolved request and transition to that frequency and voltage.

Caution: **Enhanced Intel SpeedStep Technology transitions are multistep processes that require clocked control.** These transitions cannot occur when the processor is in the Sleep or Deep Sleep package low-power states since processor clocks are not active in these states.

2.3 Low-Power FSB Features

The processor incorporates FSB low-power enhancements:

- Dynamic On Die Termination disabling
- Low V_{CCP} (I/O termination voltage)

The On Die Termination on the processor FSB buffers is disabled when the signals are driven low, resulting in power savings. The low I/O termination voltage is on a dedicated voltage plane independent of the core voltage, enabling low I/O switching power at all times.

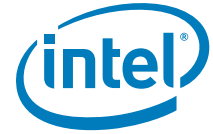

2.4 Processor Power Status Indicator (PSI#) Signal

The PSI# signal is asserted when the processor is in a reduced power consumption state. PSI# can be used to improve light load efficiency of the voltage regulator, resulting in platform power savings and extended battery life. The algorithm that the processor uses for determining when to assert PSI# is different from the algorithm used in previous processors.





3 Electrical Specifications

3.1 Power and Ground Pins

For clean, on-chip power distribution, the processor has a large number of V_{CC} (power) and V_{SS} (ground) inputs. All power pins must be connected to V_{CC} power planes while all V_{SS} pins must be connected to system ground planes. Use of multiple power and ground planes is recommended to reduce I^2R drop. The processor V_{CC} pins must be supplied the voltage determined by the VID (Voltage ID) pins.

3.2 FSB Clock (BCLK[1:0]) and Processor Clocking

BCLK[1:0] directly controls the FSB interface speed as well as the core frequency of the processor. As in previous generation processors, the processor core frequency is a multiple of the BCLK[1:0] frequency. The processor uses a differential clocking implementation.

3.3 Voltage Identification

The processor uses seven voltage identification pins, VID[6:0], to support automatic selection of power supply voltages. The VID pins for processor are CMOS outputs driven by the processor VID circuitry. Table 2 specifies the voltage level corresponding to the state of VID[6:0]. A 1 refers to a high-voltage level and a 0 refers to low-voltage level.

Table 2. Voltage Identification Definition (Sheet 1 of 4)

VID6	VID5	VID4	VID3	VID2	VID1	VID0	V _{CC} (V)
0	0	0	0	0	0	0	1.5000
0	0	0	0	0	0	1	1.4875
0	0	0	0	0	1	0	1.4750
0	0	0	0	0	1	1	1.4625
0	0	0	0	1	0	0	1.4500
0	0	0	0	1	0	1	1.4375
0	0	0	0	1	1	0	1.4250
0	0	0	0	1	1	1	1.4125
0	0	0	1	0	0	0	1.4000
0	0	0	1	0	0	1	1.3875
0	0	0	1	0	1	0	1.3750
0	0	0	1	0	1	1	1.3625
0	0	0	1	1	0	0	1.3500
0	0	0	1	1	0	1	1.3375
0	0	0	1	1	1	0	1.3250
0	0	0	1	1	1	1	1.3125
0	0	1	0	0	0	0	1.3000
0	0	1	0	0	0	1	1.2875
0	0	1	0	0	1	0	1.2750
0	0	1	0	0	1	1	1.2625
0	0	1	0	1	0	0	1.2500
0	0	1	0	1	0	1	1.2375



Table 2. Voltage Identification Definition (Sheet 2 of 4)

VID6	VID5	VID4	VID3	VID2	VID1	VID0	V _{CC} (V)
0	0	1	0	1	1	0	1.2250
0	0	1	0	1	1	1	1.2125
0	0	1	1	0	0	0	1.2000
0	0	1	1	0	0	1	1.1875
0	0	1	1	0	1	0	1.1750
0	0	1	1	0	1	1	1.1625
0	0	1	1	1	0	0	1.1500
0	0	1	1	1	0	1	1.1375
0	0	1	1	1	1	0	1.1250
0	0	1	1	1	1	1	1.1125
0	1	0	0	0	0	0	1.1000
0	1	0	0	0	0	1	1.0875
0	1	0	0	0	1	0	1.0750
0	1	0	0	0	1	1	1.0625
0	1	0	0	1	0	0	1.0500
0	1	0	0	1	0	1	1.0375
0	1	0	0	1	1	0	1.0250
0	1	0	0	1	1	1	1.0125
0	1	0	1	0	0	0	1.0000
0	1	0	1	0	0	1	0.9875
0	1	0	1	0	1	0	0.9750
0	1	0	1	0	1	1	0.9625
0	1	0	1	1	0	0	0.9500
0	1	0	1	1	0	1	0.9375
0	1	0	1	1	1	0	0.9250
0	1	0	1	1	1	1	0.9125
0	1	1	0	0	0	0	0.9000
0	1	1	0	0	0	1	0.8875
0	1	1	0	0	1	0	0.8750
0	1	1	0	0	1	1	0.8625
0	1	1	0	1	0	0	0.8500
0	1	1	0	1	0	1	0.8375
0	1	1	0	1	1	0	0.8250
0	1	1	0	1	1	1	0.8125
0	1	1	1	0	0	0	0.8000
0	1	1	1	0	0	1	0.7875
0	1	1	1	0	1	0	0.7750
0	1	1	1	0	1	1	0.7625
0	1	1	1	1	0	0	0.7500
0	1	1	1	1	0	1	0.7375
0	1	1	1	1	1	0	0.7250
0	1	1	1	1	1	1	0.7125
1	0	0	0	0	0	0	0.7000
1	0	0	0	0	0	1	0.6875
1	0	0	0	0	1	0	0.6750
1	0	0	0	0	1	1	0.6625
1	0	0	0	1	0	0	0.6500

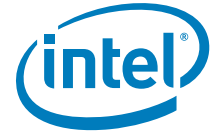

Table 2. Voltage Identification Definition (Sheet 3 of 4)

VID6	VID5	VID4	VID3	VID2	VID1	VID0	V _{CC} (V)
1	0	0	0	1	0	1	0.6375
1	0	0	0	1	1	0	0.6250
1	0	0	0	1	1	1	0.6125
1	0	0	1	0	0	0	0.6000
1	0	0	1	0	0	1	0.5875
1	0	0	1	0	1	0	0.5750
1	0	0	1	0	1	1	0.5625
1	0	0	1	1	0	0	0.5500
1	0	0	1	1	0	1	0.5375
1	0	0	1	1	1	0	0.5250
1	0	0	1	1	1	1	0.5125
1	0	1	0	0	0	0	0.5000
1	0	1	0	0	0	1	0.4875
1	0	1	0	0	1	0	0.4750
1	0	1	0	0	1	1	0.4625
1	0	1	0	1	0	0	0.4500
1	0	1	0	1	0	1	0.4375
1	0	1	0	1	1	0	0.4250
1	0	1	0	1	1	1	0.4125
1	0	1	1	0	0	0	0.4000
1	0	1	1	0	0	1	0.3875
1	0	1	1	0	1	0	0.3750
1	0	1	1	0	1	1	0.3625
1	0	1	1	1	0	0	0.3500
1	0	1	1	1	0	1	0.3375
1	0	1	1	1	1	0	0.3250
1	0	1	1	1	1	1	0.3125
1	1	0	0	0	0	0	0.3000
1	1	0	0	0	0	1	0.2875
1	1	0	0	0	1	0	0.2750
1	1	0	0	0	1	1	0.2625
1	1	0	0	1	0	0	0.2500
1	1	0	0	1	0	1	0.2375
1	1	0	0	1	1	0	0.2250
1	1	0	0	1	1	1	0.2125
1	1	0	1	0	0	0	0.2000
1	1	0	1	0	0	1	0.1875
1	1	0	1	0	1	0	0.1750
1	1	0	1	0	1	1	0.1625
1	1	0	1	1	0	0	0.1500
1	1	0	1	1	0	1	0.1375
1	1	0	1	1	1	0	0.1250
1	1	0	1	1	1	1	0.1125
1	1	1	0	0	0	0	0.1000
1	1	1	0	0	0	1	0.0875
1	1	1	0	0	1	0	0.0750
1	1	1	0	0	1	1	0.0625

Table 2. Voltage Identification Definition (Sheet 4 of 4)

VID6	VID5	VID4	VID3	VID2	VID1	VID0	V _{CC} (V)
1	1	1	0	1	0	0	0.0500
1	1	1	0	1	0	1	0.0375
1	1	1	0	1	1	0	0.0250
1	1	1	0	1	1	1	0.0125
1	1	1	1	0	0	0	0.0000
1	1	1	1	0	0	1	0.0000
1	1	1	1	0	1	0	0.0000
1	1	1	1	0	1	1	0.0000
1	1	1	1	1	0	0	0.0000
1	1	1	1	1	0	1	0.0000
1	1	1	1	1	1	0	0.0000
1	1	1	1	1	1	1	0.0000

3.4 Catastrophic Thermal Protection

The processor supports the THERMTRIP# signal for catastrophic thermal protection. An external thermal sensor should also be used to protect the processor and the system against excessive temperatures. Even with the activation of THERMTRIP#, which halts all processor internal clocks and activity, leakage current can be high enough that the processor cannot be protected in all conditions without power removal to the processor. If the external thermal sensor detects a catastrophic processor temperature of 125 °C (maximum), or if the THERMTRIP# signal is asserted, the V_{CC} supply to the processor must be turned off within 500 ms to prevent permanent silicon damage due to thermal runaway of the processor. THERMTRIP# functionality is not guaranteed if the PWRGOOD signal is not asserted.

3.5 Reserved and Unused Pins

All RESERVED (RSVD) pins must remain unconnected. Connection of these pins to V_{CC}, V_{SS}, or to any other signal (including each other) may result in component malfunction or incompatibility with future processors. See Section 4.2 for a pin listing of the processor and the location of all RSVD pins.

For reliable operation, always connect unused inputs or bidirectional signals to an appropriate signal level. Unused active low AGTL+ inputs may be left as no connects if AGTL+ termination is provided on the processor silicon. Unused active high inputs should be connected through a resistor to ground (V_{SS}). Unused outputs can be left unconnected.

The TEST1 and TEST2 pins must have a stuffing option of separate pull-down resistors to V_{SS}.

For the purpose of testability, route the TEST3 and TEST5 signals through a ground-referenced Zo = 55-Ω trace that ends in a via that is near a GND via and is accessible through an oscilloscope connection.



3.6 FSB Frequency Select Signals (BSEL[2:0])

The BSEL[2:0] signals are used to select the frequency of the processor input clock (BCLK[1:0]). These signals should be connected to the clock chip and the appropriate chipset on the platform. The BSEL encoding for BCLK[1:0] is shown in [Table 3](#).

Table 3. BSEL[2:0] Encoding for BCLK Frequency

BSEL[2]	BSEL[1]	BSEL[0]	BCLK Frequency
L	L	L	RESERVED
L	L	H	133 MHz
L	H	H	RESERVED
L	H	L	200 MHz
H	H	L	RESERVED
H	H	H	RESERVED
H	L	H	RESERVED
H	L	L	RESERVED

3.7 FSB Signal Groups

The FSB signals have been combined into groups by buffer type in the following sections. AGTL+ input signals have differential input buffers, which use GTLREF as a reference level. In this document, the term "AGTL+ Input" refers to the AGTL+ input group as well as the AGTL+ I/O group when receiving. Similarly, "AGTL+ Output" refers to the AGTL+ output group as well as the AGTL+ I/O group when driving.

With the implementation of a source synchronous data bus, two sets of timing parameters need to be specified. One set is for common clock signals, which are dependent upon the rising edge of BCLK0 (ADS#, HIT#, HITM#, etc.) and the second set is for the source synchronous signals, which are relative to their respective strobe lines (data and address) as well as the rising edge of BCLK0. Asynchronous signals are still present (A20M#, IGNNE#, etc.) and can become active at any time during the clock cycle. [Table 4](#) identifies which signals are common clock, source synchronous, and asynchronous.

Table 4. FSB Pin Groups

Signal Group	Type	Signals ¹														
AGTL+ Common Clock Input	Synchronous to BCLK[1:0]	BPRI#, DEFER#, PREQ# ⁵ , RESET#, RS[2:0]#, TRDY#														
AGTL+ Common Clock I/O	Synchronous to BCLK[1:0]	ADS#, BNR#, BPM[3:0]# ³ , BR0#, DBSY#, DRDY#, HIT#, HITM#, LOCK#, PRDY# ³ , DPWR#														
AGTL+ Source Synchronous I/O	Synchronous to assoc. strobe	<table border="1"> <thead> <tr> <th>Signals</th> <th>Associated Strobe</th> </tr> </thead> <tbody> <tr> <td>REQ[4:0]#, A[16:3]#</td> <td>ADSTB[0]#</td> </tr> <tr> <td>A[35:17]#</td> <td>ADSTB[1]#</td> </tr> <tr> <td>D[15:0]#, DINV0#</td> <td>DSTBP0#, DSTBN0#</td> </tr> <tr> <td>D[31:16]#, DINV1#</td> <td>DSTBP1#, DSTBN1#</td> </tr> <tr> <td>D[47:32]#, DINV2#</td> <td>DSTBP2#, DSTBN2#</td> </tr> <tr> <td>D[63:48]#, DINV3#</td> <td>DSTBP3#, DSTBN3#</td> </tr> </tbody> </table>	Signals	Associated Strobe	REQ[4:0]#, A[16:3]#	ADSTB[0]#	A[35:17]#	ADSTB[1]#	D[15:0]#, DINV0#	DSTBP0#, DSTBN0#	D[31:16]#, DINV1#	DSTBP1#, DSTBN1#	D[47:32]#, DINV2#	DSTBP2#, DSTBN2#	D[63:48]#, DINV3#	DSTBP3#, DSTBN3#
		Signals	Associated Strobe													
		REQ[4:0]#, A[16:3]#	ADSTB[0]#													
		A[35:17]#	ADSTB[1]#													
		D[15:0]#, DINV0#	DSTBP0#, DSTBN0#													
		D[31:16]#, DINV1#	DSTBP1#, DSTBN1#													
		D[47:32]#, DINV2#	DSTBP2#, DSTBN2#													
D[63:48]#, DINV3#	DSTBP3#, DSTBN3#															
AGTL+ Strobes	Synchronous to BCLK[1:0]	ADSTB[1:0]#, DSTBP[3:0]#, DSTBN[3:0]#														
CMOS Input	Asynchronous	A20M#, DPRSTP#, DPSLP#, IGNNE#, INIT#, LINT0/INTR, LINT1/NMI, PWRGOOD, SMI#, SLP#, STPCLK#														
Open Drain Output	Asynchronous	FERR#, IERR#, THERMTRIP#														
Open Drain I/O	Asynchronous	PROCHOT# ⁴														
CMOS Output	Asynchronous	PSI#, VID[6:0], BSEL[2:0]														
CMOS Input	Synchronous to TCK	TCK, TDI, TMS, TRST#														
Open Drain Output	Synchronous to TCK	TDO														
FSB Clock	Clock	BCLK[1:0]														
Power/Other		COMP[3:0], DBR# ² , GTLREF, RSVD, TEST2, TEST1, THERMDA, THERMDC, V _{CC} , V _{CCA} , V _{CCP} , V _{CC_SENSE} , V _{SS} , V _{SS_SENSE}														

NOTES:

1. Refer to Chapter 4 for signal descriptions and termination requirements.
2. In processor systems where there is no debug port implemented on the system board, these signals are used to support a debug port interposer. In systems with the debug port implemented on the system board, these signals are no connects.
3. BPM[2:1]# and PRDY# are AGTL+ output only signals.
4. PROCHOT# signal type is open drain output and CMOS input.
5. On die termination differs from other AGTL+ signals.



3.8 CMOS Signals

CMOS input signals are shown in Table 4. Legacy output FERR#, IERR# and other non-AGTL+ signals (THERMTRIP# and PROCHOT#) utilize Open Drain output buffers. These signals do not have setup or hold time specifications in relation to BCLK[1:0]. However, all of the CMOS signals are required to be asserted for more than four BCLKs in order for the processor to recognize them. See Section 3.10 for the DC specifications for the CMOS signal groups.

3.9 Maximum Ratings

Table 5 specifies absolute maximum and minimum ratings. If the processor stays within functional operation limits, functionality and long-term reliability can be expected.

Caution: At conditions outside functional operation condition limits, but within absolute maximum and minimum ratings, neither functionality nor long term reliability can be expected. At conditions exceeding absolute maximum and minimum ratings, neither functionality nor long term reliability can be expected.

Caution: Precautions should always be taken to avoid high-static voltages or electric fields.

Table 5. Processor Absolute Maximum Ratings

Symbol	Parameter	Min	Max	Unit	Notes ¹
T _{STORAGE}	Processor storage temperature	-40	85	°C	2, 3, 4
V _{CC}	Any processor supply voltage with respect to V _{SS}	-0.3	1.55	V	
V _{InAGTL+}	AGTL+ buffer DC input voltage with respect to V _{SS}	-0.1	1.55	V	
V _{InAsynch_CMOS}	CMOS buffer DC input voltage with respect to V _{SS}	-0.1	1.55	V	

NOTES:

1. For functional operation, all processor electrical, signal quality, mechanical and thermal specifications must be satisfied.
2. Storage temperature is applicable to storage conditions only. In this scenario, the processor must not receive a clock, and no lands can be connected to a voltage bias. Storage within these limits does not affect the long term reliability of the device. For functional operation, please refer to the processor case temperature specifications.
3. This rating applies to the processor and does not include any tray or packaging.
4. Failure to adhere to this specification can affect the long-term reliability of the processor.



3.10 Processor DC Specifications

The processor DC specifications in this section are defined at the processor core (pads) unless noted otherwise. See [Table 4](#) for the pin signal definitions and signal pin assignments.

[Table 7](#) through [Table 10](#) list the DC specifications for the processor and are valid only while meeting specifications for junction temperature, clock frequency, and input voltages. The Highest Frequency Mode (HFM) and Super Low Frequency Mode (SuperLFM) refer to the highest and lowest core operating frequencies supported on the processor. Active mode load line specifications apply in all states except in the Deep Sleep and Deeper Sleep states. $V_{CC,BOOT}$ is the default voltage driven by the voltage regulator at power up in order to set the VID values. Unless specified otherwise, all specifications for the processor are at $T_{junction} = 100\text{ }^{\circ}\text{C}$. Care should be taken to read all notes associated with each parameter.

**Table 6. DC Voltage and Current Specifications for the T3x00 Celeron Processors**

Symbol	Parameter			Min	Typ	Max	Unit	Notes
V _{CC}	V _{CC} of the Processor Core			0.8		1.25	V	1, 2
V _{CC,BOOT}	Default V _{CC} Voltage for Initial Power Up				1.20		V	2, 8
V _{CCP}	AGTL+ Termination Voltage			1.00	1.05	1.10	V	
V _{CCA}	PLL Supply Voltage			1.425	1.5	1.575	V	
I _{CCDES}	I _{CC} for processors Recommended Design Targets:					47	A	5
I _{CC}	I _{CC} for processors						A	
	Processor Number	Frequency	Die Variant					
	T3000	1.8 GHz	1 MB			47	A	3, 4
	T3100	1.9 GHz	1 MB			47	A	3, 4
I _{AH} , I _{SGNT}	I _{CC} Auto-Halt & Stop-Grant					25.4	A	3, 4
I _{SLP}	I _{CC} Sleep					24.7	A	3, 4
I _{DSP}	I _{CC} Deep Sleep					22.9	A	3, 4
dI _{CC} /DT	V _{CC} Power Supply Current Slew Rate at CPU Package Pin					600	A/μs	6, 7
I _{CCA}	I _{CC} for V _{CCA} Supply					130	mA	
I _{CCP}	I _{CC} for V _{CCP} Supply before V _{CC} Stable					4.5	A	9
	I _{CC} for V _{CCP} Supply after V _{CC} Stable					2.5	A	10

NOTES:

- Each processor is programmed with a maximum valid voltage identification value (VID), which is set at manufacturing and cannot be altered. Individual maximum VID values are calibrated during manufacturing in such a way that two processors at the same frequency may have different settings within the VID range. Note that this differs from the VID employed by the processor during a power management event (Intel Thermal Monitor 2, or Extended Halt State).
- The voltage specifications are assumed to be measured across V_{CC_SENSE} and V_{SS_SENSE} pins at socket with a 100-MHz bandwidth oscilloscope, 1.5-pF maximum probe capacitance, and 1-mΩ minimum impedance. The maximum length of ground wire on the probe should be less than 5 mm. Ensure external noise from the system is not coupled in the scope probe.
- Specified at 105 °C T_j.
- Specified at the nominal V_{CC}.
- 800-MHz FSB supported
- Instantaneous current I_{CC_CORE_INST} of 55 A has to be sustained for short time (t_{INST}) of 10 μs. Average current is less than maximum specified I_{CCDES}. VR OCP threshold should be high enough to support current levels described herein.
- Measured at the bulk capacitors on the motherboard.
- Based on simulations and averaged over the duration of any change in current. Specified by design/characterization at nominal V_{CC}. Not 100% tested.
- This is a power-up peak current specification, which is applicable when V_{CCP} is high and V_{CC_CORE} is low.
- This is a steady-state I_{CC} current specification, which is applicable when both V_{CCP} and V_{CC_CORE} are high.

1-MB L2 cache.



Table 7. DC Voltage and Current Specifications for the T1x00 Celeron Mobile Processors

Symbol	Parameter			Min	Typ	Max	Unit	Notes
V _{CC}	V _{CC} of the Processor Core			0.95	1.15	1.30	V	1, 2
V _{CC,BOOT}	Default V _{CC} Voltage for Initial Power Up				1.20		V	2, 8
V _{CCP}	AGTL+ Termination Voltage			1.00	1.05	1.10	V	
V _{CCA}	PLL Supply Voltage			1.425	1.5	1.575	V	
I _{CCDES}	I _{CC} for processors Recommended Design Targets:					36	A	5
I _{CC}	I _{CC} for processors						A	
	Processor Number	Frequency	Die Variant					
	T1600	1.66 GHz	1 MB			41	A	3, 4
	T1700	1.83 GHz	1 MB			41	A	3, 4
I _{AH} , I _{SGNT}	I _{CC} Auto-Halt & Stop-Grant					21	A	3, 4
I _{SLP}	I _{CC} Sleep					20.5	A	3, 4
I _{DSP}	I _{CC} Deep Sleep					18.6	A	3, 4
dI _{CC} /DT	V _{CC} Power Supply Current Slew Rate at CPU Package Pin					600	A/μs	6, 7
I _{CCA}	I _{CC} for V _{CCA} Supply					130	mA	
I _{CCP}	I _{CC} for V _{CCP} Supply before V _{CC} Stable					4.5	A	9
	I _{CC} for V _{CCP} Supply after V _{CC} Stable					2.5	A	10

NOTES:

- Each processor is programmed with a maximum valid voltage identification value (VID), which is set at manufacturing and cannot be altered. Individual maximum VID values are calibrated during manufacturing in such a way that two processors at the same frequency may have different settings within the VID range. Note that this differs from the VID employed by the processor during a power management event (Intel Thermal Monitor 2, or Extended Halt State).
- The voltage specifications are assumed to be measured across V_{CC_SENSE} and V_{SS_SENSE} pins at socket with a 100-MHz bandwidth oscilloscope, 1.5-pF maximum probe capacitance, and 1-mΩ minimum impedance. The maximum length of ground wire on the probe should be less than 5 mm. Ensure external noise from the system is not coupled in the scope probe.
- Specified at 100 °C T_j.
- Specified at the nominal V_{CC}.
- 667-MHz FSB supported
- Instantaneous current I_{CC_CORE_INST} of 55 A has to be sustained for short time (t_{INST}) of 10 μs. Average current is less than maximum specified I_{CCDES}. VR OCP threshold should be high enough to support current levels described herein.
- Measured at the bulk capacitors on the motherboard.
- Based on simulations and averaged over the duration of any change in current. Specified by design/ characterization at nominal V_{CC}. Not 100% tested.
- This is a power-up peak current specification, which is applicable when V_{CCP} is high and V_{CC_CORE} is low.
- This is a steady-state I_{CC} current specification, which is applicable when both V_{CCP} and V_{CC_CORE} are high.
- 512-KB L2 cache.



Table 8 lists the DC specifications for the processor and are valid only while meeting specifications for junction temperature, clock frequency, and input voltages. The Highest Frequency Mode (HFM) and Lowest Frequency Mode (LFM) refer to the highest and lowest core operating frequencies supported on the Genuine Intel Processor. Unless specified otherwise, all specifications for the processor are at T_{junction} = 100 °C. Care should be taken to read all notes associated with each parameter.

Table 8. Voltage and Current Specifications for the Ultra Low Voltage Dual-Core 1M Cache Intel Celeron SFF Genuine Intel Processor

Symbol	Parameter	Min	Typ	Max	Unit	Notes
V _{CC}	V _{CC} of the Processor Core	0.8		1.1	V	1, 2
V _{CC,BOOT}	Default V _{CC} Voltage for Initial Power Up	—	1.20	—	V	2, 8
V _{CCP}	AGTL+ Termination Voltage	1.00	1.05	1.10	V	
V _{CCA}	PLL Supply Voltage	1.425	1.5	1.575	V	
I _{CCDES}	I _{CC} for Processors Recommended Design Target	—	—	18	A	5
I _{CC}	I _{CC} for processors				A	
	Processor Number	Frequency	Die Variant			
	SU2300	1.2GHz	1MB		17.6	A, 3, 4
I _{AH} , I _{SGNT}	I _{CC} Auto-Halt & Stop-Grant	—	—	6.3	A	3, 4
I _{SLP}	I _{CC} Sleep	—	—	5.9	A	3, 4
I _{DSP}	I _{CC} Deep Sleep	—	—	5.0	A	3, 4
I _{DPRSLP}	I _{CC} Deeper Sleep	—	—	3.2	A	3, 4
dI _{CC} /dT	V _{CC} Power Supply Current Slew Rate at Processor Package Pin	—	—	600	A/μs	7
I _{CCA}	I _{CC} for V _{CCA} Supply	—	—	130	mA	
I _{CCP}	I _{CC} for V _{CCP} Supply before V _{CC} Stable	—	—	4.5	A	8
	I _{CC} for V _{CCP} Supply after V _{CC} Stable	—	—	2.5	A	9

NOTES:

- Each processor is programmed with a maximum valid voltage identification value (VID), which is set at manufacturing and can not be altered. Individual maximum VID values are calibrated during manufacturing such that two processors at the same frequency may have different settings within the VID range. Note that this differs from the VID employed by the processor during a power management event (ex: Extended Halt State).
- The voltage specifications are assumed to be measured across V_{CCSENSE} and V_{SSSENSE} pins at socket with a 100-MHz bandwidth oscilloscope, 1.5-pF maximum probe capacitance, and 1-mΩ minimum impedance. The maximum length of ground wire on the probe should be less than 5 mm. Ensure external noise from the system is not coupled in the scope probe.
- Specified at 100°C T_j.
- Specified at nominal V_{CC}.



- 5. 800-MHz FSB supported
- 6. Measured at the bulk capacitors on the motherboard.
- 7. Based on simulations and averaged over the duration of any change in current. Specified by design/characterization at nominal V_{CC} . Not 100% tested.
- 8. This is a power-up peak current specification, which is applicable when V_{CCP} is high and V_{CC} core is low.
- 9. This is a steady-state I_{cc} current specification, which is applicable when both V_{CCP} and V_{CC} core are high.
- 10. SU2300 processor operates at same core frequency in HFM and LFM.

Table 9. FSB Differential BCLK Specifications

Symbol	Parameter	Min	Typ	Max	Unit	Notes ¹
V_{CROSS}	Crossing Voltage	0.3		0.55	V	2, 7, 8
ΔV_{CROSS}	Range of Crossing Points			140	mV	2, 7, 5
V_{SWING}	Differential Output Swing	300			mV	6
I_{LI}	Input Leakage Current	-5		+5	μ A	3
Cpad	Pad Capacitance	0.95	1.2	1.45	pF	4

- 1. Unless otherwise noted, all specifications in this table apply to all processor frequencies.
- 2. Crossing Voltage is defined as absolute voltage where rising edge of BCLK0 is equal to the falling edge of BCLK1.
- 3. For V_{in} between 0 V and V_{IH} .
- 4. Cpad includes die capacitance only. No package parasitics are included.
- 5. ΔV_{CROSS} is defined as the total variation of all crossing voltages as defined in Note 2.
- 6. Measurement taken from differential waveform.
- 7. Measurement taken from single-ended waveform.
- 8. Only applies to the differential rising edge (Clock rising and Clock# falling).



Table 10. AGTL+ Signal Group DC Specifications

Symbol	Parameter	Min	Typ	Max	Unit	Notes ¹
V _{CCP}	I/O Voltage	1.00	1.05	1.10	V	
GTLREF	Reference Voltage		2/3 V _{CCP}		V	6
R _{COMP}	Compensation Resistor	27.23	27.5	27.78	Ω	10
R _{ODT}	Termination Resistor		55		Ω	11
V _{IH}	Input High Voltage	GTLREF+0.10	V _{CCP}	V _{CCP} +0.10	V	3,6
V _{IL}	Input Low Voltage	-0.10	0	GTLREF-0.10	V	2,4
V _{OH}	Output High Voltage	V _{CCP} -0.10	V _{CCP}	V _{CCP}		6
R _{TT}	Termination Resistance	50	55	61	Ω	7
R _{ON}	Buffer On Resistance	22	25	28	Ω	5
I _{LI}	Input Leakage Current			±100	μA	8
Cpad	Pad Capacitance	1.6	2.1	2.55	pF	9

NOTES:

1. Unless otherwise noted, all specifications in this table apply to all processor frequencies.
2. V_{IL} is defined as the maximum voltage level at a receiving agent that is interpreted as a logical low value.
3. V_{IH} is defined as the minimum voltage level at a receiving agent that is interpreted as a logical high value.
4. V_{IH} and V_{OH} may experience excursions above V_{CCP}. However, input signal drivers must comply with the signal quality specifications.
5. This is the pull-down driver resistance. Measured at 0.31*V_{CCP}. R_{ON} (min) = 0.4*R_{TT}, R_{ON} (typ) = 0.455*R_{TT}, R_{ON} (max) = 0.51*R_{TT}. R_{TT} typical value of 55 Ω is used for R_{ON} typ/min/max calculations.
6. GTLREF should be generated from V_{CCP} with a 1%-tolerance resistor divider. The V_{CCP} referred to in these specifications is the instantaneous V_{CCP}.
7. R_{TT} is the on-die termination resistance measured at V_{OL} of the AGTL+ output driver. Measured at 0.31*V_{CCP}. R_{TT} is connected to V_{CCP} on die.
8. Specified with on die R_{TT} and R_{ON} turned off. Vin between 0 and V_{CCP}.
9. Cpad includes die capacitance only. No package parasitics are included.
10. This is the external resistor on the comp pins.
11. On die termination resistance measured at 0.33*V_{CCP}.

Table 11. CMOS Signal Group DC Specifications

Symbol	Parameter	Min	Typ	Max	Unit	Notes ¹
V _{CCP}	I/O Voltage	1.00	1.05	1.10	V	
V _{IH}	Input High Voltage	0.7*V _{CCP}	V _{CCP}	V _{CCP} +0.1	V	2
V _{IL}	Input Low Voltage CMOS	-0.10	0.00	0.3*V _{CCP}	V	2
V _{OH}	Output High Voltage	0.9*V _{CCP}	V _{CCP}	V _{CCP} +0.1	V	2
V _{OL}	Output Low Voltage	-0.10	0	0.1*V _{CCP}	V	2
I _{OH}	Output High Current	1.5		4.1	mA	5
I _{OL}	Output Low Current	1.5		4.1	mA	4
I _{LI}	Input Leakage Current			±100	µA	6
Cpad1	Pad Capacitance	1.6	2.1	2.55	pF	7
Cpad2	Pad Capacitance for CMOS Input	0.95	1.2	1.45		3

NOTES:

1. Unless otherwise noted, all specifications in this table apply to all processor frequencies.
2. The V_{CCP} referred to in these specifications refers to instantaneous V_{CCP}.
3. Cpad2 includes die capacitance for all other CMOS input signals. No package parasitics are included.
4. Measured at 0.1*V_{CCP}.
5. Measured at 0.9*V_{CCP}.
6. For Vin between 0 V and V_{CCP}. Measured when the driver is tristated.
7. Cpad1 includes die capacitance only for DPRSTP#, DPSLP#, PWRGOOD. No package parasitics are included.

Table 12. Open Drain Signal Group DC Specifications

Symbol	Parameter	Min	Typ	Max	Unit	Notes ¹
V _{OH}	Output High Voltage	V _{CCP} -5%	V _{CCP}	V _{CCP} +5%	V	3
V _{OL}	Output Low Voltage	0		0.20	V	
I _{OL}	Output Low Current	16		50	mA	2
I _{LO}	Output Leakage Current			±200	µA	4
Cpad	Pad Capacitance	1.9	2.2	2.45	pF	5

NOTES:

1. Unless otherwise noted, all specifications in this table apply to all processor frequencies.
2. Measured at 0.2 V.
3. V_{OH} is determined by value of the external pull-up resistor to V_{CCP}.
4. For Vin between 0 V and V_{OH}.
5. Cpad includes die capacitance only. No package parasitics are included.

§



4 Package Mechanical Specifications and Pin Information

4.1 Package Mechanical Specifications

The processor is available in a 1-MB, 478-pin Micro-FCPGA package. The package mechanical dimensions, keep-out zones, processor mass specifications, and package loading specifications are shown in [Figure 3](#) through [Figure 6](#).

The SFF processor (ULV DC) is available 956-ball Micro-FCBGA packages. The package mechanical dimensions are shown in [Figure 7](#).

The maximum outgoing co-planarity is 0.2 mm (8 mils) for SFF Package

The mechanical package pressure specifications are in a direction normal to the surface of the processor. This requirement is to protect the processor die from fracture risk due to uneven die pressure distribution under tilt, stack-up tolerances and other similar conditions. These specifications assume that a mechanical attach is designed specifically to load one type of processor.

Moreover, the processor package substrate should not be used as a mechanical reference or load-bearing surface for the thermal or mechanical solution. Please refer to the *Santa Rosa Platform Mechanical Design Guide* for more details.

Note: For M-step based processors refer to the 2-MB package drawings.

Figure 3. 4-MB and Fused 2-MB Micro-FCPGA Processor Package Drawing (Sheet 1 of 2)

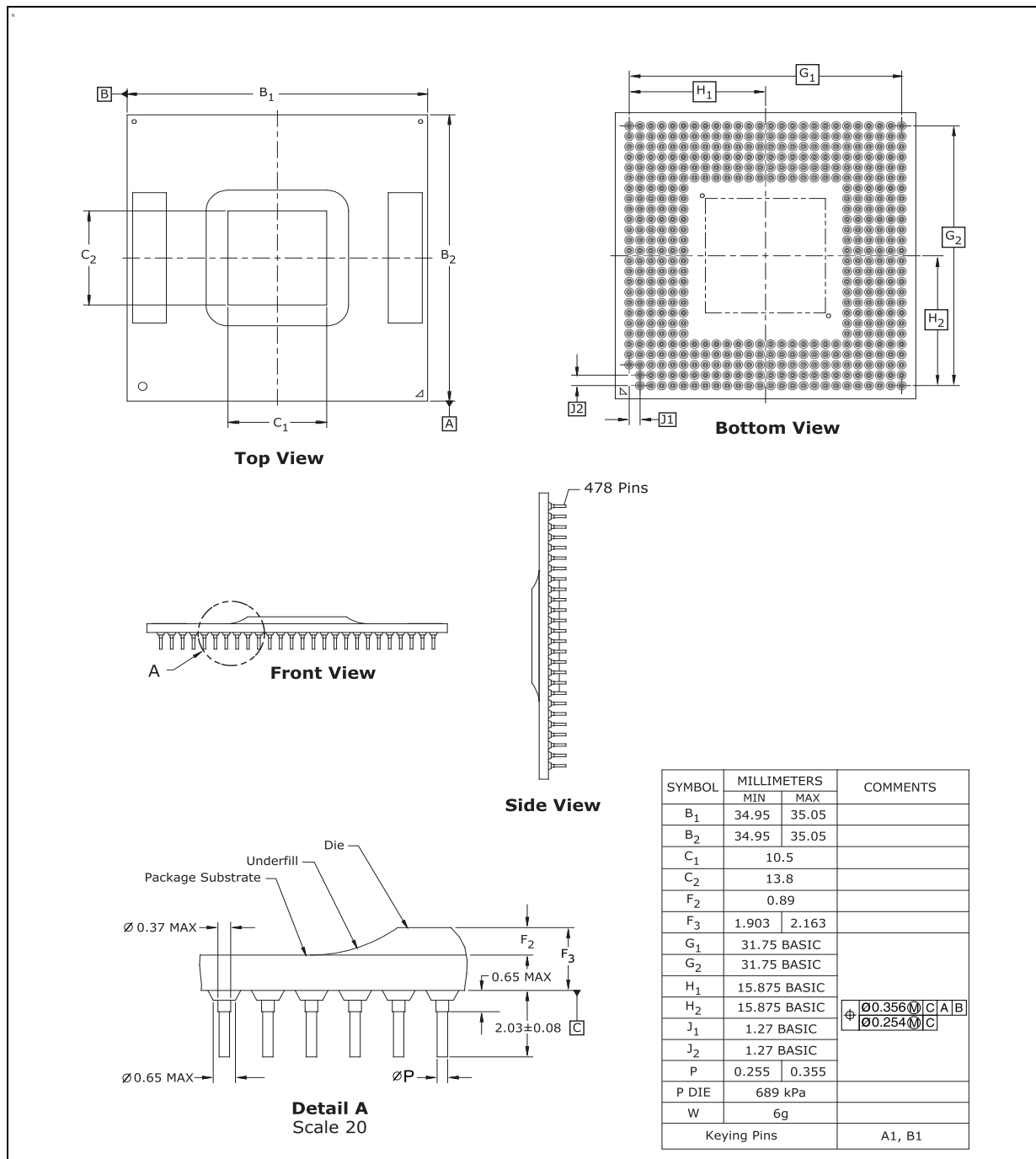

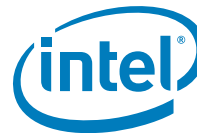

Figure 4. 4-MB and Fused 2-MB Micro-FCPGA Processor Package Drawing (Sheet 2 of 2)

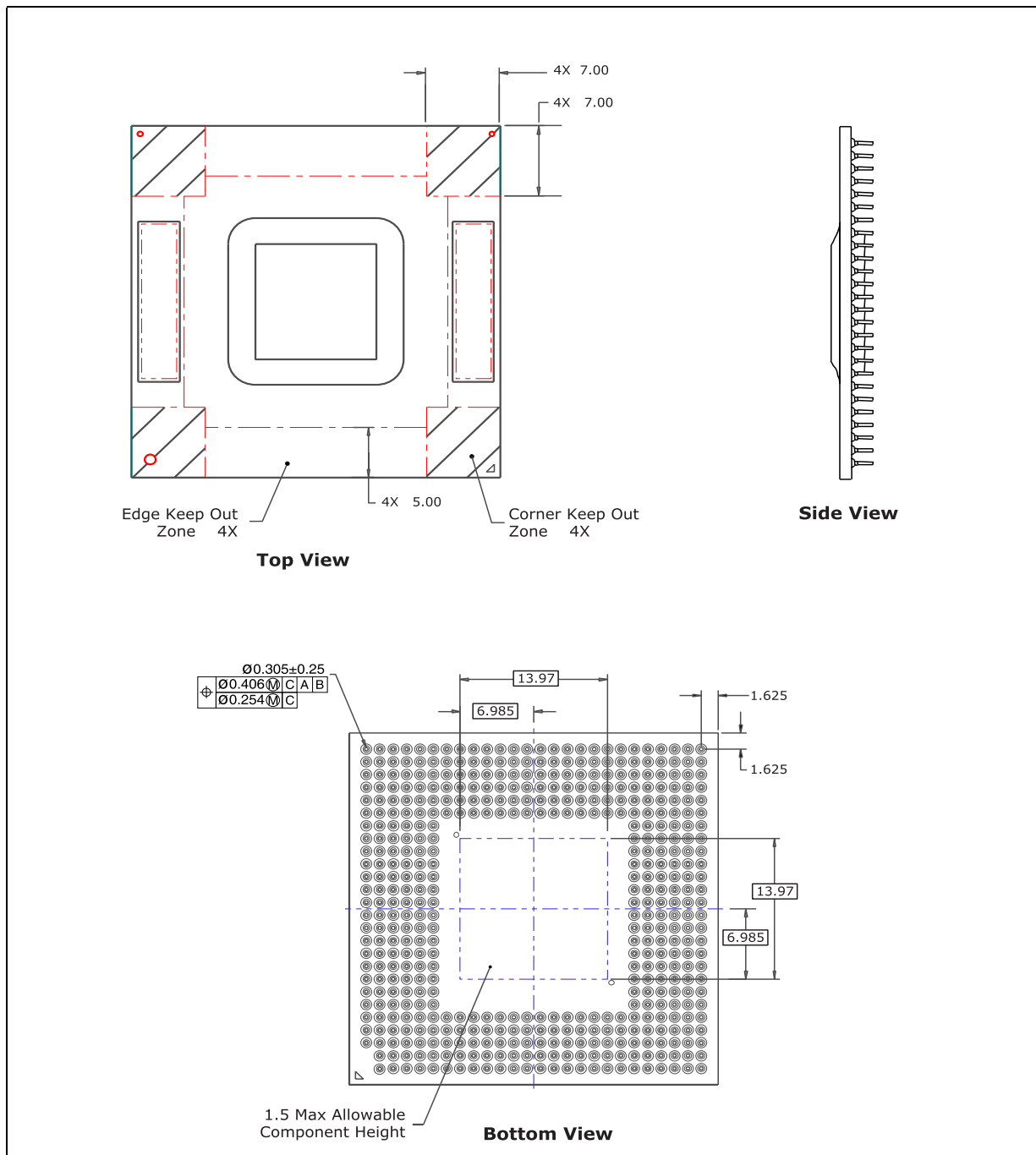

Figure 5. 2-MB Micro-FCPGA Processor Package Drawing (Sheet 1 of 2)

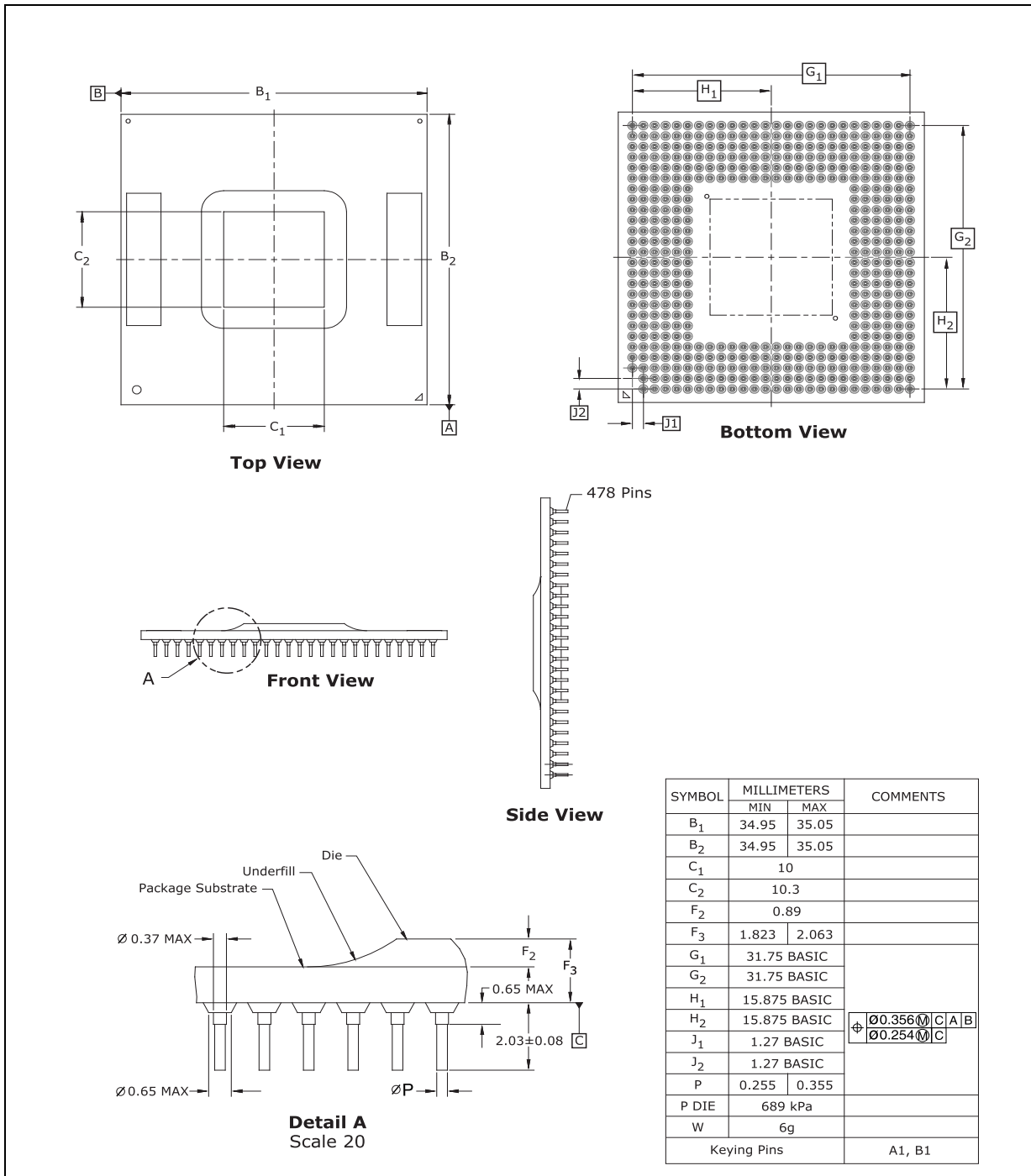



Figure 6. 2-MB Micro-FCPGA Processor Package Drawing (Sheet 2 of 2)

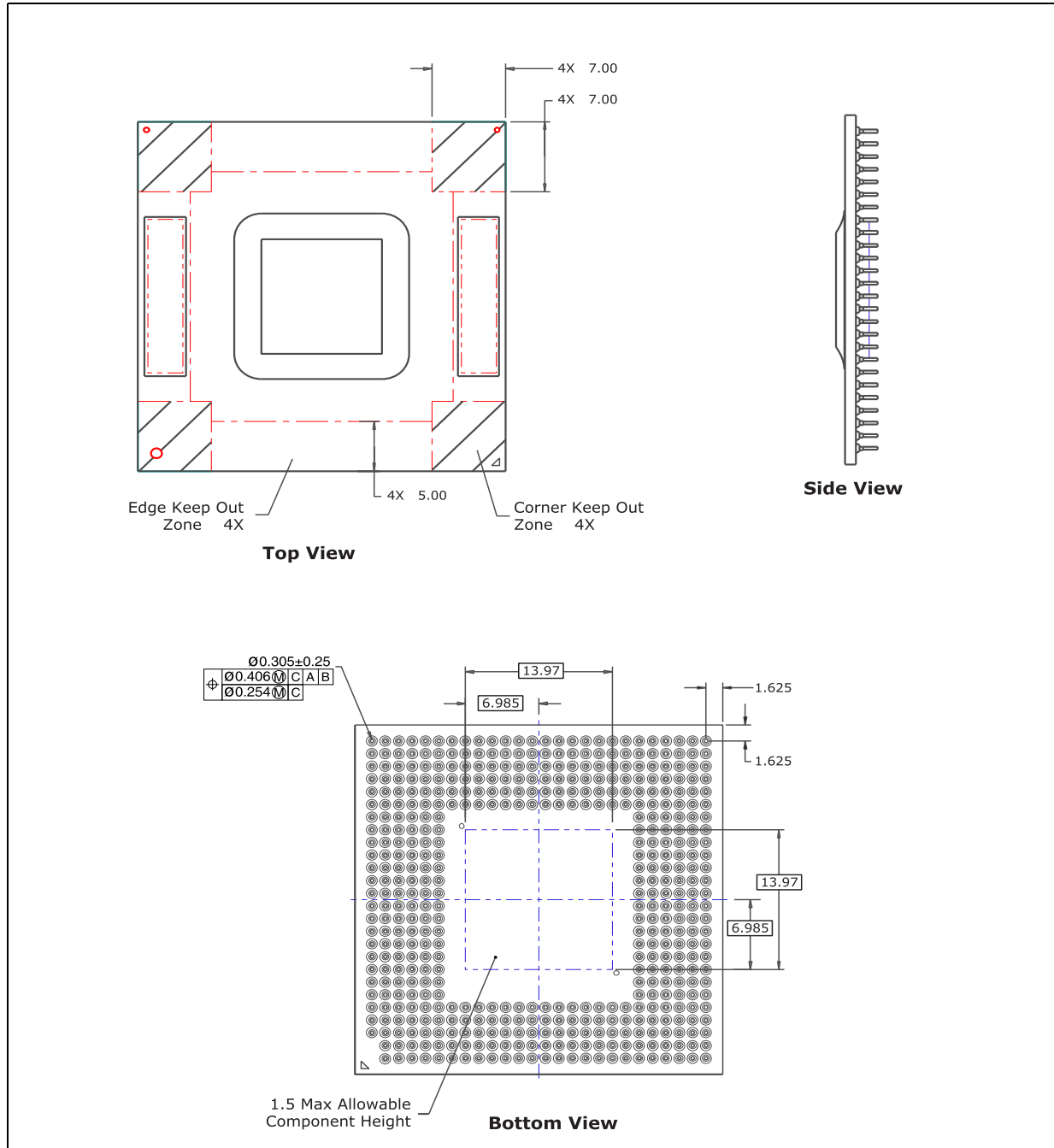
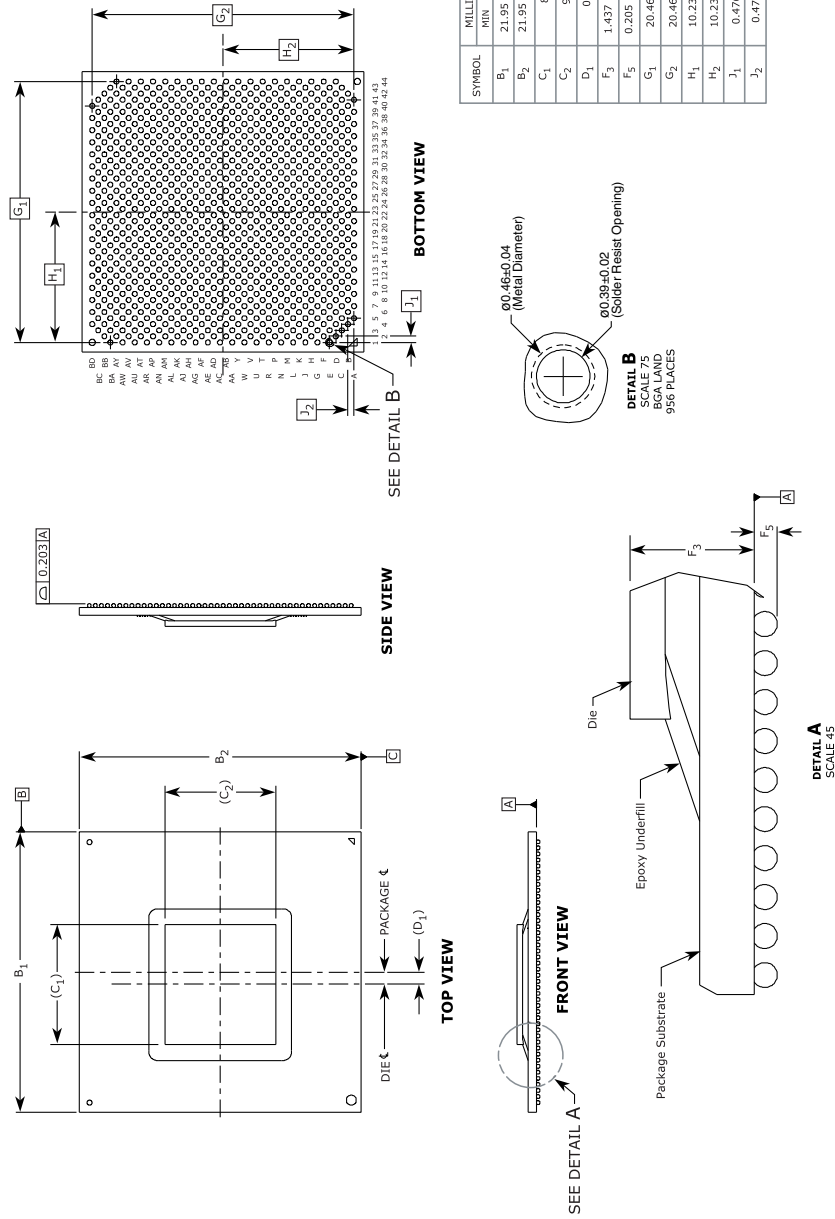



Figure 7. SFF (ULV DC) Die Micro-FCBGA Processor Package Drawing

THIS DRAWING CONTAINS INTEL CORPORATION CONFIDENTIAL INFORMATION. IT IS DISCLOSED IN CONFIDENCE AND ITS CONTENTS MAY NOT BE DISCLOSED, REPRODUCED, DISPLAYED OR MODIFIED, WITHOUT THE PRIOR WRITTEN CONSENT OF INTEL CORPORATION.



B6748-01
E36344(1)



4.2 Processor Pinout and Pin List

Table 13 shows the top view pinout of the Intel Celeron Dual-Core processor. The pin list, arranged in two different formats, is shown in the following pages.

Table 13. The Coordinates of the Processor Pins as Viewed from the Top of the Package (Sheet 1 of 2)

	1	2	3	4	5	6	7	8	9	10	11	12	13	
A		VSS	SMI#	VSS	FERR#	A20M#	VCC	VSS	VCC	VCC	VSS	VCC	VCC	A
B		RSVD	INIT#	LINT1	DPSP#	VSS	VCC	VSS	VCC	VCC	VSS	VCC	VSS	B
C	RESET#	VSS	RSVD	IGNNE#	VSS	LINT0	THERM TRIP#	VSS	VCC	VCC	VSS	VCC	VCC	C
D	VSS	RSVD	RSVD	VSS	STPCLK#	PWRGOD	SLP#	VSS	VCC	VCC	VSS	VCC	VSS	D
E	DBSY#	BNR#	VSS	HITM#	DPRSTP#	VSS	VCC	VSS	VCC	VCC	VSS	VCC	VCC	E
F	BR0#	VSS	RS[0]#	RS[1]#	VSS	RSVD	VCC	VSS	VCC	VCC	VSS	VCC	VSS	F
G	VSS	TRDY#	RS[2]#	VSS	BPRI#	HIT#							G	
H	ADS#	REQ[1]#	VSS	LOCK#	DEFER#	VSS							H	
J	A[9]#	VSS	REQ[3]#	A[3]#	VSS	VCCP							J	
K	VSS	REQ[2]#	REQ[0]#	VSS	A[6]#	VCCP							K	
L	REQ[4]#	A[13]#	VSS	A[5]#	A[4]#	VSS							L	
M	ADSTB[0]#	VSS	A[7]#	RSVD	VSS	VCCP							M	
N	VSS	A[8]#	A[10]#	VSS	RSVD	VCCP							N	
P	A[15]#	A[12]#	VSS	A[14]#	A[11]#	VSS							P	
R	A[16]#	VSS	A[19]#	A[24]#	VSS	VCCP							R	
T	VSS	RSVD	A[26]#	VSS	A[25]#	VCCP							T	
U	A[23]#	A[30]#	VSS	A[21]#	A[18]#	VSS	U							
V	ADSTB[1]#	VSS	RSVD	A[31]#	VSS	VCCP	V							
W	VSS	A[27]#	A[32]#	VSS	A[28]#	A[20]#	W							
Y	COMP[3]	A[17]#	VSS	A[29]#	A[22]#	VSS	Y							
AA	COMP[2]	VSS	A[35]#	A[33]#	VSS	TDI	VCC	VSS	VCC	VCC	VSS	VCC	VCC	AA
AB	VSS	A[34]#	TDO	VSS	TMS	TRST#	VCC	VSS	VCC	VCC	VSS	VCC	VSS	AB
AC	PREQ#	PRDY#	VSS	BPM[3]#	TCK	VSS	VCC	VSS	VCC	VCC	VSS	VCC	VCC	AC
AD	BPM[2]#	VSS	BPM[1]#	BPM[0]#	VSS	VID[0]	VCC	VSS	VCC	VCC	VSS	VCC	VSS	AD
AE	VSS	VID[6]	VID[4]	VSS	VID[2]	PSI#	VSS SENSE	VSS	VCC	VCC	VSS	VCC	VCC	AE
AF	TEST5	VSS	VID[5]	VID[3]	VID[1]	VSS	VCC SENSE	VSS	VCC	VCC	VSS	VCC	VSS	AF



Table 14. The Coordinates of the Processor Pins as Viewed from the Top of the Package (Sheet 2 of 2)

	14	15	16	17	18	19	20	21	22	23	24	25	26	
A	VSS	VCC	VSS	VCC	VCC	VSS	VCC	BCLK[1]	BCLK[0]	VSS	THRMDA	VSS	TEST6	A
B	VCC	VCC	VSS	VCC	VCC	VSS	VCC	VSS	BSEL[0]	BSEL[1]	VSS	THRMDC	VCCA	B
C	VSS	VCC	VSS	VCC	VCC	VSS	DBR#	BSEL[2]	VSS	TEST1	TEST3	VSS	VCCA	C
D	VCC	VCC	VSS	VCC	VCC	VSS	IERR#	PROCHOT#	RSVD	VSS	DPWR#	TEST2	VSS	D
E	VSS	VCC	VSS	VCC	VCC	VSS	VCC	VSS	D[0]#	D[7]#	VSS	D[6]#	D[2]#	E
F	VCC	VCC	VSS	VCC	VCC	VSS	VCC	DRDY#	VSS	D[4]#	D[1]#	VSS	D[13]#	F
G								VCCP	D[3]#	VSS	D[9]#	D[5]#	VSS	G
H								VSS	D[12]#	D[15]#	VSS	DINV[0]#	DSTBP[0]#	H
J								VCCP	VSS	D[11]#	D[10]#	VSS	DSTBN[0]#	J
K								VCCP	D[14]#	VSS	D[8]#	D[17]#	VSS	K
L								VSS	D[22]#	D[20]#	VSS	D[29]#	DSTBN[1]#	L
M								VCCP	VSS	D[23]#	D[21]#	VSS	DSTBP[1]#	M
N								VCCP	D[16]#	VSS	DINV[1]#	D[31]#	VSS	N
P								VSS	D[26]#	D[25]#	VSS	D[24]#	D[18]#	P
R								VCCP	VSS	D[19]#	D[28]#	VSS	COMP[0]	R
T								VCCP	D[37]#	VSS	D[27]#	D[30]#	VSS	T
U								VSS	DINV[2]#	D[39]#	VSS	D[38]#	COMP[1]	U
V								VCCP	VSS	D[36]#	D[34]#	VSS	D[35]#	V
W	VCCP	D[41]#	VSS	D[43]#	D[44]#	VSS	W							
Y	VSS	D[32]#	D[42]#	VSS	D[40]#	DSTBN[2]#	Y							
AA	VSS	VCC	VSS	VCC	VCC	VSS	VCC	D[50]#	VSS	D[45]#	D[46]#	VSS	DSTBP[2]#	AA
AB	VCC	VCC	VSS	VCC	VCC	VSS	VCC	D[52]#	D[51]#	VSS	D[33]#	D[47]#	VSS	AB
AC	VSS	VCC	VSS	VCC	VCC	VSS	DINV[3]#	VSS	D[60]#	D[63]#	VSS	D[57]#	D[53]#	AC
AD	VCC	VCC	VSS	VCC	VCC	VSS	D[54]#	D[59]#	VSS	D[61]#	D[49]#	VSS	GTLREF	AD
AE	VSS	VCC	VSS	VCC	VCC	VSS	VCC	D[58]#	D[55]#	VSS	D[48]#	DSTBN[3]#	VSS	AE
AF	VCC	VCC	VSS	VCC	VCC	VSS	VCC	VSS	D[62]#	D[56]#	DSTBP[3]#	VSS	TEST4	AF



Table 15. SFF Processor Top View Upper Left Side

	BD	BC	BB	BA	AY	AW	AV	AU	AT	AR	AP	AN	AM	AL	AK	AJ	AH	AG	AF	AE	AD	AC	
1				VSS		VSS		TDO		A[35]#		A[17]#		A[31]#		A[30]#		A[19]#		COMP[2]		A[16]#	
2			VSS		BPM[3]#		PREQ#		A[22]#		A[34]#		A[32]#		A[21]#		A[23]#		COMP[3]		A[11]#		
3		VSS		VSS		VSS		VSS		VSS		VSS		VSS		VSS		VSS		VSS		VSS	
4	VSS		VID[5]		VID[6]		TCK		A[20]#		A[28]#		A[27]#		A[18]#		A[26]#		A[24]#		A[12]#		
5		VID[4]		BPM[2]#		TMS		A[33]#		A[29]#		ADSTB[1]#		RSVD04		A[25]#		RSVD03		A[14]#		A[10]#	
6	VSS		VSS		VSS		VSS		VSS		VSS		VSS		VSS		VSS		VSS		VSS		VSS
7		VID[1]		BPM[1]#		TDI		VSS		VCCP		VCCP		VCCP		VCCP		VCCP		VCCP		VCCP	
8	VID[0]		VID[3]		BPM[0]#		TRST#		VSS		VSS		VSS		VSS		VSS		VSS		VSS		VSS
9		VSS		VSS		VSS		VSS		VCCP		VCCP		VCCP		VCCP		VCCP		VCCP		VCCP	
10	PSI#		VID[2]		TEST5		PRDY#		VSS		VCCP		VSS		VCCP		VSS		VCCP		VSS		VCCP
11		VSS		VSS		VSS		VCCP		VCCP		VCCP		VCCP		VCCP		VCCP		VCCP		VCCP	
12	VCCS ENSE		VSS		VSS		VSS		VSS		VCCP		VSS		VCCP		VSS		VCCP		VSS		VCCP
13		VSSSE NSE		VSS		VSS		VCCP		VCCP		VCCP		VCCP		VCCP		VCCP		VCCP		VCCP	
14	VCC		VCC		VCC		VCC		VCC		VCC		VCC		VCCP		VCCP		VCCP		VCCP		VCCP
15		VSS		VSS		VSS		VSS		VSS		VSS		VSS		VSS		VSS		VSS		VSS	
16	VCC		VCC		VCC		VCC		VCC		VCC		VCC		VCC		VCC		VCC		VCC		VCC
17		VSS		VSS		VSS		VSS		VSS		VSS		VSS		VSS		VSS		VSS		VSS	
18	VCC		VCC		VCC		VCC		VCC		VCC		VCC		VCC		VCC		VCC		VCC		VCC
19		VSS		VSS		VSS		VSS		VSS		VSS		VSS		VSS		VSS		VSS		VSS	
20	VCC		VCC		VCC		VCC		VCC		VCC		VCC		VCC		VCC		VCC		VCC		VCC
21		VSS		VSS		VSS		VSS		VSS		VSS		VSS		VSS		VSS		VSS		VSS	
22	VCC		VCC		VCC		VCC		VCC		VCC		VCC		VCC		VCC		VCC		VCC		VCC



Table 16. SFF Processor Top View Upper Right Side

	AB	AA	Y	W	V	U	T	R	P	N	M	L	K	J	H	G	F	E	D	C	B	A
1		A[7]#		A[5]#	REQ[2]#		REQ[0]#	LOCK#	TRDY#		DBSY#		VSS		VSS							
2	A[15]#		RSVD0_2	RSVD0_1		A[9]#		A[3]#		BRO#		RS[0]#		HIT#		HITM#		VSS				
3		VSS		VSS		VSS		VSS		VSS		VSS		VSS		VSS		VSS		VSS		
4	A[8]#		ADSTB[0]#	A[4]#		A[6]#		REQ[3]#	ADS#		RS[2]#		RS[1]#		RSVD0_6		FERR#		VSS			
5		A[13]#		REQ[4]#		VSS		REQ[1]#	DEFER#		BPRI#		BNR#		RESET#		SMI#		LINT1		VSS	
6	VSS		VSS	VSS		VSS		VSS		VSS		VSS		VSS		VSS		VSS		VSS		
7		VCCP		VCCP		VCCP		VCCP		VCCP		VCCP		DBR#		DPRSTP#		PWRG OOD		A20M#		VSS
8	VSS		VSS	VSS		VSS		VSS		VSS		VSS		RSVD0_7		STPCLK#		INIT#		DPSLP#		
9		VCCP		VCCP		VCCP		VCCP		VCCP		VCCP		RSVD0_5		VSS		VSS		LINT0		VSS
10	VCCP		VSS	VCCP		VSS		VCCP		VSS		VCCP		VSS		IGNNE#		SLP#		TRIP#		
11		VCCP		VCCP		VCCP		VCCP		VCCP		VCCP		VCCP		VCCP		VCCP		VSS		VSS
12	VCCP		VSS	VCCP		VSS		VCCP		VSS		VCCP		VCCP		VCCP		VCCP		VCCP		VCCP
13		VCCP		VCCP		VCCP		VCCP		VCCP		VCCP		VCCP		VCCP		VCCP		VCCP		VCCP
14	VCCP		VCCP	VCCP		VCCP		VCCP		VCCP		VCCP		VCCP		VCCP		VCCP		VCCP		VCCP
15		VSS		VSS		VSS		VSS		VSS		VSS		VSS		VSS		VSS		VSS		VSS
16	VCC		VCC	VCC		VCC		VCC		VCC		VCC		VCC		VCC		VCC		VCC		VCC
17		VSS		VSS		VSS		VSS		VSS		VSS		VSS		VSS		VSS		VSS		VSS
18	VCC		VCC	VCC		VCC		VCC		VCC		VCC		VCC		VCC		VCC		VCC		VCC
19		VSS		VSS		VSS		VSS		VSS		VSS		VSS		VSS		VSS		VSS		VSS
20	VCC		VCC	VCC		VCC		VCC		VCC		VCC		VCC		VCC		VCC		VCC		VCC
21		VSS		VSS		VSS		VSS		VSS		VSS		VSS		VSS		VSS		VSS		VSS
22	VCC		VCC	VCC		VCC		VCC		VCC		VCC		VCC		VCC		VCC		VCC		VCC



Table 17. SFF Processor Top View Lower Left Side

	BD	BC	BB	BA	AY	AW	AV	AU	AT	AR	AP	AN	AM	AL	AK	AJ	AH	AG	AF	AE	AD	AC	
23		VSS		VSS		VSS		VSS		VSS		VSS		VSS		VSS		VSS		VSS		VSS	
24	VCC		VCC		VCC		VCC		VCC		VCC		VCC		VCC		VCC		VCC		VCC		VCC
25		VSS		VSS		VSS		VSS		VSS		VSS		VSS		VSS		VSS		VSS		VSS	
26	VCC		VCC		VCC		VCC		VCC		VCC		VCC		VCC		VCC		VCC		VCC		VCC
27		VSS		VSS		VSS		VSS		VSS		VSS		VSS		VSS		VSS		VSS		VSS	
28	VCC		VCC		VCC		VCC		VCC		VCC		VCC		VCC		VCC		VCC		VCC		VCC
29		VSS		VSS		VSS		VSS		VSS		VSS		VSS		VSS		VSS		VSS		VSS	
30	VCC		VCC		VCC		VCC		VCC		VCC		VCC		VCC		VCC		VCC		VCC		VCC
31		VSS		VSS		VSS		VSS		VSS		VSS		VSS		VSS		VSS		VSS		VSS	
32	VCC		VCC		VCC		VCC		VCC		VCC		VCC		VCC		VCC		VCC		VCC		VCC
33		VSS		VSS		VSS		VCC		VCC		VCC		VCC		VCC		VCC		VCC		VCC	
34	THRM DC		THRM DA		VSS		VSS		VCC		VSS		VSS		VSS		VSS		VSS		VSS		VSS
35		D[58]#		D[62]#		VSS		VSS		VSS		VCCP		VCCP		VCCP		VCCP		VCCP		VCCP	
36	VSS		VSS		D[56]#		VSS		VSS		VCCP		VSS		VCCP		VSS		VCCP		VSS		VCCP
37		DINV[3] #		D[54]#		VSS		VSS		VSS		VCCP		VCCP		VCCP		VCCP		VCCP		VCCP	
38	VSS		D[55]#		DSTBP [3]#		D[48]#		VSS		VCCP		VSS		VCCP		VSS		VCCP		VSS		VCCP
39		D[59]#		VSS		VSS		VSS		VSS		VSS		VSS		VSS		VSS		VSS		VSS	
40	VSS		D[61]#		DSTBN [3]#		D[50]#		D[57]#		D[45]#		D[42]#		D[43]#		D[34]#		D[35]#		D[26]#		
41		VSS		D[60]#		D[52]#		D[51]#		D[53]#		D[46]#		D[47]#		DINV[2] #		D[37]#		TEST4		D[27]#	
42			VSS		VSS		VSS		VSS		VSS		VSS		VSS		VSS		VSS		VSS		VSS
43				VSS		GTLRE F		D[63]#		D[33]#		D[41]#		DSTBP [2]#		D[36]#		D[44]#		COMP[0]		TEST6	
44					VSS		VSS		D[49]#		D[32]#		D[40]#		DSTBN [2]#		D[39]#		D[38]#		COMP[1]		



Table 18. SFF Processor Top View Lower Right Side

	AB	AA	Y	W	V	U	T	R	P	N	M	L	K	J	H	G	F	E	D	C	B	A
23		VSS		VSS		VSS		VSS		VSS		VSS		VSS		VSS		VSS		VSS		VSS
24	VCC		VCC		VCC		VCC		VCC		VCC		VCC		VCC		VCC		VCC		VCC	
25		VSS		VSS		VSS		VSS		VSS		VSS		VSS		VSS		VSS		VSS		VSS
26	VCC		VCC		VCC		VCC		VCC		VCC		VCC		VCC		VCC		VCC		VCC	
27		VSS		VSS		VSS		VSS		VSS		VSS		VSS		VSS		VSS		VSS		VSS
28	VCC		VCC		VCC		VCC		VCC		VCC		VCC		VCC		VCC		VCC		VCC	
29		VSS		VSS		VSS		VSS		VSS		VSS		VSS		VSS		VSS		VSS		VSS
30	VCC		VCC		VCC		VCC		VCC		VCC		VCC		VCC		VCC		VCC		VCC	
31		VSS		VSS		VSS		VSS		VSS		VSS		VSS		VSS		VSS		VSS		VSS
32	VCC		VCC		VCC		VCC		VCC		VCC		VCC		VCC		VCC		VCCP		VCCP	
33		VCC		VCC		VCC		VCC		VCC		VCC		VCC		VCC		VCCP		VCCP		VCCP
34	VSS		VSS		VSS		VSS		VSS		VSS		VSS		VSS		VCCP		VCCA		VCCA	
35		VCCP		VCCP		VCCP		VCCP		VCCP		VCCP		VCCP		VCCP		VCCP		BCLK[1]		BCLK[0]
36	VCCP		VSS		VCCP		VSS		VCCP		VSS		VCCP		VCCP		VCCP		VSS		VSS	
37		VCCP		VCCP		VCCP		VCCP		VCCP		VCCP		VCCP		VSS		TEST1		BSEL[1]		BSEL[0]
38	VCCP		VSS		VCCP		VSS		VCCP		VSS		VCCP		VSS		DRDY#		PROC HOT#		BSEL[2]	
39		VSS		VSS		VSS		VSS		VSS		VSS		VSS		D[6]#		VSS		VSS		VSS
40	D[25]#		D[29]#		D[17]#		D[11]#		DINV[0]#		D[12]#		DSTBN[0]#		D[4]#		D[0]#		TEST2		IERR#	
41		D[24]#		D[21]#		D[23]#		D[20]#		D[10]#		D[8]#		DSTBP[0]#		D[13]#		D[7]#		DPWR#		VSS
42	VSS		VSS		VSS		VSS		VSS		VSS		VSS		VSS		VSS		VSS		VSS	
43		D[28]#		DSTBP[1]#		DSTBN[1]#		DINV[1]#		D[22]#		D[15]#		D[3]#		D[1]#		D[2]#		TEST3		
44	D[19]#		D[30]#		D[18]#		D[31]#		D[16]#		D[14]#		D[9]#		D[5]#		VSS		VSS			



Table 19. Pin Listing by Pin Name (Sheet 1 of 16)

Pin Name	Pin Number	Signal Buffer Type	Direction
A[3]#	J4	Source Synch	Input/Output
A[4]#	L5	Source Synch	Input/Output
A[5]#	L4	Source Synch	Input/Output
A[6]#	K5	Source Synch	Input/Output
A[7]#	M3	Source Synch	Input/Output
A[8]#	N2	Source Synch	Input/Output
A[9]#	J1	Source Synch	Input/Output
A[10]#	N3	Source Synch	Input/Output
A[11]#	P5	Source Synch	Input/Output
A[12]#	P2	Source Synch	Input/Output
A[13]#	L2	Source Synch	Input/Output
A[14]#	P4	Source Synch	Input/Output
A[15]#	P1	Source Synch	Input/Output
A[16]#	R1	Source Synch	Input/Output
A[17]#	Y2	Source Synch	Input/Output
A[18]#	U5	Source Synch	Input/Output
A[19]#	R3	Source Synch	Input/Output
A[20]#	W6	Source Synch	Input/Output
A[21]#	U4	Source Synch	Input/Output
A[22]#	Y5	Source Synch	Input/Output
A[23]#	U1	Source Synch	Input/Output

Table 19. Pin Listing by Pin Name (Sheet 2 of 16)

Pin Name	Pin Number	Signal Buffer Type	Direction
A[24]#	R4	Source Synch	Input/Output
A[25]#	T5	Source Synch	Input/Output
A[26]#	T3	Source Synch	Input/Output
A[27]#	W2	Source Synch	Input/Output
A[28]#	W5	Source Synch	Input/Output
A[29]#	Y4	Source Synch	Input/Output
A[30]#	U2	Source Synch	Input/Output
A[31]#	V4	Source Synch	Input/Output
A[32]#	W3	Source Synch	Input/Output
A[33]#	AA4	Source Synch	Input/Output
A[34]#	AB2	Source Synch	Input/Output
A[35]#	AA3	Source Synch	Input/Output
A20M#	A6	CMOS	Input
ADS#	H1	Common Clock	Input/Output
ADSTB[0]#	M1	Source Synch	Input/Output
ADSTB[1]#	V1	Source Synch	Input/Output
BCLK[0]	A22	Bus Clock	Input
BCLK[1]	A21	Bus Clock	Input
BNR#	E2	Common Clock	Input/Output
BPM[0]#	AD4	Common Clock	Input/Output
BPM[1]#	AD3	Common Clock	Output
BPM[2]#	AD1	Common Clock	Output
BPM[3]#	AC4	Common Clock	Input/Output
BPRI#	G5	Common Clock	Input



Table 19. Pin Listing by Pin Name (Sheet 3 of 16)

Pin Name	Pin Number	Signal Buffer Type	Direction
BR0#	F1	Common Clock	Input/Output
BSEL[0]	B22	CMOS	Output
BSEL[1]	B23	CMOS	Output
BSEL[2]	C21	CMOS	Output
COMP[0]	R26	Power/Other	Input/Output
COMP[1]	U26	Power/Other	Input/Output
COMP[2]	AA1	Power/Other	Input/Output
COMP[3]	Y1	Power/Other	Input/Output
D[0]#	E22	Source Synch	Input/Output
D[1]#	F24	Source Synch	Input/Output
D[2]#	E26	Source Synch	Input/Output
D[3]#	G22	Source Synch	Input/Output
D[4]#	F23	Source Synch	Input/Output
D[5]#	G25	Source Synch	Input/Output
D[6]#	E25	Source Synch	Input/Output
D[7]#	E23	Source Synch	Input/Output
D[8]#	K24	Source Synch	Input/Output
D[9]#	G24	Source Synch	Input/Output
D[10]#	J24	Source Synch	Input/Output
D[11]#	J23	Source Synch	Input/Output
D[12]#	H22	Source Synch	Input/Output
D[13]#	F26	Source Synch	Input/Output
D[14]#	K22	Source Synch	Input/Output

Table 19. Pin Listing by Pin Name (Sheet 4 of 16)

Pin Name	Pin Number	Signal Buffer Type	Direction
D[15]#	H23	Source Synch	Input/Output
D[16]#	N22	Source Synch	Input/Output
D[17]#	K25	Source Synch	Input/Output
D[18]#	P26	Source Synch	Input/Output
D[19]#	R23	Source Synch	Input/Output
D[20]#	L23	Source Synch	Input/Output
D[21]#	M24	Source Synch	Input/Output
D[22]#	L22	Source Synch	Input/Output
D[23]#	M23	Source Synch	Input/Output
D[24]#	P25	Source Synch	Input/Output
D[25]#	P23	Source Synch	Input/Output
D[26]#	P22	Source Synch	Input/Output
D[27]#	T24	Source Synch	Input/Output
D[28]#	R24	Source Synch	Input/Output
D[29]#	L25	Source Synch	Input/Output
D[30]#	T25	Source Synch	Input/Output
D[31]#	N25	Source Synch	Input/Output
D[32]#	Y22	Source Synch	Input/Output
D[33]#	AB24	Source Synch	Input/Output
D[34]#	V24	Source Synch	Input/Output
D[35]#	V26	Source Synch	Input/Output
D[36]#	V23	Source Synch	Input/Output



Table 19. Pin Listing by Pin Name (Sheet 5 of 16)

Pin Name	Pin Number	Signal Buffer Type	Direction
D[37]#	T22	Source Synch	Input/Output
D[38]#	U25	Source Synch	Input/Output
D[39]#	U23	Source Synch	Input/Output
D[40]#	Y25	Source Synch	Input/Output
D[41]#	W22	Source Synch	Input/Output
D[42]#	Y23	Source Synch	Input/Output
D[43]#	W24	Source Synch	Input/Output
D[44]#	W25	Source Synch	Input/Output
D[45]#	AA23	Source Synch	Input/Output
D[46]#	AA24	Source Synch	Input/Output
D[47]#	AB25	Source Synch	Input/Output
D[48]#	AE24	Source Synch	Input/Output
D[49]#	AD24	Source Synch	Input/Output
D[50]#	AA21	Source Synch	Input/Output
D[51]#	AB22	Source Synch	Input/Output
D[52]#	AB21	Source Synch	Input/Output
D[53]#	AC26	Source Synch	Input/Output
D[54]#	AD20	Source Synch	Input/Output
D[55]#	AE22	Source Synch	Input/Output
D[56]#	AF23	Source Synch	Input/Output
D[57]#	AC25	Source Synch	Input/Output
D[58]#	AE21	Source Synch	Input/Output

Table 19. Pin Listing by Pin Name (Sheet 6 of 16)

Pin Name	Pin Number	Signal Buffer Type	Direction
D[59]#	AD21	Source Synch	Input/Output
D[60]#	AC22	Source Synch	Input/Output
D[61]#	AD23	Source Synch	Input/Output
D[62]#	AF22	Source Synch	Input/Output
D[63]#	AC23	Source Synch	Input/Output
DBR#	C20	CMOS	Output
DBSY#	E1	Common Clock	Input/Output
DEFER#	H5	Common Clock	Input
DINV[0]#	H25	Source Synch	Input/Output
DINV[1]#	N24	Source Synch	Input/Output
DINV[2]#	U22	Source Synch	Input/Output
DINV[3]#	AC20	Source Synch	Input/Output
DPRSTP#	E5	CMOS	Input
DPSLP#	B5	CMOS	Input
DPWR#	D24	Common Clock	Input/Output
DRDY#	F21	Common Clock	Input/Output
DSTBN[0]#	J26	Source Synch	Input/Output
DSTBN[1]#	L26	Source Synch	Input/Output
DSTBN[2]#	Y26	Source Synch	Input/Output
DSTBN[3]#	AE25	Source Synch	Input/Output
DSTBP[0]#	H26	Source Synch	Input/Output
DSTBP[1]#	M26	Source Synch	Input/Output
DSTBP[2]#	AA26	Source Synch	Input/Output



Table 19. Pin Listing by Pin Name (Sheet 7 of 16)

Pin Name	Pin Number	Signal Buffer Type	Direction
DSTBP[3]#	AF24	Source Synch	Input/Output
FERR#	A5	Open Drain	Output
GTLREF	AD26	Power/Other	Input
HIT#	G6	Common Clock	Input/Output
HITM#	E4	Common Clock	Input/Output
IERR#	D20	Open Drain	Output
IGNNE#	C4	CMOS	Input
INIT#	B3	CMOS	Input
LINT0	C6	CMOS	Input
LINT1	B4	CMOS	Input
LOCK#	H4	Common Clock	Input/Output
PRDY#	AC2	Common Clock	Output
PREQ#	AC1	Common Clock	Input
PROCHOT#	D21	Open Drain	Input/Output
PSI#	AE6	CMOS	Output
PWRGOOD	D6	CMOS	Input
REQ[0]#	K3	Source Synch	Input/Output
REQ[1]#	H2	Source Synch	Input/Output
REQ[2]#	K2	Source Synch	Input/Output
REQ[3]#	J3	Source Synch	Input/Output
REQ[4]#	L1	Source Synch	Input/Output
RESET#	C1	Common Clock	Input
RS[0]#	F3	Common Clock	Input
RS[1]#	F4	Common Clock	Input
RS[2]#	G3	Common Clock	Input
RSVD	B2	Reserved	
RSVD	C3	Reserved	
RSVD	D2	Reserved	
RSVD	D3	Reserved	
RSVD	D22	Reserved	

Table 19. Pin Listing by Pin Name (Sheet 8 of 16)

Pin Name	Pin Number	Signal Buffer Type	Direction
RSVD	F6	Reserved	
RSVD	M4	Reserved	
RSVD	N5	Reserved	
RSVD	T2	Reserved	
RSVD	V3	Reserved	
SLP#	D7	CMOS	Input
SMI#	A3	CMOS	Input
STPCLK#	D5	CMOS	Input
TCK	AC5	CMOS	Input
TDI	AA6	CMOS	Input
TDO	AB3	Open Drain	Output
TEST1	C23	Test	
TEST2	D25	Test	
TEST3	C24	Test	
TEST4	AF26	Test	
TEST5	AF1	Test	
TEST6	A26	Test	
THERMTRIP #	C7	Open Drain	Output
THRMADA	A24	Power/Other	
THRMDC	B25	Power/Other	
TMS	AB5	CMOS	Input
TRDY#	G2	Common Clock	Input
TRST#	AB6	CMOS	Input
VCC	A7	Power/Other	
VCC	A9	Power/Other	
VCC	A10	Power/Other	
VCC	A12	Power/Other	
VCC	A13	Power/Other	
VCC	A15	Power/Other	
VCC	A17	Power/Other	
VCC	A18	Power/Other	
VCC	A20	Power/Other	
VCC	AA7	Power/Other	
VCC	AA9	Power/Other	
VCC	AA10	Power/Other	
VCC	AA12	Power/Other	



Table 19. Pin Listing by Pin Name (Sheet 9 of 16)

Pin Name	Pin Number	Signal Buffer Type	Direction
VCC	AA13	Power/Other	
VCC	AA15	Power/Other	
VCC	AA17	Power/Other	
VCC	AA18	Power/Other	
VCC	AA20	Power/Other	
VCC	AB7	Power/Other	
VCC	AB9	Power/Other	
VCC	AB10	Power/Other	
VCC	AB12	Power/Other	
VCC	AB14	Power/Other	
VCC	AB15	Power/Other	
VCC	AB17	Power/Other	
VCC	AB18	Power/Other	
VCC	AB20	Power/Other	
VCC	AC7	Power/Other	
VCC	AC9	Power/Other	
VCC	AC10	Power/Other	
VCC	AC12	Power/Other	
VCC	AC13	Power/Other	
VCC	AC15	Power/Other	
VCC	AC17	Power/Other	
VCC	AC18	Power/Other	
VCC	AD7	Power/Other	
VCC	AD9	Power/Other	
VCC	AD10	Power/Other	
VCC	AD12	Power/Other	
VCC	AD14	Power/Other	
VCC	AD15	Power/Other	
VCC	AD17	Power/Other	
VCC	AD18	Power/Other	
VCC	AE9	Power/Other	
VCC	AE10	Power/Other	
VCC	AE12	Power/Other	
VCC	AE13	Power/Other	
VCC	AE15	Power/Other	
VCC	AE17	Power/Other	

Table 19. Pin Listing by Pin Name (Sheet 10 of 16)

Pin Name	Pin Number	Signal Buffer Type	Direction
VCC	AE18	Power/Other	
VCC	AE20	Power/Other	
VCC	AF9	Power/Other	
VCC	AF10	Power/Other	
VCC	AF12	Power/Other	
VCC	AF14	Power/Other	
VCC	AF15	Power/Other	
VCC	AF17	Power/Other	
VCC	AF18	Power/Other	
VCC	AF20	Power/Other	
VCC	B7	Power/Other	
VCC	B9	Power/Other	
VCC	B10	Power/Other	
VCC	B12	Power/Other	
VCC	B14	Power/Other	
VCC	B15	Power/Other	
VCC	B17	Power/Other	
VCC	B18	Power/Other	
VCC	B20	Power/Other	
VCC	C9	Power/Other	
VCC	C10	Power/Other	
VCC	C12	Power/Other	
VCC	C13	Power/Other	
VCC	C15	Power/Other	
VCC	C17	Power/Other	
VCC	C18	Power/Other	
VCC	D9	Power/Other	
VCC	D10	Power/Other	
VCC	D12	Power/Other	
VCC	D14	Power/Other	
VCC	D15	Power/Other	
VCC	D17	Power/Other	
VCC	D18	Power/Other	
VCC	E7	Power/Other	
VCC	E9	Power/Other	
VCC	E10	Power/Other	



Table 19. Pin Listing by Pin Name (Sheet 11 of 16)

Pin Name	Pin Number	Signal Buffer Type	Direction
VCC	E12	Power/Other	
VCC	E13	Power/Other	
VCC	E15	Power/Other	
VCC	E17	Power/Other	
VCC	E18	Power/Other	
VCC	E20	Power/Other	
VCC	F7	Power/Other	
VCC	F9	Power/Other	
VCC	F10	Power/Other	
VCC	F12	Power/Other	
VCC	F14	Power/Other	
VCC	F15	Power/Other	
VCC	F17	Power/Other	
VCC	F18	Power/Other	
VCC	F20	Power/Other	
VCCA	B26	Power/Other	
VCCA	C26	Power/Other	
VCCP	G21	Power/Other	
VCCP	J6	Power/Other	
VCCP	J21	Power/Other	
VCCP	K6	Power/Other	
VCCP	K21	Power/Other	
VCCP	M6	Power/Other	
VCCP	M21	Power/Other	
VCCP	N6	Power/Other	
VCCP	N21	Power/Other	
VCCP	R6	Power/Other	
VCCP	R21	Power/Other	
VCCP	T6	Power/Other	
VCCP	T21	Power/Other	
VCCP	V6	Power/Other	
VCCP	V21	Power/Other	
VCCP	W21	Power/Other	
VCCSENSE	AF7	Power/Other	
VID[0]	AD6	CMOS	Output
VID[1]	AF5	CMOS	Output

Table 19. Pin Listing by Pin Name (Sheet 12 of 16)

Pin Name	Pin Number	Signal Buffer Type	Direction
VID[2]	AE5	CMOS	Output
VID[3]	AF4	CMOS	Output
VID[4]	AE3	CMOS	Output
VID[5]	AF3	CMOS	Output
VID[6]	AE2	CMOS	Output
VSS	A2	Power/Other	
VSS	A4	Power/Other	
VSS	A8	Power/Other	
VSS	A11	Power/Other	
VSS	A14	Power/Other	
VSS	A16	Power/Other	
VSS	A19	Power/Other	
VSS	A23	Power/Other	
VSS	A25	Power/Other	
VSS	AA2	Power/Other	
VSS	AA5	Power/Other	
VSS	AA8	Power/Other	
VSS	AA11	Power/Other	
VSS	AA14	Power/Other	
VSS	AA16	Power/Other	
VSS	AA19	Power/Other	
VSS	AA22	Power/Other	
VSS	AA25	Power/Other	
VSS	AB1	Power/Other	
VSS	AB4	Power/Other	
VSS	AB8	Power/Other	
VSS	AB11	Power/Other	
VSS	AB13	Power/Other	
VSS	AB16	Power/Other	
VSS	AB19	Power/Other	
VSS	AB23	Power/Other	
VSS	AB26	Power/Other	
VSS	AC3	Power/Other	
VSS	AC6	Power/Other	
VSS	AC8	Power/Other	
VSS	AC11	Power/Other	



Table 19. Pin Listing by Pin Name (Sheet 13 of 16)

Pin Name	Pin Number	Signal Buffer Type	Direction
VSS	AC14	Power/Other	
VSS	AC16	Power/Other	
VSS	AC19	Power/Other	
VSS	AC21	Power/Other	
VSS	AC24	Power/Other	
VSS	AD2	Power/Other	
VSS	AD5	Power/Other	
VSS	AD8	Power/Other	
VSS	AD11	Power/Other	
VSS	AD13	Power/Other	
VSS	AD16	Power/Other	
VSS	AD19	Power/Other	
VSS	AD22	Power/Other	
VSS	AD25	Power/Other	
VSS	AE1	Power/Other	
VSS	AE4	Power/Other	
VSS	AE8	Power/Other	
VSS	AE11	Power/Other	
VSS	AE14	Power/Other	
VSS	AE16	Power/Other	
VSS	AE19	Power/Other	
VSS	AE23	Power/Other	
VSS	AE26	Power/Other	
VSS	AF2	Power/Other	
VSS	AF6	Power/Other	
VSS	AF8	Power/Other	
VSS	AF11	Power/Other	
VSS	AF13	Power/Other	
VSS	AF16	Power/Other	
VSS	AF19	Power/Other	
VSS	AF21	Power/Other	
VSS	AF25	Power/Other	
VSS	B6	Power/Other	
VSS	B8	Power/Other	
VSS	B11	Power/Other	
VSS	B13	Power/Other	

Table 19. Pin Listing by Pin Name (Sheet 14 of 16)

Pin Name	Pin Number	Signal Buffer Type	Direction
VSS	B16	Power/Other	
VSS	B19	Power/Other	
VSS	B21	Power/Other	
VSS	B24	Power/Other	
VSS	C2	Power/Other	
VSS	C5	Power/Other	
VSS	C8	Power/Other	
VSS	C11	Power/Other	
VSS	C14	Power/Other	
VSS	C16	Power/Other	
VSS	C19	Power/Other	
VSS	C22	Power/Other	
VSS	C25	Power/Other	
VSS	D1	Power/Other	
VSS	D4	Power/Other	
VSS	D8	Power/Other	
VSS	D11	Power/Other	
VSS	D13	Power/Other	
VSS	D16	Power/Other	
VSS	D19	Power/Other	
VSS	D23	Power/Other	
VSS	D26	Power/Other	
VSS	E3	Power/Other	
VSS	E6	Power/Other	
VSS	E8	Power/Other	
VSS	E11	Power/Other	
VSS	E14	Power/Other	
VSS	E16	Power/Other	
VSS	E19	Power/Other	
VSS	E21	Power/Other	
VSS	E24	Power/Other	
VSS	F2	Power/Other	
VSS	F5	Power/Other	
VSS	F8	Power/Other	
VSS	F11	Power/Other	
VSS	F13	Power/Other	



Table 19. Pin Listing by Pin Name (Sheet 15 of 16)

Pin Name	Pin Number	Signal Buffer Type	Direction
VSS	F16	Power/Other	
VSS	F19	Power/Other	
VSS	F22	Power/Other	
VSS	F25	Power/Other	
VSS	G1	Power/Other	
VSS	G4	Power/Other	
VSS	G23	Power/Other	
VSS	G26	Power/Other	
VSS	H3	Power/Other	
VSS	H6	Power/Other	
VSS	H21	Power/Other	
VSS	H24	Power/Other	
VSS	J2	Power/Other	
VSS	J5	Power/Other	
VSS	J22	Power/Other	
VSS	J25	Power/Other	
VSS	K1	Power/Other	
VSS	K4	Power/Other	
VSS	K23	Power/Other	
VSS	K26	Power/Other	
VSS	L3	Power/Other	
VSS	L6	Power/Other	
VSS	L21	Power/Other	
VSS	L24	Power/Other	
VSS	M2	Power/Other	
VSS	M5	Power/Other	
VSS	M22	Power/Other	
VSS	M25	Power/Other	
VSS	N1	Power/Other	
VSS	N4	Power/Other	
VSS	N23	Power/Other	
VSS	N26	Power/Other	
VSS	P3	Power/Other	
VSS	P6	Power/Other	
VSS	P21	Power/Other	
VSS	P24	Power/Other	

Table 19. Pin Listing by Pin Name (Sheet 16 of 16)

Pin Name	Pin Number	Signal Buffer Type	Direction
VSS	R2	Power/Other	
VSS	R5	Power/Other	
VSS	R22	Power/Other	
VSS	R25	Power/Other	
VSS	T1	Power/Other	
VSS	T4	Power/Other	
VSS	T23	Power/Other	
VSS	T26	Power/Other	
VSS	U3	Power/Other	
VSS	U6	Power/Other	
VSS	U21	Power/Other	
VSS	U24	Power/Other	
VSS	V2	Power/Other	
VSS	V5	Power/Other	
VSS	V22	Power/Other	
VSS	V25	Power/Other	
VSS	W1	Power/Other	
VSS	W4	Power/Other	
VSS	W23	Power/Other	
VSS	W26	Power/Other	
VSS	Y3	Power/Other	
VSS	Y6	Power/Other	
VSS	Y21	Power/Other	
VSS	Y24	Power/Other	
VSSSENSE	AE7	Power/Other	Output

Table 20. Pin Listing by Pin Number (Sheet 1 of 17)

Pin Name	Pin Number	Signal Buffer Type	Direction
VSS	A2	Power/Other	
SMI#	A3	CMOS	Input
VSS	A4	Power/Other	
FERR#	A5	Open Drain	Output
A20M#	A6	CMOS	Input
VCC	A7	Power/Other	



Table 20. Pin Listing by Pin Number (Sheet 2 of 17)

Pin Name	Pin Number	Signal Buffer Type	Direction
VSS	A8	Power/Other	
VCC	A9	Power/Other	
VCC	A10	Power/Other	
VSS	A11	Power/Other	
VCC	A12	Power/Other	
VCC	A13	Power/Other	
VSS	A14	Power/Other	
VCC	A15	Power/Other	
VSS	A16	Power/Other	
VCC	A17	Power/Other	
VCC	A18	Power/Other	
VSS	A19	Power/Other	
VCC	A20	Power/Other	
BCLK[1]	A21	Bus Clock	Input
BCLK[0]	A22	Bus Clock	Input
VSS	A23	Power/Other	
THRMDA	A24	Power/Other	
VSS	A25	Power/Other	
TEST6	A26	Test	
COMP[2]	AA1	Power/Other	Input/Output
VSS	AA2	Power/Other	
A[35]#	AA3	Source Synch	Input/Output
A[33]#	AA4	Source Synch	Input/Output
VSS	AA5	Power/Other	
TDI	AA6	CMOS	Input
VCC	AA7	Power/Other	
VSS	AA8	Power/Other	
VCC	AA9	Power/Other	
VCC	AA10	Power/Other	
VSS	AA11	Power/Other	
VCC	AA12	Power/Other	
VCC	AA13	Power/Other	
VSS	AA14	Power/Other	
VCC	AA15	Power/Other	

Table 20. Pin Listing by Pin Number (Sheet 3 of 17)

Pin Name	Pin Number	Signal Buffer Type	Direction
VSS	AA16	Power/Other	
VCC	AA17	Power/Other	
VCC	AA18	Power/Other	
VSS	AA19	Power/Other	
VCC	AA20	Power/Other	
D[50]#	AA21	Source Synch	Input/Output
VSS	AA22	Power/Other	
D[45]#	AA23	Source Synch	Input/Output
D[46]#	AA24	Source Synch	Input/Output
VSS	AA25	Power/Other	
DSTBP[2]#	AA26	Source Synch	Input/Output
VSS	AB1	Power/Other	
A[34]#	AB2	Source Synch	Input/Output
TDO	AB3	Open Drain	Output
VSS	AB4	Power/Other	
TMS	AB5	CMOS	Input
TRST#	AB6	CMOS	Input
VCC	AB7	Power/Other	
VSS	AB8	Power/Other	
VCC	AB9	Power/Other	
VCC	AB10	Power/Other	
VSS	AB11	Power/Other	
VCC	AB12	Power/Other	
VSS	AB13	Power/Other	
VCC	AB14	Power/Other	
VCC	AB15	Power/Other	
VSS	AB16	Power/Other	
VCC	AB17	Power/Other	
VCC	AB18	Power/Other	
VSS	AB19	Power/Other	
VCC	AB20	Power/Other	
D[52]#	AB21	Source Synch	Input/Output



Table 20. Pin Listing by Pin Number (Sheet 4 of 17)

Pin Name	Pin Number	Signal Buffer Type	Direction
D[51]#	AB22	Source Synch	Input/Output
VSS	AB23	Power/Other	
D[33]#	AB24	Source Synch	Input/Output
D[47]#	AB25	Source Synch	Input/Output
VSS	AB26	Power/Other	
PREQ#	AC1	Common Clock	Input
PRDY#	AC2	Common Clock	Output
VSS	AC3	Power/Other	
BPM[3]#	AC4	Common Clock	Input/Output
TCK	AC5	CMOS	Input
VSS	AC6	Power/Other	
VCC	AC7	Power/Other	
VSS	AC8	Power/Other	
VCC	AC9	Power/Other	
VCC	AC10	Power/Other	
VSS	AC11	Power/Other	
VCC	AC12	Power/Other	
VCC	AC13	Power/Other	
VSS	AC14	Power/Other	
VCC	AC15	Power/Other	
VSS	AC16	Power/Other	
VCC	AC17	Power/Other	
VCC	AC18	Power/Other	
VSS	AC19	Power/Other	
DINV[3]#	AC20	Source Synch	Input/Output
VSS	AC21	Power/Other	
D[60]#	AC22	Source Synch	Input/Output
D[63]#	AC23	Source Synch	Input/Output
VSS	AC24	Power/Other	
D[57]#	AC25	Source Synch	Input/Output

Table 20. Pin Listing by Pin Number (Sheet 5 of 17)

Pin Name	Pin Number	Signal Buffer Type	Direction
D[53]#	AC26	Source Synch	Input/Output
BPM[2]#	AD1	Common Clock	Output
VSS	AD2	Power/Other	
BPM[1]#	AD3	Common Clock	Output
BPM[0]#	AD4	Common Clock	Input/Output
VSS	AD5	Power/Other	
VID[0]	AD6	CMOS	Output
VCC	AD7	Power/Other	
VSS	AD8	Power/Other	
VCC	AD9	Power/Other	
VCC	AD10	Power/Other	
VSS	AD11	Power/Other	
VCC	AD12	Power/Other	
VSS	AD13	Power/Other	
VCC	AD14	Power/Other	
VCC	AD15	Power/Other	
VSS	AD16	Power/Other	
VCC	AD17	Power/Other	
VCC	AD18	Power/Other	
VSS	AD19	Power/Other	
D[54]#	AD20	Source Synch	Input/Output
D[59]#	AD21	Source Synch	Input/Output
VSS	AD22	Power/Other	
D[61]#	AD23	Source Synch	Input/Output
D[49]#	AD24	Source Synch	Input/Output
VSS	AD25	Power/Other	
GTLREF	AD26	Power/Other	Input
VSS	AE1	Power/Other	
VID[6]	AE2	CMOS	Output
VID[4]	AE3	CMOS	Output
VSS	AE4	Power/Other	



Table 20. Pin Listing by Pin Number (Sheet 6 of 17)

Pin Name	Pin Number	Signal Buffer Type	Direction
VID[2]	AE5	CMOS	Output
PSI#	AE6	CMOS	Output
VSSSENSE	AE7	Power/Other	Output
VSS	AE8	Power/Other	
VCC	AE9	Power/Other	
VCC	AE10	Power/Other	
VSS	AE11	Power/Other	
VCC	AE12	Power/Other	
VCC	AE13	Power/Other	
VSS	AE14	Power/Other	
VCC	AE15	Power/Other	
VSS	AE16	Power/Other	
VCC	AE17	Power/Other	
VCC	AE18	Power/Other	
VSS	AE19	Power/Other	
VCC	AE20	Power/Other	
D[58]#	AE21	Source Synch	Input/Output
D[55]#	AE22	Source Synch	Input/Output
VSS	AE23	Power/Other	
D[48]#	AE24	Source Synch	Input/Output
DSTBN[3]#	AE25	Source Synch	Input/Output
VSS	AE26	Power/Other	
TEST5	AF1	Test	
VSS	AF2	Power/Other	
VID[5]	AF3	CMOS	Output
VID[3]	AF4	CMOS	Output
VID[1]	AF5	CMOS	Output
VSS	AF6	Power/Other	
VCCSENSE	AF7	Power/Other	
VSS	AF8	Power/Other	
VCC	AF9	Power/Other	
VCC	AF10	Power/Other	
VSS	AF11	Power/Other	
VCC	AF12	Power/Other	

Table 20. Pin Listing by Pin Number (Sheet 7 of 17)

Pin Name	Pin Number	Signal Buffer Type	Direction
VSS	AF13	Power/Other	
VCC	AF14	Power/Other	
VCC	AF15	Power/Other	
VSS	AF16	Power/Other	
VCC	AF17	Power/Other	
VCC	AF18	Power/Other	
VSS	AF19	Power/Other	
VCC	AF20	Power/Other	
VSS	AF21	Power/Other	
D[62]#	AF22	Source Synch	Input/Output
D[56]#	AF23	Source Synch	Input/Output
DSTBP[3]#	AF24	Source Synch	Input/Output
VSS	AF25	Power/Other	
TEST4	AF26	Test	
RSVD	B2	Reserved	
INIT#	B3	CMOS	Input
LINT1	B4	CMOS	Input
DPSLP#	B5	CMOS	Input
VSS	B6	Power/Other	
VCC	B7	Power/Other	
VSS	B8	Power/Other	
VCC	B9	Power/Other	
VCC	B10	Power/Other	
VSS	B11	Power/Other	
VCC	B12	Power/Other	
VSS	B13	Power/Other	
VCC	B14	Power/Other	
VCC	B15	Power/Other	
VSS	B16	Power/Other	
VCC	B17	Power/Other	
VCC	B18	Power/Other	
VSS	B19	Power/Other	
VCC	B20	Power/Other	
VSS	B21	Power/Other	



Table 20. Pin Listing by Pin Number (Sheet 8 of 17)

Pin Name	Pin Number	Signal Buffer Type	Direction
BSEL[0]	B22	CMOS	Output
BSEL[1]	B23	CMOS	Output
VSS	B24	Power/Other	
THRMDC	B25	Power/Other	
VCCA	B26	Power/Other	
RESET#	C1	Common Clock	Input
VSS	C2	Power/Other	
RSVD	C3	Reserved	
IGNNE#	C4	CMOS	Input
VSS	C5	Power/Other	
LINT0	C6	CMOS	Input
THERMTRIP #	C7	Open Drain	Output
VSS	C8	Power/Other	
VCC	C9	Power/Other	
VCC	C10	Power/Other	
VSS	C11	Power/Other	
VCC	C12	Power/Other	
VCC	C13	Power/Other	
VSS	C14	Power/Other	
VCC	C15	Power/Other	
VSS	C16	Power/Other	
VCC	C17	Power/Other	
VCC	C18	Power/Other	
VSS	C19	Power/Other	
DBR#	C20	CMOS	Output
BSEL[2]	C21	CMOS	Output
VSS	C22	Power/Other	
TEST1	C23	Test	
TEST3	C24	Test	
VSS	C25	Power/Other	
VCCA	C26	Power/Other	
VSS	D1	Power/Other	
RSVD	D2	Reserved	
RSVD	D3	Reserved	
VSS	D4	Power/Other	

Table 20. Pin Listing by Pin Number (Sheet 9 of 17)

Pin Name	Pin Number	Signal Buffer Type	Direction
STPCLK#	D5	CMOS	Input
PWRGOOD	D6	CMOS	Input
SLP#	D7	CMOS	Input
VSS	D8	Power/Other	
VCC	D9	Power/Other	
VCC	D10	Power/Other	
VSS	D11	Power/Other	
VCC	D12	Power/Other	
VSS	D13	Power/Other	
VCC	D14	Power/Other	
VCC	D15	Power/Other	
VSS	D16	Power/Other	
VCC	D17	Power/Other	
VCC	D18	Power/Other	
VSS	D19	Power/Other	
IERR#	D20	Open Drain	Output
PROCHOT#	D21	Open Drain	Input/Output
RSVD	D22	Reserved	
VSS	D23	Power/Other	
DPWR#	D24	Common Clock	Input/Output
TEST2	D25	Test	
VSS	D26	Power/Other	
DBSY#	E1	Common Clock	Input/Output
BNR#	E2	Common Clock	Input/Output
VSS	E3	Power/Other	
HITM#	E4	Common Clock	Input/Output
DPRSTP#	E5	CMOS	Input
VSS	E6	Power/Other	
VCC	E7	Power/Other	
VSS	E8	Power/Other	
VCC	E9	Power/Other	
VCC	E10	Power/Other	
VSS	E11	Power/Other	



Table 20. Pin Listing by Pin Number (Sheet 10 of 17)

Pin Name	Pin Number	Signal Buffer Type	Direction
VCC	E12	Power/Other	
VCC	E13	Power/Other	
VSS	E14	Power/Other	
VCC	E15	Power/Other	
VSS	E16	Power/Other	
VCC	E17	Power/Other	
VCC	E18	Power/Other	
VSS	E19	Power/Other	
VCC	E20	Power/Other	
VSS	E21	Power/Other	
D[0]#	E22	Source Synch	Input/Output
D[7]#	E23	Source Synch	Input/Output
VSS	E24	Power/Other	
D[6]#	E25	Source Synch	Input/Output
D[2]#	E26	Source Synch	Input/Output
BR0#	F1	Common Clock	Input/Output
VSS	F2	Power/Other	
RS[0]#	F3	Common Clock	Input
RS[1]#	F4	Common Clock	Input
VSS	F5	Power/Other	
RSVD	F6	Reserved	
VCC	F7	Power/Other	
VSS	F8	Power/Other	
VCC	F9	Power/Other	
VCC	F10	Power/Other	
VSS	F11	Power/Other	
VCC	F12	Power/Other	
VSS	F13	Power/Other	
VCC	F14	Power/Other	
VCC	F15	Power/Other	
VSS	F16	Power/Other	
VCC	F17	Power/Other	

Table 20. Pin Listing by Pin Number (Sheet 11 of 17)

Pin Name	Pin Number	Signal Buffer Type	Direction
VCC	F18	Power/Other	
VSS	F19	Power/Other	
VCC	F20	Power/Other	
DRDY#	F21	Common Clock	Input/Output
VSS	F22	Power/Other	
D[4]#	F23	Source Synch	Input/Output
D[1]#	F24	Source Synch	Input/Output
VSS	F25	Power/Other	
D[13]#	F26	Source Synch	Input/Output
VSS	G1	Power/Other	
TRDY#	G2	Common Clock	Input
RS[2]#	G3	Common Clock	Input
VSS	G4	Power/Other	
BPRI#	G5	Common Clock	Input
HIT#	G6	Common Clock	Input/Output
VCCP	G21	Power/Other	
D[3]#	G22	Source Synch	Input/Output
VSS	G23	Power/Other	
D[9]#	G24	Source Synch	Input/Output
D[5]#	G25	Source Synch	Input/Output
VSS	G26	Power/Other	
ADS#	H1	Common Clock	Input/Output
REQ[1]#	H2	Source Synch	Input/Output
VSS	H3	Power/Other	
LOCK#	H4	Common Clock	Input/Output
DEFER#	H5	Common Clock	Input



Table 20. Pin Listing by Pin Number (Sheet 12 of 17)

Pin Name	Pin Number	Signal Buffer Type	Direction
VSS	H6	Power/Other	
VSS	H21	Power/Other	
D[12]#	H22	Source Synch	Input/Output
D[15]#	H23	Source Synch	Input/Output
VSS	H24	Power/Other	
DINV[0]#	H25	Source Synch	Input/Output
DSTBP[0]#	H26	Source Synch	Input/Output
A[9]#	J1	Source Synch	Input/Output
VSS	J2	Power/Other	
REQ[3]#	J3	Source Synch	Input/Output
A[3]#	J4	Source Synch	Input/Output
VSS	J5	Power/Other	
VCCP	J6	Power/Other	
VCCP	J21	Power/Other	
VSS	J22	Power/Other	
D[11]#	J23	Source Synch	Input/Output
D[10]#	J24	Source Synch	Input/Output
VSS	J25	Power/Other	
DSTBN[0]#	J26	Source Synch	Input/Output
VSS	K1	Power/Other	
REQ[2]#	K2	Source Synch	Input/Output
REQ[0]#	K3	Source Synch	Input/Output
VSS	K4	Power/Other	
A[6]#	K5	Source Synch	Input/Output
VCCP	K6	Power/Other	
VCCP	K21	Power/Other	
D[14]#	K22	Source Synch	Input/Output

Table 20. Pin Listing by Pin Number (Sheet 13 of 17)

Pin Name	Pin Number	Signal Buffer Type	Direction
VSS	K23	Power/Other	
D[8]#	K24	Source Synch	Input/Output
D[17]#	K25	Source Synch	Input/Output
VSS	K26	Power/Other	
REQ[4]#	L1	Source Synch	Input/Output
A[13]#	L2	Source Synch	Input/Output
VSS	L3	Power/Other	
A[5]#	L4	Source Synch	Input/Output
A[4]#	L5	Source Synch	Input/Output
VSS	L6	Power/Other	
VSS	L21	Power/Other	
D[22]#	L22	Source Synch	Input/Output
D[20]#	L23	Source Synch	Input/Output
VSS	L24	Power/Other	
D[29]#	L25	Source Synch	Input/Output
DSTBN[1]#	L26	Source Synch	Input/Output
ADSTB[0]#	M1	Source Synch	Input/Output
VSS	M2	Power/Other	
A[7]#	M3	Source Synch	Input/Output
RSVD	M4	Reserved	
VSS	M5	Power/Other	
VCCP	M6	Power/Other	
VCCP	M21	Power/Other	
VSS	M22	Power/Other	
D[23]#	M23	Source Synch	Input/Output
D[21]#	M24	Source Synch	Input/Output
VSS	M25	Power/Other	



Table 20. Pin Listing by Pin Number (Sheet 14 of 17)

Pin Name	Pin Number	Signal Buffer Type	Direction
DSTBP[1]#	M26	Source Synch	Input/Output
VSS	N1	Power/Other	
A[8]#	N2	Source Synch	Input/Output
A[10]#	N3	Source Synch	Input/Output
VSS	N4	Power/Other	
RSVD	N5	Reserved	
VCCP	N6	Power/Other	
VCCP	N21	Power/Other	
D[16]#	N22	Source Synch	Input/Output
VSS	N23	Power/Other	
DINV[1]#	N24	Source Synch	Input/Output
D[31]#	N25	Source Synch	Input/Output
VSS	N26	Power/Other	
A[15]#	P1	Source Synch	Input/Output
A[12]#	P2	Source Synch	Input/Output
VSS	P3	Power/Other	
A[14]#	P4	Source Synch	Input/Output
A[11]#	P5	Source Synch	Input/Output
VSS	P6	Power/Other	
VSS	P21	Power/Other	
D[26]#	P22	Source Synch	Input/Output
D[25]#	P23	Source Synch	Input/Output
VSS	P24	Power/Other	
D[24]#	P25	Source Synch	Input/Output
D[18]#	P26	Source Synch	Input/Output
A[16]#	R1	Source Synch	Input/Output

Table 20. Pin Listing by Pin Number (Sheet 15 of 17)

Pin Name	Pin Number	Signal Buffer Type	Direction
VSS	R2	Power/Other	
A[19]#	R3	Source Synch	Input/Output
A[24]#	R4	Source Synch	Input/Output
VSS	R5	Power/Other	
VCCP	R6	Power/Other	
VCCP	R21	Power/Other	
VSS	R22	Power/Other	
D[19]#	R23	Source Synch	Input/Output
D[28]#	R24	Source Synch	Input/Output
VSS	R25	Power/Other	
COMP[0]	R26	Power/Other	Input/Output
VSS	T1	Power/Other	
RSVD	T2	Reserved	
A[26]#	T3	Source Synch	Input/Output
VSS	T4	Power/Other	
A[25]#	T5	Source Synch	Input/Output
VCCP	T6	Power/Other	
VCCP	T21	Power/Other	
D[37]#	T22	Source Synch	Input/Output
VSS	T23	Power/Other	
D[27]#	T24	Source Synch	Input/Output
D[30]#	T25	Source Synch	Input/Output
VSS	T26	Power/Other	
A[23]#	U1	Source Synch	Input/Output
A[30]#	U2	Source Synch	Input/Output
VSS	U3	Power/Other	
A[21]#	U4	Source Synch	Input/Output



Table 20. Pin Listing by Pin Number (Sheet 16 of 17)

Pin Name	Pin Number	Signal Buffer Type	Direction
A[18]#	U5	Source Synch	Input/Output
VSS	U6	Power/Other	
VSS	U21	Power/Other	
DINV[2]#	U22	Source Synch	Input/Output
D[39]#	U23	Source Synch	Input/Output
VSS	U24	Power/Other	
D[38]#	U25	Source Synch	Input/Output
COMP[1]	U26	Power/Other	Input/Output
ADSTB[1]#	V1	Source Synch	Input/Output
VSS	V2	Power/Other	
RSVD	V3	Reserved	
A[31]#	V4	Source Synch	Input/Output
VSS	V5	Power/Other	
VCCP	V6	Power/Other	
VCCP	V21	Power/Other	
VSS	V22	Power/Other	
D[36]#	V23	Source Synch	Input/Output
D[34]#	V24	Source Synch	Input/Output
VSS	V25	Power/Other	
D[35]#	V26	Source Synch	Input/Output
VSS	W1	Power/Other	
A[27]#	W2	Source Synch	Input/Output
A[32]#	W3	Source Synch	Input/Output
VSS	W4	Power/Other	
A[28]#	W5	Source Synch	Input/Output
A[20]#	W6	Source Synch	Input/Output
VCCP	W21	Power/Other	

Table 20. Pin Listing by Pin Number (Sheet 17 of 17)

Pin Name	Pin Number	Signal Buffer Type	Direction
D[41]#	W22	Source Synch	Input/Output
VSS	W23	Power/Other	
D[43]#	W24	Source Synch	Input/Output
D[44]#	W25	Source Synch	Input/Output
VSS	W26	Power/Other	
COMP[3]	Y1	Power/Other	Input/Output
A[17]#	Y2	Source Synch	Input/Output
VSS	Y3	Power/Other	
A[29]#	Y4	Source Synch	Input/Output
A[22]#	Y5	Source Synch	Input/Output
VSS	Y6	Power/Other	
VSS	Y21	Power/Other	
D[32]#	Y22	Source Synch	Input/Output
D[42]#	Y23	Source Synch	Input/Output
VSS	Y24	Power/Other	
D[40]#	Y25	Source Synch	Input/Output
DSTBN[2]#	Y26	Source Synch	Input/Output



Table 21. SFF Listing by Ball Name

Signal Name	Ball Number
A[3]#	P2
A[4]#	V4
A[5]#	W1
A[6]#	T4
A[7]#	AA1
A[8]#	AB4
A[9]#	T2
A[10]#	AC5
A[11]#	AD2
A[12]#	AD4
A[13]#	AA5
A[14]#	AE5
A[15]#	AB2
A[16]#	AC1
A[17]#	AN1
A[18]#	AK4
A[19]#	AG1
A[20]#	AT4
A[21]#	AK2
A[22]#	AT2
A[23]#	AH2
A[24]#	AF4
A[25]#	AJ5
A[26]#	AH4
A[27]#	AM4
A[28]#	AP4
A[29]#	AR5
A[30]#	AJ1
A[31]#	AL1
A[32]#	AM2
A[33]#	AU5
A[34]#	AP2
A[35]#	AR1
A20M#	C7
ADS#	M4
ADSTB[0]#	Y4

Signal Name	Ball Number
ADSTB[1]#	AN5
BCLK[0]	A35
BCLK[1]	C35
BNR#	J5
BPM[0]#	AY8
BPM[1]#	BA7
BPM[2]#	BA5
BPM[3]#	AY2
BPRI#	L5
BR0#	M2
BSEL[0]	A37
BSEL[1]	C37
BSEL[2]	B38
COMP[0]	AE43
COMP[1]	AD44
COMP[2]	AE1
COMP[3]	AF2
D[0]#	F40
D[1]#	G43
D[2]#	E43
D[3]#	J43
D[4]#	H40
D[5]#	H44
D[6]#	G39
D[7]#	E41
D[8]#	L41
D[9]#	K44
D[10]#	N41
D[11]#	T40
D[12]#	M40
D[13]#	G41
D[14]#	M44
D[15]#	L43
D[16]#	P44
D[17]#	V40
D[18]#	V44
D[19]#	AB44



Package Mechanical Specifications and Pin Information

Signal Name	Ball Number
D[20]#	R41
D[21]#	W41
D[22]#	N43
D[23]#	U41
D[24]#	AA41
D[25]#	AB40
D[26]#	AD40
D[27]#	AC41
D[28]#	AA43
D[29]#	Y40
D[30]#	Y44
D[31]#	T44
D[32]#	AP44
D[33]#	AR43
D[34]#	AH40
D[35]#	AF40
D[36]#	AJ43
D[37]#	AG41
D[38]#	AF44
D[39]#	AH44
D[40]#	AM44
D[41]#	AN43
D[42]#	AM40
D[43]#	AK40
D[44]#	AG43
D[45]#	AP40
D[46]#	AN41
D[47]#	AL41
D[48]#	AV38
D[49]#	AT44
D[50]#	AV40
D[51]#	AU41
D[52]#	AW41
D[53]#	AR41
D[54]#	BA37
D[55]#	BB38
D[56]#	AY36
D[57]#	AT40

Signal Name	Ball Number
D[58]#	BC35
D[59]#	BC39
D[60]#	BA41
D[61]#	BB40
D[62]#	BA35
D[63]#	AU43
DBR#	J7
DBSY#	J1
DEFER#	N5
DINV[0]#	P40
DINV[1]#	R43
DINV[2]#	AJ41
DINV[3]#	BC37
DPRSTP#	G7
DPSLP#	B8
DPWR#	C41
DRDY#	F38
DSTBN[0]#	K40
DSTBN[1]#	U43
DSTBN[2]#	AK44
DSTBN[3]#	AY40
DSTBP[0]#	J41
DSTBP[1]#	W43
DSTBP[2]#	AL43
DSTBP[3]#	AY38
FERR#	D4
GTLREF	AW43
HIT#	H2
HITM#	F2
IERR#	B40
IGNNE#	F10
INIT#	D8
LINT0	C9
LINT1	C5
LOCK#	N1
PRDY#	AV10
PREQ#	AV2
PROCHOT#	D38



Signal Name	Ball Number
PSI#	BD10
PWRGOOD	E7
REQ[0]#	R1
REQ[1]#	R5
REQ[2]#	U1
REQ[3]#	P4
REQ[4]#	W5
RESET#	G5
RS[0]#	K2
RS[1]#	H4
RS[2]#	K4
RSVD01	V2
RSVD02	Y2
RSVD03	AG5
RSVD04	AL5
RSVD05	J9
RSVD06	F4
RSVD07	H8
SLP#	D10
SMI#	E5
STPCLK#	F8
TCK	AV4
TDI	AW7
TDO	AU1
TEST1	E37
TEST2	D40
TEST3	C43
TEST4	AE41
TEST5	AY10
TEST6	AC43
THERMTRIP#	B10
THRMDA	BB34
THRMDC	BD34
TMS	AW5
TRDY#	L1
TRST#	AV8
VCC	AA33
VCC	AB16

Signal Name	Ball Number
VCC	AB18
VCC	AB20
VCC	AB22
VCC	AB24
VCC	AB26
VCC	AB28
VCC	AB30
VCC	AB32
VCC	AC33
VCC	AD16
VCC	AD18
VCC	AD20
VCC	AD22
VCC	AD24
VCC	AD26
VCC	AD28
VCC	AD30
VCC	AD32
VCC	AE33
VCC	AF16
VCC	AF18
VCC	AF20
VCC	AF22
VCC	AF24
VCC	AF26
VCC	AF28
VCC	AF30
VCC	AF32
VCC	AG33
VCC	AH16
VCC	AH18
VCC	AH20
VCC	AH22
VCC	AH24
VCC	AH26
VCC	AH28
VCC	AH30
VCC	AH32



Package Mechanical Specifications and Pin Information

Signal Name	Ball Number
VCC	AJ33
VCC	AK16
VCC	AK18
VCC	AK20
VCC	AK22
VCC	AK24
VCC	AK26
VCC	AK28
VCC	AK30
VCC	AK32
VCC	AL33
VCC	AM14
VCC	AM16
VCC	AM18
VCC	AM20
VCC	AM22
VCC	AM24
VCC	AM26
VCC	AM28
VCC	AM30
VCC	AM32
VCC	AN33
VCC	AP14
VCC	AP16
VCC	AP18
VCC	AP20
VCC	AP22
VCC	AP24
VCC	AP26
VCC	AP28
VCC	AP30
VCC	AP32
VCC	AR33
VCC	AT14
VCC	AT16
VCC	AT18
VCC	AT20
VCC	AT22

Signal Name	Ball Number
VCC	AT24
VCC	AT26
VCC	AT28
VCC	AT30
VCC	AT32
VCC	AT34
VCC	AU33
VCC	AV14
VCC	AV16
VCC	AV18
VCC	AV20
VCC	AV22
VCC	AV24
VCC	AV26
VCC	AV28
VCC	AV30
VCC	AV32
VCC	AY14
VCC	AY16
VCC	AY18
VCC	AY20
VCC	AY22
VCC	AY24
VCC	AY26
VCC	AY28
VCC	AY30
VCC	AY32
VCC	B16
VCC	B18
VCC	B20
VCC	B22
VCC	B24
VCC	B26
VCC	B28
VCC	B30
VCC	BB14
VCC	BB16
VCC	BB18



Signal Name	Ball Number
VCC	BB20
VCC	BB22
VCC	BB24
VCC	BB26
VCC	BB28
VCC	BB30
VCC	BB32
VCC	BD14
VCC	BD16
VCC	BD18
VCC	BD20
VCC	BD22
VCC	BD24
VCC	BD26
VCC	BD28
VCC	BD30
VCC	BD32
VCC	D16
VCC	D18
VCC	D20
VCC	D22
VCC	D24
VCC	D26
VCC	D28
VCC	D30
VCC	F16
VCC	F18
VCC	F20
VCC	F22
VCC	F24
VCC	F26
VCC	F28
VCC	F30
VCC	F32
VCC	G33
VCC	H16
VCC	H18
VCC	H20

Signal Name	Ball Number
VCC	H22
VCC	H24
VCC	H26
VCC	H28
VCC	H30
VCC	H32
VCC	J33
VCC	K16
VCC	K18
VCC	K20
VCC	K22
VCC	K24
VCC	K26
VCC	K28
VCC	K30
VCC	K32
VCC	L33
VCC	M16
VCC	M18
VCC	M20
VCC	M22
VCC	M24
VCC	M26
VCC	M28
VCC	M30
VCC	M32
VCC	N33
VCC	P16
VCC	P18
VCC	P20
VCC	P22
VCC	P24
VCC	P26
VCC	P28
VCC	P30
VCC	P32
VCC	R33
VCC	T16



Package Mechanical Specifications and Pin Information

Signal Name	Ball Number
VCC	T18
VCC	T20
VCC	T22
VCC	T24
VCC	T26
VCC	T28
VCC	T30
VCC	T32
VCC	U33
VCC	V16
VCC	V18
VCC	V20
VCC	V22
VCC	V24
VCC	V26
VCC	V28
VCC	V30
VCC	V32
VCC	W33
VCC	Y16
VCC	Y18
VCC	Y20
VCC	Y22
VCC	Y24
VCC	Y26
VCC	Y28
VCC	Y30
VCC	Y32
VCCA	B34
VCCA	D34
VCCP	A13
VCCP	A33
VCCP	AA7
VCCP	AA9
VCCP	AA11
VCCP	AA13
VCCP	AA35
VCCP	AA37

Signal Name	Ball Number
VCCP	AB10
VCCP	AB12
VCCP	AB14
VCCP	AB36
VCCP	AB38
VCCP	AC7
VCCP	AC9
VCCP	AC11
VCCP	AC13
VCCP	AC35
VCCP	AC37
VCCP	AD14
VCCP	AE7
VCCP	AE9
VCCP	AE11
VCCP	AE13
VCCP	AE35
VCCP	AE37
VCCP	AF10
VCCP	AF12
VCCP	AF14
VCCP	AF36
VCCP	AF38
VCCP	AG7
VCCP	AG9
VCCP	AG11
VCCP	AG13
VCCP	AG35
VCCP	AG37
VCCP	AH14
VCCP	AJ7
VCCP	AJ9
VCCP	AJ11
VCCP	AJ13
VCCP	AJ35
VCCP	AJ37
VCCP	AK10
VCCP	AK12



Signal Name	Ball Number
VCCP	AK14
VCCP	AK36
VCCP	AK38
VCCP	AL7
VCCP	AL9
VCCP	AL11
VCCP	AL13
VCCP	AL35
VCCP	AL37
VCCP	AN7
VCCP	AN9
VCCP	AN11
VCCP	AN13
VCCP	AN35
VCCP	AN37
VCCP	AP10
VCCP	AP12
VCCP	AP36
VCCP	AP38
VCCP	AR7
VCCP	AR9
VCCP	AR11
VCCP	AR13
VCCP	AU11
VCCP	AU13
VCCP	B12
VCCP	B14
VCCP	B32
VCCP	C13
VCCP	C33
VCCP	D12
VCCP	D14
VCCP	D32
VCCP	E11
VCCP	E13
VCCP	E33
VCCP	E35
VCCP	F12

Signal Name	Ball Number
VCCP	F14
VCCP	F34
VCCP	F36
VCCP	G11
VCCP	G13
VCCP	G35
VCCP	H12
VCCP	H14
VCCP	H36
VCCP	J11
VCCP	J13
VCCP	J35
VCCP	J37
VCCP	K10
VCCP	K12
VCCP	K14
VCCP	K36
VCCP	K38
VCCP	L7
VCCP	L9
VCCP	L11
VCCP	L13
VCCP	L35
VCCP	L37
VCCP	M14
VCCP	N7
VCCP	N9
VCCP	N11
VCCP	N13
VCCP	N35
VCCP	N37
VCCP	P10
VCCP	P12
VCCP	P14
VCCP	P36
VCCP	P38
VCCP	R7
VCCP	R9



Package Mechanical Specifications and Pin Information

Signal Name	Ball Number
VCCP	R11
VCCP	R13
VCCP	R35
VCCP	R37
VCCP	T14
VCCP	U7
VCCP	U9
VCCP	U11
VCCP	U13
VCCP	U35
VCCP	U37
VCCP	V10
VCCP	V12
VCCP	V14
VCCP	V36
VCCP	V38
VCCP	W7
VCCP	W9
VCCP	W11
VCCP	W13
VCCP	W35
VCCP	W37
VCCP	Y14
VCCSENSE	BD12
VID[0]	BD8
VID[1]	BC7
VID[2]	BB10
VID[3]	BB8
VID[4]	BC5
VID[5]	BB4
VID[6]	AY4
VSS	A5
VSS	A7
VSS	A9
VSS	A11
VSS	A15
VSS	A17
VSS	A19

Signal Name	Ball Number
VSS	A21
VSS	A23
VSS	A25
VSS	A27
VSS	A29
VSS	A31
VSS	A39
VSS	A41
VSS	AA3
VSS	AA15
VSS	AA17
VSS	AA19
VSS	AA21
VSS	AA23
VSS	AA25
VSS	AA27
VSS	AA29
VSS	AA31
VSS	AA39
VSS	AB6
VSS	AB8
VSS	AB34
VSS	AB42
VSS	AC3
VSS	AC15
VSS	AC17
VSS	AC19
VSS	AC21
VSS	AC23
VSS	AC25
VSS	AC27
VSS	AC29
VSS	AC31
VSS	AC39
VSS	AD6
VSS	AD8
VSS	AD10
VSS	AD12



Signal Name	Ball Number
VSS	AD34
VSS	AD36
VSS	AD38
VSS	AD42
VSS	AE3
VSS	AE15
VSS	AE17
VSS	AE19
VSS	AE21
VSS	AE23
VSS	AE25
VSS	AE27
VSS	AE29
VSS	AE31
VSS	AE39
VSS	AF6
VSS	AF8
VSS	AF34
VSS	AF42
VSS	AG3
VSS	AG15
VSS	AG17
VSS	AG19
VSS	AG21
VSS	AG23
VSS	AG25
VSS	AG27
VSS	AG29
VSS	AG31
VSS	AG39
VSS	AH6
VSS	AH8
VSS	AH10
VSS	AH12
VSS	AH34
VSS	AH36
VSS	AH38
VSS	AH42

Signal Name	Ball Number
VSS	AJ3
VSS	AJ15
VSS	AJ17
VSS	AJ19
VSS	AJ21
VSS	AJ23
VSS	AJ25
VSS	AJ27
VSS	AJ29
VSS	AJ31
VSS	AJ39
VSS	AK6
VSS	AK8
VSS	AK34
VSS	AK42
VSS	AL3
VSS	AL15
VSS	AL17
VSS	AL19
VSS	AL21
VSS	AL23
VSS	AL25
VSS	AL27
VSS	AL29
VSS	AL31
VSS	AL39
VSS	AM6
VSS	AM8
VSS	AM10
VSS	AM12
VSS	AM34
VSS	AM36
VSS	AM38
VSS	AM42
VSS	AN3
VSS	AN15
VSS	AN17
VSS	AN19



Package Mechanical Specifications and Pin Information

Signal Name	Ball Number
VSS	AN21
VSS	AN23
VSS	AN25
VSS	AN27
VSS	AN29
VSS	AN31
VSS	AN39
VSS	AP6
VSS	AP8
VSS	AP34
VSS	AP42
VSS	AR3
VSS	AR15
VSS	AR17
VSS	AR19
VSS	AR21
VSS	AR23
VSS	AR25
VSS	AR27
VSS	AR29
VSS	AR31
VSS	AR35
VSS	AR37
VSS	AR39
VSS	AT6
VSS	AT8
VSS	AT10
VSS	AT12
VSS	AT36
VSS	AT38
VSS	AT42
VSS	AU3
VSS	AU7
VSS	AU9
VSS	AU15
VSS	AU17
VSS	AU19
VSS	AU21

Signal Name	Ball Number
VSS	AU23
VSS	AU25
VSS	AU27
VSS	AU29
VSS	AU31
VSS	AU35
VSS	AU37
VSS	AU39
VSS	AV6
VSS	AV12
VSS	AV34
VSS	AV36
VSS	AV42
VSS	AV44
VSS	AW1
VSS	AW3
VSS	AW9
VSS	AW11
VSS	AW13
VSS	AW15
VSS	AW17
VSS	AW19
VSS	AW21
VSS	AW23
VSS	AW25
VSS	AW27
VSS	AW29
VSS	AW31
VSS	AW33
VSS	AW35
VSS	AW37
VSS	AW39
VSS	AY6
VSS	AY12
VSS	AY34
VSS	AY42
VSS	AY44
VSS	B4



Signal Name	Ball Number
VSS	B6
VSS	B36
VSS	B42
VSS	BA1
VSS	BA3
VSS	BA9
VSS	BA11
VSS	BA13
VSS	BA15
VSS	BA17
VSS	BA19
VSS	BA21
VSS	BA23
VSS	BA25
VSS	BA27
VSS	BA29
VSS	BA31
VSS	BA33
VSS	BA39
VSS	BA43
VSS	BB2
VSS	BB6
VSS	BB12
VSS	BB36
VSS	BB42
VSS	BC3
VSS	BC9
VSS	BC11
VSS	BC15
VSS	BC17
VSS	BC19
VSS	BC21
VSS	BC23
VSS	BC25
VSS	BC27
VSS	BC29
VSS	BC31
VSS	BC33

Signal Name	Ball Number
VSS	BC41
VSS	BD4
VSS	BD6
VSS	BD36
VSS	BD38
VSS	BD40
VSS	C3
VSS	C11
VSS	C15
VSS	C17
VSS	C19
VSS	C21
VSS	C23
VSS	C25
VSS	C27
VSS	C29
VSS	C31
VSS	C39
VSS	D2
VSS	D6
VSS	D36
VSS	D42
VSS	D44
VSS	E1
VSS	E3
VSS	E9
VSS	E15
VSS	E17
VSS	E19
VSS	E21
VSS	E23
VSS	E25
VSS	E27
VSS	E29
VSS	E31
VSS	E39
VSS	F6
VSS	F42



Package Mechanical Specifications and Pin Information

Signal Name	Ball Number
VSS	F44
VSS	G1
VSS	G3
VSS	G9
VSS	G15
VSS	G17
VSS	G19
VSS	G21
VSS	G23
VSS	G25
VSS	G27
VSS	G29
VSS	G31
VSS	G37
VSS	H6
VSS	H10
VSS	H34
VSS	H38
VSS	H42
VSS	J3
VSS	J15
VSS	J17
VSS	J19
VSS	J21
VSS	J23
VSS	J25
VSS	J27
VSS	J29
VSS	J31
VSS	J39
VSS	K6
VSS	K8
VSS	K34
VSS	K42
VSS	L3
VSS	L15
VSS	L17
VSS	L19

Signal Name	Ball Number
VSS	L21
VSS	L23
VSS	L25
VSS	L27
VSS	L29
VSS	L31
VSS	L39
VSS	M6
VSS	M8
VSS	M10
VSS	M12
VSS	M34
VSS	M36
VSS	M38
VSS	M42
VSS	N3
VSS	N15
VSS	N17
VSS	N19
VSS	N21
VSS	N23
VSS	N25
VSS	N27
VSS	N29
VSS	N31
VSS	N39
VSS	P6
VSS	P8
VSS	P34
VSS	P42
VSS	R3
VSS	R15
VSS	R17
VSS	R19
VSS	R21
VSS	R23
VSS	R25
VSS	R27



Signal Name	Ball Number
VSS	R29
VSS	R31
VSS	R39
VSS	T6
VSS	T8
VSS	T10
VSS	T12
VSS	T34
VSS	T36
VSS	T38
VSS	T42
VSS	U3
VSS	U5
VSS	U15
VSS	U17
VSS	U19
VSS	U21
VSS	U23
VSS	U25
VSS	U27
VSS	U29
VSS	U31
VSS	U39
VSS	V6
VSS	V8
VSS	V34
VSS	V42
VSS	W3
VSS	W15
VSS	W17
VSS	W19
VSS	W21
VSS	W23
VSS	W25
VSS	W27
VSS	W29
VSS	W31
VSS	W39

Signal Name	Ball Number
VSS	Y6
VSS	Y8
VSS	Y10
VSS	Y12
VSS	Y34
VSS	Y36
VSS	Y38
VSS	Y42
VSSSENSE	BC13



Package Mechanical Specifications and Pin Information



4.3 Alphabetical Signals Reference

Table 22. Signal Description (Sheet 1 of 7)

Name	Type	Description						
A[35:3]#	Input/Output	A[35:3]# (Address) define a 2 ³⁶ -byte physical memory address space. In sub-phase 1 of the address phase, these pins transmit the address of a transaction. In sub-phase 2, these pins transmit transaction type information. These signals must connect the appropriate pins of both agents on the processor FSB. A[35:3]# are source synchronous signals and are latched into the receiving buffers by ADSTB[1:0]#. Address signals are used as straps which are sampled before RESET# is deasserted.						
A20M#	Input	If A20M# (Address-20 Mask) is asserted, the processor masks physical address bit 20 (A20#) before looking up a line in any internal cache and before driving a read/write transaction on the bus. Asserting A20M# emulates the 8086 processor's address wrap-around at the 1-Mbyte boundary. Assertion of A20M# is only supported in real mode. A20M# is an asynchronous signal. However, to ensure recognition of this signal following an Input/Output write instruction, it must be valid along with the TRDY# assertion of the corresponding Input/Output Write bus transaction.						
ADS#	Input/Output	ADS# (Address Strobe) is asserted to indicate the validity of the transaction address on the A[35:3]# and REQ[4:0]# pins. All bus agents observe the ADS# activation to begin parity checking, protocol checking, address decode, internal snoop, or deferred reply ID match operations associated with the new transaction.						
ADSTB[1:0]#	Input/Output	Address strobes are used to latch A[35:3]# and REQ[4:0]# on their rising and falling edges. Strobes are associated with signals as shown below. <table border="1" style="margin-left: 20px;"> <thead> <tr> <th>Signals</th> <th>Associated Strobe</th> </tr> </thead> <tbody> <tr> <td>REQ[4:0]#, A[16:3]#</td> <td>ADSTB[0]#</td> </tr> <tr> <td>A[35:17]#</td> <td>ADSTB[1]#</td> </tr> </tbody> </table>	Signals	Associated Strobe	REQ[4:0]#, A[16:3]#	ADSTB[0]#	A[35:17]#	ADSTB[1]#
Signals	Associated Strobe							
REQ[4:0]#, A[16:3]#	ADSTB[0]#							
A[35:17]#	ADSTB[1]#							
BCLK[1:0]	Input	The differential pair BCLK (Bus Clock) determines the FSB frequency. All FSB agents must receive these signals to drive their outputs and latch their inputs. All external timing parameters are specified with respect to the rising edge of BCLK0 crossing V _{CROSS} .						
BNR#	Input/Output	BNR# (Block Next Request) is used to assert a bus stall by any bus agent who is unable to accept new bus transactions. During a bus stall, the current bus owner cannot issue any new transactions.						
BPM[2:1]# BPM[3,0]#	Output Input/Output	BPM[3:0]# (Breakpoint Monitor) are breakpoint and performance monitor signals. They are outputs from the processor which indicate the status of breakpoints and programmable counters used for monitoring processor performance. BPM[3:0]# should connect the appropriate pins of all processor FSB agents. This includes debug or performance monitoring tools.						
BPRI#	Input	BPRI# (Bus Priority Request) is used to arbitrate for ownership of the FSB. It must connect the appropriate pins of both FSB agents. Observing BPRI# active (as asserted by the priority agent) causes the other agent to stop issuing new requests, unless such requests are part of an ongoing locked operation. The priority agent keeps BPRI# asserted until all of its requests are completed, then releases the bus by deasserting BPRI#.						
BR0#	Input/Output	BR0# is used by the processor to request the bus. The arbitration is done between processor (Symmetric Agent) and (G)MCH (High Priority Agent).						



Table 22. Signal Description (Sheet 2 of 7)

Name	Type	Description															
BSEL[2:0]	Output	BSEL[2:0] (Bus Select) are used to select the processor input clock frequency. Table 3 defines the possible combinations of the signals and the frequency associated with each combination. The required frequency is determined by the processor, chipset and clock synthesizer. All agents must operate at the same frequency.															
COMP[3:0]	Analog	COMP[3:0] must be terminated on the system board using precision (1% tolerance) resistors.															
D[63:0]#	Input/Output	<p>D[63:0]# (Data) are the data signals. These signals provide a 64-bit data path between the FSB agents, and must connect the appropriate pins on both agents. The data driver asserts DRDY# to indicate a valid data transfer.</p> <p>D[63:0]# are quad-pumped signals and are driven four times in a common clock period. D[63:0]# are latched off the falling edge of both DSTBP[3:0]# and DSTBN[3:0]#. Each group of 16 data signals corresponds to a pair of one DSTBP# and one DSTBN#. The following table shows the grouping of data signals to data strobes and DINV#.</p> <p>Quad-Pumped Signal Groups</p> <table border="1"> <thead> <tr> <th>Data Group</th> <th>DSTBN#/ DSTBP#</th> <th>DINV#</th> </tr> </thead> <tbody> <tr> <td>D[15:0]#</td> <td>0</td> <td>0</td> </tr> <tr> <td>D[31:16]#</td> <td>1</td> <td>1</td> </tr> <tr> <td>D[47:32]#</td> <td>2</td> <td>2</td> </tr> <tr> <td>D[63:48]#</td> <td>3</td> <td>3</td> </tr> </tbody> </table> <p>Furthermore, the DINV# pins determine the polarity of the data signals. Each group of 16 data signals corresponds to one DINV# signal. When the DINV# signal is active, the corresponding data group is inverted and therefore sampled active high.</p>	Data Group	DSTBN#/ DSTBP#	DINV#	D[15:0]#	0	0	D[31:16]#	1	1	D[47:32]#	2	2	D[63:48]#	3	3
Data Group	DSTBN#/ DSTBP#	DINV#															
D[15:0]#	0	0															
D[31:16]#	1	1															
D[47:32]#	2	2															
D[63:48]#	3	3															
DBR#	Output	DBR# (Data Bus Reset) is used only in processor systems where no debug port is implemented on the system board. DBR# is used by a debug port interposer so that an in-target probe can drive system reset. If a debug port is implemented in the system, DBR# is a no-connect in the system. DBR# is not a processor signal.															
DBSY#	Input/Output	DBSY# (Data Bus Busy) is asserted by the agent responsible for driving data on the FSB to indicate that the data bus is in use. The data bus is released after DBSY# is deasserted. This signal must connect the appropriate pins on both FSB agents.															
DEFER#	Input	DEFER# is asserted by an agent to indicate that a transaction cannot be guaranteed in-order completion. Assertion of DEFER# is normally the responsibility of the addressed memory or Input/Output agent. This signal must connect the appropriate pins of both FSB agents.															



Table 22. Signal Description (Sheet 3 of 7)

Name	Type	Description										
DINV[3:0]#	Input/Output	<p>DINV[3:0]# (Data Bus Inversion) are source synchronous and indicate the polarity of the D[63:0]# signals. The DINV[3:0]# signals are activated when the data on the data bus is inverted. The bus agent inverts the data bus signals if more than half the bits, within the covered group, would change level in the next cycle.</p> <p>DINV[3:0]# Assignment To Data Bus</p> <table border="1"> <thead> <tr> <th>Bus Signal</th> <th>Data Bus Signals</th> </tr> </thead> <tbody> <tr> <td>DINV[3]#</td> <td>D[63:48]#</td> </tr> <tr> <td>DINV[2]#</td> <td>D[47:32]#</td> </tr> <tr> <td>DINV[1]#</td> <td>D[31:16]#</td> </tr> <tr> <td>DINV[0]#</td> <td>D[15:0]#</td> </tr> </tbody> </table>	Bus Signal	Data Bus Signals	DINV[3]#	D[63:48]#	DINV[2]#	D[47:32]#	DINV[1]#	D[31:16]#	DINV[0]#	D[15:0]#
Bus Signal	Data Bus Signals											
DINV[3]#	D[63:48]#											
DINV[2]#	D[47:32]#											
DINV[1]#	D[31:16]#											
DINV[0]#	D[15:0]#											
DPRSTP#	Input	DPRSTP# when asserted on the platform causes the processor to transition from the Deep Sleep State to the Deeper Sleep state. In order to return to the Deep Sleep State, DPRSTP# must be deasserted. DPRSTP# is driven by the Intel 82801HBM ICH8M I/O Controller Hub-based chipset.										
DPSLP#	Input	DPSLP# when asserted on the platform causes the processor to transition from the Sleep State to the Deep Sleep state. In order to return to the Sleep State, DPSLP# must be deasserted. DPSLP# is driven by the Intel 82801HBM ICH8M chipset.										
DPWR#	Input/Output	DPWR# is a control signal used by the chipset to reduce power on the processor data bus input buffers. The processor drives this pin during dynamic FSB frequency switching.										
DRDY#	Input/Output	DRDY# (Data Ready) is asserted by the data driver on each data transfer, indicating valid data on the data bus. In a multi-common clock data transfer, DRDY# may be deasserted to insert idle clocks. This signal must connect the appropriate pins of both FSB agents.										
DSTBN[3:0]#	Input/Output	<p>Data strobe used to latch in D[63:0]#.</p> <table border="1"> <thead> <tr> <th>Signals</th> <th>Associated Strobe</th> </tr> </thead> <tbody> <tr> <td>D[15:0]#, DINV[0]#</td> <td>DSTBN[0]#</td> </tr> <tr> <td>D[31:16]#, DINV[1]#</td> <td>DSTBN[1]#</td> </tr> <tr> <td>D[47:32]#, DINV[2]#</td> <td>DSTBN[2]#</td> </tr> <tr> <td>D[63:48]#, DINV[3]#</td> <td>DSTBN[3]#</td> </tr> </tbody> </table>	Signals	Associated Strobe	D[15:0]#, DINV[0]#	DSTBN[0]#	D[31:16]#, DINV[1]#	DSTBN[1]#	D[47:32]#, DINV[2]#	DSTBN[2]#	D[63:48]#, DINV[3]#	DSTBN[3]#
Signals	Associated Strobe											
D[15:0]#, DINV[0]#	DSTBN[0]#											
D[31:16]#, DINV[1]#	DSTBN[1]#											
D[47:32]#, DINV[2]#	DSTBN[2]#											
D[63:48]#, DINV[3]#	DSTBN[3]#											
DSTBP[3:0]#	Input/Output	<p>Data strobe used to latch in D[63:0]#.</p> <table border="1"> <thead> <tr> <th>Signals</th> <th>Associated Strobe</th> </tr> </thead> <tbody> <tr> <td>D[15:0]#, DINV[0]#</td> <td>DSTBP[0]#</td> </tr> <tr> <td>D[31:16]#, DINV[1]#</td> <td>DSTBP[1]#</td> </tr> <tr> <td>D[47:32]#, DINV[2]#</td> <td>DSTBP[2]#</td> </tr> <tr> <td>D[63:48]#, DINV[3]#</td> <td>DSTBP[3]#</td> </tr> </tbody> </table>	Signals	Associated Strobe	D[15:0]#, DINV[0]#	DSTBP[0]#	D[31:16]#, DINV[1]#	DSTBP[1]#	D[47:32]#, DINV[2]#	DSTBP[2]#	D[63:48]#, DINV[3]#	DSTBP[3]#
Signals	Associated Strobe											
D[15:0]#, DINV[0]#	DSTBP[0]#											
D[31:16]#, DINV[1]#	DSTBP[1]#											
D[47:32]#, DINV[2]#	DSTBP[2]#											
D[63:48]#, DINV[3]#	DSTBP[3]#											



Table 22. Signal Description (Sheet 4 of 7)

Name	Type	Description
FERR#/PBE#	Output	<p>FERR# (Floating-point Error)/PBE#(Pending Break Event) is a multiplexed signal and its meaning is qualified with STPCLK#. When STPCLK# is not asserted, FERR#/PBE# indicates a floating point when the processor detects an unmasked floating-point error. FERR# is similar to the ERROR# signal on the Intel 387 coprocessor, and is included for compatibility with systems using MS-DOS*-type floating-point error reporting. When STPCLK# is asserted, an assertion of FERR#/PBE# indicates that the processor has a pending break event waiting for service. The assertion of FERR#/PBE# indicates that the processor should be returned to the Normal state. When FERR#/PBE# is asserted, indicating a break event, it remains asserted until STPCLK# is deasserted. Assertion of PREQ# when STPCLK# is active also causes an FERR# break event.</p> <p>For additional information on the pending break event functionality, including identification of support of the feature and enable/disable information, refer to Volumes 3A and 3B of the <i>Intel® 64 and IA-32 Architectures Software Developer's Manual</i> and the <i>Intel® Processor Identification and CPUID Instruction</i> application note.</p>
GTLREF	Input	<p>GTLREF determines the signal reference level for AGTL+ input pins. GTLREF should be set at $2/3 V_{CCP}$. GTLREF is used by the AGTL+ receivers to determine if a signal is a logical 0 or logical 1.</p>
HIT# HITM#	Input/ Output Input/ Output	<p>HIT# (Snoop Hit) and HITM# (Hit Modified) convey transaction snoop operation results. Either FSB agent may assert both HIT# and HITM# together to indicate that it requires a snoop stall, which can be continued by reasserting HIT# and HITM# together.</p>
IERR#	Output	<p>IERR# (Internal Error) is asserted by a processor as the result of an internal error. Assertion of IERR# is usually accompanied by a SHUTDOWN transaction on the FSB. This transaction may optionally be converted to an external error signal (e.g., NMI) by system core logic. The processor keeps IERR# asserted until the assertion of RESET#, BINIT#, or INIT#.</p>
IGNNE#	Input	<p>IGNNE# (Ignore Numeric Error) is asserted to force the processor to ignore a numeric error and continue to execute noncontrol floating-point instructions. If IGNNE# is deasserted, the processor generates an exception on a noncontrol floating-point instruction if a previous floating-point instruction caused an error. IGNNE# has no effect when the NE bit in control register 0 (CRO) is set.</p> <p>IGNNE# is an asynchronous signal. However, to ensure recognition of this signal following an Input/Output write instruction, it must be valid along with the TRDY# assertion of the corresponding Input/Output Write bus transaction.</p>
INIT#	Input	<p>INIT# (Initialization), when asserted, resets integer registers inside the processor without affecting its internal caches or floating-point registers. The processor then begins execution at the power-on Reset vector configured during power-on configuration. The processor continues to handle snoop requests during INIT# assertion. INIT# is an asynchronous signal. However, to ensure recognition of this signal following an Input/Output Write instruction, it must be valid along with the TRDY# assertion of the corresponding Input/Output Write bus transaction. INIT# must connect the appropriate pins of both FSB agents.</p> <p>If INIT# is sampled active on the active to inactive transition of RESET#, then the processor executes its Built-in Self-Test (BIST)</p>

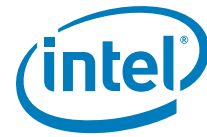

Table 22. Signal Description (Sheet 5 of 7)

Name	Type	Description
LINT[1:0]	Input	<p>LINT[1:0] (Local APIC Interrupt) must connect the appropriate pins of all APIC Bus agents. When the APIC is disabled, the LINT0 signal becomes INTR, a maskable interrupt request signal, and LINT1 becomes NMI, a nonmaskable interrupt. INTR and NMI are backward compatible with the signals of those names on the Intel® Pentium® processor. Both signals are asynchronous.</p> <p>Both of these signals must be software configured via BIOS programming of the APIC register space to be used either as NMI/INTR or LINT[1:0]. Because the APIC is enabled by default after Reset, operation of these pins as LINT[1:0] is the default configuration.</p>
LOCK#	Input/ Output	<p>LOCK# indicates to the system that a transaction must occur atomically. This signal must connect the appropriate pins of both FSB agents. For a locked sequence of transactions, LOCK# is asserted from the beginning of the first transaction to the end of the last transaction.</p> <p>When the priority agent asserts BPRI# to arbitrate for ownership of the FSB, it waits until it observes LOCK# deasserted. This enables symmetric agents to retain ownership of the FSB throughout the bus locked operation and ensure the atomicity of lock.</p>
PRDY#	Output	<p>Probe Ready signal used by debug tools to determine processor debug readiness.</p>
PREQ#	Input	<p>Probe Request signal used by debug tools to request debug operation of the processor.</p>
PROCHOT#	Input/ Output	<p>As an output, PROCHOT# (Processor Hot) goes active when the processor temperature monitoring sensor detects that the processor has reached its maximum safe operating temperature. This indicates that the processor Thermal Control Circuit (TCC) has been activated, if enabled. As an input, assertion of PROCHOT# by the system activates the TCC, if enabled. The TCC remains active until the system deasserts PROCHOT#.</p> <p>By default PROCHOT# is configured as an output. The processor must be enabled via the BIOS for PROCHOT# to be configured as bidirectional.</p> <p>This signal may require voltage translation on the motherboard.</p>
PSI#	Output	<p>Processor Power Status Indicator signal. This signal is asserted when the processor is in both in the Normal state (HFM to LFM) and in lower power states (Deep Sleep and Deeper Sleep).</p>
PWRGOOD	Input	<p>PWRGOOD (Power Good) is a processor input. The processor requires this signal to be a clean indication that the clocks and power supplies are stable and within their specifications. 'Clean' implies that the signal remains low (capable of sinking leakage current), without glitches, from the time that the power supplies are turned on until they come within specification. The signal must then transition monotonically to a high state. PWRGOOD can be driven inactive at any time, but clocks and power must again be stable before a subsequent rising edge of PWRGOOD.</p> <p>The PWRGOOD signal must be supplied to the processor; it is used to protect internal circuits against voltage sequencing issues. It should be driven high throughout boundary scan operation.</p>
REQ[4:0]#	Input/ Output	<p>REQ[4:0]# (Request Command) must connect the appropriate pins of both FSB agents. They are asserted by the current bus owner to define the currently active transaction type. These signals are source synchronous to ADSTB[0]#.</p>



Table 22. Signal Description (Sheet 6 of 7)

Name	Type	Description
RESET#	Input	Asserting the RESET# signal resets the processor to a known state and invalidates its internal caches without writing back any of their contents. For a power-on Reset, RESET# must stay active for at least two milliseconds after V _{CC} and BCLK have reached their proper specifications. On observing active RESET#, both FSB agents deasserts their outputs within two clocks. All processor straps must be valid within the specified setup time before RESET# is deasserted. There is a 55-Ω (nominal) on die pull-up resistor on this signal.
RS[2:0]#	Input	RS[2:0]# (Response Status) are driven by the response agent (the agent responsible for completion of the current transaction), and must connect the appropriate pins of both FSB agents.
RSVD	Reserved /No Connect	These pins are RESERVED and must be left unconnected on the board. However, it is recommended that routing channels to these pins on the board be kept open for possible future use.
SLP#	Input	SLP# (Sleep), when asserted in Stop-Grant state, causes the processor to enter the Sleep state. During Sleep state, the processor stops providing internal clock signals to all units, leaving only the Phase-Locked Loop (PLL) still operating. Processors in this state does not recognize snoops or interrupts. The processor recognizes only assertion of the RESET# signal, deassertion of SLP#, and removal of the BCLK input while in Sleep state. If SLP# is deasserted, the processor exits Sleep state and returns to Stop-Grant state, restarting its internal clock signals to the bus and processor core units. If DPSP# is asserted while in the Sleep state, the processor exits the Sleep state and transition to the Deep Sleep state.
SMI#	Input	SMI# (System Management Interrupt) is asserted asynchronously by system logic. On accepting a System Management Interrupt, the processor saves the current state and enters System Management Mode (SMM). An SMI Acknowledge transaction is issued and the processor begins program execution from the SMM handler. If an SMI# is asserted during the deassertion of RESET#, then the processor tristates its outputs.
STPCLK#	Input	STPCLK# (Stop Clock), when asserted, causes the processor to enter a low power Stop-Grant state. The processor issues a Stop-Grant Acknowledge transaction, and stops providing internal clock signals to all processor core units except the FSB and APIC units. The processor continues to snoop bus transactions and service interrupts while in Stop-Grant state. When STPCLK# is deasserted, the processor restarts its internal clock to all units and resumes execution. The assertion of STPCLK# has no effect on the bus clock; STPCLK# is an asynchronous input.
TCK	Input	TCK (Test Clock) provides the clock input for the processor Test Bus (also known as the Test Access Port).
TDI	Input	TDI (Test Data In) transfers serial test data into the processor. TDI provides the serial input needed for JTAG specification support.
TDO	Output	TDO (Test Data Out) transfers serial test data out of the processor. TDO provides the serial output needed for JTAG specification support.
TEST1, TEST2, TEST3, TEST4, TEST5, TEST6	Input	TEST1 and TEST2 must have a stuffing option of separate pulldown resistors to V _{SS} . For the purpose of testability, route the TEST3 and TEST5 signals through a ground-referenced Zo=55 Ω trace that ends in a via that is near a GND via and is accessible through an oscilloscope connection.
THRMDA	Other	Thermal Diode Anode.
THRMDC	Other	Thermal Diode Cathode.



Table 22. Signal Description (Sheet 7 of 7)

Name	Type	Description
THERMTRIP#	Output	The processor protects itself from catastrophic overheating by use of an internal thermal sensor. This sensor is set well above the normal operating temperature to ensure that there are no false trips. The processor stops all execution when the junction temperature exceeds approximately 125 °C. This is signalled to the system by the THERMTRIP# (Thermal Trip) pin.
TMS	Input	TMS (Test Mode Select) is a JTAG specification support signal used by debug tools.
TRDY#	Input	TRDY# (Target Ready) is asserted by the target to indicate that it is ready to receive a write or implicit writeback data transfer. TRDY# must connect the appropriate pins of both FSB agents.
TRST#	Input	TRST# (Test Reset) resets the Test Access Port (TAP) logic. TRST# must be driven low during power on Reset.
V _{CC}	Input	Processor core power supply.
V _{SS}	Input	Processor core ground node.
V _{CCA}	Input	V _{CCA} provides isolated power for the internal processor core PLL's.
V _{CCP}	Input	Processor I/O Power Supply.
V _{CC_SENSE}	Output	V _{CC_SENSE} together with V _{SS_SENSE} are voltage feedback signals to Intel® MVP-6 that control the 2.1-mΩ loadline at the processor die. It should be used to sense voltage near the silicon with little noise.
VID[6:0]	Output	VID[6:0] (Voltage ID) pins are used to support automatic selection of power supply voltages (V _{CC}). Unlike some previous generations of processors, these are CMOS signals that are driven by the processor. The voltage supply for these pins must be valid before the VR can supply V _{CC} to the processor. Conversely, the VR output must be disabled until the voltage supply for the VID pins becomes valid. The VID pins are needed to support the processor voltage specification variations. See Table 2 for definitions of these pins. The VR must supply the voltage that is requested by the pins, or disable itself.
V _{SS_SENSE}	Output	V _{SS_SENSE} together with V _{CC_SENSE} are voltage feedback signals to Intel MVP-6 that control the 2.1-mΩ loadline at the processor die. It should be used to sense ground near the silicon with little noise.

§



Package Mechanical Specifications and Pin Information



5 Thermal Specifications and Design Considerations

Maintaining the proper thermal environment is key to reliable, long-term system operation. A complete thermal solution includes both component and system level thermal management features. The system/processor thermal solution should be designed so that the processor remains within the minimum and maximum junction temperature (T_J) specifications at the corresponding thermal design power (TDP) value listed in Table 24 through Table 26.

Caution: Operating the processor outside these limits may result in permanent damage to the processor and potentially other components in the system.

Table 23. Power Specifications for the 3x00 Celeron Processors

Symbol	Processor Number	Core Frequency & Voltage	Thermal Design Power			Unit	Notes
TDP	T1600	1.66 GHz	35			W	1, 4, 5, 6, 9
TDP	T1700	1.83 GHz	35			W	1, 4, 5, 6, 9
Symbol	Parameter		Min	Typ	Max	Unit	
P_{AH} , P_{SGNT}	Auto Halt, Stop Grant Power at HFM V_{CC}				13.9	W	2, 5, 7
P_{SLP}	Sleep Power at V_{CC}				13.1	W	2, 5, 7
$P_{DSL P}$	Deep Sleep Power at V_{CC}				5.5	W	2, 5, 8
T_J	Junction Temperature		0		105	°C	3, 4

Table 24. Power Specifications for the Intel Celeron Dual-Core Processor - Standard Voltage

Symbol	Processor Number	Core Frequency & Voltage	Thermal Design Power			Unit	Notes
TDP	T1600	1.66 GHz	35			W	1, 4, 5, 6, 9
TDP	T1700	1.83 GHz	35			W	1, 4, 5, 6, 9
Symbol	Parameter		Min	Typ	Max	Unit	
P_{AH} , P_{SGNT}	Auto Halt, Stop Grant Power at HFM V_{CC}				13.5	W	2, 5, 7
P_{SLP}	Sleep Power at V_{CC}				12.9	W	2, 5, 7
$P_{DSL P}$	Deep Sleep Power at V_{CC}				7.7	W	2, 5, 8
T_J	Junction Temperature		0		100	°C	3, 4

NOTES:

- The TDP specification should be used to design the processor thermal solution. The TDP is not the maximum theoretical power the processor can generate.
- Not 100% tested. These power specifications are determined by characterization of the processor currents at higher temperatures and extrapolating the values for the temperature indicated.



3. As measured by the activation of the on-die Intel Thermal Monitor. The Intel Thermal Monitor's automatic mode is used to indicate that the maximum T_j has been reached. Refer to [Section 5.1](#) for details.
4. The Intel Thermal Monitor automatic mode must be enabled for the processor to operate within specifications.
5. At T_j of 100 °C
6. At T_j of 50 °C
7. At T_j of 35 °C
8. 512-KB L2 cache

Table 25. Power Specifications for the Ultra Low Voltage Dual-Core 1M Cache Intel Celeron (SFF) Genuine Intel Processor

Symbol	Processor Number	Core Frequency	Thermal Design Power			Unit	Notes
			Min	Typ	Max		
TDP	SU2300	1.2 GHz	10			W	1, 4, 5
Symbol	Parameter		Min	Typ	Max	Unit	Notes
P_{AH} , P_{SGNT}	Auto Halt, Stop Grant Power				2.9	W	2, 6
P_{SLP}	Sleep Power				2.9	W	2, 6
P_{DRLP}	Deep Sleep Power				1.3	W	2,7
P_{DPRSLP}	Deeper Sleep Power				0.6	W	2, 7
T_j	Junction Temperature		0		100	°C	3,4

NOTES:

1. The TDP specification should be used to design the processor thermal solution. The TDP is not the maximum theoretical power the processor can generate.
2. Not 100% tested. These power specifications are determined by characterization of the processor currents at higher temperatures and extrapolating the values for the temperature indicated.
3. As measured by the activation of the on-die Intel Thermal Monitor. The Intel Thermal Monitor's automatic mode is used to indicate that the maximum T_j has been reached. Refer to [Section 5.1](#) for more details.
4. The Intel Thermal Monitor automatic mode must be enabled for the processor to operate within specifications.
5. At T_j of 100 °C
6. At T_j of 50 °C
7. At T_j of 35 °C

5.1 Monitoring Die Temperature

The processor incorporates three methods of monitoring die temperature:

- Thermal Diode
- Intel Thermal Monitor
- Digital Thermal Sensor



5.1.1 Thermal Diode

The processor incorporates an on-die PNP transistor whose base emitter junction is used as a thermal diode, with its collector shorted to ground. The thermal diode can be read by an off-die analog/digital converter (a thermal sensor) located on the motherboard or a stand-alone measurement kit. The thermal diode may be used to monitor the die temperature of the processor for thermal management or instrumentation purposes but is not a reliable indication that the maximum operating temperature of the processor has been reached. When using the thermal diode, a temperature offset value must be read from a processor MSR and applied. See [Section 5.1.2](#) for more details. Please see [Section 5.1.3](#) for thermal diode usage recommendation when the PROCHOT# signal is not asserted.

The reading of the external thermal sensor (on the motherboard) connected to the processor thermal diode signals does not reflect the temperature of the hottest location on the die. This is due to inaccuracies in the external thermal sensor, on-die temperature gradients between the location of the thermal diode and the hottest location on the die, and time based variations in the die temperature measurement. Time-based variations can occur when the sampling rate of the thermal diode (by the thermal sensor) is slower than the rate at which the T_j temperature can change.

Offset between the thermal diode-based temperature reading and the Intel Thermal Monitor reading may be characterized using the Intel Thermal Monitor's Automatic mode activation of the thermal control circuit. This temperature offset must be taken into account when using the processor thermal diode to implement power management events. This offset is different than the diode Toffset value programmed into the processor Model Specific Register (MSR).

[Table 26](#) to [Table 29](#) provide the diode interface and specifications. The diode model parameters apply to the traditional thermal sensors that use the diode equation to determine the processor temperature. Transistor model parameters have been added to support thermal sensors that use the transistor equation method. The Transistor model may provide more accurate temperature measurements when the diode ideality factor is closer to the maximum or minimum limits. Contact your external sensor supplier for recommendations. The thermal diode is separate from the Intel Thermal Monitor's thermal sensor and cannot be used to predict the behavior of the Intel Thermal Monitor.

Table 26. Thermal Diode Interface

Signal Name	Pin/Ball Number	Signal Description
THERMDA	A24	Thermal diode anode
THERMDC	A25	Thermal diode cathode



Table 27. Thermal Diode Parameters Using Diode Model

Symbol	Parameter	Min	Typ	Max	Unit	Notes
I _{FW}	Forward Bias Current	5		200	μA	1
n	Diode Ideality Factor	1.000	1.009	1.050		2, 3, 4
R _T	Series Resistance	2.79	4.52	6.24	Ω	2, 3, 5

NOTES:

- Intel does not support or recommend operation of the thermal diode under reverse bias. Intel does not support or recommend operation of the thermal diode when the processor power supplies are not within their specified tolerance range.
- Characterized across a temperature range of 50-100°C.
- Not 100% tested. Specified by design characterization.
- The ideality factor, n, represents the deviation from ideal diode behavior as exemplified by the diode equation:

$$I_{FW} = I_S * (e^{qV_D/nkT} - 1)$$

where I_S = saturation current, q = electronic charge, V_D = voltage across the diode, k = Boltzmann Constant, and T = absolute temperature (Kelvin).

- The series resistance, R_T, is provided to allow for a more accurate measurement of the junction temperature. R_T, as defined, includes the lands of the processor but does not include any socket resistance or board trace resistance between the socket and the external remote diode thermal sensor. R_T can be used by remote diode thermal sensors with automatic series resistance cancellation to calibrate out this error term. Another application is that a temperature offset can be manually calculated and programmed into an offset register in the remote diode thermal sensors as exemplified by the equation:

$$T_{error} = [R_T * (N-1) * I_{FWmin}] / [nk/q * \ln N]$$

where T_{error} = sensor temperature error, N = sensor current ratio, k = Boltzmann Constant, q = electronic charge.



Table 28. Thermal Diode Parameters Using Transistor Model

Symbol	Parameter	Min	Typ	Max	Unit	Notes
I_{FW}	Forward Bias Current	5		200	μA	1,2
I_E	Emitter Current	5		200	μA	1
n_Q	Transistor Ideality	0.997	1.001	1.005		3,4,5
Beta		0.3		0.760		3,4
R_T	Series Resistance	2.79	4.52	6.24	Ω	3,6

NOTES:

1. Intel does not support or recommend operation of the thermal diode under reverse bias.
2. Same as I_{FW} in [Table 27](#).
3. Characterized across a temperature range of 50-100°C.
4. Not 100% tested. Specified by design characterization.
5. The ideality factor, n_Q , represents the deviation from ideal transistor model behavior as exemplified by the equation for the collector current:

$$I_C = I_S * (e^{qV_{BE}/n_QkT} - 1)$$

where I_S = saturation current, q = electronic charge, V_{BE} = voltage across the transistor base emitter junction (same nodes as VD), k = Boltzmann Constant, and T = absolute temperature (Kelvin).

6. The series resistance, R_T , provided in the Diode Model Table ([Table 27](#)) can be used for more accurate readings as needed.

When calculating a temperature based on the thermal diode measurements, a number of parameters must be either measured or assumed. Most devices measure the diode ideality and assume a series resistance and ideality trim value, although are capable of also measuring the series resistance. Calculating the temperature is then accomplished using the equations listed under [Table 27](#). In most sensing devices, an expected value for the diode ideality is designed-in to the temperature calculation equation. If the designer of the temperature sensing device assumes a perfect diode, the ideality value (also called n_{trim}) is 1.000. Given that most diodes are not perfect, the designers usually select an n_{trim} value that more closely matches the behavior of the diodes in the processor. If the processor diode ideality deviates from that of the n_{trim} , each calculated temperature offsets by a fixed amount. This temperature offset can be calculated with the equation:

$$T_{error(nf)} = T_{measured} * (1 - n_{actual}/n_{trim})$$

where $T_{error(nf)}$ is the offset in degrees C, $T_{measured}$ is in Kelvin, n_{actual} is the measured ideality of the diode, and n_{trim} is the diode ideality assumed by the temperature sensing device.

5.1.2 Thermal Diode Offset

In order to improve the accuracy of the diode-based temperature measurements, a temperature offset value (specified as T_{offset}) is programmed in the processor MSR which contains thermal diode characterization data. During manufacturing each processor thermal diode is evaluated for its behavior relative to the theoretical diode. Using the equation above, the temperature error created by the difference n_{trim} and the actual ideality of the particular processor is calculated.



If the n_{trim} value used to calculate the Toffset differs from the n_{trim} value used to in a temperature sensing device, the $T_{error(nf)}$ may not be accurate. If desired, the Toffset can be adjusted by calculating n_{actual} and then recalculating the offset using the n_{trim} as defined in the temperature sensor manufacturer’s datasheet.

The n_{trim} used to calculate the Diode Correction Toffset are listed in Table 29.

Table 29. Thermal Diode n_{trim} and Diode Correction Toffset

Symbol	Parameter	Value
n_{trim}	Diode Ideality used to calculate Toffset	1.01

5.1.3 Intel® Thermal Monitor

The Intel Thermal Monitor helps control the processor temperature by activating the TCC (Thermal Control Circuit) when the processor silicon reaches its maximum operating temperature. The temperature at which the Intel Thermal Monitor activates the TCC is not user configurable. Bus traffic is snooped in the normal manner and interrupt requests are latched (and serviced during the time that the clocks are on) while the TCC is active.

With a properly designed and characterized thermal solution, it is anticipated that the TCC would only be activated for very short periods of time when running the most power intensive applications. The processor performance impact due to these brief periods of TCC activation is expected to be minor and hence not detectable. An under-designed thermal solution that is not able to prevent excessive activation of the TCC in the anticipated ambient environment may cause a noticeable performance loss and may affect the long-term reliability of the processor. In addition, a thermal solution that is significantly under-designed may not be capable of cooling the processor even when the TCC is active continuously.

The Intel Thermal Monitor controls the processor temperature by modulating (starting and stopping) the processor core clocks when the processor silicon reaches its maximum operating temperature. The Intel Thermal Monitor uses two modes to activate the TCC: automatic mode and on-demand mode. If both modes are activated, automatic mode takes precedence.

There are two automatic modes called Intel Thermal Monitor 1 and Intel Thermal Monitor 2. These modes are selected by writing values to the MSRs of the processor. After automatic mode is enabled, the TCC activates only when the internal die temperature reaches the maximum allowed value for operation.

When Intel Thermal Monitor 1 is enabled and a high temperature situation exists, the clocks modulates by alternately turning the clocks off and on at a 50% duty cycle. Cycle times are processor speed dependent and decreases linearly as processor core frequencies increase. Once the temperature has returned to a non-critical level, modulation ceases and TCC goes inactive. A small amount of hysteresis has been included to prevent rapid active/inactive transitions of the TCC when the processor temperature is near the trip point. The duty cycle is factory configured and cannot be modified. Also, automatic mode does not require any additional hardware, software drivers, or interrupt handling routines. Processor performance decreases by the same amount as the duty cycle when the TCC is active.

Note: Intel Thermal Monitor 1 and Intel Thermal Monitor 2 features are collectively referred to as Adaptive Thermal Monitoring features. Intel recommends Intel Thermal Monitor 1 and 2 be enabled on the processors.



Intel Thermal Monitor 1 and 2 can co-exist within the processor. If both Intel Thermal Monitor 1 and 2 bits are enabled in the auto-throttle MSR, Intel Thermal Monitor 2 takes precedence over Intel Thermal Monitor 1. However, if Force Intel Thermal Monitor 1 over Intel Thermal Monitor 2 is enabled in MSRs via BIOS and Intel Thermal Monitor 2 is not sufficient to cool the processor below the maximum operating temperature, then Intel Thermal Monitor 1 also activates to help cool down the processor.

The TCC may also be activated via on-demand mode. If Bit 4 of the ACPI Intel Thermal Monitor control register is written to a 1, the TCC activates immediately independent of the processor temperature. When using on-demand mode to activate the TCC, the duty cycle of the clock modulation is programmable via bits 3:1 of the same ACPI Intel Thermal Monitor control register. In automatic mode, the duty cycle is fixed at 50% on, 50% off, however in on-demand mode, the duty cycle can be programmed from 12.5% on/ 87.5% off, to 87.5% on/12.5% off in 12.5% increments. On-demand mode may be used at the same time automatic mode is enabled, however, if the system tries to enable the TCC via on-demand mode at the same time automatic mode is enabled and a high temperature condition exists, automatic mode takes precedence.

An external signal, PROCHOT# (processor hot) is asserted when the processor detects that its temperature is above the thermal trip point. Bus snooping and interrupt latching are also active while the TCC is active.

Besides the thermal sensor and thermal control circuit, the Intel Thermal Monitor also includes one ACPI register, one performance counter register, three MSR, and one I/O pin (PROCHOT#). All are available to monitor and control the state of the Intel Thermal Monitor feature. The Intel Thermal Monitor can be configured to generate an interrupt upon the assertion or deassertion of PROCHOT#.

PROCHOT# is not be asserted when the processor is in the Stop Grant, Sleep, Deep Sleep, and Deeper Sleep low power states, hence the thermal diode reading must be used as a safeguard to maintain the processor junction temperature within maximum specification. If the platform thermal solution is not able to maintain the processor junction temperature within the maximum specification, the system must initiate an orderly shutdown to prevent damage. If the processor enters one of the above low power states with PROCHOT# already asserted, PROCHOT# will remain asserted until the processor exits the low power state and the processor junction temperature drops below the thermal trip point.

If Intel Thermal Monitor automatic mode is disabled, the processor will be operating out of specification. Regardless of enabling the automatic or on-demand modes, in the event of a catastrophic cooling failure, the processor will automatically shut down when the silicon has reached a temperature of approximately 125°C. At this point the THERMTRIP# signal will go active. THERMTRIP# activation is independent of processor activity and does not generate any bus cycles. When THERMTRIP# is asserted, the processor core voltage must be shut down within the time specified in [Chapter 3](#).

In all cases, the Intel Thermal Monitor feature must be enabled for the processor to remain within specification.

5.1.4 Digital Thermal Sensor

The processor also contains an on die Digital Thermal Sensor (DTS) that can be read via an MSR (no I/O interface). Each core of the processor will have a unique digital thermal sensor whose temperature is accessible via the processor MSRs. The DTS is the preferred method of reading the processor die temperature since it can be located much closer to the hottest portions of the die and can thus more accurately track the die temperature and potential activation of processor core clock modulation via the Intel Thermal Monitor. The DTS is only valid while the processor is in the normal operating state (the Normal package level low-power state).



Unlike traditional thermal devices, the DTS will output a temperature relative to the maximum supported operating temperature of the processor ($T_{J,max}$). It is the responsibility of software to convert the relative temperature to an absolute temperature. The temperature returned by the DTS will always be at or below $T_{J,max}$. Catastrophic temperature conditions are detectable via an Out Of Spec status bit. This bit is also part of the DTS MSR. When this bit is set, the processor is operating out of specification and immediate shutdown of the system should occur. The processor operation and code execution is not guaranteed once the activation of the Out of Spec status bit is set.

The DTS-relative temperature readout corresponds to the Intel Thermal Monitor 1/Intel Thermal Monitor 2 trigger point. When the DTS indicates maximum processor core temperature has been reached, the Intel Thermal Monitor 1 or 2 hardware thermal control mechanism will activate. The DTS and Intel Thermal Monitor 1/Intel Thermal Monitor 2 temperature may not correspond to the thermal diode reading because the thermal diode is located in a separate portion of the die and thermal gradient between the individual core DTS. Additionally, the thermal gradient from DTS to thermal diode can vary substantially due to changes in processor power, mechanical and thermal attach, and software application. The system designer is required to use the DTS to guarantee proper operation of the processor within its temperature operating specifications.

Changes to the temperature can be detected via two programmable thresholds located in the processor MSRs. These thresholds have the capability of generating interrupts via the core's local APIC. Refer to the *Intel® 64 and IA-32 Architectures Software Developer's Manual* for specific register and programming details.

5.1.5 Out of Specification Detection

Overheat detection is performed by monitoring the processor temperature and temperature gradient. This feature is intended for graceful shut down before the THERMTRIP# is activated. If the processor's Intel Thermal Monitor 1 or 2 are triggered and the temperature remains high, an "Out Of Spec" status and sticky bit are latched in the status MSR register and generates thermal interrupt.

5.1.6 PROCHOT# Signal Pin

An external signal, PROCHOT# (processor hot), is asserted when the processor die temperature has reached its maximum operating temperature. If Intel Thermal Monitor 1 or 2 is enabled, then the TCC will be active when PROCHOT# is asserted. The processor can be configured to generate an interrupt upon the assertion or deassertion of PROCHOT#. Refer to the *Intel® 64 and IA-32 Architectures Software Developer's Manual* for specific register and programming details.

The processor implements a bi-directional PROCHOT# capability to allow system designs to protect various components from overheating situations. The PROCHOT# signal is bi-directional in that it can either signal when the processor has reached its maximum operating temperature or be driven from an external source to activate the TCC. The ability to activate the TCC via PROCHOT# can provide a means for thermal protection of system components.

Only a single PROCHOT# pin exists at a package level of the processor. When either core's thermal sensor trips, the PROCHOT# signal will be driven by the processor package. If only Intel Thermal Monitor 1 is enabled, PROCHOT# will be asserted and only the core that is above TCC temperature trip point will have its core clocks modulated. If Intel Thermal Monitor 2 is enabled, then regardless of which core(s) are above TCC temperature trip point, both cores will enter the lowest programmed Intel Thermal Monitor 2 performance state. It is important to note that Intel recommends both Intel Thermal Monitor 1 and 2 to be enabled.



When PROCHOT# is driven by an external agent, if only Intel Thermal Monitor 1 is enabled on both cores, then both processor cores will have their core clocks modulated. If Intel Thermal Monitor 2 is enabled on both cores, then both processor cores will enter the lowest programmed Intel Thermal Monitor 2 performance state. It should be noted that Force Intel Thermal Monitor 1 on Intel Thermal Monitor 2, enabled via BIOS, does not have any effect on external PROCHOT#. If PROCHOT# is driven by an external agent when Intel Thermal Monitor 1, Intel Thermal Monitor 2, and Force Intel Thermal Monitor 1 on Intel Thermal Monitor 2 are all enabled, then the processor will still apply only Intel Thermal Monitor 2.

PROCHOT# may be used for thermal protection of voltage regulators (VR). System designers can create a circuit to monitor the VR temperature and activate the TCC when the temperature limit of the VR is reached. By asserting PROCHOT# (pulled-low) and activating the TCC, the VR will cool down as a result of reduced processor power consumption. Bi-directional PROCHOT# can allow VR thermal designs to target maximum sustained current instead of maximum current. Systems should still provide proper cooling for the VR and rely on bi-directional PROCHOT# only as a backup in case of system cooling failure. The system thermal design should allow the power delivery circuitry to operate within its temperature specification even while the processor is operating at its TDP. With a properly designed and characterized thermal solution, it is anticipated that bi-directional PROCHOT# would only be asserted for very short periods of time when running the most power intensive applications. An under-designed thermal solution that is not able to prevent excessive assertion of PROCHOT# in the anticipated ambient environment may cause a noticeable performance loss.

§





1	Coordination of Core-Level Low-Power States at the Package Level	11
2	Voltage Identification Definition	19
3	BSEL[2:0] Encoding for BCLK Frequency	23
4	FSB Pin Groups	24
5	Processor Absolute Maximum Ratings	25
6	DC Voltage and Current Specifications for the T3x00 Celeron Processors	27
7	DC Voltage and Current Specifications for the T1x00 Celeron Mobile Processors.....	28
8	Voltage and Current Specifications for the Ultra Low Voltage Dual-Core 1M Cache Intel Celeron SFF Genuine Intel Processor.....	29
9	FSB Differential BCLK Specifications	30
10	AGTL+ Signal Group DC Specifications.....	31
11	CMOS Signal Group DC Specifications	32
12	Open Drain Signal Group DC Specifications.....	32
13	The Coordinates of the Processor Pins as Viewed from the Top of the Package (Sheet 1 of 2).....	39
14	The Coordinates of the Processor Pins as Viewed from the Top of the Package (Sheet 2 of 2)	40
15	SFF Processor Top View Upper Left Side	41
16	SFF Processor Top View Upper Right Side	42
17	SFF Processor Top View Lower Left Side	43
18	SFF Processor Top View Lower Right Side	44
19	Pin Listing by Pin Name.....	45
20	Pin Listing by Pin Number.....	52
21	SFF Listing by Ball Name.....	61
22	Signal Description	75
23	Power Specifications for the 3x00 Celeron Processors.....	83
24	Power Specifications for the Intel Celeron Dual-Core Processor - Standard Voltage.....	83
25	Power Specifications for the Ultra Low Voltage Dual-Core 1M Cache Intel Celeron (SFF) Genuine Intel Processor	84
26	Thermal Diode Interface	85
27	Thermal Diode Parameters Using Diode Model.....	86
28	Thermal Diode Parameters Using Transistor Model.....	87
29	Thermal Diode ntrim and Diode Correction Toffset	88

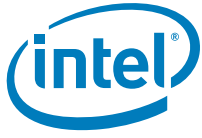



1	Package-Level Low-Power States	11
2	Core Low-Power States	12
3	4-MB and Fused 2-MB Micro-FCPGA Processor Package Drawing (Sheet 1 of 2)	34
4	4-MB and Fused 2-MB Micro-FCPGA Processor Package Drawing (Sheet 2 of 2)	35
5	2-MB Micro-FCPGA Processor Package Drawing (Sheet 1 of 2).....	36
6	2-MB Micro-FCPGA Processor Package Drawing (Sheet 2 of 2).....	37
7	SFF (ULV DC) Die Micro-FCBGA Processor Package Drawing.....	38

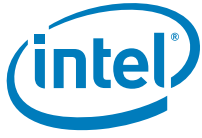



1	Introduction	7
1.1	Terminology	8
1.2	References	9
2	Low Power Features	11
2.1	Clock Control and Low Power States	11
2.1.1	Core Low-Power States	12
2.1.1.1	C0 State	12
2.1.1.2	C1/AutoHALT Powerdown State	12
2.1.1.3	C1/MWAIT Powerdown State	13
2.1.1.4	Core C2 State	13
2.1.1.5	Core C3 State	13
2.1.1.6	Core C4 State	13
2.1.2	Package Low-Power States	13
2.1.2.1	Normal State	13
2.1.2.2	Stop-Grant State	13
2.1.2.3	Stop Grant Snoop State	14
2.1.2.4	Sleep State	14
2.1.2.5	Deep Sleep State	15
2.1.2.6	Deeper Sleep State	15
2.2	Enhanced Intel SpeedStep® Technology	15
2.3	Low-Power FSB Features	16
2.4	Processor Power Status Indicator (PSI#) Signal	17
3	Electrical Specifications	19
3.1	Power and Ground Pins	19
3.2	FSB Clock (BCLK[1:0]) and Processor Clocking	19
3.3	Voltage Identification	19
3.4	Catastrophic Thermal Protection	22
3.5	Reserved and Unused Pins	22
3.6	FSB Frequency Select Signals (BSEL[2:0])	23
3.7	FSB Signal Groups	23
3.8	CMOS Signals	25
3.9	Maximum Ratings	25
3.10	Processor DC Specifications	26
4	Package Mechanical Specifications and Pin Information	33
4.1	Package Mechanical Specifications	33
4.2	Processor Pinout and Pin List	39
4.3	Alphabetical Signals Reference	75
5	Thermal Specifications and Design Considerations	83
5.1	Monitoring Die Temperature	84
5.1.1	Thermal Diode	85
5.1.2	Thermal Diode Offset	87
5.1.3	Intel® Thermal Monitor	88
5.1.4	Digital Thermal Sensor	89
5.1.5	Out of Specification Detection	90
5.1.6	PROCHOT# Signal Pin	90

