











Timer (Selection Guide)

Classification		GT3 Series Multi-function Timers				
		Multi-mode (Analog Setting)		OFF Delay (8-pin Terminal)	Star-Delta (8-pin Terminal)	Twin-Timer (8-pin Terminal)
		8-pin	With Inputs (11-pin)			
Part No. (Rated voltage code in □)		(1) GT3A-1 □ (2) GT3A-2 □ (3) GT3A-3 □	(4) GT3A-4 □ (5) GT3A-5 □ (6) GT3A-6 □	(1) GT3F-1 □ (2) GT3F-2 □	(1) GT3S-1 □ (2) GT3S-2 □	(1) GT3W-A □
Shape						
Operation System		Solid-state CMOS circuitry		Solid-state CMOS circuitry		
Operation Mode		ON Delay Interval ON Cycle Cycle ON	(4) ON Delay, Cycle, Signal ON/OFF Delay, Signal OFF Delay (5) Interval ON, One Shot Cycle, Signal ON/OFF Delay, Signal OFF Delay (6) One Shot, One Shot ON Delay, One Shot, Signal ON/OFF Delay	(1) Power OFF Delay (with reset input) (2) Power OFF Delay	Star-Delta	(1) Sequential Start, Coarse/Fine Adjustment, Instantaneous Cycle, Cycle Inversion, Interval ON, Interval ON Delay, Sequential Interval
Time Ranges		0.1 sec to 180 hours		0.1 sec to 600 sec	Star: 0.05 to 100 sec Star-Delta: 0.05 sec 0.1 sec 0.25 sec 0.5 sec	0.1 sec to 6 hours 0.1 sec to 300 hours
Contact		(1) Delayed SPDT (2) Delayed SPDT + Instantaneous SPDT (3) Delayed DPDT	Delayed DPDT (11-pin)	(1) Delayed SPDT (2) Delayed DPDT	(1) Delayed = Star:1NO, Delta:1NO (2) Delayed = Star:1NO, Delta:1NO Instantaneous = 1NO	Delayed SPDT + Delayed SPDT
Output		(1)(2) 240V AC, 3A 120V AC/30V DC, 5A (resistive load)	(3)(4)(5)(6) 240V AC/24V DC, 5A (resistive load)	(1) 250V AC/24V DC, 5A (resistive load) (2) 250V AC/24V DC, 3A (resistive load)	250V AC/30V DC, 5A (resistive load) 250V AC, 1.5A/30V DC, 2A (inductive load)	240V AC, 3A 120V AC/30V DC, 5A (resistive load)
Timing Accuracy	Repeat Error	±0.2%, ±10 ms (Note)		±0.2%, ±10 ms (Note)	±0.2%, ±10 ms (Note)	±0.2%, ±10 ms (Note)
	Setting Error	±10%		±10%	±10%	±10%
	Voltage Error	±0.2%, ±10 ms (Note)		±0.2%, ±10 ms (Note)	±0.2%, ±30 ms (Note)	±0.2%, ±10 ms (Note)
	Temperature Error	±0.2%, ±10 ms (Note)		±0.2%, ±10 ms (Note)	±0.2%, ±10 ms (Note)	±0.2%, ±10 ms (Note)
Reset Time		60 ms maximum		–	500 ms maximum	60 ms maximum
Rated Voltage		100 to 240V AC (50/60Hz) 24V AC (50/60Hz)/24V DC		100 to 240V AC (50/60Hz) 24V AC (50/60Hz)/24V DC	100 to 240V AC (50/60Hz)	100 to 240V AC (50/60Hz) 24V AC (50/60Hz)/24V DC
External Connection		<ul style="list-style-type: none"> Pin Terminals Socket (DIN rail mount screw terminal, panel mount screw terminal, solder terminal) Snap Mounting Adapter 				
Life	Mechanical	20,000,000 operations minimum		3,000,000 operations minimum	20,000,000 operations minimum	20,000,000 operations minimum
	Electrical	100,000 operations minimum		100,000 operations minimum	100,000 operations minimum	100,000 operations minimum
Input		–	No-voltage contact inputs/Transistor inputs 24V DC, 1 mA maximum	(1) No-voltage contact inputs/Transistor 6V DC, 0.6 mA maximum	–	–
Power Consumption (Approx.)		4.0VA (Delayed DPDT, 200V AC, 60Hz) 0.7W (Delayed DPDT, 24V DC)		2.3VA (100V AC, 60Hz) 0.2W (24V DC)	4.0VA (200V AC, 60Hz)	5.1VA (200V AC, 60Hz) 0.9W (24V DC)
Operating Temperature		–10 to +50°C (no freezing)				
Operating Humidity		35 to 85% RH (no condensation)				
Storage Temperature		–30 to +70°C (no freezing)				
Storage Humidity		35 to 85% RH (no condensation)				
Dimensions (Body)(mm)		40H × 36W × 72.2D		40H × 36W × 72.2D	40H × 36W × 72.2D	40H × 36W × 70D
Weight (Approx.)		(1)63g (2)73g (3)79g 80g		(1)77g (2)79g	(1)68g (2)75g	73g
Standards		UL, c-UL, CE		UL, c-UL, CE	UL, c-UL, CE	UL, c-UL, CE
Page		5		7	11	13
Page		5		7	11	13

Note: The largest value becomes the error against a preset value depending on the time range.

Timer (Selection Guide)



GT5 Series Miniature Electronic Timers	
GT5Y (Solder Terminal)	GT5P (8-pin Terminal)
(1) GT5Y-2S [*] (2) GT5Y-4S [*] Operation mode, time range, and rated voltage code in [*]	(1) GT5P [*] Operation mode, time range, and rated voltage code in [*]
	
RC oscillator	
(1)(2) ON Delay, Interval, or Cycle available on both types	ON Delay, Cycle, or One Shot available
<ul style="list-style-type: none"> On Delay: 0.1 sec to 60 min Interval: 0.1 sec to 10 min Cycle: 0.1 sec to 10 min 	<ul style="list-style-type: none"> On Delay: 0.1 sec to 10 min Cycle: 0.1 sec to 10 sec One Shot: 0.1 sec to 10 sec
(1) Delayed DPDT (2) Delayed 4PDT	Delayed SPDT
(1) 220V AC/30V DC, 5A (resistive load) (2) 220V AC/30V DC, 3A (resistive load)	240V AC, 3A 120V AC/30V DC, 5A (resistive load)
±0.2%, ±20 ms (Note)	±0.2%, ±10 ms (Note)
±10% maximum	±10% maximum
±0.5%, ±20 ms (Note)	±0.5%, ±20 ms (Note)
±3% maximum	±3% maximum
100 ms maximum	100 ms maximum
100 to 120V AC, 200 to 240V AC (50/60Hz), 12/24V DC	100 to 120V AC, 200 to 240V AC (50/60Hz), 12V DC, 24V AC (50/60Hz)
<ul style="list-style-type: none"> Solder Terminal Socket { DIN Rail Mount Screw Terminal Panel Mount Solder PC Board Terminal 	<ul style="list-style-type: none"> Pin Terminal Socket { DIN Rail Mount Screw Terminal Panel Mount Solder Wrapping Terminal
50,000,000 operations minimum	20,000,000 operations minimum
(1) 500,000 operations minimum (2) 200,000 operations minimum	100,000 operations minimum
-	-
1.6VA (100V AC, 60Hz) 1.4VA (200V AC, 60Hz) 1.0W (24V DC)	<ul style="list-style-type: none"> Excluding One Shot 2.3VA (100V AC, 60Hz) 3.9VA (200V AC, 60Hz) 0.5W (24V DC)
-10 to +50°C (no freezing)	-10 to +50°C (no freezing)
35 to 85% RH (no condensation)	35 to 85% RH (no condensation)
-30 to +80°C (no freezing)	-30 to +70°C (no freezing)
35 to 85% RH (no condensation)	35 to 85% RH (no condensation)
27.5H × 21W × 58.6D	36H × 29W × 69D
50g	49g
UL, c-UL, CE	UL, CSA, CE
23	25

GE1A Series Electronic Timers	
GE1A-B	GE1A-C
4 different time ranges	
GE1A①②③	GE1A①②③
①Contact code ②Time range code ③Rated voltage code	①Contact code ②Time range code ③Rated voltage code
	
RC oscillator	
ON delay (Instantaneous contact)	ON delay
10H (0.1 min to 10 hours) 30H (0.3 min to 30 hours)	
Delayed + Instantaneous	Delayed
240V AC/5A, 24V DC/5A (resistive load)	
±0.2% ±10 ms maximum	
±10% maximum	
±0.5% ±10 ms maximum	
±3% maximum	
100 ms minimum	
100 to 110V AC, 200 to 200V AC, 220 to 240V AC, 24V AC/DC	
<ul style="list-style-type: none"> Octal Pin Terminal Socket (Din rail mount socket, Panel mount socket, PC board mount socket) 	
GE1A-B: 10,000,000 operations minimum GE1A-C: 5,000,000 operations minimum	
100,000 operations minimum	
-	
7.7 VA, 6.6 VA (220V AC, 60/50Hz) 7.0 VA, 6.0 VA (200V AC, 60/50Hz) 3.8 VA, 3.3 VA (110V AC, 60/50Hz) 3.5 VA, 3.0 VA (100V AC, 60/50Hz) 1.6 VA/1.0W (24V AC/DC)	8.0 VA, 7.0 VA (220V AC, 60/50Hz) 8.0 VA, 7.0 VA (200V AC, 60/50Hz) 3.5 VA, 3.0 VA (110V AC, 60/50Hz) 3.5 VA, 3.0 VA (100V AC, 60/50Hz) 2.0 VA/ 0.8W (24V AC/DC)
-	
-	
-	
-	
48H × 48W × 95.2D	
101g	95g
UL, c-UL, TÜV, CE	
30	

GT3 series Multi-function Timers

Wide Variety Including OFF Delay and Star-Delta

- Universal AC power voltage 100 to 240V AC
- Solid-state CMOS circuitry ensures high accuracy
- Easy-to-view operation indicator
- DIN 48mm square panel mount adapter for snap mounting
- Complies with safety standards. UL/c-UL listed.
- Complies with EN standard

Applicable Standards	Mark	File No. or Organization
UL508 CSA C22.2 No.14		UL/c-UL Listed File No. E55996
EN61812-1		EU Low Voltage Directive

[Multi-mode]

- Instantaneous operation at zero setting
- Multi-mode, and universal AC power voltage cover 96 types by one timer



Multi-Mode (Analog Setting)

For details, see pages 5 to 10.

Operation Mode	Model	Contact	Time Range	Output	Operating Voltage	Part No.
On Delay Interval ON Cycle OFF Cycle ON	GT3A-1	Delayed SPDT	0.1 sec to 180 hours	240V AC, 3A 120V AC/ 30V DC, 5A	100 to 240V AC	GT3A-1AF20
	GT3A-2	Delayed SPDT + Instantaneous SPDT			100 to 240V AC	GT3A-2AF20
					24V AC/24V DC	GT3A-2AD24
GT3A-3	Delayed DPDT	240V AC/ 24V DC, 5A	100 to 240V AC	GT3A-3AF20		
ON Delay Cycle Signal ON/OFF Delay Signal OFF Delay	With Input	GT3A-4	0.1 sec to 180 hours	240V AC/ 24V DC, 5A	100 to 240V AC	GT3A-4AF20
					24V AC/24V DC	GT3A-4AD24
Interval ON One Shot Cycle Signal ON/OFF Delay Signal OFF Delay	With Input	GT3A-5	0.1 sec to 180 hours	240V AC/ 24V DC, 5A	100 to 240V AC	GT3A-5AF20
					24V AC/24V DC	GT3A-5AD24
One Shot One Shot ON Delay One Shot Signal ON/OFF Delay	With Input	GT3A-6	0.1 sec to 180 hours	240V AC/ 24V DC, 5A	100 to 240V AC	GT3A-6AF20
					24V AC/24V DC	GT3A-6AD24

OFF Delay

For details, see pages 11 to 12.

Operation Mode	Model	Contact	Time Range	Output	Operating Voltage	Part No.
Power OFF Delay	With Reset Input	GT3F-1	0.1 sec to 600 sec	250V AC/ 24V DC, 5A	100 to 240V AC	GT3F-1AF20
					24V AC/24V DC	GT3F-1AD24
Power OFF Delay	Without Reset Input	GT3F-2	0.1 sec to 600 sec	250V AC/ 24V DC, 3A	100 to 240V AC	GT3F-2AF20
					24V AC/24V DC	GT3F-2AD24

Star-Delta

For details, see pages 13 to 14.

Operation Mode	Model	Contact	Time Range	Output	Operating Voltage	Part No.
Star-Delta	GT3S-1	Delayed Star: SPST-NO Delta: SPST-NO	Star: 0.05 to 100 sec Star-Delta: 0.05 sec	250V AC/ 30V DC, 5A	100 to 240V AC	GT3S-1AF20
	GT3S-2	Delayed Star: SPST-NO Delta: SPST-NO Instantaneous: SPST-NO	0.1 sec 0.25 sec 0.5 sec			GT3S-2AF20

Twin-Timer

For details, see pages 15 to 16.

Operation Mode	Model	Contact	Time Range	Output	Operating Voltage	Part No.
Serial Activation Coarse/Fine Adjust- ment Setting Instantaneous Cycle Cycle Cycle Inversion Interval ON Interval ON Delay Serial Interval ON	GT3W-A	Delayed SPDT + Delayed SPDT	T1: 0.1 sec to 6 hours T2: 0.1 sec to 6 hours	240V AC, 3A	100 to 240V AC	GT3W-A11AF20N
					24V AC/24V DC	GT3W-A11AD24N
			T1: 0.1 sec to 6 hours T2: 0.1 sec to 300 hours		100 to 240V AC	GT3W-A13AF20N
					24V AC/24V DC	GT3W-A13AD24N
			T1: 0.1 sec to 300 hours T2: 0.1 sec to 6 hours		100 to 240V AC	GT3W-A31AF20N
					24V AC/24V DC	GT3W-A31AD24N
T1: 0.1 sec to 300 hours T2: 0.1 sec to 300 hours	100 to 240V AC	GT3W-A33AF20N				
24V AC/24V DC	GT3W-A33AD24N					

GT3 Series Multi-Mode (Analog Setting)

GT3A-1, -2, -3 (8-Pin)

Four Selectable Operation Modes in One Timer: ON Delay, Interval ON, Cycle, Cycle ON

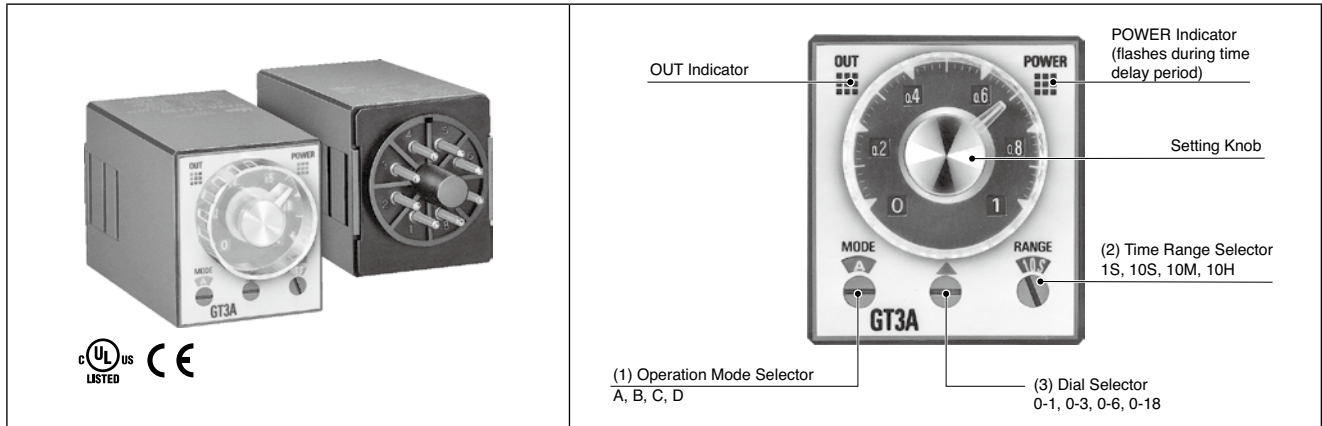

(1) Operation Mode	Rated Voltage	Time Ranges	Output	Contact	Part No.
A: ON Delay B: Interval ON C: Cycle OFF D: Cycle ON	100 to 240V AC	0.1 sec to 180 hours See Time Ranges for details.	240V AC, 3A 120V AC/30V DC, 5A (resistive load)	Delayed SPDT	GT3A-1AF20
	100 to 240V AC			Delayed SPDT + Instantaneous SPDT	GT3A-2AF20
	24V AC/24V DC		240V AC/24V DC, 5A (resistive load)	Delayed DPDT	GT3A-2AD24
	100 to 240V AC				GT3A-3AF20
	24V AC/24V DC			GT3A-3AD24	

Time Ranges

(2) Range	(3) Dial			
	0 - 1	0 - 3	0 - 6	0 - 18
1S	0.1 sec to 1 sec	0.1 sec to 3 sec	0.1 sec to 6 sec	0.2 sec to 18 sec
10S	0.1 sec to 10 sec	0.3 sec to 30 sec	0.6 sec to 60 sec	1.8 sec to 180 sec
10M	6 sec to 10 min	18 sec to 30 min	36 sec to 60 min	108 sec to 180 min
10H	6 min to 10 hours	18 min to 30 hours	36 min to 60 hours	108 min to 180 hours

Contact Ratings

Model	GT3A-1, GT3A-2	GT3A-3
Rated Load	240V AC, 3A (resistive load) 120V AC/30V DC, 5A (resistive load)	240V AC/24V DC, 5A (resistive load)
Maximum Switching Power	AC: 960VA DC: 120W	AC: 1200VA DC: 120W
Maximum Switching Voltage	250V AC/150V DC	
Maximum Switching Current	5A	
Maximum Switching Frequency	600 operations/hour	600 operations/hour
Minimum Applicable Load	5V DC, 10 mA (reference value)	
External Protection Element	Fuse 250V, 5A	
Life	Electrical	100,000 operations minimum (rated load)
	Mechanical	20,000,000 operations minimum

General Specifications

Model	GT3A-1	GT3A-2	GT3A-3		
Operation System	Solid-state CMOS circuitry				
Operation	Multi-Mode				
Time Range	0.1 sec to 180 hours				
Pollution Degree	2 (IEC60664-1)				
Overvoltage Category	III (IEC60664-1)				
Rated Voltage	AF20	100 to 240V AC (50/60Hz)			
	AD24	24V AC (50/60Hz)/24V DC			
Voltage Range	AF20	85 to 264V AC (50/60Hz)			
	AD24	20.4 to 26.4V AC (50/60Hz)/21.6 to 26.4V DC			
Reset Voltage	Rated voltage × 10% minimum				
Operating Temperature	-10 to +50°C (no freezing)				
Storage Temperature	-30 to +70°C (no freezing)				
Operating Humidity	35 to 85% RH (no condensation)				
Storage Humidity	35 to 85% RH (no condensation)				
Altitude	0 to 2000m (operation) 0 to 3000m (transportation)				
Reset Time	60 ms maximum				
Repeat Error	±0.2%, ±10 ms maximum (Note)				
Voltage Error	±0.2%, ±10 ms maximum (Note)				
Temperature Error	±0.2%, ±10 ms maximum (Note)				
Setting Error	±10% maximum				
Insulation Resistance	100 MΩ minimum (500V DC megger)				
Dielectric Strength	Between power and output terminals: 2000V AC, 1 minute				
	Between contacts of different poles: 2000V AC, 1 minute				
	Between contacts of the same pole: 750V AC, 1 minute (GT3A-1, 2) 1000V AC, 1 minute (GT3A-3)				
Vibration Resistance	GT3A-1/-2/-3: Damage limits: 10 to 55 Hz, amplitude 0.75mm, 2 hours each in 3 directions				
	GT3A-1/-2: Operating extremes: 10 to 55 Hz, amplitude 0.75mm, 2 hours each in 3 directions GT3A-3: Operating extremes: 10 to 55 Hz, amplitude 0.41mm, 2 hours each in 3 directions				
Shock Resistance	Operating extremes: 98 m/s ² , Damage limits: 490 m/s ² , 3 shocks each in 6 directions				
Degree of Protection	IP40 (timer), IP20 (socket) (IEC60529)				
Power Consumption (approx.)	AF20	100V AC 60Hz	2.9VA	2.5VA	2.2VA
		200V AC 60Hz	4.7VA	4.3VA	4.0VA
	AD24 (AC/DC)	1.3VA/0.5W	2.0VA/0.8W	1.8VA/0.7W	
Dimensions	40H × 36W × 72.2D mm				
Weight (approx.)	63g	73g	79g		

Note: The largest value becomes the error against a preset value depending on the time range.

GT3 Series Multi-Mode (Analog Setting)

Operation Chart

		Operation Chart									
Part No.		GT3A-1 <input type="checkbox"/>			GT3A-2 <input type="checkbox"/>			GT3A-3 <input type="checkbox"/>			
Contact		Delayed SPDT			Delayed SPDT + Instantaneous SPDT			Delayed DPDT			
Internal Connection											
Operation Mode Selection											
On Delay MODE A Set timer for desired delay, apply power to coil. Contacts transfer after preset time has elapsed, and remain in transferred position until timer is reset. Reset occurs with removal of power.	Item	Terminal No.	Operation								
	Power	2-7									
	Delayed Contact	5-8 (NC) 6-8 (NO)									
	Indicator	POWER OUT									
Interval ON MODE B Set timer for desired delay, apply power to coil. Contacts transfer immediately, and return to original position after preset time has elapsed. Reset occurs with removal of power.	Item	Terminal No.	Operation								
	Power	2-7									
	Delayed Contact	5-8 (NC) 6-8 (NO)									
	Indicator	POWER OUT									
Cycle OFF (OFF start) MODE C Set timer for desired delay, apply power to coil. First transfer of contacts occurs after preset delay has elapsed, after the next elapse of preset delay contacts return to original position. The timer now cycles between on and off as long as power is applied. The ratio is 1:1. Time Off = Time On	Item	Terminal No.	Operation								
	Power	2-7									
	Delayed Contact	5-8 (NC) 6-8 (NO)									
	Indicator	POWER OUT									
Cycle ON (ON start) MODE D Functions in same manner as Mode C, with the exception that first transfer of contacts occurs as soon as power is applied. The ratio is 1:1. Time Off = Time On	Item	Terminal No.	Operation								
	Power	2-7									
	Delayed Contact	5-8 (NC) 6-8 (NO)									
	Indicator	POWER OUT									

GT3 Series Multi-Mode (Analog Setting)

GT3A-4, -5, -6 (11-Pin)

Four Selectable Operation Modes with Start, Gate, and Reset Inputs for External Control

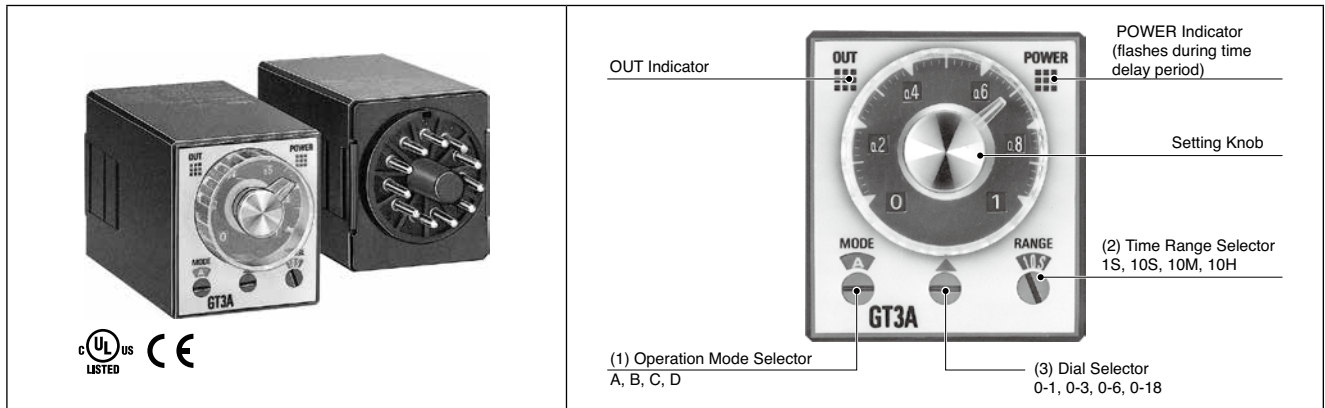

(1) Operation Mode	Rated Voltage Code	Time Ranges	Output	Contact	Input	Part No.
A: ON Delay B: Cycle OFF C: Signal ON Delay D: Signal OFF Delay	100 to 240V AC	0.1 sec to 180 hours See Time Ranges for details	240V AC, 5A 24V DC, 5A (resistive load)	Delayed DPDT	Start Reset Gate	GT3A-4AF20
	24V AC/24V DC					GT3A-4AD24
A: Interval ON B: One-Shot Cycle, C: Signal ON/OFF Delay D: Signal OFF Delay	100 to 240V AC					GT3A-5AF20
	24V AC/24V DC					GT3A-5AD24
A: One-Shot B: One-Shot ON Delay C: One-Shot D: Signal ON/OFF Delay	100 to 240V AC					GT3A-6AF20
	24V AC/24V DC					GT3A-6AD24

Time Ranges

(2) Range	(3) Dial			
	0 - 1	0 - 3	0 - 6	0 - 18
1S	0.1 sec to 1 sec	0.1 sec to 3 sec	0.1 sec to 6 sec	0.2 sec to 18 sec
10S	0.1 sec to 10 sec	0.3 sec to 30 sec	0.6 sec to 60 sec	1.8 sec to 180 sec
10M	6 sec to 10 min	18 sec to 30 min	36 sec to 60 min	108 sec to 180 min
10H	6 min to 10 hours	18 min to 30 hours	36 min to 60 hours	108 min to 180 hours

Contact Ratings

Rated Load	240V AC/24V DC, 5A (resistive load)	
Maximum Switching Power	AC: 1200VA DC: 120W	
Maximum Switching Voltage	250V AC/150V DC	
Maximum Switching Current	5A	
Maximum Switching Frequency	600 operations/hour	
Minimum Applicable Load	5V DC, 10 mA (reference value)	
External Protection Element	Fuse 250V, 5A	
Life	Electrical	100,000 operations minimum (rated load)
	Mechanical	20,000,000 operations minimum

Input Specifications

Start Input	The start input initiates delayed operation and controls output status.	No-voltage contact inputs and NPN open collector transistor inputs are applicable. 24V DC, 1 mA maximum Input response time: 50 ms maximum
Reset Input	When the reset input goes on (L level), the timer is reset to the original time (time at power-on).	
Gate Input	The time delay operation is suspended while the gate input is on (L level).	

General Specifications

Operation System	Solid-state CMOS circuitry	
Operation	Multi-mode with inputs (11 pins)	
Time Range	0.1 sec to 180 hours	
Pollution Degree	2 (IEC60664-1)	
Overvoltage Category	III (IEC60664-1)	
Rated Voltage	AF20	100 to 240V AC (50/60Hz)
	AD24	24V AC (50/60Hz)/24V DC
Voltage Range	AF20	85 to 264V AC (50/60Hz)
	AD24	20.4 to 26.4V AC (50/60Hz)/21.6 to 26.4V DC
Reset Voltage	Rated voltage × 10% minimum	
Operating Temperature	-10 to +50°C (no freezing)	
Storage Temperature	-30 to +70°C (no freezing)	
Operating Humidity	35 to 85% RH (no condensation)	
Storage Humidity	35 to 85% RH (no condensation)	
Altitude	0 to 2000m (operation) 0 to 3000m (transportation)	
Reset Time	60 ms maximum	
Repeat Error	±0.2%, ±10 ms (Note)	
Voltage Error	±0.2%, ±10 ms (Note)	
Temperature Error	±0.2%, ±10 ms (Note)	
Setting Error	±10% maximum	
Insulation Resistance	100MΩ minimum (500V DC megger)	
Dielectric Strength	Between power and output terminals: 2000V AC, 1 minute	
	Between contacts of different poles: 2000V AC, 1 minute	
	Between contacts of the same pole: 1000V AC, 1 minute	
Vibration Resistance	Damage Limits: 10 to 55 Hz, amplitude 0.75 mm, 2 hours each in 3 directions Operating extremes: 10 to 55 Hz, amplitude 0.41mm, 2 hour each in 3 directions	
Shock Resistance	Operating extremes: 98 m/s ² Damage limits: 490 m/s ² 3 shocks each in 6 directions	
Degree of Protection	IP40 (timer), IP20 (socket) (IEC60529)	
Power Consumption (Approx.)	AF20	2.2VA (100V AC/60Hz), 4.1VA (200V AC/60Hz)
	AD24	1.8VA (AC)/0.7W (DC)
Dimensions	40H × 36W × 72.2D mm	
Weight (approx.)	80g	

Note: The largest value becomes the error against a preset value depending on the time range.

GT3 Series Multi-Mode (Analog Setting)

Operation Chart





GT3A-4

Note: While the gate input is on during time delay operation, the POWER indicator flashing slows down.

Contact		Operation Chart	
Internal Connection		Delayed DPDT	
<p>Operation Mode Selection</p> <p>On Delay</p> <p>MODE A</p> <p>Power is applied to timer at all times. Set time for desired delay. When start input is supplied time delay starts, contacts transfer after preset time has elapsed. Contacts remain in transferred position until timer is reset.</p>		<p>Note: T = Set time Ta = Shorter than set time T = T' + T''</p>	
<p>Cycle</p> <p>MODE B</p> <p>Power is applied to timer at all times. Set timer for desired delay, initiate start input. Contacts transfer after preset time has elapsed and remain in transferred position until preset time elapses a second time. The timer will now continue to cycle in above manner until reset applied.</p>		<p>Operation</p> <p>Item Terminal No. Operation</p> <p>Power 2-10</p> <p>Input Start 6-2 ON or L</p> <p>Reset 7-2 ON or L</p> <p>Gate 5-2 ON or L</p> <p>Delayed Contact 4-1 8-11 (NC) 3-1 9-11 (NO)</p> <p>Indicator POWER OUT</p> <p>Set Time</p>	
<p>Signal ON/OFF Delay</p> <p>MODE C</p> <p>For this mode a maintained pushbutton is required for start input. Power is applied to timer at all times. Set timer for desired delay, initiate start input. Contacts will transfer immediately. After preset time (with start input still present) contacts will transfer back to original position. Remove start signal, at this time contacts will again transfer. Contacts will transfer to original position after preset time. Timer is reset by initiation of reset input.</p>		<p>Operation</p> <p>Item Terminal No. Operation</p> <p>Power 2-10</p> <p>Input Start 6-2 ON or L</p> <p>Reset 7-2 ON or L</p> <p>Gate 5-2 ON or L</p> <p>Delayed Contact 4-1 8-11 (NC) 3-1 9-11 (NO)</p> <p>Indicator POWER OUT</p> <p>Set Time</p>	
<p>Signal OFF Delay</p> <p>MODE D</p> <p>Power is applied to timer at all times. Set timer for desired delay, initiate start input. Contacts immediately transfer. When start input is removed time delay starts. After preset time contacts transfer back to original position. Timer is reset by initiation of reset input.</p>		<p>Operation</p> <p>Item Terminal No. Operation</p> <p>Power 2-10</p> <p>Input Start 6-2 ON or L</p> <p>Reset 7-2 ON or L</p> <p>Gate 5-2 ON or L</p> <p>Delayed Contact 4-1 8-11 (NC) 3-1 9-11 (NO)</p> <p>Indicator POWER OUT</p> <p>Set Time</p>	

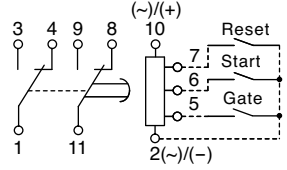
GT3 Series Multi-Mode (Analog Setting)

GT3A-5

Contact		Internal Connection		Operation Chart																													
Operation Mode Selection Interval ON  MODE A		Delayed DPDT 		Note: T = Set time Ta = Shorter than set time T = T' + T''																													
		<table border="1"> <thead> <tr> <th>Item</th> <th>Terminal No.</th> <th>Operation</th> </tr> </thead> <tbody> <tr> <td>Power</td> <td>2-10</td> <td>[Continuous high signal]</td> </tr> <tr> <td rowspan="3">Input</td> <td>Start</td> <td>6-2 ON or L</td> </tr> <tr> <td>Reset</td> <td>7-2 ON or L</td> </tr> <tr> <td>Gate</td> <td>5-2 ON or L</td> </tr> <tr> <td rowspan="3">Delayed Contact</td> <td>4-1 (NC)</td> <td>[High during delay]</td> </tr> <tr> <td>8-11 (NC)</td> <td>[High during delay]</td> </tr> <tr> <td>3-1 (NO)</td> <td>[Low during delay]</td> </tr> <tr> <td rowspan="2">Indicator</td> <td>POWER</td> <td>[Pulsed signal]</td> </tr> <tr> <td>OUT</td> <td>[Pulsed signal]</td> </tr> <tr> <td>Set Time</td> <td></td> <td>T, Ta, T', T''</td> </tr> </tbody> </table>		Item	Terminal No.	Operation	Power	2-10	[Continuous high signal]	Input	Start	6-2 ON or L	Reset	7-2 ON or L	Gate	5-2 ON or L	Delayed Contact	4-1 (NC)	[High during delay]	8-11 (NC)	[High during delay]	3-1 (NO)	[Low during delay]	Indicator	POWER	[Pulsed signal]	OUT	[Pulsed signal]	Set Time		T, Ta, T', T''		
Item	Terminal No.	Operation																															
Power	2-10	[Continuous high signal]																															
Input	Start	6-2 ON or L																															
	Reset	7-2 ON or L																															
	Gate	5-2 ON or L																															
Delayed Contact	4-1 (NC)	[High during delay]																															
	8-11 (NC)	[High during delay]																															
	3-1 (NO)	[Low during delay]																															
Indicator	POWER	[Pulsed signal]																															
	OUT	[Pulsed signal]																															
Set Time		T, Ta, T', T''																															
One-Shot Cycle  MODE B		<table border="1"> <thead> <tr> <th>Item</th> <th>Terminal No.</th> <th>Operation</th> </tr> </thead> <tbody> <tr> <td>Power</td> <td>2-10</td> <td>[Continuous high signal]</td> </tr> <tr> <td rowspan="3">Input</td> <td>Start</td> <td>6-2 ON or L</td> </tr> <tr> <td>Reset</td> <td>7-2 ON or L</td> </tr> <tr> <td>Gate</td> <td>5-2 ON or L</td> </tr> <tr> <td rowspan="3">Delayed Contact</td> <td>4-1 (NC)</td> <td>[High during delay]</td> </tr> <tr> <td>8-11 (NC)</td> <td>[High during delay]</td> </tr> <tr> <td>3-1 (NO)</td> <td>[Low during delay]</td> </tr> <tr> <td rowspan="2">Indicator</td> <td>POWER</td> <td>[Pulsed signal]</td> </tr> <tr> <td>OUT</td> <td>[Pulsed signal]</td> </tr> <tr> <td>Set Time</td> <td></td> <td>T, Ta, T', T''</td> </tr> </tbody> </table>		Item	Terminal No.	Operation	Power	2-10	[Continuous high signal]	Input	Start	6-2 ON or L	Reset	7-2 ON or L	Gate	5-2 ON or L	Delayed Contact	4-1 (NC)	[High during delay]	8-11 (NC)	[High during delay]	3-1 (NO)	[Low during delay]	Indicator	POWER	[Pulsed signal]	OUT	[Pulsed signal]	Set Time		T, Ta, T', T''		
		Item	Terminal No.	Operation																													
Power	2-10	[Continuous high signal]																															
Input	Start	6-2 ON or L																															
	Reset	7-2 ON or L																															
	Gate	5-2 ON or L																															
Delayed Contact	4-1 (NC)	[High during delay]																															
	8-11 (NC)	[High during delay]																															
	3-1 (NO)	[Low during delay]																															
Indicator	POWER	[Pulsed signal]																															
	OUT	[Pulsed signal]																															
Set Time		T, Ta, T', T''																															
Signal ON/OFF Delay  MODE C		<table border="1"> <thead> <tr> <th>Item</th> <th>Terminal No.</th> <th>Operation</th> </tr> </thead> <tbody> <tr> <td>Power</td> <td>2-10</td> <td>[Continuous high signal]</td> </tr> <tr> <td rowspan="3">Input</td> <td>Start</td> <td>6-2 ON or L</td> </tr> <tr> <td>Reset</td> <td>7-2 ON or L</td> </tr> <tr> <td>Gate</td> <td>5-2 ON or L</td> </tr> <tr> <td rowspan="3">Delayed Contact</td> <td>4-1 (NC)</td> <td>[High during delay]</td> </tr> <tr> <td>8-11 (NC)</td> <td>[High during delay]</td> </tr> <tr> <td>3-1 (NO)</td> <td>[Low during delay]</td> </tr> <tr> <td rowspan="2">Indicator</td> <td>POWER</td> <td>[Pulsed signal]</td> </tr> <tr> <td>OUT</td> <td>[Pulsed signal]</td> </tr> <tr> <td>Set Time</td> <td></td> <td>T, Ta, T', T''</td> </tr> </tbody> </table>		Item	Terminal No.	Operation	Power	2-10	[Continuous high signal]	Input	Start	6-2 ON or L	Reset	7-2 ON or L	Gate	5-2 ON or L	Delayed Contact	4-1 (NC)	[High during delay]	8-11 (NC)	[High during delay]	3-1 (NO)	[Low during delay]	Indicator	POWER	[Pulsed signal]	OUT	[Pulsed signal]	Set Time		T, Ta, T', T''		
		Item	Terminal No.	Operation																													
Power	2-10	[Continuous high signal]																															
Input	Start	6-2 ON or L																															
	Reset	7-2 ON or L																															
	Gate	5-2 ON or L																															
Delayed Contact	4-1 (NC)	[High during delay]																															
	8-11 (NC)	[High during delay]																															
	3-1 (NO)	[Low during delay]																															
Indicator	POWER	[Pulsed signal]																															
	OUT	[Pulsed signal]																															
Set Time		T, Ta, T', T''																															
Signal OFF Delay  MODE D		<table border="1"> <thead> <tr> <th>Item</th> <th>Terminal No.</th> <th>Operation</th> </tr> </thead> <tbody> <tr> <td>Power</td> <td>2-10</td> <td>[Continuous high signal]</td> </tr> <tr> <td rowspan="3">Input</td> <td>Start</td> <td>6-2 ON or L</td> </tr> <tr> <td>Reset</td> <td>7-2 ON or L</td> </tr> <tr> <td>Gate</td> <td>5-2 ON or L</td> </tr> <tr> <td rowspan="3">Delayed Contact</td> <td>4-1 (NC)</td> <td>[High during delay]</td> </tr> <tr> <td>8-11 (NC)</td> <td>[High during delay]</td> </tr> <tr> <td>3-1 (NO)</td> <td>[Low during delay]</td> </tr> <tr> <td rowspan="2">Indicator</td> <td>POWER</td> <td>[Pulsed signal]</td> </tr> <tr> <td>OUT</td> <td>[Pulsed signal]</td> </tr> <tr> <td>Set Time</td> <td></td> <td>T, Ta, T', T''</td> </tr> </tbody> </table>		Item	Terminal No.	Operation	Power	2-10	[Continuous high signal]	Input	Start	6-2 ON or L	Reset	7-2 ON or L	Gate	5-2 ON or L	Delayed Contact	4-1 (NC)	[High during delay]	8-11 (NC)	[High during delay]	3-1 (NO)	[Low during delay]	Indicator	POWER	[Pulsed signal]	OUT	[Pulsed signal]	Set Time		T, Ta, T', T''		
		Item	Terminal No.	Operation																													
Power	2-10	[Continuous high signal]																															
Input	Start	6-2 ON or L																															
	Reset	7-2 ON or L																															
	Gate	5-2 ON or L																															
Delayed Contact	4-1 (NC)	[High during delay]																															
	8-11 (NC)	[High during delay]																															
	3-1 (NO)	[Low during delay]																															
Indicator	POWER	[Pulsed signal]																															
	OUT	[Pulsed signal]																															
Set Time		T, Ta, T', T''																															

GT3 series Multi-Mode (Analog Setting)

GT3A-6

		Operation Chart		
Contact		Delayed DPDT		
Internal Connection				
Operation Mode Selection		<p>Note: T = Set time Ta = Shorter than set time T = T' + T''</p>		
One Shot Power is applied to timer at all times. Set timer for desired delay, initiate start input. Contacts immediately transfer. After preset time has elapsed contacts transfer back to original position. Reset occurs with initiation of reset input.	Item	Terminal No.	Operation	
	Power	2-10	[Timing diagram showing power applied throughout]	
	Input	Start	6-2 ON or L	[Timing diagram showing start pulses]
		Reset	7-2 ON or L	[Timing diagram showing reset pulses]
		Gate	5-2 ON or L	[Timing diagram showing gate pulses]
Delayed Contact	4-1 (NC) 8-11 (NO)		[Timing diagram showing contact states]	
	3-1 (NO) 9-11 (NO)		[Timing diagram showing contact states]	
Indicator	POWER		[Timing diagram showing power indicator pulses]	
	OUT		[Timing diagram showing output pulses]	
Set Time			[Timing diagram with labels Ta, T, T', T'']	
One Shot ON Delay Set timer for desired delay. When power is applied preset time begins and contacts transfer after preset time has elapsed (no start input needed at this time). Start input is now supplied, this causes the contacts to transfer back to original position. Contacts will remain in this position for preset time, after which they will transfer again. Contacts will now remain in this position until: reset, start input is applied again or power is removed.	Item	Terminal No.	Operation	
	Power	2-10	[Timing diagram showing power applied throughout]	
	Input	Start	6-2 ON or L	[Timing diagram showing start pulses]
		Reset	7-2 ON or L	[Timing diagram showing reset pulses]
		Gate	5-2 ON or L	[Timing diagram showing gate pulses]
Delayed Contact	4-1 (NC) 8-11 (NO)		[Timing diagram showing contact states]	
	3-1 (NO) 9-11 (NO)		[Timing diagram showing contact states]	
Indicator	POWER		[Timing diagram showing power indicator pulses]	
	OUT		[Timing diagram showing output pulses]	
Set Time			[Timing diagram with labels T, Ta, T', T'']	
One Shot Power is applied to timer at all times. Set timer for desired delay, initiate start input. Contacts immediately transfer. After preset time has elapsed contacts transfer back to original position. Reset occurs with initiation of reset input.	Item	Terminal No.	Operation	
	Power	2-10	[Timing diagram showing power applied throughout]	
	Input	Start	6-2 ON or L	[Timing diagram showing start pulses]
		Reset	7-2 ON or L	[Timing diagram showing reset pulses]
		Gate	5-2 ON or L	[Timing diagram showing gate pulses]
Delayed Contact	4-1 (NC) 8-11 (NO)		[Timing diagram showing contact states]	
	3-1 (NO) 9-11 (NO)		[Timing diagram showing contact states]	
Indicator	POWER		[Timing diagram showing power indicator pulses]	
	OUT		[Timing diagram showing output pulses]	
Set Time			[Timing diagram with labels T, Ta, T', T'']	
Signal ON/OFF Delay For this mode a maintained pushbutton is required for start input. Power is applied to timer at all times. Set timer for desired delay, initiate start input. Contacts will transfer immediately. After preset time (with start input still present) contacts will transfer back to original position. Remove start signal, at this time contacts will again transfer. Contacts will transfer to original position after preset time. Timer is reset by initiation of reset input.	Item	Terminal No.	Operation	
	Power	2-10	[Timing diagram showing power applied throughout]	
	Input	Start	6-2 ON or L	[Timing diagram showing start pulses]
		Reset	7-2 ON or L	[Timing diagram showing reset pulses]
		Gate	5-2 ON or L	[Timing diagram showing gate pulses]
Delayed Contact	4-1 (NC) 8-11 (NO)		[Timing diagram showing contact states]	
	3-1 (NO) 9-11 (NO)		[Timing diagram showing contact states]	
Indicator	POWER		[Timing diagram showing power indicator pulses]	
	OUT		[Timing diagram showing output pulses]	
Set Time			[Timing diagram with labels T, Ta, T', T'']	

GT3F-1/GT3F-2 (8-Pin)

Specifically designed for Power OFF Delay. Reset Inputs are available.

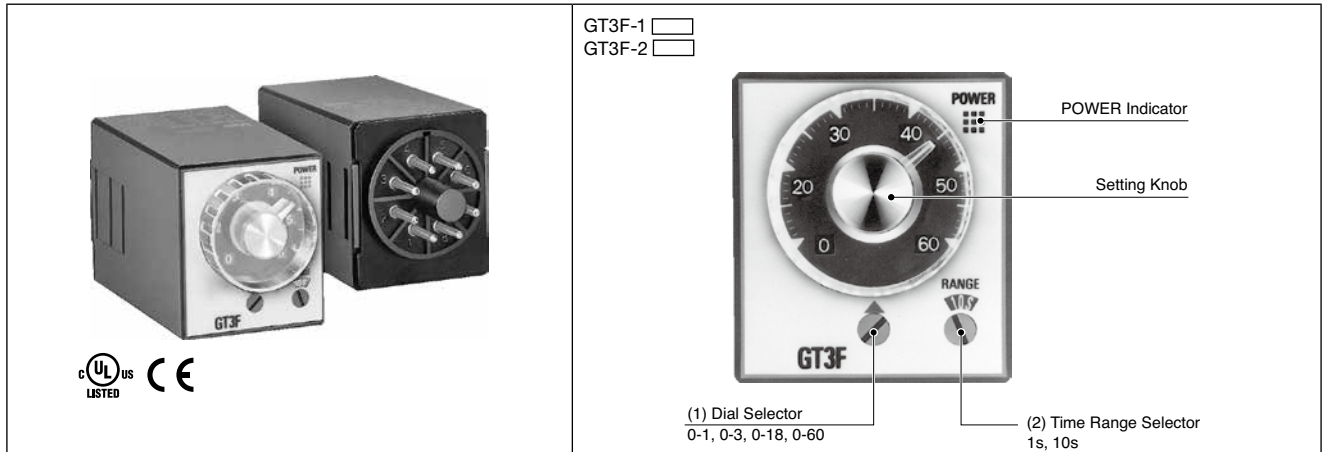

(1) Operation Mode	Rated Voltage Code	Time Ranges	Output	Contact	Input	Part No.
Power OFF Delay	100 to 240V AC	0.1 sec to 600 sec	250V AC/24V DC, 5A	Delayed SPDT	Reset	GT3F-1AF20
	24V AC/24V DC					GT3F-1AD24
	100 to 240V AC		250V AC/24V DC, 3A	Delayed DPDT	Without	GT3F-2AF20
	24V AC/24V DC					GT3F-2AD24

Time Ranges

GT3F-1/GT3F-2

(2) Range	(3) Dial			
	0 - 1	0 - 3	0 - 18	0 - 60
1S	0.1 sec to 1 sec	0.1 sec to 3 sec	0.2 sec to 18 sec	0.6 sec to 60 sec
10S	0.1 sec to 10 sec	0.3 sec to 30 sec	1.8 sec to 180 sec	6 sec to 600 sec

Timeout Repeat Cycle	3 sec minimum
Reset Input Repeat Cycle	3 sec minimum

Contact Ratings

Model	GT3F-1	GT3F-2
Rated Load	250V AC/24V DC, 5A (resistive load)	250V AC/24V DC, 3A (resistive load)
Minimum Switching Power	AC: 1250VA DC: 150W	AC: 750VA DC: 90W
Minimum Switching Voltage	250V AC/125V DC	
Minimum Switching Current	5A	3A
Maximum Switching Frequency	1800 operations/hour	
Minimum Applicable Load	5V DC, 10 mA	5V DC, 100 mA
External Protection Element	Fuse 250V, 5A	Fuse 250V, 3A
Life	Electrical	100,000 operations minimum (rated load)
	Mechanical	3,000,000 operations minimum

Input Specifications

Reset Input	The contact is reset by turning the reset input on (L level). No-voltage contact input and NPN open collector transistor input are applicable. 6V DC, 0.6 mA maximum Input Response Time (AC): ON: 50 ms maximum OFF: 1 sec maximum
-------------	---

General Specifications

Operation System	Solid-state CMOS circuitry	
Operation	Power OFF delay	
Time Range	0.1 sec to 600 hours	
Pollution Degree	2 (IEC60664-1)	
Overvoltage Category	III (IEC60664-1)	
Rated Voltage	AF20	100 to 240V AC (50/60Hz)
	AD24	24V AC (50/60Hz)/24V DC
Voltage Range	AF20	85 to 264V AC (50/60Hz)
	AD24	20.4 to 26.4V AC (50/60Hz)/21.6 to 26.4V DC
Time Delay Operation Start Voltage	Rated Voltage × 10% minimum	
Minimum Power Application Time (Note 1)	0.4 sec (time range: 180 sec or less) 1 sec (time range: 600 sec)	
Operating Temperature	-10 to +50°C (no freezing)	
Storage Temperature	-30 to +70°C (no freezing)	
Operating Humidity	35 to 85% RH (no condensation)	
Storage Humidity	35 to 85% RH (no condensation)	
Altitude	0 to 2000m (operation) 0 to 3000m (transportation)	
Repeat Error	±0.2%, ±10 ms (Note 2)	
Voltage Error	±0.2%, ±10 ms (Note 2)	
Temperature Error	±0.2%, ±10 ms (Note 2)	
Setting Error	±10%	
Insulation Resistance	100 MΩ min. (500V DC megger)	
Dielectric Strength	Between power and output terminals: 2000V AC, 1 minute	
	Between contacts of different poles: 2000V AC, 1 minute	
	Between contacts of the same pole: 1000V AC, 1 minute	
Vibration Resistance	Damage limits/operating extremes: 10 to 55Hz, amplitude 0.75 mm, 2 hours each in 3 directions	
Shock Resistance	Operating extremes: 98 m/s ² , Damage limits: 490 m/s ² , 3 shocks each in 6 directions	
Degree of Protection	IP40 (timer), IP20 (socket) (IEC60529)	
Power Consumption (approx.)	AF20	1.1 VA (100V AC/60Hz), 2.3 VA (200V AC/60Hz)
	AD24	0.7 VA (AC)/0.2W (DC)
Dimensions	40H × 36W × 72.2D mm	
Weight (approx.)	GT3F-1	GT3F-2
	77g	79g

Note 1: An inrush current flows during minimum power application time.
AF20: Approx. 0.4A, AD24: Approx. 1.2A

Note 2: The largest value becomes the error against a preset value depending on the time range.

GT3 Series Power OFF Delay

Operation Chart

Contact	Internal Connection	Operation Chart																				
GT3F-1 Delayed SPDT Output with Reset Input		<table border="1"> <thead> <tr> <th>Item</th> <th>Terminal No.</th> <th>Operation</th> </tr> </thead> <tbody> <tr> <td>Power</td> <td>2-7</td> <td></td> </tr> <tr> <td>Reset Input</td> <td>4-1 ON</td> <td></td> </tr> <tr> <td rowspan="2">Delayed Contact</td> <td>5-8 (NC)</td> <td></td> </tr> <tr> <td>6-8 (NO)</td> <td></td> </tr> <tr> <td>Indicator</td> <td>POWER</td> <td></td> </tr> <tr> <td>Set Time</td> <td></td> <td></td> </tr> </tbody> </table> <p> T = Set time Ta = Shorter than set time Ts = 1 sec Tr = Minimum power application time </p> <ul style="list-style-type: none"> • 0.4 sec (time range: 180 sec or less) • 1 sec (time range: 600 sec or less) • When power turns on, the NO output contact goes on. When a preset time has elapsed after the power has been turned off, the NO output contact goes off. • The contact is reset by turning the reset input on. 	Item	Terminal No.	Operation	Power	2-7		Reset Input	4-1 ON		Delayed Contact	5-8 (NC)		6-8 (NO)		Indicator	POWER		Set Time		
Item	Terminal No.	Operation																				
Power	2-7																					
Reset Input	4-1 ON																					
Delayed Contact	5-8 (NC)																					
	6-8 (NO)																					
Indicator	POWER																					
Set Time																						
GT3F-2 Delayed DPDT Output		<table border="1"> <thead> <tr> <th>Item</th> <th>Terminal No.</th> <th>Operation</th> </tr> </thead> <tbody> <tr> <td>Power</td> <td>2-7</td> <td></td> </tr> <tr> <td rowspan="2">Delayed Contact</td> <td>5-8, 4-1 (NC)</td> <td></td> </tr> <tr> <td>6-8, 3-1 (NO)</td> <td></td> </tr> <tr> <td>Indicator</td> <td>POWER</td> <td></td> </tr> <tr> <td>Set Time</td> <td></td> <td></td> </tr> </tbody> </table> <p> T = Set time Tr = Minimum power application time </p> <ul style="list-style-type: none"> • 0.4 sec (time range: 180 sec or less) • 1 sec (time range: 600 sec or less) • When power turns on, the NO output contact goes on. When a preset time has elapsed after the power has been turned off, the NO output contact goes off. 	Item	Terminal No.	Operation	Power	2-7		Delayed Contact	5-8, 4-1 (NC)		6-8, 3-1 (NO)		Indicator	POWER		Set Time					
Item	Terminal No.	Operation																				
Power	2-7																					
Delayed Contact	5-8, 4-1 (NC)																					
	6-8, 3-1 (NO)																					
Indicator	POWER																					
Set Time																						

GT3S-1/GT3S-2 (8-Pin)

Star-Delta Output Mode

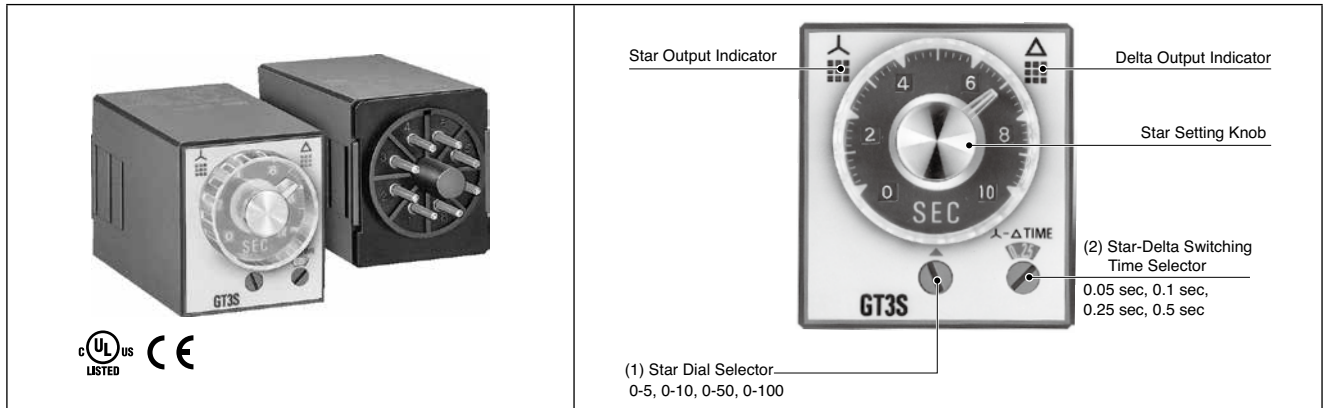

(1) Operation Mode	Rated Voltage	Time Range	Output	Contact	Part No.
Star-Delta	100 to 240V AC	Star: 0.05 to 100 sec Star-Delta switching time 0.05 sec 0.10 sec 0.25 sec 0.50 sec	250V AC/ 30V DC, 5A (resistive load)	Star: Delayed SPST-NO Delta: Delayed SPST-NO	GT3S-1AF20
				Star: Delayed SPST-NO Delta: Delayed SPST-NO Instantaneous SPST-NO	GT3S-2AF20

Time Ranges

① Star Dial Selector		② Star-Delta Switching Time Selector	
Dial	Time Range	Indication	Time
0 - 5	0.05 sec - 5 sec	0.05	0.05 sec
0 - 10	0.1 sec - 10 sec	0.1	0.1 sec
0 - 50	0.5 sec - 50 sec	0.25	0.25 sec
0 - 100	1 sec - 100 sec	0.5	0.5 sec

Contact Ratings

Rated Load	250V AC/30V DC, 5A (resistive load) 250V AC, 1.5A/30V DC, 2A (inductive load)
Maximum Switching Power	AC: 1250VA DC: 150W
Maximum Switching Voltage	250V AC/125V DC
Maximum Switching Current	5A
Maximum Switching Frequency	600 operations/hour
Minimum Applicable Load	5V DC, 100mA (reference value)
External Protection Element	Fuse 250V, 5A
Life	Electrical
	Mechanical
	100,000 operations minimum (rated load)
	20,000,000 operations minimum

General Specifications

Operation System	Solid-state CMOS circuitry	
Operation	Star-delta	
Time Range	Star side: 0.05 sec to 100 sec Star delta switching time: 0.05, 0.1, 0.25, 0.5 sec	
Pollution Degree	2 (IEC60664-1)	
Overvoltage Category	III (IEC60664-1)	
Rated Voltage	100 to 240V AC (50/60Hz)	
Voltage Range	85 to 264V AC (50/60Hz)	
Reset Voltage	Rated Voltage × 10% minimum	
Operating Temperature	-10 to +50°C (no freezing)	
Storage Temperature	-30 to +70°C (no freezing)	
Operating Humidity	35 to 85% RH (no condensation)	
Storage Humidity	35 to 85% RH (no condensation)	
Altitude	0 to 2000m (operation) 0 to 3000m (transportation)	
Reset Time	500 ms maximum	
Repeat Error	±0.2%, ±10 ms (Note)	
Voltage Error	±0.2%, ±30 ms (Note)	
Temperature Error	±0.2%, ±10 ms (Note)	
Setting Error	±10% maximum	
Insulation Resistance	100 MΩ minimum (500V DC megger)	
Dielectric Strength	Between power and output terminals: 2000V AC, 1 minute	
	Between contacts of different poles: 2000V AC, 1 minute	
	Between contacts of the same pole: 1000V AC, 1 minute	
Vibration Resistance	Damage limits/operating extremes: 10 to 55 Hz, amplitude 0.75 mm, 2 hours each in 3 directions	
Shock Resistance	Operating extremes: 98 m/s ² , Damage limits: 490 m/s ² , 3 shocks each in 6 directions	
Degree of Protection	IP40 (timer), IP20 (socket) (IEC60529)	
Power Consumption (approx.)	GT3S-1AF20	GT3S-2AF20
	2.3VA (100V AC/60Hz) 4.0VA (200V AC/60Hz)	2.3VA (100V AC/60Hz) 3.8VA (200V AC/60Hz)
Dimensions	40H × 36W × 72.2D mm	
Weight (approx.)	GT3S-1AF20	GT3S-2AF20
	68g	75g

Note: The largest value becomes the error against a preset value depending on the time range.

GT3 Series Star-Delta

Operation Chart

Contact	Internal Connection	Operation Chart																							
GT3S-1 Star : Delayed SPST-NO Delta: Delayed SPST-NO		<table border="1"> <thead> <tr> <th>Item</th> <th>Terminal No.</th> <th>Operation</th> </tr> </thead> <tbody> <tr> <td>Power</td> <td>2-7</td> <td>[Power pulse]</td> </tr> <tr> <td>Star Delayed Contact</td> <td>8-5 (NO)</td> <td>[Delayed pulse during T1]</td> </tr> <tr> <td>Delta Delayed Contact</td> <td>8-6 (NO)</td> <td>[Delayed pulse during T3]</td> </tr> <tr> <td rowspan="2">Indicator</td> <td>Star</td> <td>[Pulse during T1]</td> </tr> <tr> <td>Delta</td> <td>[Pulse during T3]</td> </tr> <tr> <td>Set Time</td> <td></td> <td>T1 T2 T3</td> </tr> </tbody> </table> <p>The star delayed contact goes on when power is turned on and goes off after a set time for the star contact (T_1).</p> <p>The delta contact goes on after star-delta switching time (T_2) and goes off when power is turned off.</p> <ul style="list-style-type: none"> • T_1 = Star ON time (Set Time), T_2 = Star-delta switching time, T_3 = Star ON time 	Item	Terminal No.	Operation	Power	2-7	[Power pulse]	Star Delayed Contact	8-5 (NO)	[Delayed pulse during T1]	Delta Delayed Contact	8-6 (NO)	[Delayed pulse during T3]	Indicator	Star	[Pulse during T1]	Delta	[Pulse during T3]	Set Time		T1 T2 T3			
Item	Terminal No.	Operation																							
Power	2-7	[Power pulse]																							
Star Delayed Contact	8-5 (NO)	[Delayed pulse during T1]																							
Delta Delayed Contact	8-6 (NO)	[Delayed pulse during T3]																							
Indicator	Star	[Pulse during T1]																							
	Delta	[Pulse during T3]																							
Set Time		T1 T2 T3																							
GT3S-2 Star : Delayed SPST-NO Delta: Delayed SPST-NO Instantaneous SPST-NO		<table border="1"> <thead> <tr> <th>Item</th> <th>Terminal No.</th> <th>Operation</th> </tr> </thead> <tbody> <tr> <td>Power</td> <td>2-7</td> <td>[Power pulse]</td> </tr> <tr> <td>Star Delayed Contact</td> <td>8-5 (NO)</td> <td>[Delayed pulse during T1]</td> </tr> <tr> <td>Delta Delayed Contact</td> <td>8-6 (NO)</td> <td>[Delayed pulse during T3]</td> </tr> <tr> <td>Instantaneous contact</td> <td>3-1 (NO)</td> <td>[Pulse during T1]</td> </tr> <tr> <td rowspan="2">Indicator</td> <td>Star</td> <td>[Pulse during T1]</td> </tr> <tr> <td>Delta</td> <td>[Pulse during T3]</td> </tr> <tr> <td>Set Time</td> <td></td> <td>T1 T2 T3</td> </tr> </tbody> </table> <p>The star delayed contact goes on when power is turned on and goes off after a set time for the star contact (T_1).</p> <p>The delta contact goes on after star-delta switching time (T_2) and goes off when power is turned off.</p> <p>Instantaneous contact goes on when power is turned on and goes off when power is turned off.</p> <ul style="list-style-type: none"> • T_1 = Star ON time (Set Time), T_2 = Star-delta switching time, T_3 = Star ON time 	Item	Terminal No.	Operation	Power	2-7	[Power pulse]	Star Delayed Contact	8-5 (NO)	[Delayed pulse during T1]	Delta Delayed Contact	8-6 (NO)	[Delayed pulse during T3]	Instantaneous contact	3-1 (NO)	[Pulse during T1]	Indicator	Star	[Pulse during T1]	Delta	[Pulse during T3]	Set Time		T1 T2 T3
Item	Terminal No.	Operation																							
Power	2-7	[Power pulse]																							
Star Delayed Contact	8-5 (NO)	[Delayed pulse during T1]																							
Delta Delayed Contact	8-6 (NO)	[Delayed pulse during T3]																							
Instantaneous contact	3-1 (NO)	[Pulse during T1]																							
Indicator	Star	[Pulse during T1]																							
	Delta	[Pulse during T3]																							
Set Time		T1 T2 T3																							

GT3W-A11, -A13, -A31, A33

Multi-range Twin-Timer with 8 operation modes

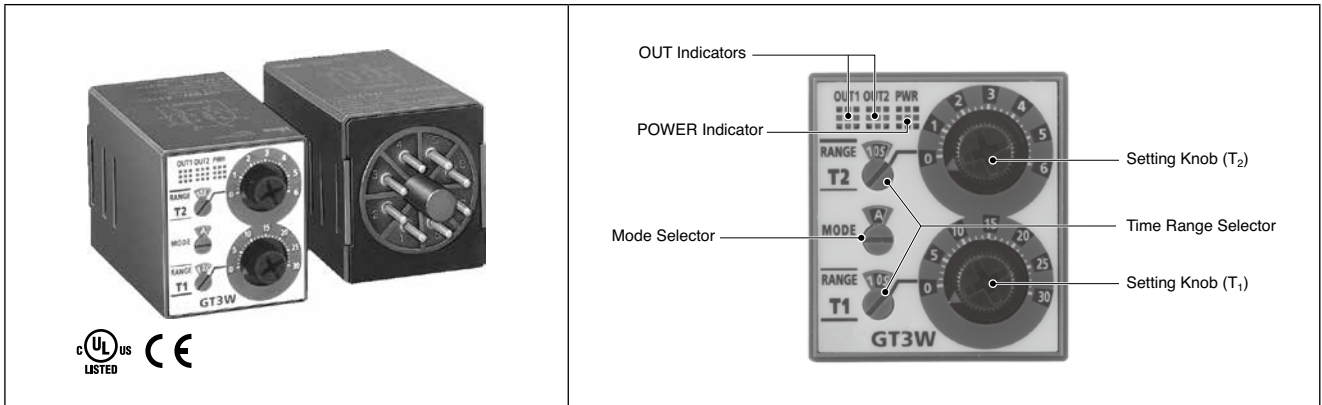

(1) Operation Mode	Rated Voltage	Time Ranges		Part No.
		T ₁	T ₂	
Sequential Start Coarse/Fine Adjustment Instantaneous Cycle	100 to 240V AC	0.1 sec to 6 hours	0.1 sec to 6 hours	GT3W-A11AF20N
	24V AC/24V DC		0.1 sec to 300 hours	GT3W-A11AD24N
Cycle Cycle Inversion	100 to 240V AC	0.1 sec to 300 hours	0.1 sec to 6 hours	GT3W-A13AF20N
	24V AC/24V DC		0.1 sec to 300 hours	GT3W-A13AD24N
Interval ON Interval ON Delay	100 to 240V AC	0.1 sec to 300 hours	0.1 sec to 6 hours	GT3W-A31AF20N
	24V AC/24V DC		0.1 sec to 300 hours	GT3W-A31AD24N
Sequential Interval	100 to 240V AC	0.1 sec to 300 hours	0.1 sec to 300 hours	GT3W-A33AF20N
	24V AC/24V DC		0.1 sec to 300 hours	GT3W-A33AD24N

Time Ranges

0.1 sec to 6 hours			0.1 sec to 300 hours		
Time Range Selector	Scale	Time Range	Time Range Selector	Scale	Time Range
1S	0 - 1	0.1 sec to 1 sec	1S	0 - 3	0.1 sec to 3 sec
10S		0.3 sec to 10 sec	1M		3.8 sec to 3 min
10M	0 - 6	15 sec to 10 min	1H	0 - 30	3.8 min to 3 hours
1S		0.1 sec to 6 sec	1S		0.6 sec to 30 sec
10S		1.3 sec to 60 sec	1M		38 sec to 30 min
1M		7.5 sec to 1 min	1H		38 min to 30 hours
10M	10H	75 sec to 60 min	10H	6.3 hours to 300 hours	
1H		7.5 min to 6 hours			

Contact Ratings

Rated Load	240V AC, 3A (resistive load) 120V AC/ 30V DC, 5A (resistive load)	
Maximum Switching Power	AC: 960VA DC: 120W	
Maximum Switching Voltage	250V AC/150V DC	
Maximum Switching Current	5A	
Maximum Switching Frequency	600 operations/hour	
Minimum Applicable Load	5V DC, 10mA (reference value)	
External Protection Element	Fuse 250V, 5A	
Life	Electrical	100,000 operations minimum (rated load)
	Mechanical	20,000,000 operations minimum

General Specifications

Operation System	Solid-state CMOS circuitry	
Operation	Multi-Mode	
Time Range	0.1 sec to 300 hours	
Pollution Degree	2 (IEC60664-1)	
Overvoltage Category	III (IEC60664-1)	
Rated Range	AF20	100 to 240V AC (50/60Hz)
	AD24	24V AC (50/60Hz)/ 24V DC
Voltage Range	AF20	85 to 264V AC (50/60Hz)
	AD24	20.4 to 26.4V AC (50/60Hz)/21.6 to 26.4V DC
Reset Voltage	Rated voltage × 10% minimum	
Operating Temperature	-10 to +50°C (no freezing)	
Storage Temperature	-30 to +70°C (no freezing)	
Operating Humidity	35 to 85% RH (no condensation)	
Storage Humidity	35 to 85% RH (no condensation)	
Altitude	0 to 2000m (operation) 0 to 3000m (transportation)	
Reset Time	60 ms maximum	
Repeat Error	±0.2%, ±10 ms (Note)	
Voltage Error	±0.2%, ±10 ms (Note)	
Temperature Error	±0.6%, ±10 ms (Note)	
Setting Error	±10%	
Insulation Resistance	100 MΩ minimum (500V DC megger)	
Dielectric Strength	Between power and output terminals: 2000V AC, 1 minute	
	Between contacts of different poles: 2000V AC, 1 minute	
	Between contacts of the same pole: 750V AC, 1 minute	
Vibration Resistance	Damage limits/operating extremes: 10 to 55Hz, amplitude 0.75 mm, 2 hours each in 3 directions	
Shock Resistance	Operating extremes: 98 m/s ²	
	Damage limits: 490 m/s ² 3 shocks each in 6 directions	
Degree of Protection	IP40 (timer), IP20 (socket) (IEC60529)	
Power Consumption (approx.)	AF20	2.6VA (100V AC /60Hz) 5.1VA (200V AC /60Hz)
	AD24	1.8VA (AC)/0.9W (DC)
Dimensions	40H × 36W × 70.0D mm	
Weight (approx.)	73g	

Note: The largest value becomes the error against a preset value depending on the time range.

GT3 Series Twin-Timer

Operation Chart

Operation Chart																									
Contact	Delayed SPDT + Delayed SPDT																								
Internal Connection																									
Operation Mode Selection																									
Sequential Start	<table border="1"> <thead> <tr> <th>Item</th> <th>Terminal No.</th> <th>Operation</th> <th>Description</th> </tr> </thead> <tbody> <tr> <td>Power</td> <td>2-7</td> <td>[Timing diagram: Power ON for duration T1 + T2]</td> <td></td> </tr> <tr> <td>Delayed Contact Ry1</td> <td>1-4 (NC) 1-3 (NO)</td> <td>[Timing diagram: Ry1 ON after T1]</td> <td>ON after T1</td> </tr> <tr> <td>Delayed Contact Ry2</td> <td>5-8 (NC) 6-8 (NO)</td> <td>[Timing diagram: Ry2 ON after T1 + T2]</td> <td>ON after T1 + T2</td> </tr> <tr> <td>Indicator</td> <td>OUT1 OUT2</td> <td>[Timing diagram: OUT1 and OUT2 pulses]</td> <td></td> </tr> <tr> <td>Set Time</td> <td></td> <td>T1 T2</td> <td></td> </tr> </tbody> </table>	Item	Terminal No.	Operation	Description	Power	2-7	[Timing diagram: Power ON for duration T1 + T2]		Delayed Contact Ry1	1-4 (NC) 1-3 (NO)	[Timing diagram: Ry1 ON after T1]	ON after T1	Delayed Contact Ry2	5-8 (NC) 6-8 (NO)	[Timing diagram: Ry2 ON after T1 + T2]	ON after T1 + T2	Indicator	OUT1 OUT2	[Timing diagram: OUT1 and OUT2 pulses]		Set Time		T1 T2	
	Item	Terminal No.	Operation	Description																					
	Power	2-7	[Timing diagram: Power ON for duration T1 + T2]																						
	Delayed Contact Ry1	1-4 (NC) 1-3 (NO)	[Timing diagram: Ry1 ON after T1]	ON after T1																					
	Delayed Contact Ry2	5-8 (NC) 6-8 (NO)	[Timing diagram: Ry2 ON after T1 + T2]	ON after T1 + T2																					
Indicator	OUT1 OUT2	[Timing diagram: OUT1 and OUT2 pulses]																							
Set Time		T1 T2																							
Coarse/Fine Adjustment	<table border="1"> <thead> <tr> <th>Item</th> <th>Terminal No.</th> <th>Operation</th> <th>Description</th> </tr> </thead> <tbody> <tr> <td>Power</td> <td>2-7</td> <td>[Timing diagram: Power ON for duration T1 + T2]</td> <td></td> </tr> <tr> <td>Delayed Contact Ry1</td> <td>1-4 (NC) 1-3 (NO)</td> <td>[Timing diagram: Ry1 ON after T1 + T2]</td> <td>ON after T1 + T2</td> </tr> <tr> <td>Delayed Contact Ry2</td> <td>5-8 (NC) 6-8 (NO)</td> <td>[Timing diagram: Ry2 ON after T1 + T2]</td> <td>ON after T1 + T2</td> </tr> <tr> <td>Indicator</td> <td>OUT1 OUT2</td> <td>[Timing diagram: OUT1 and OUT2 pulses]</td> <td></td> </tr> <tr> <td>Set Time</td> <td></td> <td>T1 T2</td> <td></td> </tr> </tbody> </table>	Item	Terminal No.	Operation	Description	Power	2-7	[Timing diagram: Power ON for duration T1 + T2]		Delayed Contact Ry1	1-4 (NC) 1-3 (NO)	[Timing diagram: Ry1 ON after T1 + T2]	ON after T1 + T2	Delayed Contact Ry2	5-8 (NC) 6-8 (NO)	[Timing diagram: Ry2 ON after T1 + T2]	ON after T1 + T2	Indicator	OUT1 OUT2	[Timing diagram: OUT1 and OUT2 pulses]		Set Time		T1 T2	
	Item	Terminal No.	Operation	Description																					
	Power	2-7	[Timing diagram: Power ON for duration T1 + T2]																						
	Delayed Contact Ry1	1-4 (NC) 1-3 (NO)	[Timing diagram: Ry1 ON after T1 + T2]	ON after T1 + T2																					
	Delayed Contact Ry2	5-8 (NC) 6-8 (NO)	[Timing diagram: Ry2 ON after T1 + T2]	ON after T1 + T2																					
Indicator	OUT1 OUT2	[Timing diagram: OUT1 and OUT2 pulses]																							
Set Time		T1 T2																							
Instantaneous Cycle	<table border="1"> <thead> <tr> <th>Item</th> <th>Terminal No.</th> <th>Operation</th> <th>Description</th> </tr> </thead> <tbody> <tr> <td>Power</td> <td>2-7</td> <td>[Timing diagram: Power ON for duration T1 + T2]</td> <td></td> </tr> <tr> <td>Delayed Contact Ry1</td> <td>1-4 (NC) 1-3 (NO)</td> <td>[Timing diagram: Ry1 Instantaneous ON]</td> <td>Instantaneous ON</td> </tr> <tr> <td>Delayed Contact Ry2</td> <td>5-8 (NC) 6-8 (NO)</td> <td>[Timing diagram: Ry2 OFF during T1, ON during T2]</td> <td>OFF during T1 ON during T2</td> </tr> <tr> <td>Indicator</td> <td>OUT1 OUT2</td> <td>[Timing diagram: OUT1 and OUT2 pulses]</td> <td></td> </tr> <tr> <td>Set Time</td> <td></td> <td>T1 T2 T1 T2</td> <td></td> </tr> </tbody> </table>	Item	Terminal No.	Operation	Description	Power	2-7	[Timing diagram: Power ON for duration T1 + T2]		Delayed Contact Ry1	1-4 (NC) 1-3 (NO)	[Timing diagram: Ry1 Instantaneous ON]	Instantaneous ON	Delayed Contact Ry2	5-8 (NC) 6-8 (NO)	[Timing diagram: Ry2 OFF during T1, ON during T2]	OFF during T1 ON during T2	Indicator	OUT1 OUT2	[Timing diagram: OUT1 and OUT2 pulses]		Set Time		T1 T2 T1 T2	
	Item	Terminal No.	Operation	Description																					
	Power	2-7	[Timing diagram: Power ON for duration T1 + T2]																						
	Delayed Contact Ry1	1-4 (NC) 1-3 (NO)	[Timing diagram: Ry1 Instantaneous ON]	Instantaneous ON																					
	Delayed Contact Ry2	5-8 (NC) 6-8 (NO)	[Timing diagram: Ry2 OFF during T1, ON during T2]	OFF during T1 ON during T2																					
Indicator	OUT1 OUT2	[Timing diagram: OUT1 and OUT2 pulses]																							
Set Time		T1 T2 T1 T2																							
Cycle	<table border="1"> <thead> <tr> <th>Item</th> <th>Terminal No.</th> <th>Operation</th> <th>Description</th> </tr> </thead> <tbody> <tr> <td>Power</td> <td>2-7</td> <td>[Timing diagram: Power ON for duration T1 + T2]</td> <td></td> </tr> <tr> <td>Delayed Contact Ry1</td> <td>1-4 (NC) 1-3 (NO)</td> <td>[Timing diagram: Ry1 OFF during T1, ON during T2]</td> <td>OFF during T1 ON during T2</td> </tr> <tr> <td>Delayed Contact Ry2</td> <td>5-8 (NC) 6-8 (NO)</td> <td>[Timing diagram: Ry2 OFF during T1, ON during T2]</td> <td>OFF during T1 ON during T2</td> </tr> <tr> <td>Indicator</td> <td>OUT1 OUT2</td> <td>[Timing diagram: OUT1 and OUT2 pulses]</td> <td></td> </tr> <tr> <td>Set Time</td> <td></td> <td>T1 T2 T1 T2</td> <td></td> </tr> </tbody> </table>	Item	Terminal No.	Operation	Description	Power	2-7	[Timing diagram: Power ON for duration T1 + T2]		Delayed Contact Ry1	1-4 (NC) 1-3 (NO)	[Timing diagram: Ry1 OFF during T1, ON during T2]	OFF during T1 ON during T2	Delayed Contact Ry2	5-8 (NC) 6-8 (NO)	[Timing diagram: Ry2 OFF during T1, ON during T2]	OFF during T1 ON during T2	Indicator	OUT1 OUT2	[Timing diagram: OUT1 and OUT2 pulses]		Set Time		T1 T2 T1 T2	
	Item	Terminal No.	Operation	Description																					
	Power	2-7	[Timing diagram: Power ON for duration T1 + T2]																						
	Delayed Contact Ry1	1-4 (NC) 1-3 (NO)	[Timing diagram: Ry1 OFF during T1, ON during T2]	OFF during T1 ON during T2																					
	Delayed Contact Ry2	5-8 (NC) 6-8 (NO)	[Timing diagram: Ry2 OFF during T1, ON during T2]	OFF during T1 ON during T2																					
Indicator	OUT1 OUT2	[Timing diagram: OUT1 and OUT2 pulses]																							
Set Time		T1 T2 T1 T2																							

Operation Chart																									
Contact	Delayed SPDT + Delayed SPDT																								
Internal Connection																									
Operation Mode Selection																									
Cycle Inversion	<table border="1"> <thead> <tr> <th>Item</th> <th>Terminal No.</th> <th>Operation</th> <th>Description</th> </tr> </thead> <tbody> <tr> <td>Power</td> <td>2-7</td> <td>[Timing diagram: Power ON for duration T1 + T2]</td> <td></td> </tr> <tr> <td>Delayed Contact Ry1</td> <td>1-4 (NC) 1-3 (NO)</td> <td>[Timing diagram: Ry1 ON during T1, OFF during T2]</td> <td>ON during T1 OFF during T2</td> </tr> <tr> <td>Delayed Contact Ry2</td> <td>5-8 (NC) 6-8 (NO)</td> <td>[Timing diagram: Ry2 ON during T1, OFF during T2]</td> <td>ON during T1 OFF during T2</td> </tr> <tr> <td>Indicator</td> <td>OUT1 OUT2</td> <td>[Timing diagram: OUT1 and OUT2 pulses]</td> <td></td> </tr> <tr> <td>Set Time</td> <td></td> <td>T1 T2</td> <td></td> </tr> </tbody> </table>	Item	Terminal No.	Operation	Description	Power	2-7	[Timing diagram: Power ON for duration T1 + T2]		Delayed Contact Ry1	1-4 (NC) 1-3 (NO)	[Timing diagram: Ry1 ON during T1, OFF during T2]	ON during T1 OFF during T2	Delayed Contact Ry2	5-8 (NC) 6-8 (NO)	[Timing diagram: Ry2 ON during T1, OFF during T2]	ON during T1 OFF during T2	Indicator	OUT1 OUT2	[Timing diagram: OUT1 and OUT2 pulses]		Set Time		T1 T2	
	Item	Terminal No.	Operation	Description																					
	Power	2-7	[Timing diagram: Power ON for duration T1 + T2]																						
	Delayed Contact Ry1	1-4 (NC) 1-3 (NO)	[Timing diagram: Ry1 ON during T1, OFF during T2]	ON during T1 OFF during T2																					
	Delayed Contact Ry2	5-8 (NC) 6-8 (NO)	[Timing diagram: Ry2 ON during T1, OFF during T2]	ON during T1 OFF during T2																					
Indicator	OUT1 OUT2	[Timing diagram: OUT1 and OUT2 pulses]																							
Set Time		T1 T2																							
Interval ON	<table border="1"> <thead> <tr> <th>Item</th> <th>Terminal No.</th> <th>Operation</th> <th>Description</th> </tr> </thead> <tbody> <tr> <td>Power</td> <td>2-7</td> <td>[Timing diagram: Power ON for duration T1 + T2]</td> <td></td> </tr> <tr> <td>Delayed Contact Ry1</td> <td>1-4 (NC) 1-3 (NO)</td> <td>[Timing diagram: Ry1 ON during T1]</td> <td>ON during T1</td> </tr> <tr> <td>Delayed Contact Ry2</td> <td>5-8 (NC) 6-8 (NO)</td> <td>[Timing diagram: Ry2 ON after T1, during T2]</td> <td>ON after T1, during T2</td> </tr> <tr> <td>Indicator</td> <td>OUT1 OUT2</td> <td>[Timing diagram: OUT1 and OUT2 pulses]</td> <td></td> </tr> <tr> <td>Set Time</td> <td></td> <td>T1 T2</td> <td></td> </tr> </tbody> </table>	Item	Terminal No.	Operation	Description	Power	2-7	[Timing diagram: Power ON for duration T1 + T2]		Delayed Contact Ry1	1-4 (NC) 1-3 (NO)	[Timing diagram: Ry1 ON during T1]	ON during T1	Delayed Contact Ry2	5-8 (NC) 6-8 (NO)	[Timing diagram: Ry2 ON after T1, during T2]	ON after T1, during T2	Indicator	OUT1 OUT2	[Timing diagram: OUT1 and OUT2 pulses]		Set Time		T1 T2	
	Item	Terminal No.	Operation	Description																					
	Power	2-7	[Timing diagram: Power ON for duration T1 + T2]																						
	Delayed Contact Ry1	1-4 (NC) 1-3 (NO)	[Timing diagram: Ry1 ON during T1]	ON during T1																					
	Delayed Contact Ry2	5-8 (NC) 6-8 (NO)	[Timing diagram: Ry2 ON after T1, during T2]	ON after T1, during T2																					
Indicator	OUT1 OUT2	[Timing diagram: OUT1 and OUT2 pulses]																							
Set Time		T1 T2																							
Interval ON Delay	<table border="1"> <thead> <tr> <th>Item</th> <th>Terminal No.</th> <th>Operation</th> <th>Description</th> </tr> </thead> <tbody> <tr> <td>Power</td> <td>2-7</td> <td>[Timing diagram: Power ON for duration T1 + T2]</td> <td></td> </tr> <tr> <td>Delayed Contact Ry1</td> <td>1-4 (NC) 1-3 (NO)</td> <td>[Timing diagram: Ry1 ON during T1]</td> <td>ON during T1</td> </tr> <tr> <td>Delayed Contact Ry2</td> <td>5-8 (NC) 6-8 (NO)</td> <td>[Timing diagram: Ry2 ON after T1 + T2]</td> <td>ON after T1 + T2</td> </tr> <tr> <td>Indicator</td> <td>OUT1 OUT2</td> <td>[Timing diagram: OUT1 and OUT2 pulses]</td> <td></td> </tr> <tr> <td>Set Time</td> <td></td> <td>T1 T2</td> <td></td> </tr> </tbody> </table>	Item	Terminal No.	Operation	Description	Power	2-7	[Timing diagram: Power ON for duration T1 + T2]		Delayed Contact Ry1	1-4 (NC) 1-3 (NO)	[Timing diagram: Ry1 ON during T1]	ON during T1	Delayed Contact Ry2	5-8 (NC) 6-8 (NO)	[Timing diagram: Ry2 ON after T1 + T2]	ON after T1 + T2	Indicator	OUT1 OUT2	[Timing diagram: OUT1 and OUT2 pulses]		Set Time		T1 T2	
	Item	Terminal No.	Operation	Description																					
	Power	2-7	[Timing diagram: Power ON for duration T1 + T2]																						
	Delayed Contact Ry1	1-4 (NC) 1-3 (NO)	[Timing diagram: Ry1 ON during T1]	ON during T1																					
	Delayed Contact Ry2	5-8 (NC) 6-8 (NO)	[Timing diagram: Ry2 ON after T1 + T2]	ON after T1 + T2																					
Indicator	OUT1 OUT2	[Timing diagram: OUT1 and OUT2 pulses]																							
Set Time		T1 T2																							
Sequential Interval	<table border="1"> <thead> <tr> <th>Item</th> <th>Terminal No.</th> <th>Operation</th> <th>Description</th> </tr> </thead> <tbody> <tr> <td>Power</td> <td>2-7</td> <td>[Timing diagram: Power ON for duration T1 + T2]</td> <td></td> </tr> <tr> <td>Delayed Contact Ry1</td> <td>1-4 (NC) 1-3 (NO)</td> <td>[Timing diagram: Ry1 ON during T1 + T2]</td> <td>ON during T1 + T2</td> </tr> <tr> <td>Delayed Contact Ry2</td> <td>5-8 (NC) 6-8 (NO)</td> <td>[Timing diagram: Ry2 ON after T1, during T2]</td> <td>ON after T1, during T2</td> </tr> <tr> <td>Indicator</td> <td>OUT1 OUT2</td> <td>[Timing diagram: OUT1 and OUT2 pulses]</td> <td></td> </tr> <tr> <td>Set Time</td> <td></td> <td>T1 T2</td> <td></td> </tr> </tbody> </table>	Item	Terminal No.	Operation	Description	Power	2-7	[Timing diagram: Power ON for duration T1 + T2]		Delayed Contact Ry1	1-4 (NC) 1-3 (NO)	[Timing diagram: Ry1 ON during T1 + T2]	ON during T1 + T2	Delayed Contact Ry2	5-8 (NC) 6-8 (NO)	[Timing diagram: Ry2 ON after T1, during T2]	ON after T1, during T2	Indicator	OUT1 OUT2	[Timing diagram: OUT1 and OUT2 pulses]		Set Time		T1 T2	
	Item	Terminal No.	Operation	Description																					
	Power	2-7	[Timing diagram: Power ON for duration T1 + T2]																						
	Delayed Contact Ry1	1-4 (NC) 1-3 (NO)	[Timing diagram: Ry1 ON during T1 + T2]	ON during T1 + T2																					
	Delayed Contact Ry2	5-8 (NC) 6-8 (NO)	[Timing diagram: Ry2 ON after T1, during T2]	ON after T1, during T2																					
Indicator	OUT1 OUT2	[Timing diagram: OUT1 and OUT2 pulses]																							
Set Time		T1 T2																							

Applicable Sockets & Hold-Down Springs (Optional)

DIN Rail Mount Socket

Item		Part No.	Ordering No.	Applicable Timer	Package Quantity	Remarks
Socket	8-Pin Screw Terminal	SR2P-06A	SR2P-06A	GT3A-1/2/3, GT3F, GT3S, GT3W	1	Hold-down spring: SFA-202 (2 pcs.)
	11-Pin Screw Terminal	SR3P-05A	SR3P-05A	GT3A-4/5/6	1	Hold-down spring: SFA-203 (2 pcs.)
		SR3P-06A	SR3P-06A		1	Hold-down spring: SFA-202 (2 pcs.)
		SR3P-05C	SR3P-05C		1	Finger-safe
Hold-Down Spring		SFA-202	SFA-202PN20	—	10 sets (20 pcs)	For SR2P-06A/SR3P-06A (2 pcs/set)
		SFA-203	SFA-203PN20	—	10 sets (20 pcs)	For SR3P-05A (2 pcs/set)

Note: All are UL recognized, CSA certified, and TÜV approved.



Panel Mount Socket

Item		Part No.	Ordering No.	Applicable Timer	Package Quantity	Remarks
Socket	8-Pin Solder Terminal	SR2P-511	SR2P-511	GT3A-1/2/3, GT3F, GT3S, GT3W	1	—
	11-Pin Solder Terminal	SR3P-511	SR3P-511	GT3A-4/5/6	1	—
Hold-Down Spring		SFA-402	SFA-402PN10	—	10	For SR2P-511/SR3P-511

Note: SR2P-511 and SR3P-511 are UL recognized and CSA certified.



Panel Mount Adapter and wiring Socket Adapter

Package Quantity: 1

Item		Part No.
DIN 48mm Square Panel Mount Adapter	Color: Gray	RTB-G01
	Color: Beige	RTB-M01
	Color: Black	RTB-B01
Wiring Socket Adapter	8-Pin Solder Terminal	SR6P-S08
	8-Pin Screw Terminal	SR6P-M08G
	11-Pin Solder Terminal	SR6P-S11
	11-Pin Screw Terminal	SR6P-M11G

• Finger-safe 11-pin screw wiring socket adapter (Part No.: SR6P-C11) is also available.

(8-pin Wiring Socket Adapter)
SR6P-S08



(8-pin Screw Wiring Socket Adapter)
SR6P-M08G



(11-pin Wiring Socket Adapter)
SR6P-S11



(11-pin Screw Wiring Socket Adapter)
SR6P-M11G



Installation of Hold-Down Springs

(DIN Rail Mount Socket)

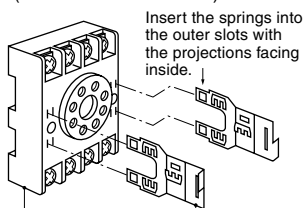

Socket SR2P-06A Hold-Down Spring (optional) SFA-202 (2 pcs/set)

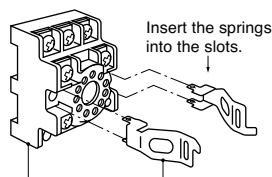

Socket SR3P-05A Hold-Down Spring (optional) SFA-203 (2 pcs/set)

(Panel Mount Socket)

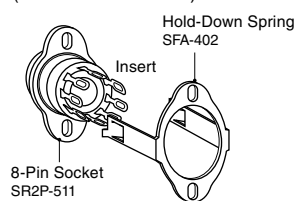

8-Pin Socket SR2P-511 SR2P-70

Note: Once installed into the socket, the hold-down springs cannot be removed.

GT3 Series Multi-function Timers

Dimensions

When Using DIN Rail Mount Socket
(SR2P-06A Socket)

GT3A-1, -2, -3/GT3F/GT3S (8-pin)

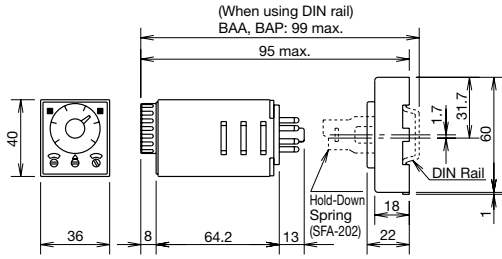

GT3W

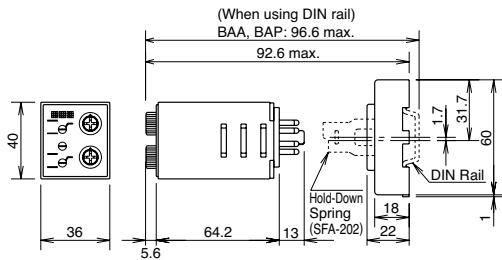

- Calculate the dimensions for mounting, referring to the diagrams of SR2P-06A on Relay Sockets catalog.

[Internal Connections]

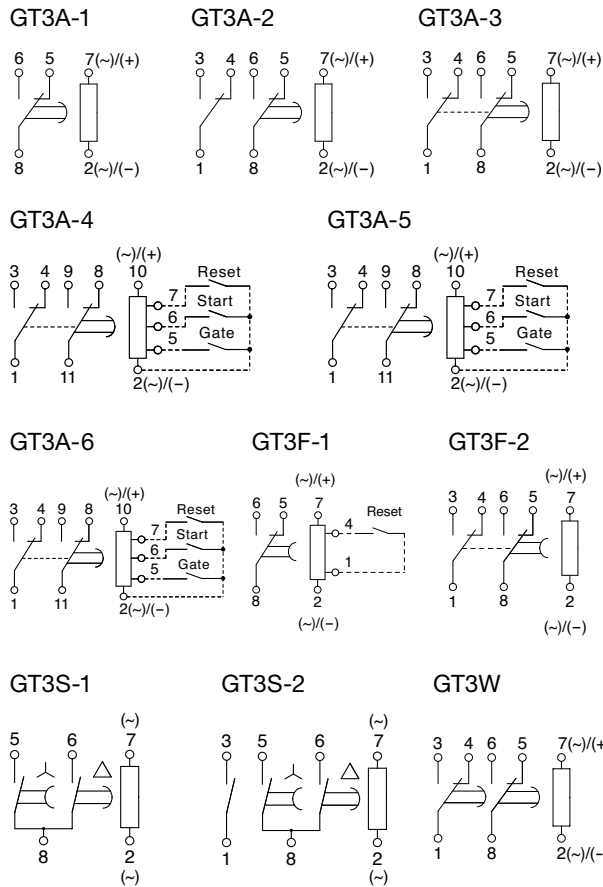

GT3A-4, -5, -6 (11-pin)
(SR3P-05A Socket)

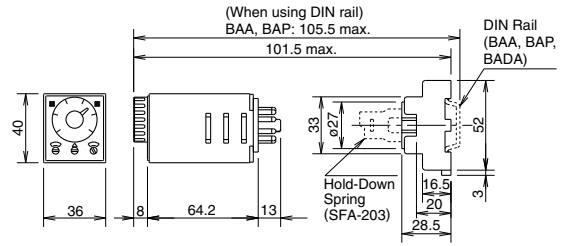

(SR3P-05C Socket)

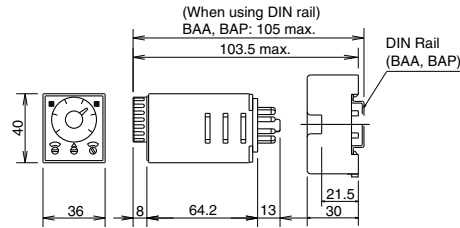

(SR3P-06A Socket)

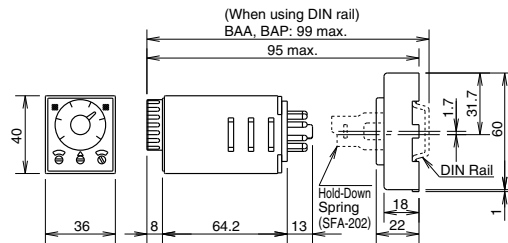

- Calculate the dimensions for mounting, referring to the diagrams in Relay Sockets catalog for SR3P-05A, SR3P-05C, and SR3P-06A.

When Using Panel Mount Socket

GT3A-1, -2, -3/GT3F/GT3S/GT3W (8-pin)
(SR2P-511 Socket)

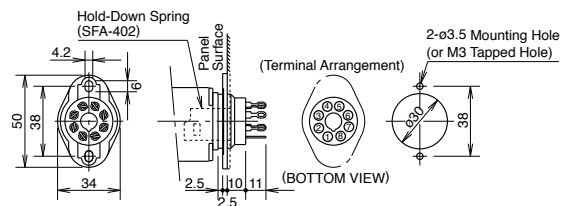

GT3A-4, -5, -6
(SR3P-511 Socket)

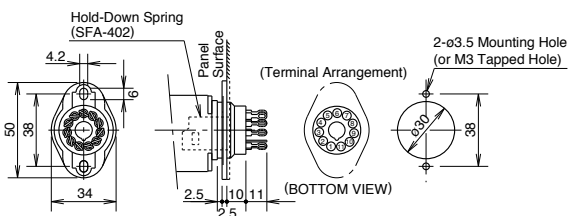

All dimensions in mm.

GT3 Series Multi-function Timers

All GT3 Series

When using DIN 48mm-square Panel Mount Adapter

(For 8-pin solder wiring socket adapter: SR6P-S08 and 11-pin solder wiring socket adapter: SR6P-S11)

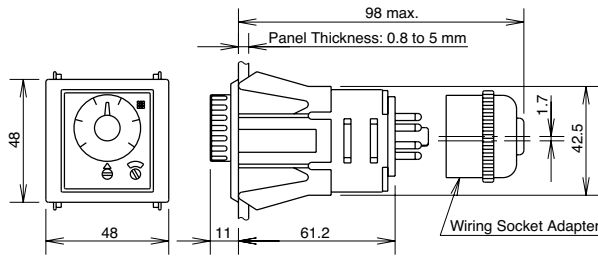

(8-pin Screw Terminal Wiring Socket Adapter: SR6P-M08G)

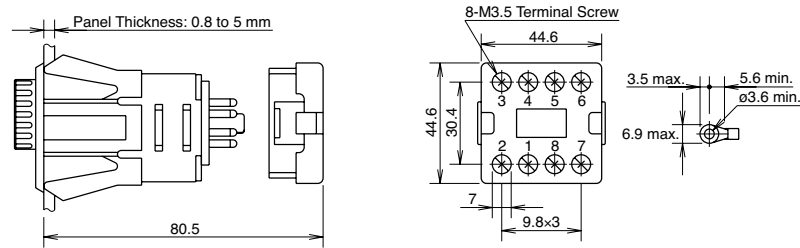

(11-pin Screw Terminal Wiring Socket Adapter: SR6P-M11G)

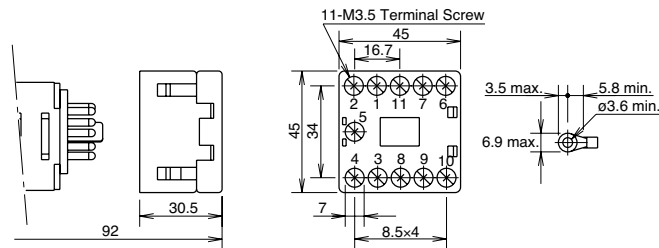

(Finger-safe 11-pin Screw Terminal Wiring Socket Adapter: SR6P-C11)

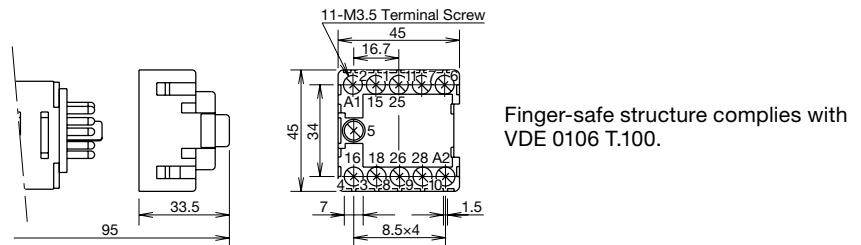

(Mounting Hole Layout)

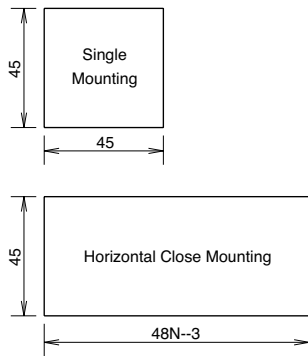

Tolerance: +0.5 to 0
N: No. of timers mounted

All dimensions in mm.

GT3 Series Instructions

Safety Precautions

- Be sure to turn off power before mounting, removal, wiring, maintenance and inspection. Otherwise, electric shock or fire may occur.
- Be sure to use wires to meet voltage and current requirements and tighten M3.5 terminal screws to a torque of 1.0 to 1.3 N·m. Be sure to solder the terminals correctly. Loose terminal screws or incomplete soldering may cause abnormal heat and fire.
- Be sure to use timers within rated specification values. Otherwise electric shock or fire may occur.

Instructions

Mode Setting

GT3A only

The operation mode can be selected from A, B, C, and D modes using the Operation Mode Selector. The operation mode is changed from A to B, C, and D in turn by turning the Operation Mode Selector clockwise using a flat screwdriver 4 mm wide maximum and the selected mode is displayed in the window. Since this selector does not turn infinitely, turn the selector clockwise when Mode A is displayed and counterclockwise when Mode D is displayed.

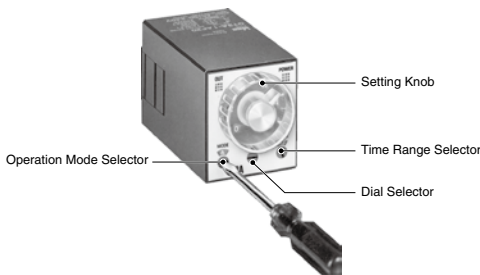

Mode Code and Operation Mode

Part No.	GT3A-1, -2, -3	GT3A-4	GT3A-5	GT3A-6
A	ON Delay	ON Delay	Interval ON	One-Shot
B	Interval ON	Cycle	One Shot Cycle	One-Shot ON Delay
C	Cycle	Signal ON/OFF Delay	Signal ON/OFF Delay	One-Shot
D	Cycle ON	Signal OFF Delay	Signal OFF Delay	Signal ON/OFF Delay

Time Range Setting

The time range is calibrated at its maximum time scale, therefore, it is desirable to use the timer at a setting as close to its maximum time scale as possible for accurate time delay. For a more accurate time delay, adjust the setting knob by measuring the operating time before application.

1. GT3A (Multi-Mode Analog Setting)

Time range can be selected from 1S, 10S, 10M, and 10H by turning the Time Range Selector with a flat screwdriver 4 mm wide maximum. The four different ranges of 0 to 1, 0 to 3, 0 to 6, and 0 to 18 are displayed in the six windows by turning the Dial Selector, allowing for selecting the best suited scale. Since the selectors do not turn infinitely, turn the selectors clockwise when 1S or 0-1 is displayed and counterclockwise when 10H or 0-18 is displayed.

Time Range Determined by Time Range Selector and Dial Selector

Time Range	Dial Selector			
	0 - 1	0 - 3	0 - 6	0 - 18
1S	0.1 sec to 1 sec	0.1 sec to 3 sec	0.1 sec to 6 sec	0.2 sec to 18 sec
10S	0.1 sec to 10 sec	0.3 sec to 30 sec	0.6 sec to 60 sec	1.8 sec to 180 sec
10M	6 sec to 10 min	18 sec to 30 min	36 sec to 60 min	108 sec to 180 min
10H	6 min to 10 hours	18 min to 30 hours	36 min to 60 hours	108 min to 180 hours

The set time is selected by turning the setting knob.

[Setting Examples]

- When the setting knob is set at 1.5, with dial 0-3 and time range 10S selected, then the set time is 15 sec (1.5 × 10S).
- When the setting knob is set at 0.2, with dial 0-1 and time range 10H selected, then the set time is 2 hours (0.2 × 10H).

2. GT3F (OFF Delay)

The time range of GT3F-1 and GT3F-2 can be selected between 1S and 10S with the Time Range Selector by using a flat screw driver. The selected time range (0-1, 0-3, 0-18, or 0-60) is displayed in the six windows of the Setting Knob by turning Dial Selector which allows to set the scale. Note that the switches do not turn infinitely.

Time Range Determined by Time Range Selector and Dial Selector

(2) Range	(1) Dial			
	0 - 1	0 - 3	0 - 18	0 - 60
1S	0.1 sec to 1 sec	0.1 sec to 3 sec	0.2 sec to 18 sec	0.6 sec to 60 sec
10S	0.1 sec to 10 sec	0.3 sec to 30 sec	1.8 sec to 180 sec	6 sec to 600 sec

The set time is selected by turning the Setting Knob.

[Setting Examples]

- When the setting knob is set at 2.5, with dial 0-3 and range 1S selected, then the set time is 2.5 sec (2.5 × 1S).
- When the setting knob is set at 15, with dial 0-18 and range 10S selected, then the set time is 150 sec (15 × 10S).

3. GT3S (Star-Delta)

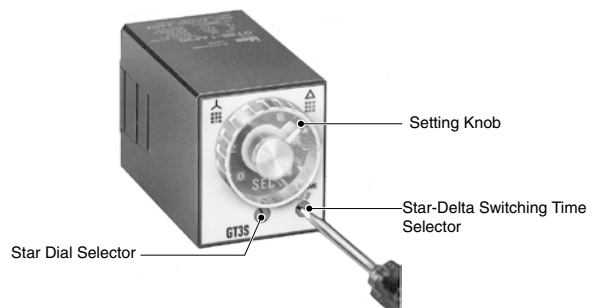

The scale range on the star side can be selected from four different ranges of 0 to 5, 0 to 10, 0 to 50, and 0 to 100 displayed in the six windows by turning the Star Dial Selector. Note that the selectors does not turn infinitely.

Time Range Determined by Time Range Selector and Dial Selector

Star Dial Selector		Star-Delta Switching Time Selector	
Dial	Time Range	Indication	Time
0 - 5	0.05 sec - 5 sec	0.05	0.05 sec
0 - 10	0.1 sec - 10 sec	0.1	0.1 sec
0 - 50	0.3 sec - 50 sec	0.25	0.25 sec
0 - 100	1 sec - 100 sec	0.5	0.5 sec

The Star ON time is selected by turning the Setting Knob.

[Setting Examples]

- If the setting knob is set at 8, with Star Dial Selector 0-10 and Star-Delta switching time 0.1S selected, the Star ON time (T_1) is 8 sec and the Star-Delta switching time (T_2) is 0.1 sec.

4. GT3W [Twin-Timer]

Use a flat screwdriver with a diameter of 4 mm maximum to turn Time Range Selector and gain time range as shown in the table below. Note that the selectors do not turn infinitely.

Time Range Determined by Time Range Selector and Dial Selector

0.1 sec to 6 hours			0.1 sec to 300 hours		
Time Range Selector	Scale	Time Range	Time Range Selector	Scale	Time Range
1S	0 - 1	0.1 sec to 1 sec	1S	0 - 3	0.1 sec to 3 sec
10S		0.3 sec to 10 sec	1M		3.8 sec to 3 min
10M		15 sec to 10 min	1H		3.8 min to 3 hours
1S	0 - 6	0.1 sec to 6 sec	1S	0 - 30	0.6 sec to 30 sec
10S		1.3 sec to 60 sec	1M		38 sec to 30 min
1M		7.5 sec to 1 min	1H		38 min to 30 hours
10M		75 sec to 60 min	10H		6.3 hours to 300 hours
1H		7.5 min to 6 hours			

Note: No blank time range can be set.



Selector Setting

- Use a flat screwdriver with a diameter of 4 mm maximum to turn the selector. Turn the selector until it clicks. Otherwise, malfunction may occur. Also, do not rotate the selector forcibly since the selector does not turn infinitely.
- Since changing the setting during operation may cause malfunction, turn power off before changing the setting.

Power

- Since DC types have a polarity in their power supply connection, connect the power according to wiring diagram.
- Since AC type GT3A, GT3S, and GT3W comprise a capacitive load, the SSR dielectric strength should be two or more times as large as the power voltage when switching the timer power using an SSR.

Wiring

The GT3F, consisting of a high-impedance circuit, may not be reset due to the influence of an inductive voltage or residual voltage caused by a leakage current. In not reset, connect an RC filter or bleeder resistor between power terminals so that the voltage between power terminals can be reduced to less than 15% of the rated voltage.

Inputs of GT3A and GT3F

To avoid electric shock, do not touch the input signal terminal during power voltage application.

- When connecting the input signal terminals of two or more GT3A timers to the same contact or transistor, the input terminals of the same number should be connected. (Connect Terminals No. 2 in common.)
- Never apply the input signals to two or more GT3F timers using the same contact or transistor.

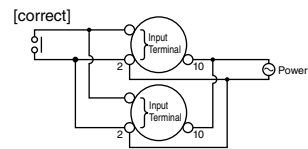
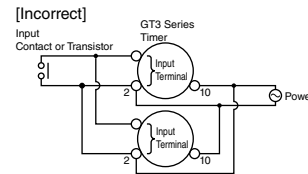

- In a transistor circuit for controlling input signals with its primary and secondary power circuits isolated, do not ground the secondary circuit.

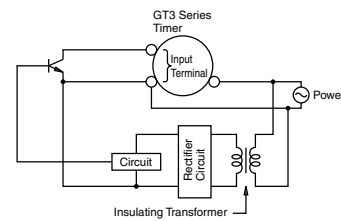

- Do not connect input signal terminals of the GT3A timer to other terminals than No. 2. Never apply voltage to input signal terminals. Otherwise, the internal circuit may be damaged.

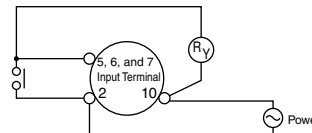

- Do not connect input signal terminals of the GT3F timer to other terminals than No. 2. Never apply voltage to input signal terminals. Otherwise, the internal circuit may be damaged.
- Input signal lines must be made as short as possible and installed away from power cables and power lines. Shielded wires or a separate conduit should be used for input wiring.
- For contact input, use reliable gold-plated contacts to make sure that the residual voltage is less than 1V when the contacts are closed.

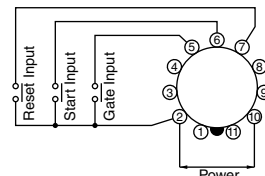

- For transistor input, use transistors with following specifications; $V_{CE} = 40V$, $V_{CES} = 1V$ or less, $I_C = 50mA$ or more, $I_{CBO} = 50\mu A$ or less. The resistance should be less than $1k\Omega$ when the transistor is on. When the output transistor switches on, a signal is inputted to the timer.

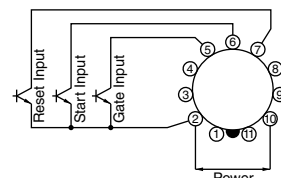

GT3 Series Instructions

GT3A

Transistor output equipment such as proximity switches and photoelectric switches can input signals if they are voltage/current output type, power voltage ranges from 18 to 30V, and residual voltage is 1V. When the signal voltage switches from H to L, a signal is inputted to the timer.

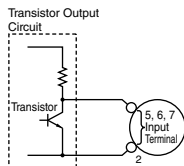

GT3F

Do not input signals using transistor output equipment of a voltage/current output type. Otherwise, the internal circuit may be damaged.

Minimum Power Application Time

If the power application time to the GT3F is shorter than the minimum power application time, the output relay may not operate or the timer may operate faster than the preset time.

Time Range Setting

Repeat error is calibrated at its maximum time scale, therefore, it is desirable to use the timer at a setting as close to its maximum time scale as possible for accurate time delay. For a more accurate time delay, adjust the setting knob by measuring the operating time before application.

Time Accuracy

Repeat Error

This indicates variance of operation time when operation is repeated under the same conditions. The variance is calculated from the following formula and the measurements should be done 5 times at least.

$$= \pm \frac{1}{2} \times \frac{\text{Max. measured value} - \text{Min. measured value}}{\text{Maximum scale value}} \times 100 (\%)$$

Voltage Error

This indicates the variance of operation time when the voltage at operation current varies within allowable voltage variance.

$$= \pm \frac{T_v - T_r}{T_r} \times 100 (\%)$$

T_v : Average of measured operation time values at voltage V

T_r : Average of measured operation time values at the rated voltage

Temperature Error

This indicates the influence caused by the change in temperature during operation within operating temperature. This is shown with the variance of operation time.

$$= \pm \frac{T_t - T_{20}}{T_{20}} \times 100 (\%)$$

T_t : Average of operation times at temperature t

T_{20} : Average of operation times at reference temperature (20°C)

Setting Error

This indicates the deviation, range, and gap between actual operation time and that on scale.

$$= \pm \frac{\text{Average of measured values} - \text{Set value}}{\text{Maximum scale value}} \times 100 (\%)$$

Ex.)

GT3 setting error: $\pm 10\%$

When the maximum scale value is 10 sec. and setting time is 1 to 3 sec., the setting error is ± 1 sec. and operating time is 1 to 3 sec. When setting a value near the lower limit, be sure to confirm the actual operating time.

Load Current

The rated current of the contact (or control output) should not be exceeded. Especially for inductive, capacitive, and incandescent lamp loads, the inrush current as large as a few to several tens times the rated current may cause welded contacts and other troubles. The amount of inrush current as well as steady-state current must be taken into consideration.

Contact Protection

Switching an inductive load generates a counter-electromotive force in the coil. The counter emf will cause arcing, which may shorten the contact life. Application of a protection circuit is recommended for contact protection.

Rest Time

When turning power off after time-out or during operation, allow a rest time longer than the reset time to restart. (Each model has a different reset time.)

Continuous Energizing

Continuous energizing for a long period of time may damage the electrical characteristics of the timer because of internal heating. Use an additional relay to the output circuit and refrain from continuous energizing of the timer.

Dielectric Strength Test

When performing an insulation resistance or dielectric-strength test on control panels containing timers, make sure that the dielectric strength of the timer is not exceeded. In case the dielectric strength is exceeded, remove the timers from the panels.

Operating Environment

Temperature and Humidity

Use the timer within the operating temperature and operating humidity ranges and prevent freezing and condensation. After storing below the operation temperature, leave the timer at room temperature for a sufficient period of time before use.

Environment

Prevent a corrosive gas such as sulfurous or ammonia gas, organic solvents (alcohol, benzene, thinner, etc.), strong alkaline substances or strong acids from touching to the timer, and do not use the timer in such an environment. Keep the timer from water splashes or steam.

Vibration and Shock

Since excessive vibrations or shocks cause the output contacts to open, the timer should be used within the operating extremes of vibration and shock resistance. Use of hold-down springs is recommended for secure mounting on sockets.

Noise and Static Charge

Check the operation of the timer before using in an environment with a lot of noise. Install the input signal source, input signal wiring and timer away from noise source and high-voltage wire with noise as much as possible. Also, in case of using the timer under the environment with multiple static charge (pipe transportation of molding material, power/liquid material, etc.), place the timer away from such static charge source as well.



Others

- The GT3F does not read the preset values of each selector after power is turned off. Note that minimizing the preset time does not shorten the delay time after power is turned off.
- To make a sequence circuit by connecting timers and relays, check the timer operation sufficiently in consideration of the reset time of the timer.
- Storage temperature should range from -30°C to $+70^{\circ}\text{C}$. If the product has been stored at a temperature below -10°C , leave the product at room temperatures for more than 3 hours before using.
- Do not remove the housing.
- In the GT3 timers, latching relay is used for output relay. Shocks such as dropping during transportation or handling may cause the output to be different from the initial value. Be sure to check the output status using a tester.

GT5Y Miniature Electronic Timers

Four Selectable Time Ranges Delayed Output 4PDT/3A or DPDT/5A

- Three operation modes: ON Delay, Interval ON, and Cycle
- Repeat error: $\pm 0.2\% \pm 20$ ms maximum
- Miniature size
- LED indicators for output and power
- Complies with safety standards.
UL/c-UL listed. EN compliant.

Applicable Standards	Mark	File No. or Organization
UL508 CSA C22.2 No.14		UL/c-UL Listed File No. E55996
EN61812-1		EU Low Voltage Directive



Package Quantity: 1

Operation Mode	Contact	Output	Time Ranges (4 ranges selectable)	Operating Voltage	Part No.	
ON Delay	DPDT	220V AC/ 30V DC, 5A	1S/10S/1M/10M	100 to 120V AC	GT5Y-2SN1A100	
			3S/30S/3M/30M		GT5Y-2SN3A100	
			6S/60S/6M/60M		GT5Y-2SN6A100	
			1S/10S/1M/10M		200 to 240V AC	GT5Y-2SN1A200
			3S/30S/3M/30M			GT5Y-2SN3A200
			6S/60S/6M/60M			GT5Y-2SN6A200
		12V DC	1S/10S/1M/10M	GT5Y-2SN1D12		
			3S/30S/3M/30M	GT5Y-2SN3D12		
			6S/60S/6M/60M	GT5Y-2SN6D12		
			24V DC	1S/10S/1M/10M	GT5Y-2SN1D24	
				3S/30S/3M/30M	GT5Y-2SN3D24	
				6S/60S/6M/60M	GT5Y-2SN6D24	
	4PDT	220V AC/ 30V DC, 3A	1S/10S/1M/10M	100 to 120V AC	GT5Y-4SN1A100	
			3S/30S/3M/30M		GT5Y-4SN3A100	
			6S/60S/6M/60M		GT5Y-4SN6A100	
			1S/10S/1M/10M		200 to 240V AC	GT5Y-4SN1A200
			3S/30S/3M/30M			GT5Y-4SN3A200
			6S/60S/6M/60M			GT5Y-4SN6A200
		12V DC	1S/10S/1M/10M	GT5Y-4SN1D12		
			3S/30S/3M/30M	GT5Y-4SN3D12		
			24V DC	1S/10S/1M/10M	GT5Y-4SN1D24	
				3S/30S/3M/30M	GT5Y-4SN3D24	
				6S/60S/6M/60M	GT5Y-4SN6D24	
			Interval ON	DPDT	220V AC/ 30V DC, 5A	100 to 120V AC
12V DC	GT5Y-2SV1D12					
24V DC	GT5Y-2SV1D24					
4PDT	220V AC/ 30V DC, 3A	100 to 120V AC		GT5Y-4SV1A100		
		24V DC		GT5Y-4SV1D24		
		Cycle		DPDT	220V AC/ 30V DC, 5A	100 to 120V AC
200 to 240V AC	GT5Y-4SF1A200					
4PDT	220V AC/ 30V DC, 3A	200 to 240V AC	GT5Y-4SF1A200			
		24V DC	GT5Y-4SF1D24			

Note: S and M of the time range indicate second, and minute respectively.

Accessories

Both SY4S-05C and SM2S-05C are UL recognized, CSA certified, and TÜV approved. Others are UL recognized and CSA certified, except for SY4S-05A and SM2S-05A. When ordering, specify the Ordering No.

Item	Part No.	Ordering No.	Package Quantity	Remarks	
DIN Rail Mount Socket	Socket	SY4S-05A	SY4S-05A	1	For 4PDT contact
		SY4S-05C	SY4S-05C	1	For 4PDT contact
		SY4S-05D	SY4S-05D	1	For 4PDT contact
		SY4S-05DF	SY4S-05DF	1	For 4PDT contact
		SU2S-11L	SU2S-11L	1	For DPDT contact
		SU4S-11L	SU4S-11L	1	For 4PDT contact
		SM2S-05A	SM2S-05A	1	For DPDT contact
		SM2S-05C	SM2S-05C	1	For DPDT contact
		SM2S-05D	SM2S-05D	1	For DPDT contact
		SM2S-05DF	SM2S-05DF	1	For DPDT contact
Hold-Down Spring	SFA-202	SFA-202PN20	10 sets (20 pcs)	For SY4S-05A, SM2S-05A (2 pcs/set)	
		SFA-511	SFA-511PN20	20	For SY4S-05D, SY4S-05DF, SM2S-05D, SM2S-05DF
Panel/PC Board Mount Socket	Socket	SY4S-51	SY4S-51	1	For 4PDT contact, Solder Terminal
		SY4S-61	SY4S-61	1	For 4PDT contact, PC Board Terminal
		SM2S-51	SM2S-51	1	For DPDT contact, Solder Terminal
		SM2S-61	SM2S-61	1	For DPDT contact, PC Board Terminal
	Hold-Down Spring	SFA-302	SFA-302PN20	10 sets (20 pcs)	For SY4S-51, SY4S-61, SM2S-51, SM2S-61 (2 pcs/set)

Time Ranges

Code	Scale	Time Range Indication	Time Range
1S	0 to 10	$\times 0.1$ S	0.1 sec to 1 sec
10S	0 to 10	$\times 1$ S	0.2 sec to 10 sec
1M	0 to 10	$\times 0.1$ M	1.2 sec to 1 min
10M	0 to 10	$\times 1$ M	12 sec to 10 min
3S	0 to 3	$\times 1$ S	0.1 sec to 3 sec
30S	0 to 3	$\times 10$ S	0.5 sec to 30 sec
3M	0 to 3	$\times 1$ M	3 sec to 3 min
30M	0 to 3	$\times 10$ M	30 sec to 30 min
6S	0 to 6	$\times 1$ S	0.1 sec to 6 sec
60S	0 to 6	$\times 10$ S	1 sec to 60 sec
6M	0 to 6	$\times 1$ M	6 sec to 6 min
60M	0 to 6	$\times 10$ M	1 min to 60 min

Contact Ratings

Part No.	GT5Y-4	GT5Y-2
Contact Configuration	4PDT	DPDT
Rated Load	Resistive Load	220V AC, 3A 30V DC, 3A
	Inductive Load $\cos\phi=0.3$ L/R=7ms	220V AC, 0.8A 30V DC, 1.5A
Maximum Switching Voltage	250V AC/125V DC	250V AC/125V DC
Maximum Switching Current	3A	5A (Note)
Maximum Switching Frequency	1800 operations/hour	1800 operations/hour
Allowable Contact Power	Resistive Load	AC: 660VA DC: 90W
	Inductive Load $\cos\phi=0.3$ L/R=7ms	AC: 176VA DC: 45W
Minimum Applicable Load	5V DC, 10mA (reference value) 24V DC, 5mA (reference value)	5V DC, 20mA (reference value) 24V DC, 10mA (reference value)
External Protection Element	Fuse 250V 3A	Fuse 250V 5A
Life	Electrical	200,000 operations minimum (220V AC, 3A)
	Mechanical	50 million operations minimum

Note: See Operating Temperature - Maximum Switching Current Characteristics.

Operating Temperature - Maximum Switching Current Characteristics

Check the derating curve described below when mounting more than two GT5Y-2 timers and SM2S-05* sockets.

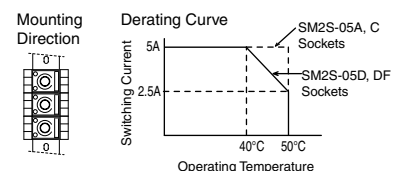

GT5Y Miniature Electronic Timers

General Specifications

Model	GT5Y-□SN	GT5Y-□SV	GT5Y-□SF
Operation	ON Delay	Interval	Cycle
Pollution Degree	2 (IEC60664-1)		
Overvoltage Category	III (IEC60664-1)		
Rated Operational Voltage	A200	200 to 240V AC (50/60Hz)	
	A100	100 to 120V AC (50/60Hz)	
	D24	24V DC	
	D12	12V DC	
Voltage Range	A200	170 to 264V AC (50/60Hz)	
	A100	85 to 132V AC (50/60Hz)	
	D24	21.6 to 26.4V DC	
	D12	10.8 to 13.2V DC	
Reset Voltage	Rated Voltage × 20% minimum		
Operating Temperature	-10 to +50°C (no freezing and condensation)		
Storage/Transportation Temperature	-30 to +80°C (no freezing and condensation)		
Operating Humidity	35 to 85% RH (no condensation)		
Storage Humidity	35 to 85% RH (no condensation)		
Altitude	0 to 2000m (operation)		
	0 to 3000m (transportation)		
Reset Time	100 ms maximum		
Repeat Error	±0.2%, ±20 ms		
Voltage Error	±0.5%, ±20 ms		
Temperature Error	±3%		
Setting Error	±10%		
Insulation Resistance	100 MΩ minimum (500V DC megger)		
Dielectric Strength	Between power and output terminals: 2000V AC, 1 minute		
	Between contacts of different poles: 2000V AC, 1 minute		
	Between contacts of the same pole: 1000V AC, 1 minute		
Vibration Resistance	10 to 55 Hz, amplitude 0.75 mm, 2 hours each in 3 directions		
Shock Resistance	Operating extremes: 98 m/s ² , Damage limits: 490 m/s ² , 3 shocks each in 6 directions		
Degree of Protection	IP40 (timer), IP20 (socket) (IEC60529)		
Power Consumption (approx.)	A200	1.6 VA (200V AC/60Hz)	
	A100	1.4 VA (100V AC/60Hz)	
	D24	1.0W	
	D12	0.9W	
Dimensions	27.5H × 21.0W × 58.6D mm		
Weight (approx.)	50g		

Note: See Operating Temperature – Maximum Switching Current Characteristics.

Electrical Life Curves

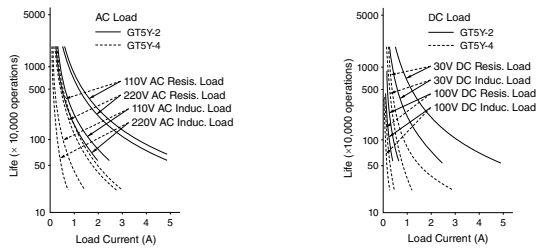

Dimensions

(When using DIN Rail Mount Socket)

GT5Y-4

See Relay Sockets catalog for SY4S-05A, SY4S-05C, SY4S-05D, SY4S-05DF.

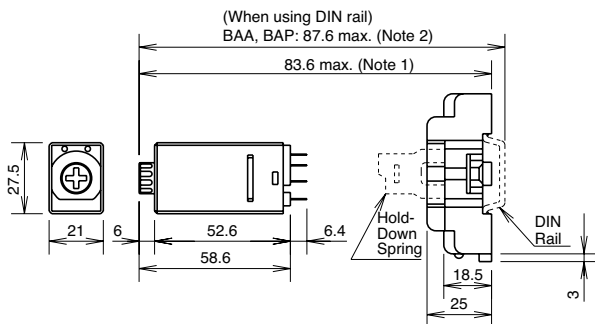

Note 1: SY4S-05A: 83.6 max., SY4S-05C: 83.6 max., SY4S-05D: 88.6 max., SY4S-05DF: 88.6 max.

Note 2: SY4S-05A: 87.8 max., SY4S-05C: 87.8 max., SY4S-05D: 92.8 max., SY4S-05DF: 92.8 max.

Operation Charts and Internal Connections

Operation Mode	Item	Operation
ON Delay	Terminal No. 13-14 (POWER)	Set Time
	1-9, 3-11, 2-10, 4-12 (NC)	
	5-9, 7-11, 6-10, 8-12 (NO)	
	POWER Indicator	
	OUT Indicator	
Interval ON	Terminal No. 13-14 (POWER)	Set Time
	1-9, 3-11, 2-10, 4-12 (NC)	
	5-9, 7-11, 6-10, 8-12 (NO)	
	POWER Indicator	
	OUT Indicator	
Cycle	Terminal No. 13-14 (POWER)	Set Time
	1-9, 3-11, 2-10, 4-12 (NC)	
	5-9, 7-11, 6-10, 8-12 (NO)	
	POWER Indicator	
	OUT Indicator	

(Internal Connections)

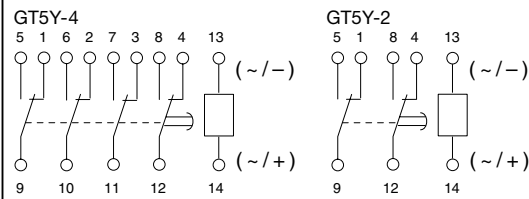

GT5Y-2

See Relay Sockets catalog for SM2S-05A, SM2S-05C, SM2S-05D, SM2S-05DF.

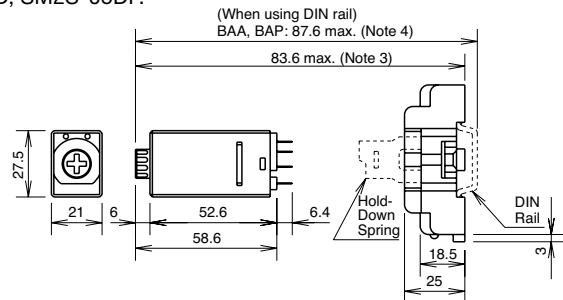

Note 3: SM2S-05A: 83.6 max., SM2S-05C: 83.6 max., SM2S-05D: 88.6 max., SM2S-05DF: 88.6 max.

Note 4: SM2S-05A: 87.8 max., SM2S-05C: 87.8 max., SM2S-05DN: 92.8 max., SY4S-05DF: 92.8 max.

GT5Y-4 and SU4S-11L, GT5Y-2 and SU2S-11L

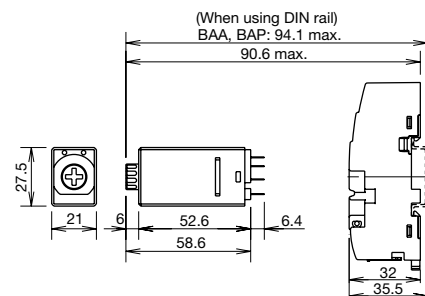



Applicable hold-down spring: SFA-202

GT5P Miniature Electronic Timers

Economic Efficiency Focused Delayed Output SPDT/5A

- Three operation modes: ON Delay, Cycle, and One Shot
- Repeat error: $\pm 0.2\%$ ± 10 ms maximum
- Complies with safety standards
UL recognized, CSA certified, TÜV approved, EN compliant

Applicable Standards	Mark	File No. or Organization
UL508		UL/c-UL recognized File No. E55996
CSA C22.2 No.14		CSA File No. LR66809
EN61812-1		EU Low Voltage Directive



Package Quantity: 1

Operation Mode	Contact	Output	Time Range	Operating Voltage	Part No. (Ordering No.)			
ON Delay	SPDT	24V DC/ 120V AC, 5A 240V AC, 3A	3S	100 to 120V AC	GT5P-N3SA100			
			10S		GT5P-N10SA100			
			30S		GT5P-N30SA100			
			60S		GT5P-N60SA100			
			3M		GT5P-N3MA100			
			6M		GT5P-N6MA100			
			10M		GT5P-N10MA100			
			1S		200 to 240V AC	GT5P-N1SA200		
			6S	GT5P-N6SA200				
			10S	GT5P-N10SA200				
			30S	GT5P-N30SA200				
			60S	GT5P-N60SA200				
			3M	GT5P-N3MA200				
			6M	GT5P-N6MA200				
			10M	GT5P-N10MA200				
			1S	24V AC/DC	GT5P-N1SAD24			
			6S		GT5P-N6SAD24			
			10S		GT5P-N10SAD24			
			60S		GT5P-N60SAD24			
			6M		GT5P-N6MAD24			
			10M		GT5P-N10MAD24			
			10S		12V DC	GT5P-N10SD12		
			30S			GT5P-N30SD12		
			60S	GT5P-N60SD12				
10M	GT5P-N10MD12							
Cycle	SPDT	24V DC/ 120V AC, 5A 240V AC, 3A	3S	100 to 120V AC	GT5P-F3SA100			
			10S		GT5P-F10SA100			
			3S	200 to 240V AC	GT5P-F3SA200			
			10S		GT5P-F10SA200			
			3S	24V AC/DC	GT5P-F3SAD24			
			10S		GT5P-F10SAD24			
			3S	12V DC	GT5P-F3SD12			
			10S		GT5P-F10SD12			
			One Shot	SPDT	24V DC/ 120V AC, 5A 240V AC, 3A	3S	100 to 120V AC	GT5P-P3SA100
						10S		GT5P-P10SA100
3S	200 to 240V AC	GT5P-P3SA200						
10S		GT5P-P10SA200						
3S	24V AC/DC	GT5P-P3SAD24						
10S		GT5P-P10SAD24						

Note: S and M of time range indicate second and minute respectively.

Accessories

Item	Part No.	Ordering No.	Package Quantity	Remarks	
DIN Rail Mount Socket	Socket	SR2P-06A	SR2P-06A	1	
		SR2P-05A	SR2P-05A	1	
		SR2P-05C	SR2P-05C	1	UL/CSA/TÜV
	Hold-Down Spring	SFA-202	SFA-202PN20	10 sets (20 pcs)	For SR2P-06A (2 pcs/set)
SFA-203		SFA-203PN20	10 sets (20 pcs)	For SR2P-05A (2 pcs/set)	
Panel Mount Socket	w/Solder Terminals	SR2P-511	SR2P-511	1	UL/CSA
	w/Wire Wrap Terminals	SR2P-70	SR2P-70	1	

Time Ranges

Code	Time Range
1S	0.1 sec to 1 sec
3S	0.1 sec to 3 sec
6S	0.1 sec to 6 sec
10S	0.2 sec to 10 sec
30S	0.5 sec to 30 sec
60S	1 sec to 60 sec
3M	3 sec to 3 min
6M	6 sec to 6 min
10M	10 sec to 10 min

Contact Ratings

Contact Configuration	SPDT	
Maximum Switching Voltage	250V AC, 150V DC	
Maximum Switching Current	5A	
Maximum Switching Power	AC: 960VA DC: 120W	
Rated Load	Resistive Load	120V AC / 24V DC, 5A 240V AC, 3A
	Inductive Load $\cos\phi = 0.3 - 0.4$ L/R = 15 ms	240V AC, 0.8A 120V AC, 1.4A 24V DC, 1.7A
Life	Electrical	100,000 operations minimum (rated resistive load)
	Mechanical	20,000,000 operations minimum

Minimum Applicable Load: 5V DC 10 mA (reference value)

GT5P Miniature Electronic Timers

General Specifications

Model	GT5P-N	GT5P-F	GT5P-P
Operation	ON Delay	Cycle	One Shot
Pollution Degree	2 (IEC60664-1)		
Rated Operational Voltage	A200	200 to 240V AC (50/60Hz)	
	A100	100 to 120V AC (50/60Hz)	
	AD24	24V AC (50Hz/60Hz)/24V DC	
	D12	12V DC	
Voltage Range	A200	170 to 264V AC (50/60Hz)	
	A100	85 to 132V AC (50/60Hz)	
	AD24	20.4 to 26.4V AC (50/60Hz)/21.6 to 26.4V DC	
	D12	10.8 to 13.2V DC	
Operating Temperature	-10 to +50°C (no freezing)		
Storage Temperature	-30 to +70°C (no freezing)		
Operating Humidity	35 to 85% RH (no condensation)		
Storage Humidity	30 to 85% RH (no condensation)		
Altitude	0 to 2000m (operation) 0 to 3000m (transportation)		
Reset Time	100 ms maximum		
Repeat Error	±0.2%, ±10 ms		
Voltage Error	±0.5%, ±20 ms		
Temperature Error	±3%		
Setting Error	±10%		
Insulation Resistance	100 MΩ minimum (500V DC megger)		
Dielectric Strength	Between power and output terminals: 2000V AC, 1 minute		
	Between contacts of different poles: 2000V AC, 1 minute		
	Between contacts of the same pole: 750V AC, 1 minute		
Vibration Resistance	10 to 55Hz, amplitude 0.75 mm, 2 hours each in 3 directions		
Shock Resistance	Operating extremes: 98 m/s ² , Damage limits: 490 m/s ²		
Power Consumption (approx.)	A200	3.9 VA (60Hz)	5.6 VA (60Hz)
	A100	2.3 VA (60Hz)	2.9 VA (60Hz)
	AD24	1.3 VA (60Hz)/0.5W	1.2 VA (60Hz)/0.5W
	D12	0.6W	0.6W
Dimensions	36H × 29W × 81.5D mm		
Weight (approx.)	49g		

Operation Charts and Internal Connections

Operation Mode	Item	Operation
On Delay	Terminal No. 2-7 (POWER)	
	5-8 (NC)	
	6-8 (NO)	
	POWER Indicator	
	OUT Indicator	
Cycle	Terminal No. 2-7 (POWER)	
	5-8 (NC)	
	6-8 (NO)	
	POWER Indicator	
	OUT Indicator	
One Shot	Terminal No. 13-14 (POWER)	
	3-4 (Start Input)	
	5-8 (NC)	
	6-8 (NO)	
	OUT Indicator	

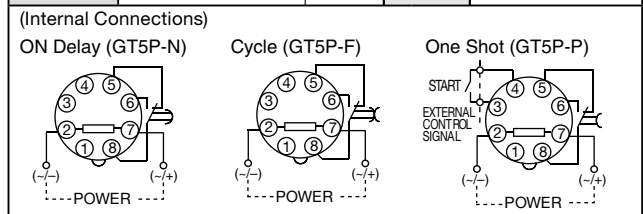

Electrical Life Curves

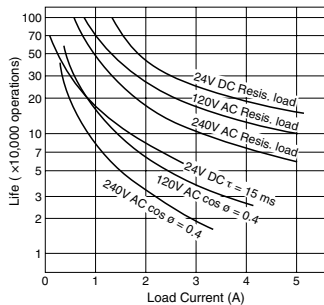

Dimensions

(When using DIN Rail Mount Socket)

SR2P-05A

For SR2P-05C, see Relay Sockets catalog.

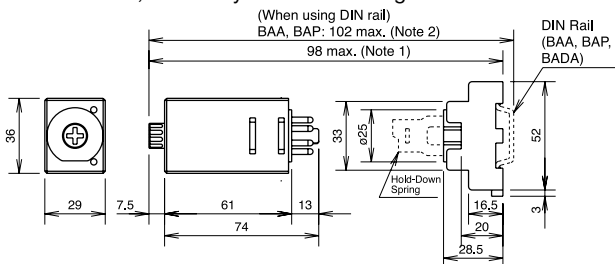

Note 1: SR2P-05C: 99.5 max.
Note 2: SR2P-05C: 103.5 max.

SR2P-06B

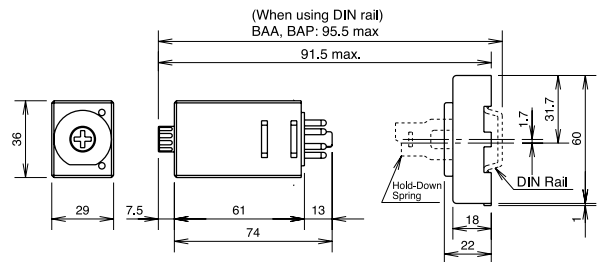

GT5Y/GT5P Miniature Electronic Timers

Dimensions / Mounting Hole Layout (for Panel/PC Board Mount Socket)

1. GT5Y-4

Panel Mount Socket (SY4S-51)

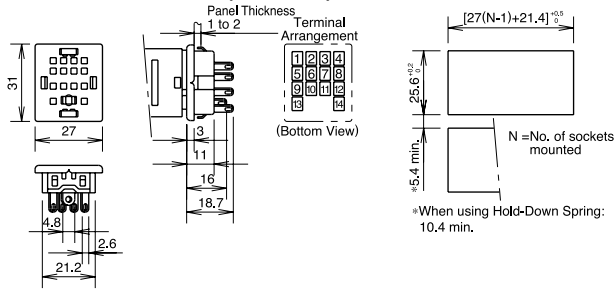

2. GT5Y-2

Panel Mount Socket (SM2S-51)

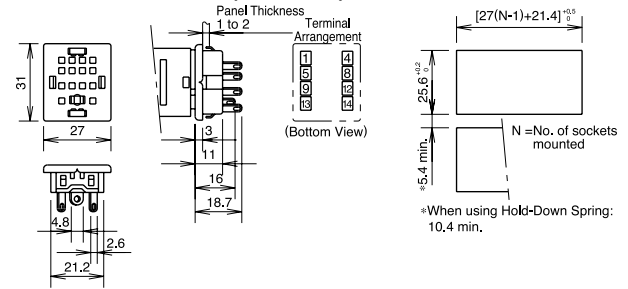

PC Board Mount Socket (SY4S-61)

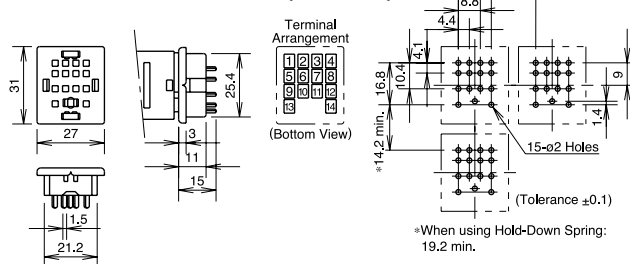

PC Board Mount Socket (SM2S-61)

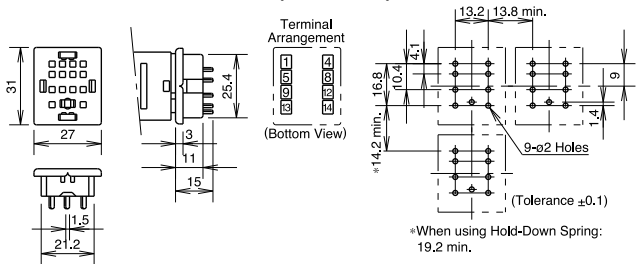

3. GT5P

Solder Terminal (SR2P-511)

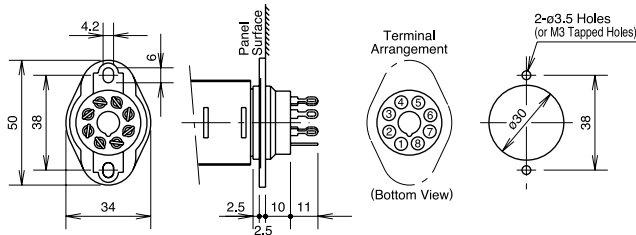

Wire Wrap Terminal (SR2P-70)

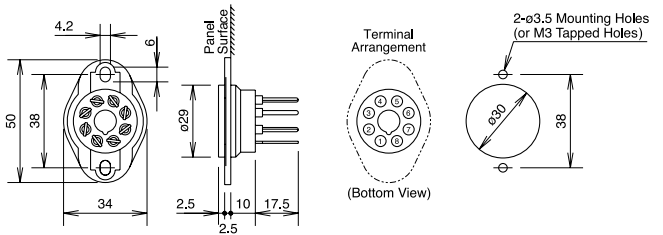

Installation of Hold-Down Springs

DIN Rail Mount Socket

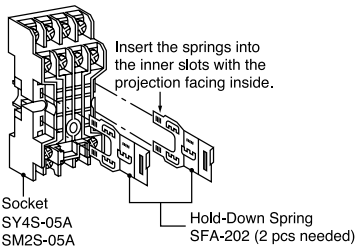

Panel/PC Board Mount Socket

The SFA-302 Hold-Down Springs can be installed to the SY4S-51, SY4S-61, SM2S-51, and SM2S-61 sockets.

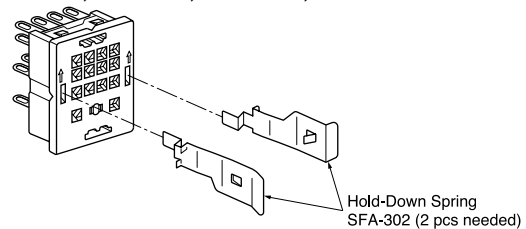

Recommended Tightening Torque and Terminal Screw

Timer	Applicable Socket	Terminal Screw	Recommended Tightening Torque
GT5Y	SY4S-05 SM2S-05	M3	0.6 to 1.0 N·m

Hold-down springs cannot be installed to SR2P-511 and SR2P-70 panel mount sockets.

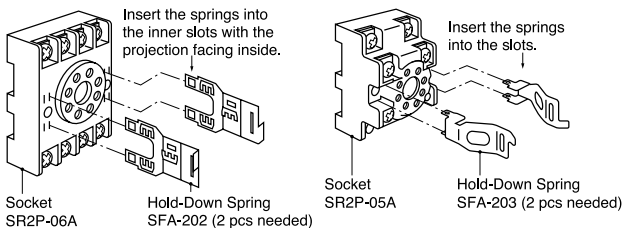

Note: Once installed into sockets, the hold-down springs cannot be removed.

Recommended Tightening Torque and Terminal Screw

Timer	Applicable Socket	Terminal Screw	Recommended Tightening Torque
GT5P	SR2P-05 SR2P-06	M3	1.0 to 1.3 N·m

GT5Y/GT5P Miniature Electronic Timers

Installation/Removal of Hold-Down Springs

(Installation)

Insert the hold-down springs (SFA-511) into mounting holes 1 and 2 with the projection facing outside.

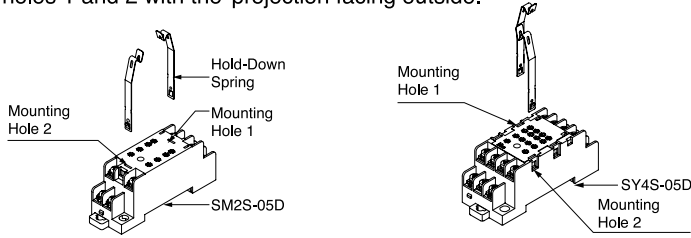

(Removal)

Press the projections of Hold-Down Springs (SFA-511) in the direction shown in the arrow and pull upward to remove.

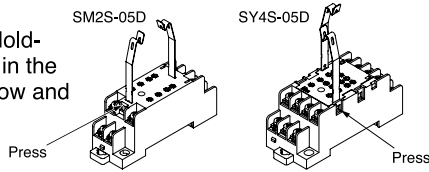

Installation/Removal of Hold-Down Springs

(Installation)

Insert the springs (SFA-511) into mounting holes 1 and 2 with the projection facing outside.

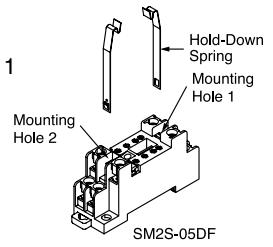

(Removal)

Press the projections of Hold-Down Springs (SFA-511) in the direction shown in the arrow and pull upward to remove.

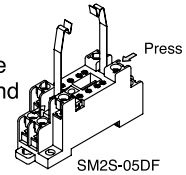

Note: Apply the same method to SY4S-05DF.



Safety Precautions

- Be sure to turn off power before mounting, removal, wiring, maintenance and inspection. Otherwise, electric shock or fire could occur.
- Be sure to use timers within rated specification values. Otherwise, electric shock or fire may occur.
- Be sure to use wires to meet voltage and current requirements and tighten M3.5 terminal screws to a tightening torque of 1.0 to 1.3 N·m. Be sure to solder the terminals correctly. Loose terminal screws or incomplete soldering may cause abnormal heat and fire.

Instructions

Time Range Setting

The time range is calibrated at its maximum time scale, therefore it is desirable to use the timer at a setting as close to its maximum time scale as possible for accurate time delay. For a more accurate time delay, adjust the control knob by measuring the operating time with a watch before application.

On the GT5Y timers, a desired time range can be selected using the time range selectors on the side surface. Turn the multiplier and time unit selectors using a flat screwdriver until they click.

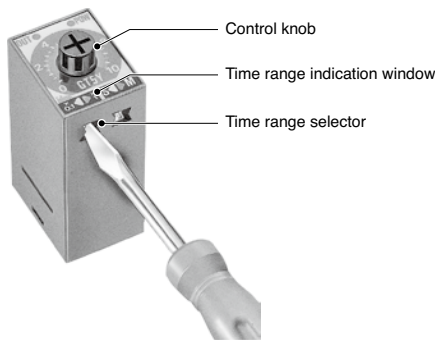

Timing Accuracy

Timing accuracies are calculated from the following formulas:

Repeat Error

$$= \pm \frac{1}{2} \times \frac{\text{Max. measured value} - \text{Min. measured value}}{\text{Maximum scale value}} \times 100 (\%)$$

Voltage Error

$$= \pm \frac{T_v - T_r}{T_r} \times 100 (\%)$$

T_v : Average of measured values at voltage V
 T_r : Average of measured values at the rated voltage

Temperature Error

$$= \pm \frac{T_t - T_{20}}{T_{20}} \times 100 (\%)$$

T_t : Average of measured values at $t^\circ\text{C}$
 T_{20} : Average of measured values at 20°C

Setting Error

$$= \frac{\text{Average of measured values} - \text{Set value}}{\text{Maximum scale value}} \times 100 (\%)$$

Use of External Input (GT5P-P Only)

1. Do not apply voltage to external input terminals 3 and 4. Be sure not to connect external inputs to other terminals because the internal circuit may be damaged.
2. Use reliable mechanical contacts capable of switching approximately 22V DC, 1 mA to close input terminals 3 and 4. (Closed: 1 k Ω maximum, Open: 100 k Ω minimum) The input terminals should not be connected to a ground wire of other devices.
3. Do not install input lines in parallel with high-voltage or motor lines. Use shielded wires or separate conduit for input lines, and make the input lines as short as possible.

Load Current

The rated current of the contact (or control output) should not be exceeded. Especially for inductive, capacitive, and incandescent lamp loads, the inrush current as large as a few to several tens times the rated current may cause welded contacts and other troubles. The amount of inrush current as well as steady-state current must be taken into consideration.

Contact Protection

Switching an inductive load generates a counter-electromotive force in the coil. The counter emf will cause arcing, which may shorten the contact life. Application of a protection circuit is recommended for contact protection.

Rest Time

When turning power off after time-out, allow a rest time of 0.1 sec, and during operation, 1 sec at least.

Power

Since DC types are designed to operate on DC power containing 10% or less ripple, insert a smoothing circuit when using a rectified AC power to operate DC type timers.

Continuous Energizing

Continuous energizing for a long period of time may damage the electrical characteristics of the timer because of internal heating. Use an additional relay to the output circuit and refrain from continuous energizing of the timer.

Dielectric Strength Test

When performing an insulation resistance or dielectric strength test on control panels containing timers, make sure that the dielectric strength of the timer is not exceeded. In case the dielectric strength is exceeded, remove the timers from the panels.

Operating Environment

Temperature and Humidity

Use the timer within the operating temperature and operating humidity ranges and prevent freezing and condensation. After storing below the operation temperature, leave the timer at room temperature for a sufficient period of time before use.

Environment

Prevent a corrosive gas such as sulfurous or ammonia gas, organic solvents (alcohol, benzene, thinner, etc.), strong alkaline substances or strong acids from touching to the timer, and do not use the timer in such an environment. Keep the timer from water splashes or steam.

Vibration and Shock

Since excessive vibrations or shocks cause the output contacts to open, the timer should be used within the operating extremes of vibration and shock resistance. Use of hold-down springs is recommended for secure mounting on sockets.

Others

- Use a mechanical-contact switch or relay to supply power to the time.
- When driving the timer using a solid-state output device such as two-wire proximity switch, photoelectric switch or solid-state relay directly, malfunction may be caused by a leakage current from the solid-state device. Be sure to check thoroughly before using.
- Since AC types (such as A100 and A200) comprise a capacitive load, the SSR dielectric strength should be two or more times as large as the power voltage when switching the timer power using an SSR.
- To make a sequence circuit by connecting timer and relay, check the timer operation sufficiently in consideration of the reset time of the timer.

GE1A series Electronic Timers

Two different time ranges to cover a wide time range

- Large clear knob for easy time range setting
- ON Delay function
- Highly precise time control
- Instant monitoring of operation status by LED indicators.

Applicable Standards	Mark	File No. or Organization
UL508 CSA C22.2 No. 14		UL/c-UL Listed File No. E204716
EN61812-1		EU Low Voltage Directive
		TÜV Product Service



Contact Ratings

Contact Ratings	240V AC/5A, 24V DC/5A (resistive load)
Electrical Life	100,000 operations minimum (resistive load)
Mechanical Life	GE1A-B: 10,000,000 operations minimum GE1A-C: 5,000,000 operations minimum

Time Ranges

Time Range Code	Magnification	Time Range
10H	1S	0.1 sec. to 1 sec.
	10S	1 sec. to 10 sec.
	1M	0.1 min. to 1 min.
	10M	1 min. to 10 min.
	1H	0.1 hour to 1 hour
30H	10H	1 hour to 10 hours
	1S	0.3 sec. to 3 sec.
	10S	3 sec. to 30 sec.
	1M	0.3 min. to 3 min.
	10M	3 min. to 30 min.
1H	0.3 hour to 3 hour	
10H	3 hour to 30 hours	

10H



30H



Time Range	Rated Voltage	Part No.	
		Contact	
		Delayed SPDT + Instantaneous SPDT	Delayed DPDT
10H (0.1 sec. to 10 hours)	220 to 240V AC	GE1A-B10HA220	GE1A-C10HA220
	200 to 220V AC	GE1A-B10HA200	GE1A-C10HA200
	110 to 120V AC	GE1A-B10HA110	GE1A-C10HA110
	100 to 110V AC	GE1A-B10HA100	GE1A-C10HA100
	24V AC/DC	GE1A-B10HAD24	GE1A-C10HAD24
30H (0.3 sec. to 30 hours)	220 to 240V AC	GE1A-B30HA220	GE1A-C30HA220
	200 to 220V AC	GE1A-B30HA200	GE1A-C30HA200
	110 to 120V AC	GE1A-B30HA110	GE1A-C30HA110
	100 to 110V AC	GE1A-B30HA100	GE1A-C30HA100
	24V AC/DC	GE1A-B30HAD24	GE1A-C30HAD24

Part No. Development

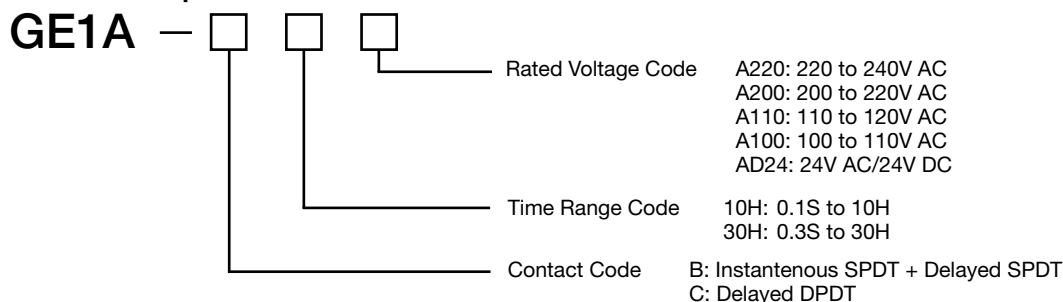

Specifications

Model		GE1A-B	GE1A-C
Operation Mode		ON Delay	
Time Range		0.1 second to 30 hours	
Rated Operational Voltage		220V to 240V AC, 200 to 220V AC, 110V to 120V AC, 100 to 110V AC, 24V AC/DC	
Voltage Tolerance		AC: 85 to 110%, DC: 90 to 110%	
Operating Temperature		-10 to +55°C (without freezing)	
Storage Temperature		-30 to +70°C (without freezing)	
Operating Humidity		35 to 85% RH (without condensation)	
Repeat Error		±0.2% ±10 ms maximum	
Voltage Error		±0.5% ±10 ms maximum	
Temperature Error		±3% maximum	
Setting Error		±10% maximum	
Insulation Resistance		100 MΩ minimum (500V DC megger)	
Dielectric Strength	Between power and output terminals	2,000V AC, 1 minute	
	Between contact circuits	750V AC, 1 minute	
	Between contact circuits (opposite pole)	2,000V AC, 1 minute	
Vibration Resistance		Damage limits: Amplitude 0.75 mm, 10 to 55 Hz Operating extremes: Amplitude 0.5 mm, 10 to 55 Hz	
Shock Resistance	Damage limits	Panel mount: 490 m/s ² (approx. 50G) Surface mount: 249 m/s ² (approx. 25G)	
	Operating extremes	98 m/s ² (approx. 10G)	
Power Consumption	220V AC	7.7 VA (60 Hz), 6.6 VA (50 Hz)	8.0 VA (60 Hz), 7.0 VA (50 Hz)
	200V AC	7.0 VA (60 Hz), 6.0 VA (50 Hz)	8.0 VA (60 Hz), 7.0 VA (50 Hz)
	110V AC	3.8 VA (60 Hz), 3.3 VA (50 Hz)	3.5 VA (60 Hz), 3.0 VA (50 Hz)
	100V AC	3.5 VA (60 Hz), 3.0 VA (50 Hz)	3.5 VA (60 Hz), 3.0 VA (50 Hz)
	24V AC	1.6 VA	2.0 VA
	24V DC	1.0W	0.8W
Weight (Approx.)		101g	95g

GE1A-B

Item	Terminal No.	Operation
Power	2-7 (Power)	
	5-8 (NC)	
Delayed Contact	6-8 (NO)	
	1-4 (NC)	
Instantaneous Contact	1-3 (NO)	
	POWER	
LED Indicator	OUT	

GE1A-C

Item	Terminal No.	Operation
Power	2-7 (Power)	
	1-4, 5-8 (NC)	
Delayed Contact	1-3, 6-8 (NO)	
	POWER	
LED Indicator	OUT	

Internal Connections

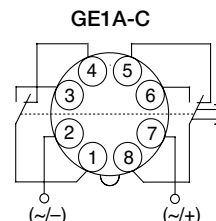
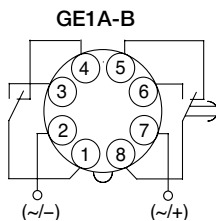

Dimensions

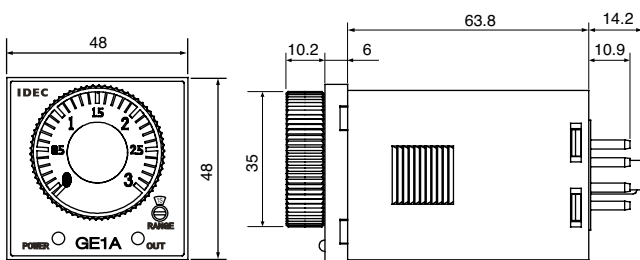

Panel Cut-out

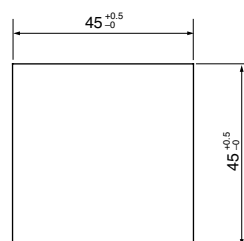

GE1A Series Electronic Timers

Applicable Sockets

SR2P-05A (not UL/c-UL listed)

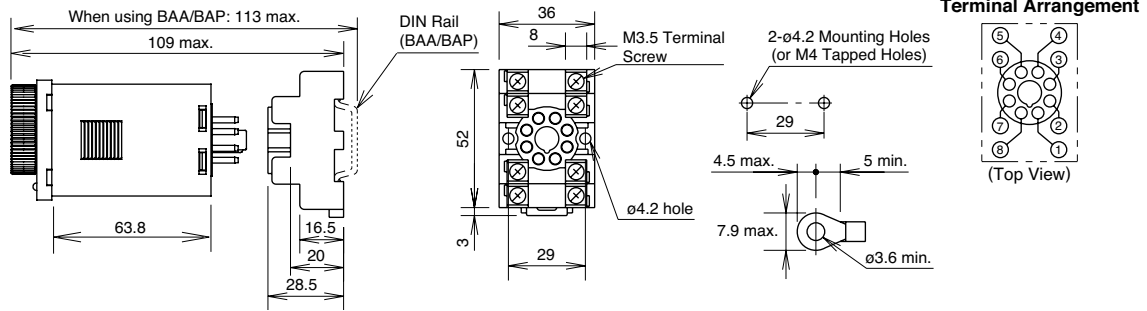

SR2P-06A

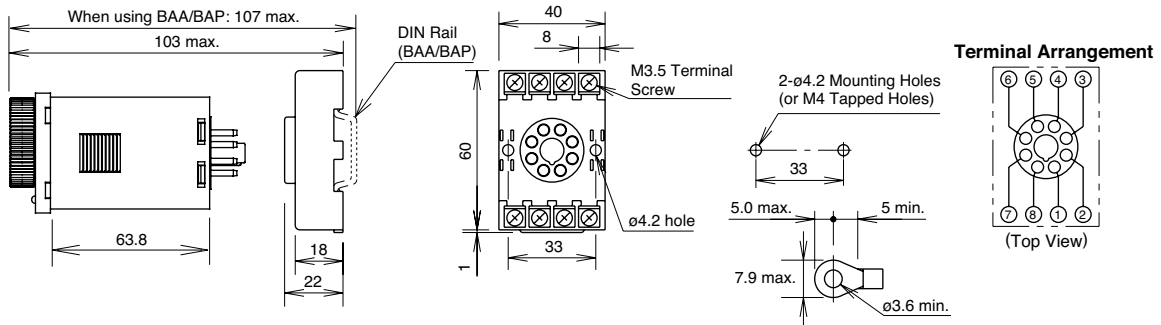

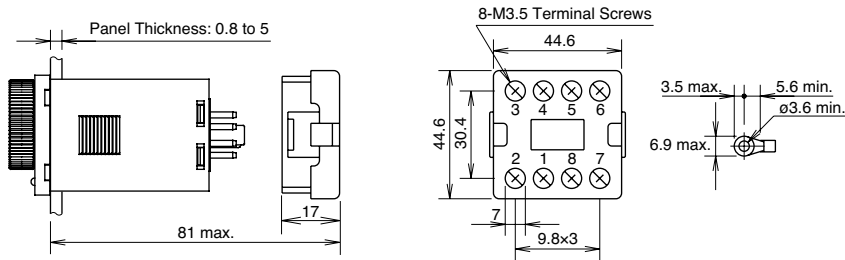

SR6P-M08G



All dimensions in mm.

Accessories

Name	Shape	Part No.
Panel Mount Adapter		GE9Z-AD
Dust Cover		GE9Z-C48

IDEC CORPORATION

 www.idec.com

Head Office

6-64, Nishi-Miyahara-2-Chome, Yodogawa-ku, Osaka 532-0004, Japan

USA	IDEC Corporation	Tel: +1-408-747-0550	opencontact@idec.com	Hong Kong	IDEC Izumi (H.K.) Co., Ltd.	Tel: +852-2803-8989	info@hk.idec.com
Germany	APEM GmbH	Tel: +49-40-25 30 54 - 0	service@eu.idec.com	China/Shanghai	IDEC (Shanghai) Corporation	Tel: +86-21-6135-1515	idec@cn.idec.com
Singapore	IDEC Izumi Asia Pte. Ltd.	Tel: +65-6746-1155	info@sg.idec.com	China/Shenzhen	IDEC (Shenzhen) Corporation	Tel: +86-755-8356-2977	idec@cn.idec.com
Thailand	IDEC Asia (Thailand) Co., Ltd	Tel: +66-2-392-9765	sales@th.idec.com	China/Beijing	IDEC (Beijing) Corporation	Tel: +86-10-6581-6131	idec@cn.idec.com
Australia	IDEC Australia Pty. Ltd.	Tel: +61-3-8523-5900	sales@au.idec.com	Japan	IDEC Corporation	Tel: +81-6-6398-2527	marketing@idec.co.jp
Taiwan	IDEC Taiwan Corporation	Tel: +886-2-2698-3929	service@tw.idec.com				

Specifications and other descriptions in this brochure are subject to change without notice.
2018 IDEC Corporation, All Rights Reserved.

EP1428-8 AUGUST 2018

