

5

4

3

2

1

Hood lower part

Hood upper part

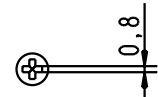
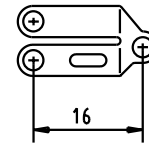
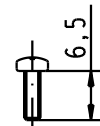
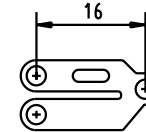
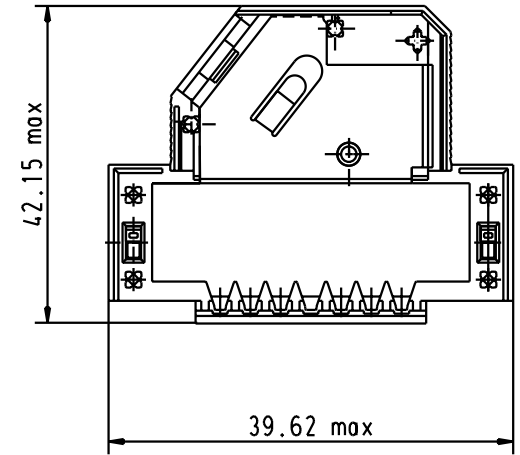
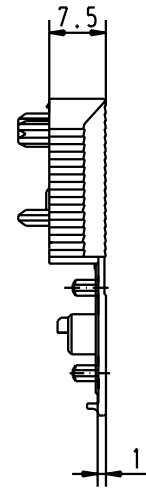
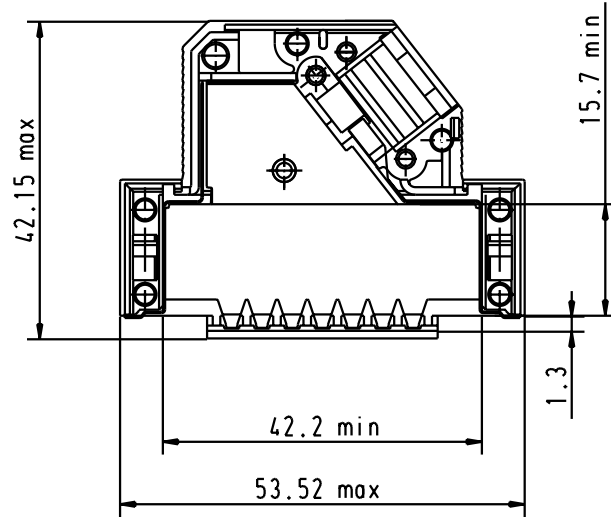
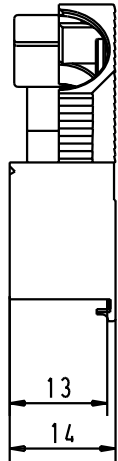

Strain relief 1    Strain relief 2



Flathead screws

D

C

B

A

				Det.	27/02/03	Name	S.H.	 All Dim. in mm Orig. Size DIN A 4	D-Sub Hoods 25 POLES SHIELDED	Maßstab/ Scale
			Insp.							
			Stand.							
31392	27/02/03	S.H.	HARTING ELEKTRONIK F-95972 Paris				TB 09 67 025 0573	Blatt/ Page		
Mod.	Det.	Name					Sub.			