

1 2 3 4 5 6

A

B

C

D

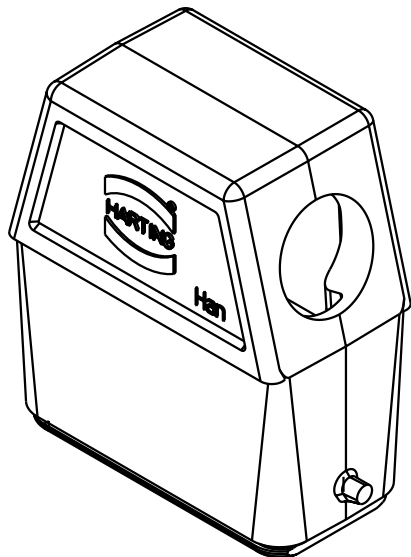
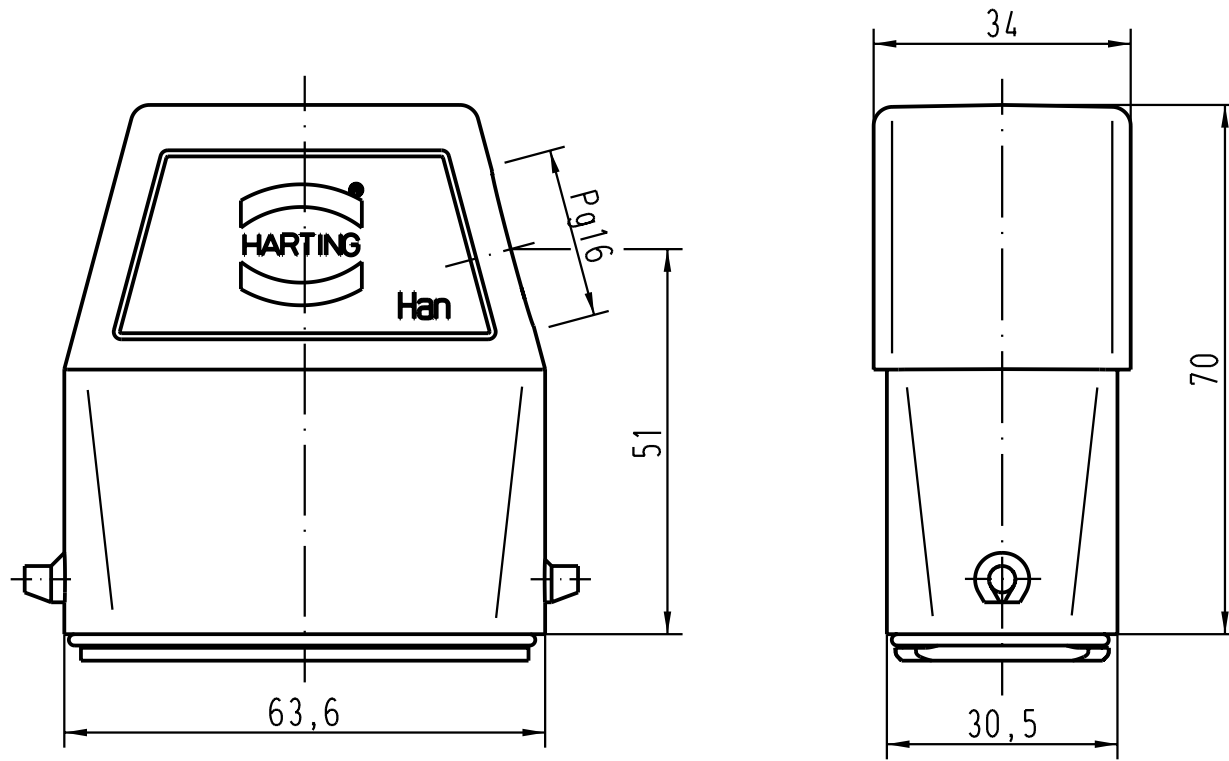

All Dimensions in mm Original Size DIN A 4		Techn. Character.			Nicht tolerierte Masse/ Free size tolerances	
			Dat.	Name	Massstab/ Scale 1 : 1	Han 15EMV-gs-16 Topfgehäuse/ hoods
			Detail.	18.05.04 Loe.		
			Insp.	KR		
			Stand.			
411037			HARTING Electric GmbH & Co. KG			TB 09 62 015 0540 Sub. TB 09 62 015 054. v. 30.08.95
Mod.	Dat.	Name	D-32339 Espelkamp			
						Blatt/ page