

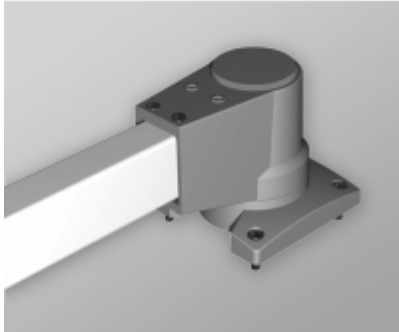

Quality Products. Service Excellence.

Tara Plus Socket Joint *TPSSSJ Series*



- Accepts 60x40mm rectangular tube parallel to its mounting surface.
- Die-cast Aluminum G Al Si 12.
- Integrated movement stop.
- Service free bearings.
- Rotates 300°.
- Adjustment screws (red screws).
- Accessible from the top.



Hole Pattern

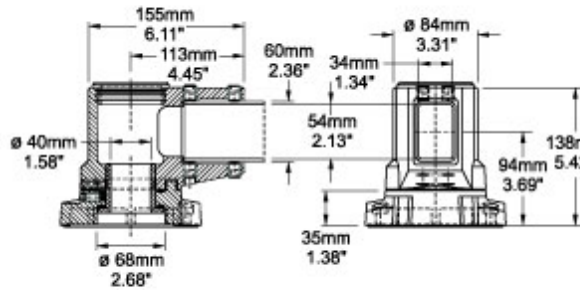
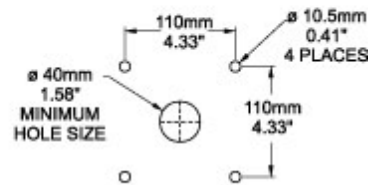

Front Section Socket Joint

End View

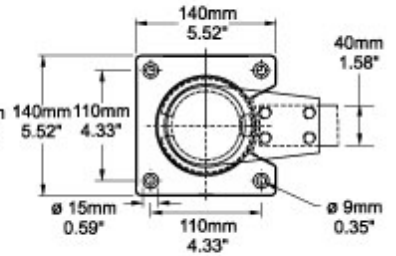

TopView

Part No. **R149-005-000**

Data subject to change without notice

© 2020. Hammond Manufacturing Ltd. All rights reserved.