

SP7685EB Evaluation Board Manual

- 2.7V to 4.2V Input Range
- Typical 200mA Torch or 1000mA Flash Output Current
- High Efficiency in 1X mode, high V_{OUT} in 2X mode
- Small 3x3mm 10-Pin DFN Package
- 2.4MHz Switching Frequency Enables Small Components
- Integrated Design with Minimal Components
- Use with 1 cell Lithium Ion Battery

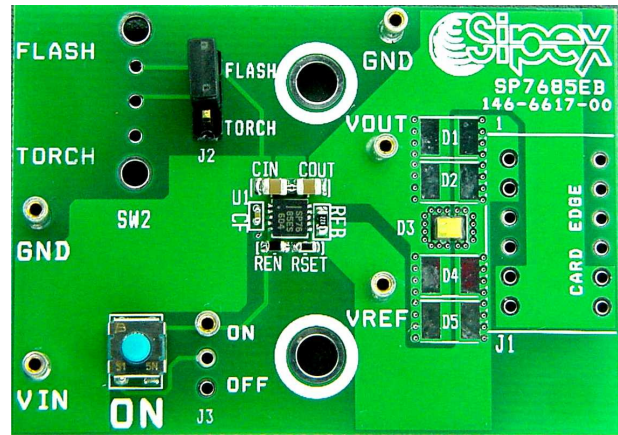

DESCRIPTION AND BOARD SCHEMATIC

The **SP7685EB Evaluation Board** is a compact circuit including the SP7685 in 3x3mm DFN and 3 small 0603 capacitors which can provide a stable drive current for a 1W LED such as the Lumi-LEDs Luxeon I or PWF1 type light sources. The evaluation board is a completely assembled and tested surface mount board which provides easy probe access points to all SP7685 inputs and outputs so that the user can quickly connect and measure electrical characteristics and waveforms.

SP7685EB Schematic

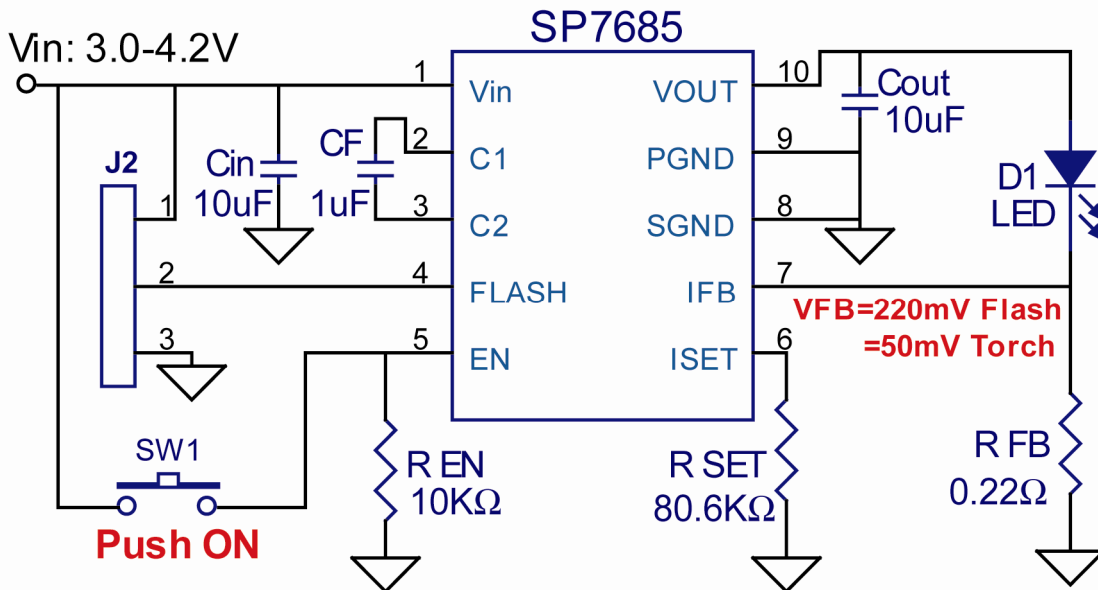

TO GET STARTED:

1. Connect VIN from VIN to GND (VIN range 2.7V to 4.2V).
2. Select mode between TORCH and FLASH by putting jumper into corresponding position.
3. Apply High to ON terminal to turn the LED on.

POWER SUPPLY DATA

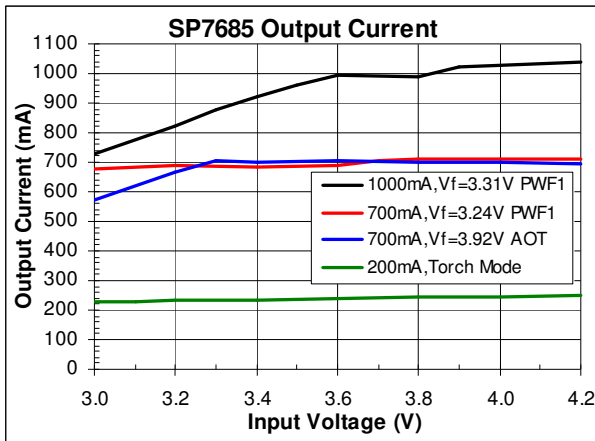

Figure 1. Output Current

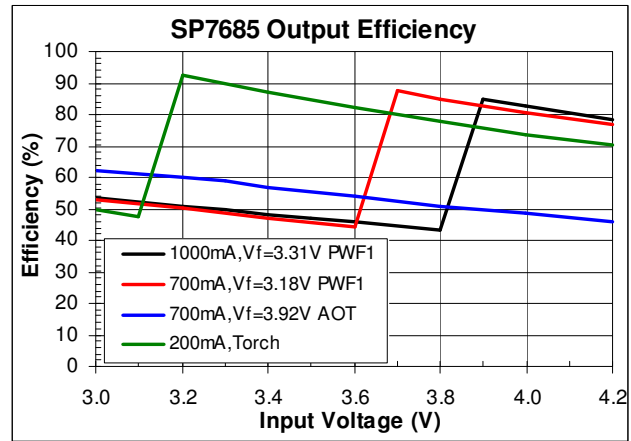

Figure 2. Output Efficiency

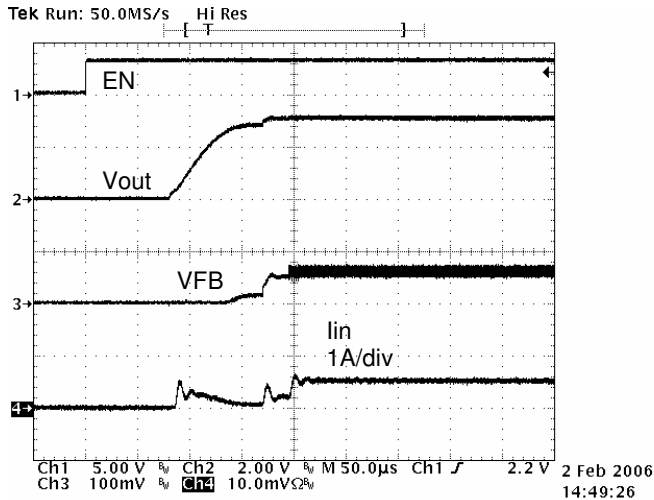

Figure 3. Startup 200mA Torch, W/PWF1

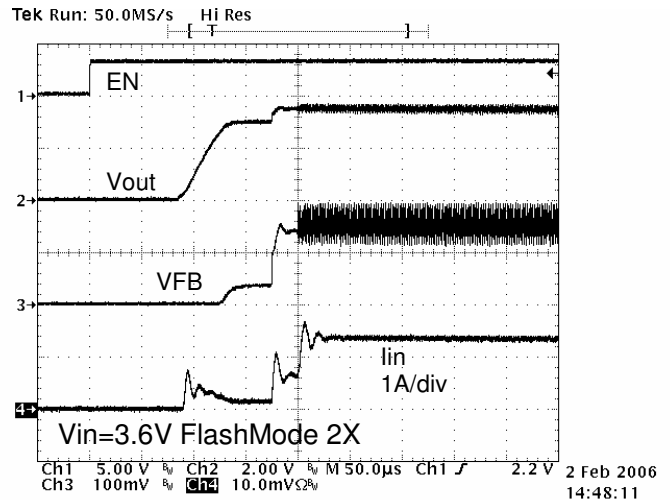

Figure 4. Startup 700mA Flash, W/PWF1

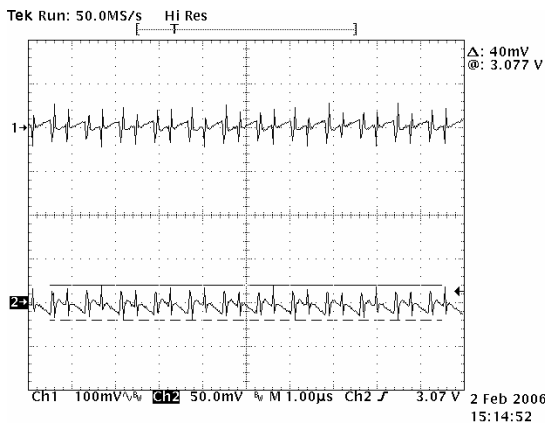

Figure 5. Ripple 200mA Torch, Vin=3.6V, W/PWF1

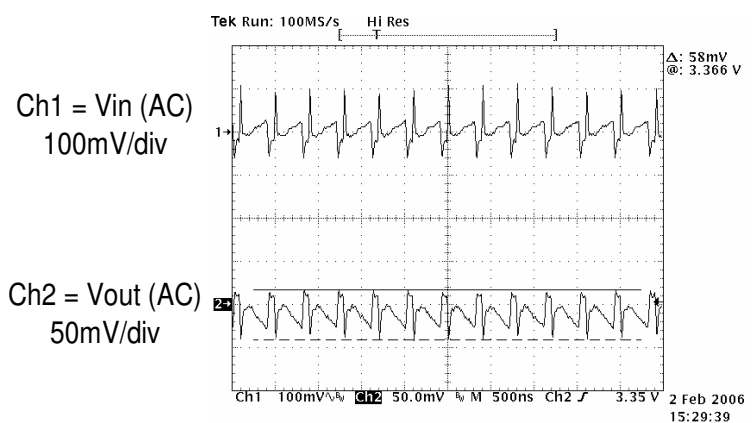

Figure 6. Ripple 700mA Flash, Vin=4.2V, W/PWF1

EVALUATION BOARD LAYOUT

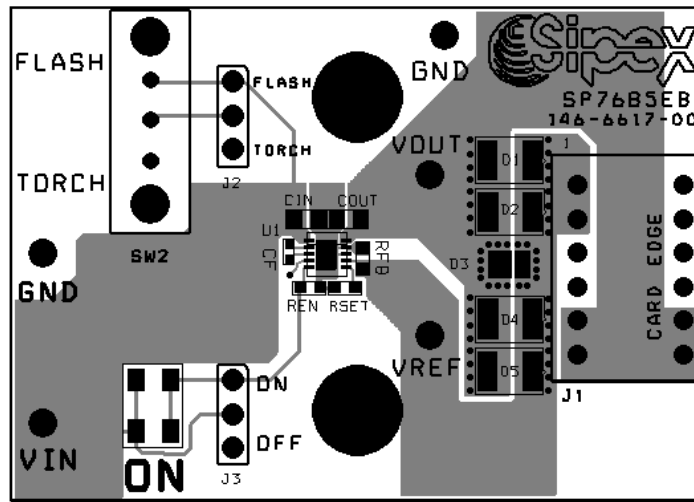

FIGURE 7: SP7685EB COMPONENT PLACEMENT

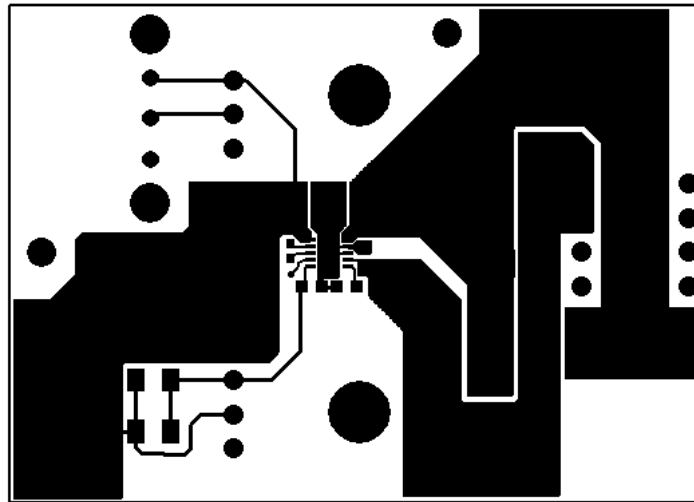

FIGURE 8: SP7685EB PC LAYOUT TOP SIDE

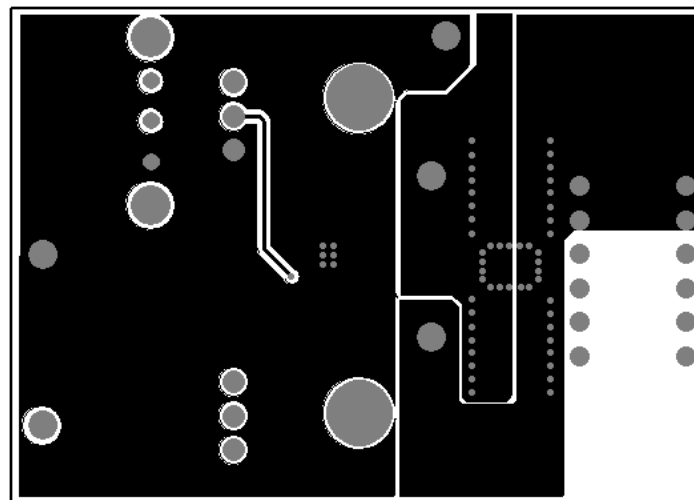

FIGURE 9: SP7685EB PC LAYOUT BOTTOM SIDE

TABLE1: SP7685EB LIST OF MATERIALS

Part Reference	Part Number	Value	Size	Manufacturers/ Website
U1	SP7685ER		3x3mm DFN - 10 pin	Sipex/www.sipex.cpm
CIN, COUT	GRM21BR60J106KE19L	10uF/6.3V	0805	Murata/www.murata.com
CF	GRM155R60J105KE19B	1uF/6.3V	0402	Murata/www.murata.com
REN	CRCW0603103J	10K	0603	Vishay
RSET	CRCW06038062F	80.6K	0603	Vishay
RFB	CRCW0603R220J	0.22ohms	0603	Vishay
SW1	7914J-1-000	Push button Switch	4.8x5.0mm	Bourn Inc.
J2	PTC36SAAN	3-Pin Header	0.23x0.12"	Sullins
	STC02SYAN	Shunt	0.2x0.1"	Sullins
TP(VIN,GND,VOUT&VREF)	0300-11501-4727100	Test point female pin	.042" Dia	Mil-Max (digi-key)

ORDERING INFORMATION

Model	Temperature Range	Package Type
SP7685EB.....	-40°C to +85°C.....	SP7685EB Evaluation Board
SP7685ER.....	-40°C to +85°C.....	10-pin 3x3 DFN