

FM Fan Mounts

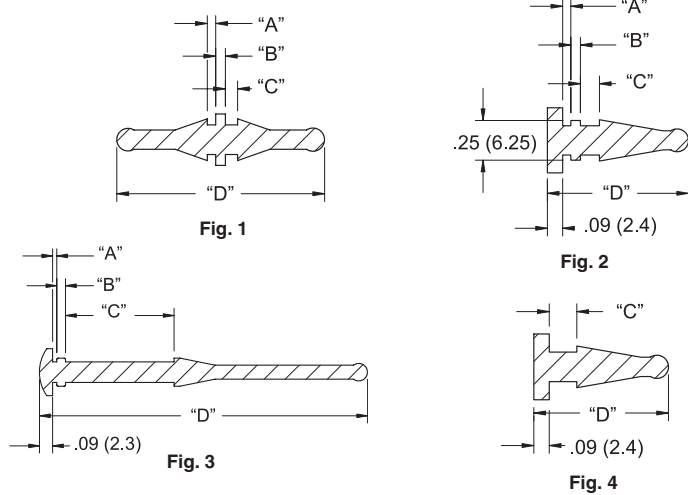
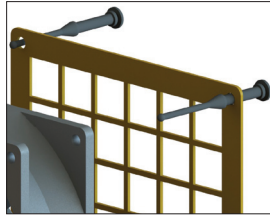
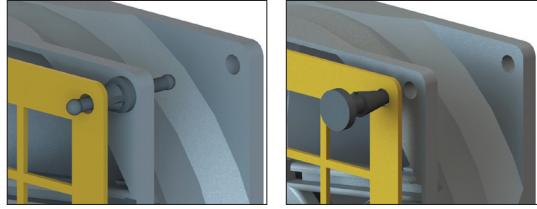

- Fast mounting of fans eliminating the need for screws
- May reduce noise caused by the vibration of the fan
- Color: Black

Item No.	Fig.	Hole Ø x 2	Fan Thickness	Max. Panel Thickness	Material	"A"	"B"	"C"	"D"	Bulk Pack Qty.
FM-1	1	.197 (5)	.079 (2)	.055 (1.4)	EPDM Rubber, 30 Shore A	0.5 (1.3)	.06 (1.5)	.07 (1.9)	1.27 (32.3)	1,000
FM-2	1	.197 (5)	.079 (2)	.055 (1.4)	EPDM Rubber, 40 Shore A	0.5 (1.3)	.06 (1.5)	.07 (1.9)	1.27 (32.3)	1,000
FM-3	2	.197 (5)	.122 (3.1)	.055 (1.4)	EPDM Rubber, 30 Shore A	0.5 (1.3)	.06 (1.5)	.12 (3)	.88 (22.2)	1,000
FM-4	2	.197 (5)	.122 (3.1)	.055 (1.4)	EPDM Rubber, 40 Shore A	0.5 (1.3)	.06 (1.5)	.12 (3)	.88 (22.2)	1,000
FM-5	3	.138 (3.5)	.787 (20)	.031 (0.8)	Silicone Rubber, 40 Shore A	.03 (0.7)	.06 (1.5)	.73 (18.5)	2.20 (56)	1,000
FM-6	3	.161 (4.3)	.591 (15)	.118 (3)	Silicone Rubber, 40 Shore A	.10 (2.5)	.08 (2)	.55 (14)	2.12 (53.8)	1,000
FM-7	3	.138 (3.5)	.98 - 1.10 (25 - 28)	.031 (0.8)	Silicone Rubber, 40 Shore A	.03 (0.7)	.06 (1.5)	.94 (24)	2.87 (73)	1,000
FM-8	4	.197 (5)	.213 (5.4) *	.031 (0.8)	EPDM Rubber, 30 Shore A	N/A	N/A	.17 (4.3)	.83 (21)	1,000
FM-9	4	.197 (5)	.213 (5.4) *	.031 (0.8)	EPDM Rubber, 40 Shore A	N/A	N/A	.17 (4.3)	.83 (21)	1,000

* Total thickness of Panel and Fan combined

FMB Break Away Fan Mount

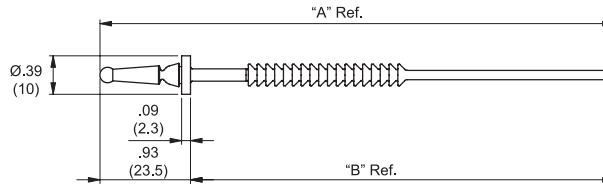
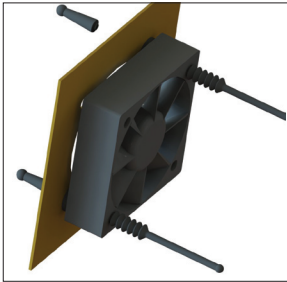

- Evenly spaced flexible ribs allow mounting fans of many different heights
- Pull-through, break away installation tabs ease installation, especially in blind corners
- Pull-tab breaks away cleanly after installation for low profile panels
- Easy Assembly when mounting in restricted spaces
- To save space, end can be cut off after mounting
- Material: UL94 HB Silicone Rubber 40 Shore A
- Color: Black

Item No.	"A" Ref.	"B" Ref.	Fan Hole Ø	Fan Thickness	Panel Hole Ø	Panel Thickness	Bulk Pack Qty.
FMB-1	5.26 (133.5)	4.33 (110)	.18-.20 (4 - 4.5)	.98-2.01 (25 - 51)	.18-.20 (4.5 - 5)	.03-.06 (0.8 - 1.6)	1,000
FMB-2	3.29 (83.5)	2.36 (60)	.13-.14 (3.2 - 3.5)	Up to .40 (10)	.18-.20 (4.5 - 5)	.03-.06 (0.8 - 1.6)	1,000
			.16-.18 (4 - 4.5)	Up to .98 (25)			

FMM Multi Fan Mount

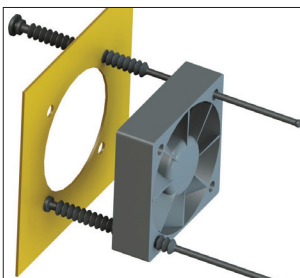

Patent Pending

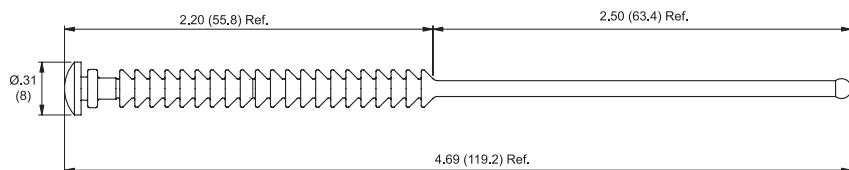

- One piece design fits all industry standard DC fans from .39-2.00 (10-51) thick
- Easy assembly when mounting in restricted spaces
- To save space, end can be cut off after mounting
- Material: UL94 HB Silicone Rubber 40 Shore A
- Color: Black

Item No.	Fan Thickness	Fan Hole Ø	Panel Thickness	Panel Hole Ø	Bulk Pack Qty.
FMM-1	.39 - 2.00 (10 - 51)	.126 - .177 (3.2 - 4.5)	.039 - .059 (1 - 1.5)	.177 - .189 (4.5 - 4.8)	500