

**SERIES: VMS-550 | DESCRIPTION: AC-DC POWER SUPPLY**
**FEATURES**

- up to 550 W continuous power
- -40°C to 70°C operating temperature
- industry standard foot print 3" x 5"
- low profile 1.5"
- power factor correction
- 12 V/0.5 A fan output
- standby power <0.5 W
- efficiency up to 92%
- long life electrolytic capacitors
- complying with the latest EMI standard IEC 60601-1-2:2014 (4<sup>th</sup> edition)

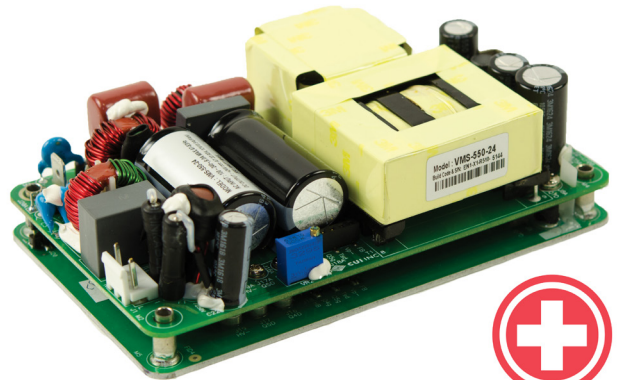

| MODEL      | output voltage | output current | output power <sup>1,2</sup> | ripple and noise <sup>3,4</sup> | efficiency |
|------------|----------------|----------------|-----------------------------|---------------------------------|------------|
|            | (Vdc)          | max (A)        | max (W)                     | max (mVp-p)                     | typ (%)    |
| VMS-550-12 | 12             | 41.67          | 500                         | 240                             | 90         |
| VMS-550-15 | 15             | 33.33          | 500                         | 300                             | 90         |
| VMS-550-24 | 24             | 22.92          | 550                         | 240                             | 91         |
| VMS-550-30 | 30             | 18.33          | 550                         | 300                             | 91         |
| VMS-550-48 | 48             | 11.46          | 550                         | 480                             | 92         |
| VMS-550-58 | 58             | 9.48           | 550                         | 580                             | 92         |

Notes:

1. Maximum output power with 21 CFM forced air cooling. See derating curves for full performance details.
2. Combined output power of main output and fan supply shall not exceed the max power rating.
3. Ripple is peak to peak with 20 MHz bandwidth and 10  $\mu$ F tantalum capacitor in parallel with a 0.1  $\mu$ F capacitor at rated line voltage and load ranges.
4. Output ripple can be more than 10% of the output voltage at -40°C.
5. All specifications are measured at Ta=25°C, nominal input voltage, and rated output load unless otherwise specified.

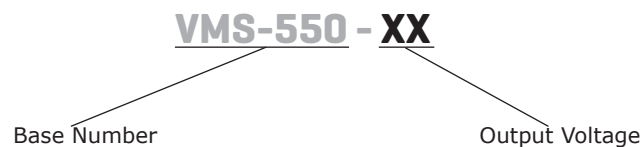
**PART NUMBER KEY**

## INPUT

| parameter                 | conditions/description                         | min  | typ    | max        | units    |
|---------------------------|--|------|--------|------------|----------|
| voltage                   |  | 90   |        | 264        | Vac      |
| frequency                 |  | 47   |        | 63         | Hz       |
| current                   | at 115 Vac, full load<br>at 230 Vac, full load |      | 6<br>3 |            | A<br>A   |
| inrush current            | at 230 Vac, cold start                         |      |        | 45         | A        |
| leakage current           | at 115 Vac<br>at 230 Vac                       |      |        | 0.2<br>0.4 | mA<br>mA |
| touch current             |  |      |        | 0.1        | mA       |
| power factor              | at full load                                   | 0.95 |        |            |          |
| no load power consumption |  |      |        | 0.7        | W        |
| input fuse                | 8 A/250 V time delay fuse (included)           |      |        |            |          |

## OUTPUT

| parameter                  | conditions/description  | min | typ   | max | units |
|----------------------------|---|-----|-------|-----|-------|
| initial set point accuracy |   |     | ±1    |     | %     |
| line regulation            |   |     | ±0.5  |     | %     |
| load regulation            | from 100% to 10% load   |     | ±1    |     | %     |
| start-up delay time        |   |     | 2     |     | s     |
| rise time                  | at 115/230 Vac  |     | 55    |     | ms    |
| hold-up time               | at 115/230 Vac, full load   |     | 16    |     | ms    |
| adjustability              | built in trim pot   |     | ±3    |     | %     |
| switching frequency        |   | 50  |       | 300 | kHz   |
| transient response         | 25% step load change, at 0.1 A/μS slew rate, 50% duty cycle, 50/60 Hz, max excursion 4%, recovery time 5 ms |     |       |     |       |
| temperature coefficient    | at 0~50°C   |     | ±0.05 |     | %/°C  |
| fan output <sup>1</sup>    | 12 Vdc / 500 mA   |     |       |     |       |

Notes: 1. Fan supply output voltage tolerance including set point accuracy, line and load regulation is ±10% and ripple and noise is less than 10%.

## PROTECTIONS

| parameter                   | conditions/description  | min | typ | max | units |
|-----------------------------|---|-----|-----|-----|-------|
| over voltage protection     | hiccup, auto recovery   | 110 |     | 140 | %     |
| over current protection     | hiccup, auto recovery   | 110 |     |     | %     |
| short circuit protection    | hiccup, auto recovery   |     |     |     |       |
| over temperature protection | goes into hiccup mode when the temperature of the PCB exceeds 110±10°C, auto recovery |     |     |     |       |

## SAFETY & COMPLIANCE

| parameter         | conditions/description  | min | typ                     | max | units             |
|-------------------|---|-----|-------------------------|-----|-------------------|
| isolation voltage | input to output (2 x MOPP)<br>input to ground (1 x MOPP)<br>output to ground  |     | 4,200<br>1,500<br>1,500 |     | Vac<br>Vac<br>Vac |
| safety approvals  | IEC 60601-1: 2005 +CORR1:2006<br>+CORR2:2007 +AM1:2012, EN 60601-1:2006<br>+A11:2011 +A1:2013, ANSI/AAMI ES 60601-1<br>(2005+CI:09+A2:10), AMD1:2012 CAN/CSA-<br>C22.2 No 60601-1 (2008) 60601-1:14 ISO 14971,<br>2nd edition complies with LVD directive |     |                         |     |                   |
| safety class      | class I   |     |                         |     |                   |

Notes: 2. The power supply is considered a component which will be installed into final equipment. The final equipment still must be tested to meet the necessary EMC directives.

## SAFETY & COMPLIANCE

| parameter                          | conditions/description  | min | typ       | max | units |
|------------------------------------|---|-----|-----------|-----|-------|
| conducted emissions                | EN 55011 Class B  |     |           |     |       |
| radiated emissions                 | EN 55011 Class B (to be controlled in end system with external core (King core K5B RC 25 x 12 x 15-M in input cable (5 turns))) |     |           |     |       |
| input current harmonics            | EN 61000-3-2, class D   |     |           |     |       |
| voltage fluctuation and flicker    | EN 61000-3-3, pass  |     |           |     |       |
| ESD immunity                       | EN 61000-4-2, level 4, criterion A  |     |           |     |       |
| radiated field immunity            | EN 61000-4-3, level 4, criterion A  |     |           |     |       |
| electrical fast transient immunity | EN 61000-4-4, level 4, criterion A  |     |           |     |       |
| surge immunity                     | EN 61000-4-5, level 4, criterion A  |     |           |     |       |
| conducted immunity                 | EN 61000-4-6, level 4, criterion A  |     |           |     |       |
| magnetic field immunity            | EN 61000-4-8, level 4, criterion A  |     |           |     |       |
| voltage dips, interruptions        | EN 61000-4-11, criterion A & B  |     |           |     |       |
| MTBF                               | as per Telcordia-SR332-issue 3  |     | 3,370,000 |     | hours |
| RoHS                               | 2011/65/EU  |     |           |     |       |

Notes: 1. The power supply is considered a component which will be installed into final equipment. The final equipment still must be tested to meet the necessary EMC directives.

## ENVIRONMENTAL

| parameter             | conditions/description | min | typ | max    | units |
|-----------------------|------------------------|-----|-----|--------|-------|
| operating temperature | see derating curves    | -40 |     | 70     | °C    |
| storage temperature   |                        | -40 |     | 85     | °C    |
| operating humidity    | non-condensing         | 20  |     | 90     | %     |
| storage humidity      | non-condensing         | 20  |     | 90     | %     |
| operating altitude    |                        |     |     | 16,000 | ft    |

## DERATING CURVES

Output Power vs. Input Voltage

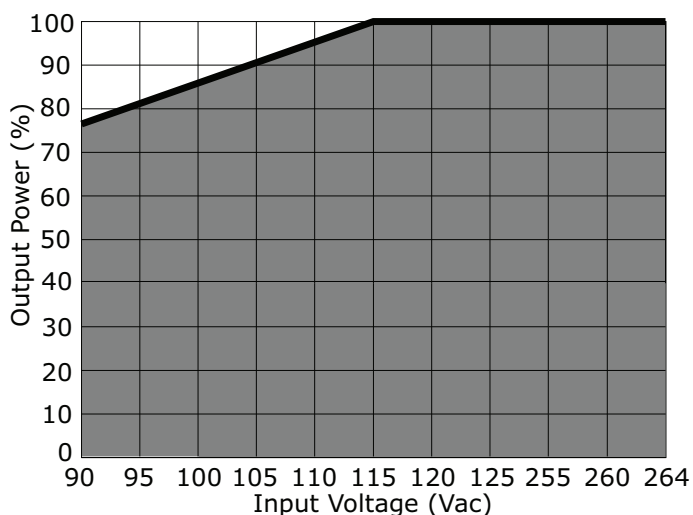

12, 15 Vdc Output Models  
Output Power vs. Ambient Temperature

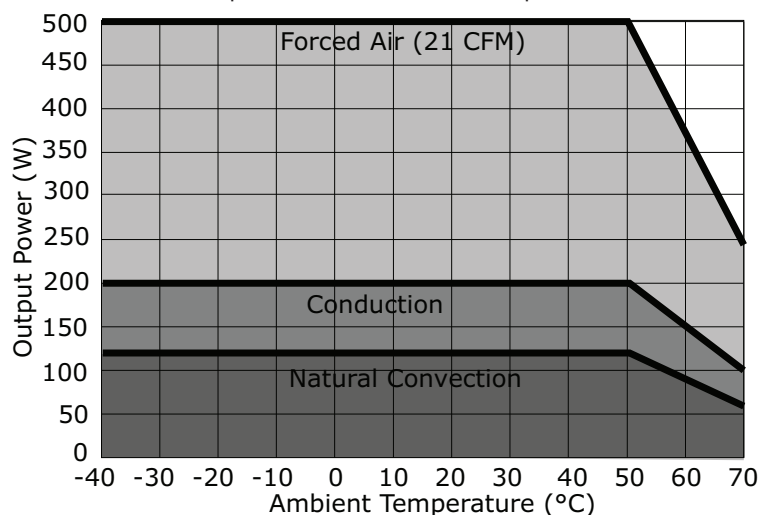

## DERATING CURVES (CONTINUED)

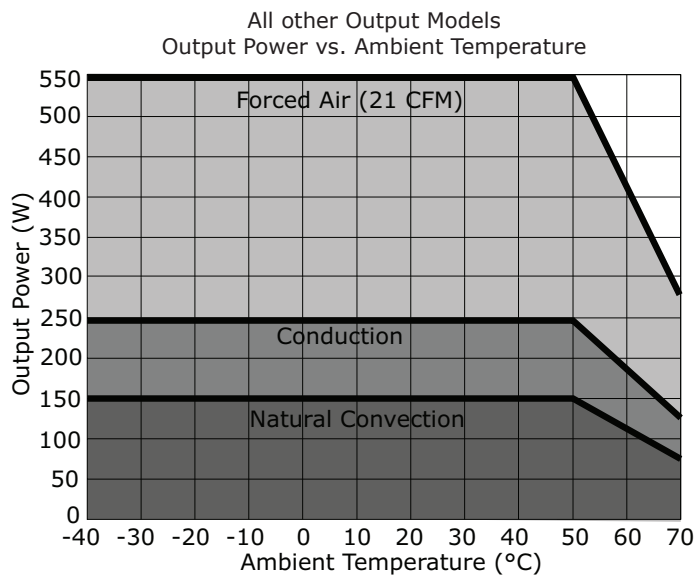

## MECHANICAL

| parameter           | conditions/description   | min | typ | max | units |
|---------------------|--|-----|-----|-----|-------|
| dimensions          | 5.00 x 3.00 x 1.50 (127.00 x 76.20 x 38.10 mm)   |     |     |     | inch  |
| weight              |  |     | 400 |     | g     |
| cooling             | external fan or conduction plate   |     |     |     |       |
| J1 input connector  | Mates with JST housing VHR-3M; pins SVH-41T-P1.1 or equivalent   |     |     |     |       |
| J2 output connector | Accepts ring tongue terminal AMP 8-31886-1 for max 16 AWG wire up to 11 A. Use multiple terminals for higher currents. |     |     |     |       |
| J3 fan connector    | Mates with Tyco 640440-2   |     |     |     |       |

## MECHANICAL DRAWING

units: inch [mm]  
tolerance: ±0.04 [±1.0]

| J1  |          |
|-----|----------|
| PIN | Function |
| 1   | L        |
| 2   | NC       |
| 3   | N        |

| J2  |          |
|-----|----------|
| PIN | Function |
| 1   | +VE      |
| 2   | -VE      |

| J3  |          |
|-----|----------|
| PIN | Function |
| 1   | +FAN     |
| 2   | -FAN     |

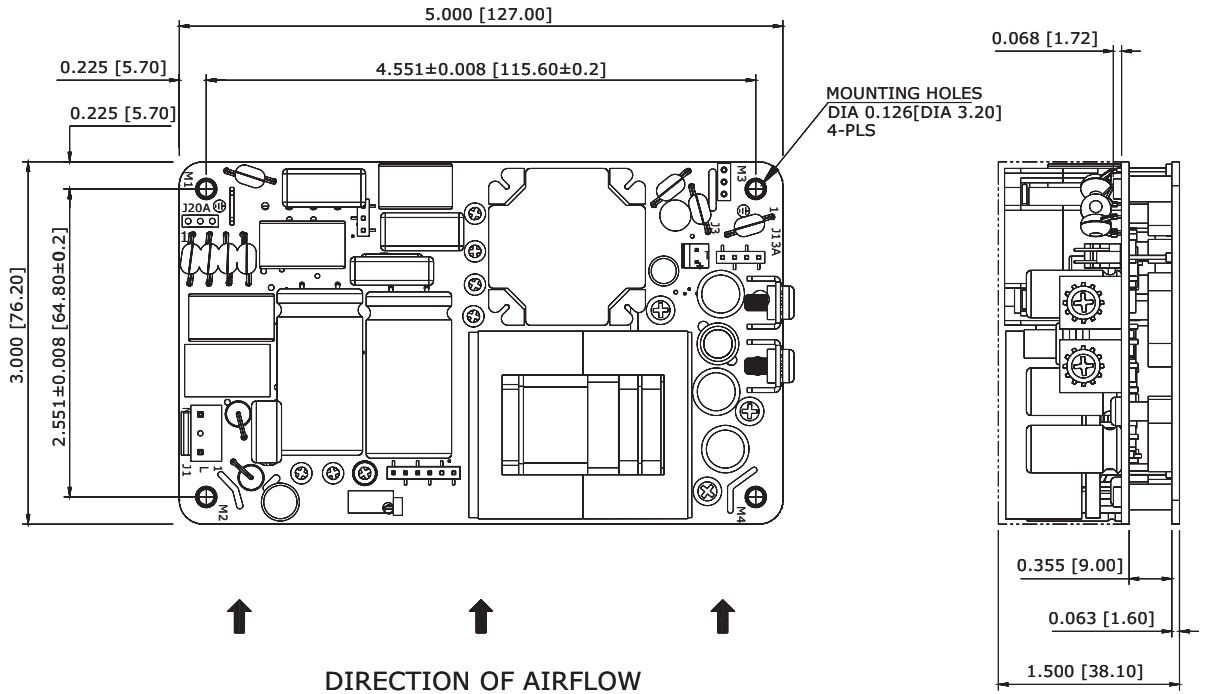

## RECOMMENDED CONDUCTION PLATE AND CLEARANCE

The conduction power rating referenced in the derating curves is with additional aluminum base plate of 3 mm thickness with 177.8 mm (7") length & 101.6 mm (4") width. Clearance of minimum 15 mm above the component height is recommended for better thermal management.

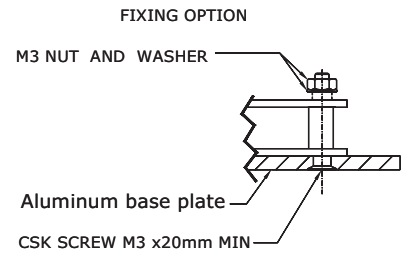
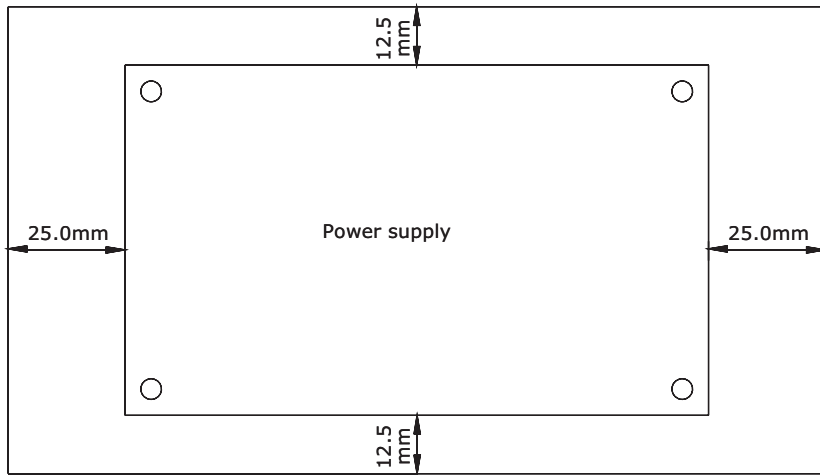
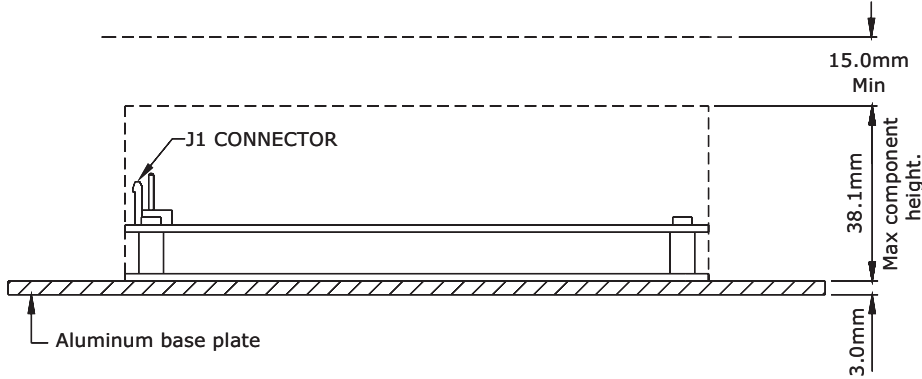

## MOUNTING OPTIONS

### FIXING OPTION -1

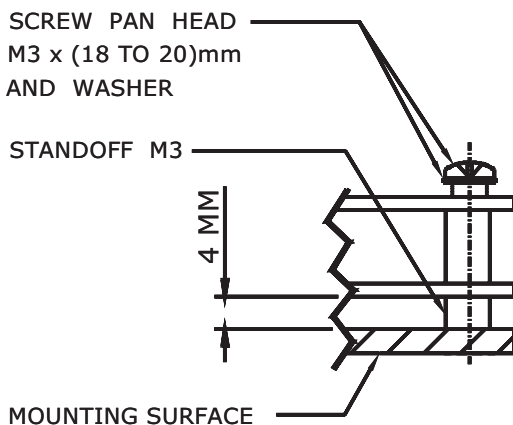

### FIXING OPTION -2

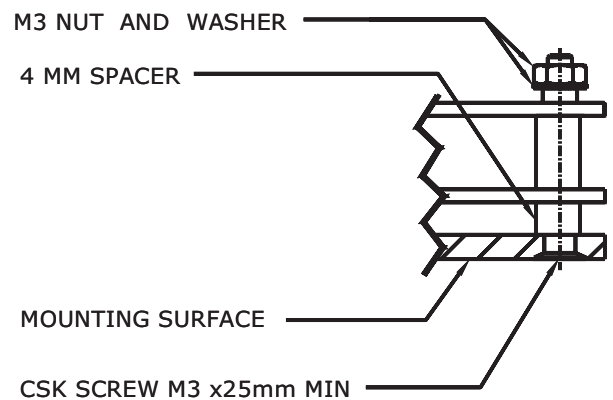

## REVISION HISTORY

---

| rev. | description     | date       |
|------|-----------------|------------|
| 1.0  | initial release | 09/05/2017 |

The revision history provided is for informational purposes only and is believed to be accurate.

**CUI INC<sup>®</sup>**

**Headquarters**  
20050 SW 112th Ave.  
Tualatin, OR 97062  
**800.275.4899**

Fax 503.612.2383  
**cui.com**  
techsupport@cui.com

CUI offers a two (2) year limited warranty. Complete warranty information is listed on our website.

CUI reserves the right to make changes to the product at any time without notice. Information provided by CUI is believed to be accurate and reliable. However, no responsibility is assumed by CUI for its use, nor for any infringements of patents or other rights of third parties which may result from its use.

CUI products are not authorized or warranted for use as critical components in equipment that requires an extremely high level of reliability. A critical component is any component of a life support device or system whose failure to perform can be reasonably expected to cause the failure of the life support device or system, or to affect its safety or effectiveness.