

Thermally-Enhanced High Power RF LDMOS FET 180 W, 2110 – 2170 MHz

Description

The PTFA211801E is a thermally-enhanced, 180-watt, internally matched LDMOS FET intended for WCDMA applications. It is characterized for single- and two-carrier WCDMA operation from 2110 to 2170 MHz. Manufactured with Infineon's advanced LDMOS process, this device provides excellent thermal performance and superior reliability.

PTFA211801E
Package H-36260-2

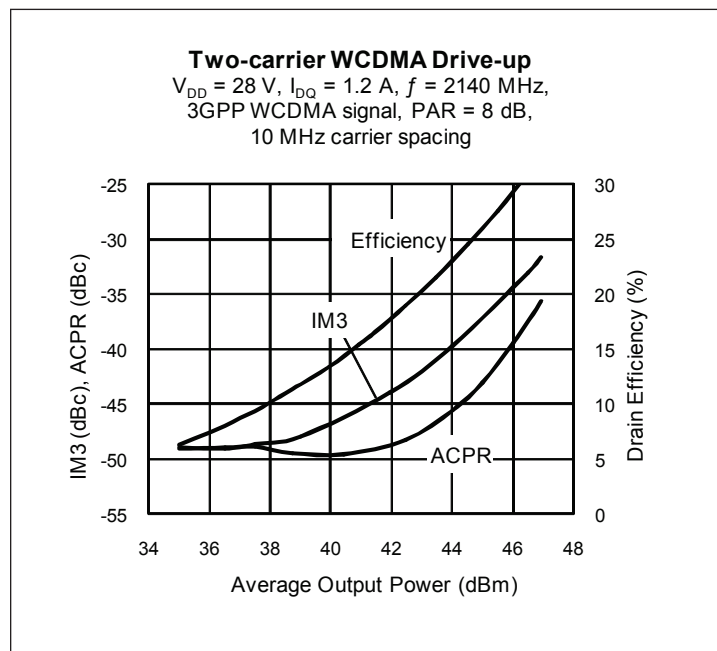

Features

- Broadband internal matching
- Typical two-carrier WCDMA performance at 2140 MHz, 28 V
 - Average output power = 45.5 dBm
 - Linear Gain = 15.5 dB
 - Efficiency = 27.5%
 - Intermodulation distortion = -36 dBc
 - Adjacent channel power = -41 dBc
- Typical CW performance, 2170 MHz, 30 V
 - Output power at P_{1dB} = 180 W
 - Efficiency = 52%
- Integrated ESD protection
- Excellent thermal stability, low HCI drift
- Capable of handling 10:1 VSWR @ 28 V, 150 W (CW) output power
- Pb-free and RoHS-compliant

RF Characteristics

WCDMA Measurements (tested in Infineon test fixture)

$V_{DD} = 28\text{ V}$, $I_{DQ} = 1.2\text{ A}$, $P_{OUT} = 35\text{ W}$ average, $f_1 = 2135\text{ MHz}$, $f_2 = 2145\text{ MHz}$, 3GPP signal, channel bandwidth = 3.84 MHz, peak/average = 8 dB @ 0.01% CCDF

Characteristic	Symbol	Min	Typ	Max	Unit
Gain	G_{ps}	14.5	15.5	—	dB
Drain Efficiency	η_D	26	27.5	—	%
Intermodulation Distortion	IMD	—	-36	-34	dBc

All published data at $T_{CASE} = 25^\circ\text{C}$ unless otherwise indicated

ESD: Electrostatic discharge sensitive device—observe handling precautions!

RF Characteristics (cont.)

CW Measurements (tested in Infineon test fixture)

 $V_{DD} = 28\text{ V}$, $I_{DQ} = 1.2\text{ A}$, $P_{OUT} = 150\text{ W}$ average, $f = 2170\text{ MHz}$

Characteristic	Symbol	Min	Typ	Max	Unit
Gain Compression	G_{comp}	—	0.5	1.0	dB

Two-tone Measurements (not subject to production test—verified by design/characterization in Infineon test fixture)

 $V_{DD} = 28\text{ V}$, $I_{DQ} = 1.2\text{ A}$, $P_{OUT} = 140\text{ W PEP}$, $f = 2140\text{ MHz}$, tone spacing = 1 MHz

Characteristic	Symbol	Min	Typ	Max	Unit
Gain	G_{ps}	—	15.5	—	dB
Drain Efficiency	η_D	—	38.5	—	%
Intermodulation Distortion	IMD	—	-28	—	dBc

DC Characteristics

Characteristic	Conditions	Symbol	Min	Typ	Max	Unit
Drain-Source Breakdown Voltage	$V_{GS} = 0\text{ V}$, $I_{DS} = 10\text{ mA}$	$V_{(BR)DSS}$	65	—	—	V
Drain Leakage Current	$V_{DS} = 28\text{ V}$, $V_{GS} = 0\text{ V}$	I_{DSS}	—	—	1.0	μA
Drain Leakage Current	$V_{DS} = 63\text{ V}$, $V_{GS} = 0\text{ V}$	I_{DSS}	—	—	10.0	μA
On-State Resistance	$V_{GS} = 10\text{ V}$, $V_{DS} = 0.1\text{ V}$	$R_{DS(on)}$	—	0.05	—	Ω
Operating Gate Voltage	$V_{DS} = 28\text{ V}$, $I_{DQ} = 1.2\text{ A}$	V_{GS}	2.0	2.5	3.0	V
Gate Leakage Current	$V_{GS} = 10\text{ V}$, $V_{DS} = 0\text{ V}$	I_{GSS}	—	—	1.0	μA

Maximum Ratings

Parameter	Symbol	Value	Unit
Drain-Source Voltage	V_{DSS}	65	V
Gate-Source Voltage	V_{GS}	-0.5 to +12	V
Junction Temperature	T_J	200	$^{\circ}\text{C}$
Storage Temperature Range	T_{STG}	-40 to +150	$^{\circ}\text{C}$
Thermal Resistance ($T_{CASE} = 70^{\circ}\text{C}$, 150 W CW)	$R_{\theta JC}$	0.31	$^{\circ}\text{C/W}$

Ordering Information

Type and Version	Package Outline	Package Description	Shipping
PTFA211801E V5	H-36260-2	Thermally-enhanced slotted flange, single-ended	Tray
PTFA211801E V5 R250	H-36260-2	Thermally-enhanced slotted flange, single-ended	Tape & Reel

Typical Performance (data taken in a production test fixture)

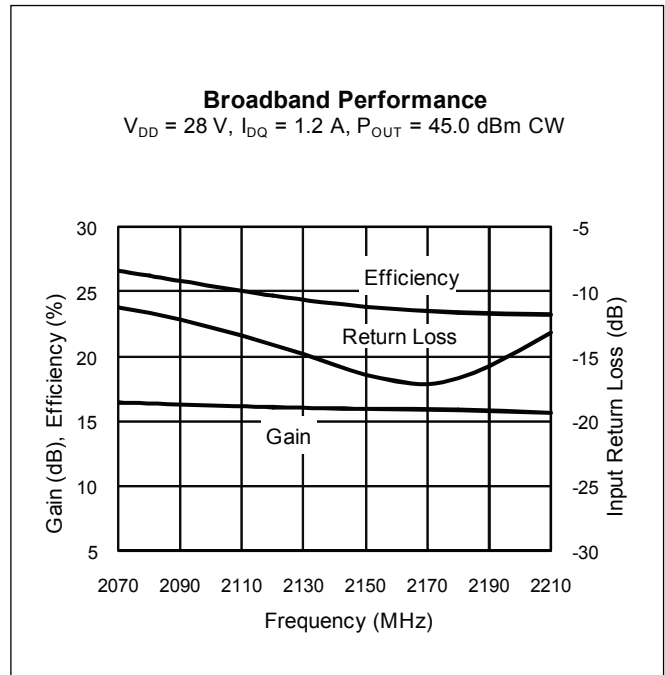
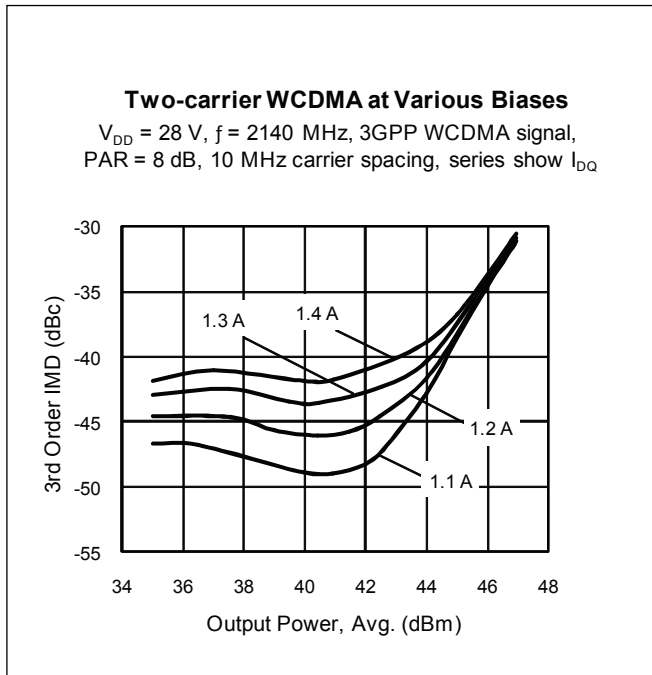

Typical Performance (cont.)

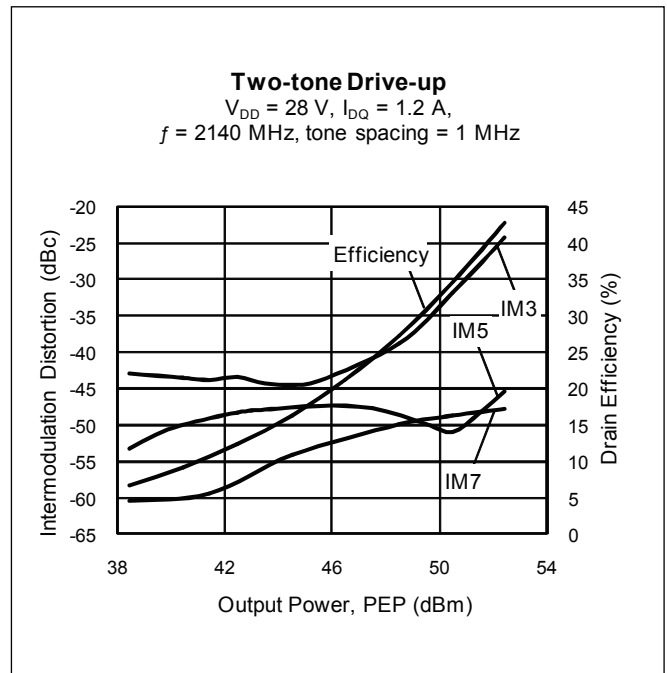
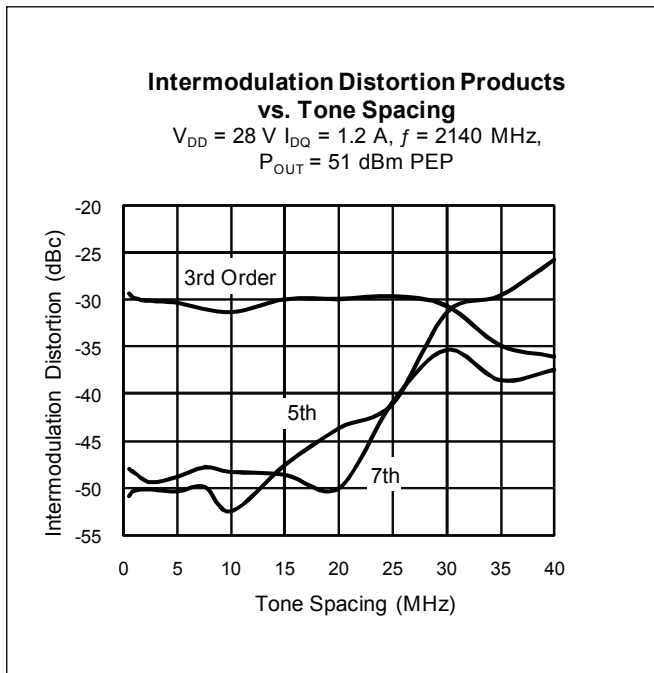
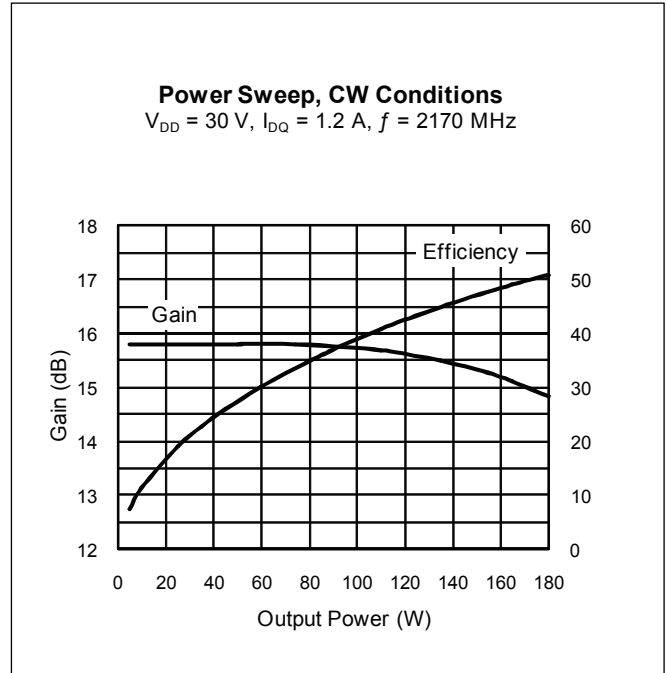
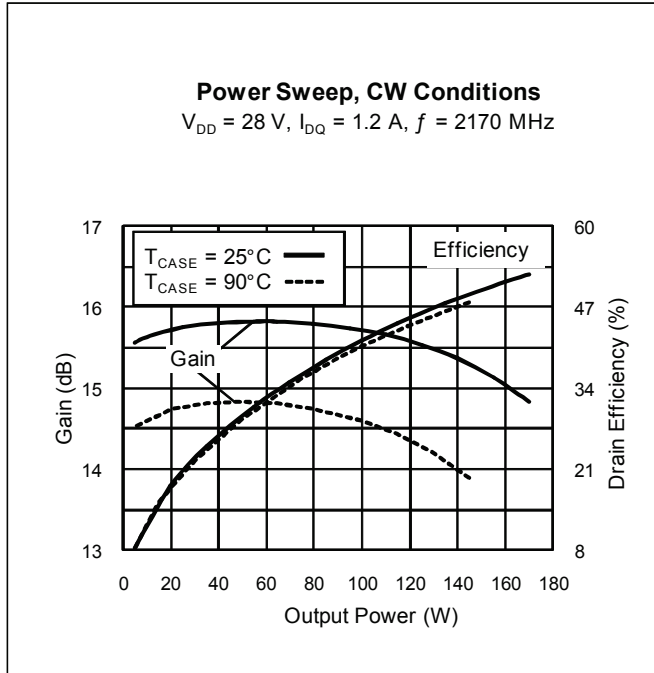

Typical Performance (cont.)

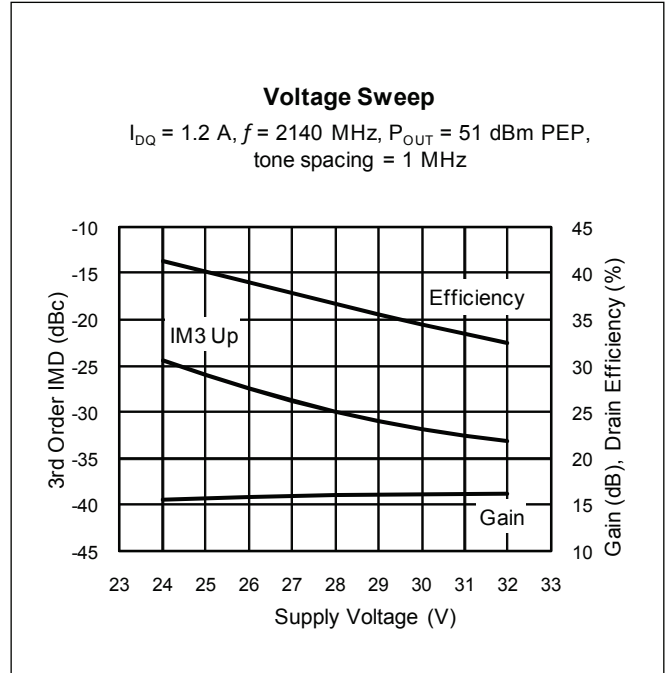
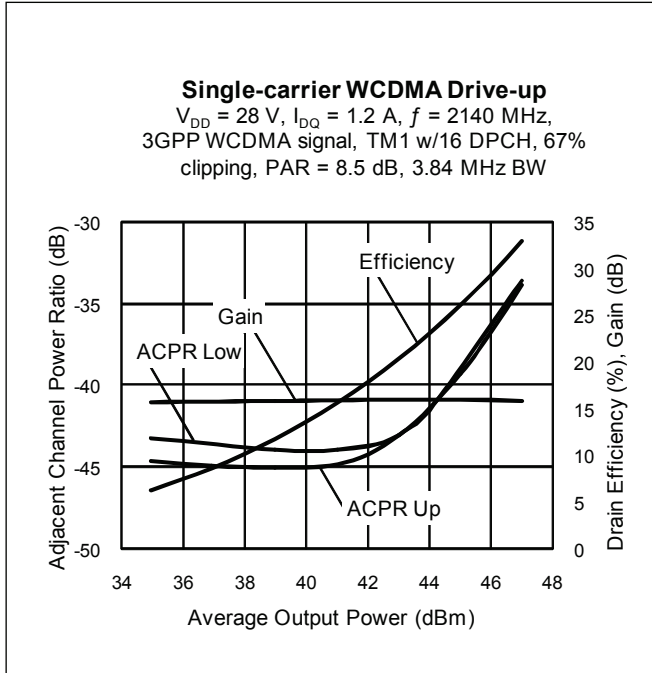

Broadband Circuit Impedance

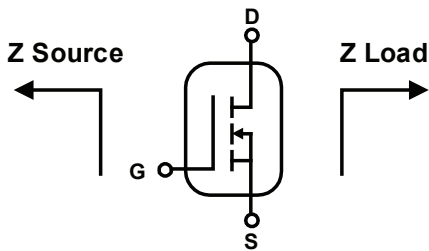

Frequency MHz	$Z_{Source} \Omega$		$Z_{Load} \Omega$	
	R	jX	R	jX
2070	7.2	-0.5	1.5	2.3
2110	7.8	-0.2	1.4	2.6
2140	8.4	-0.0	1.4	2.8
2170	9.1	0.0	1.4	3.0
2210	10.0	-0.2	1.3	3.4

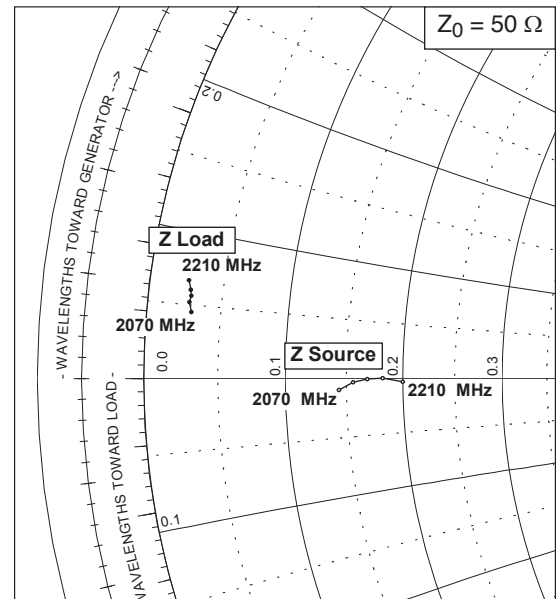

Reference Circuit

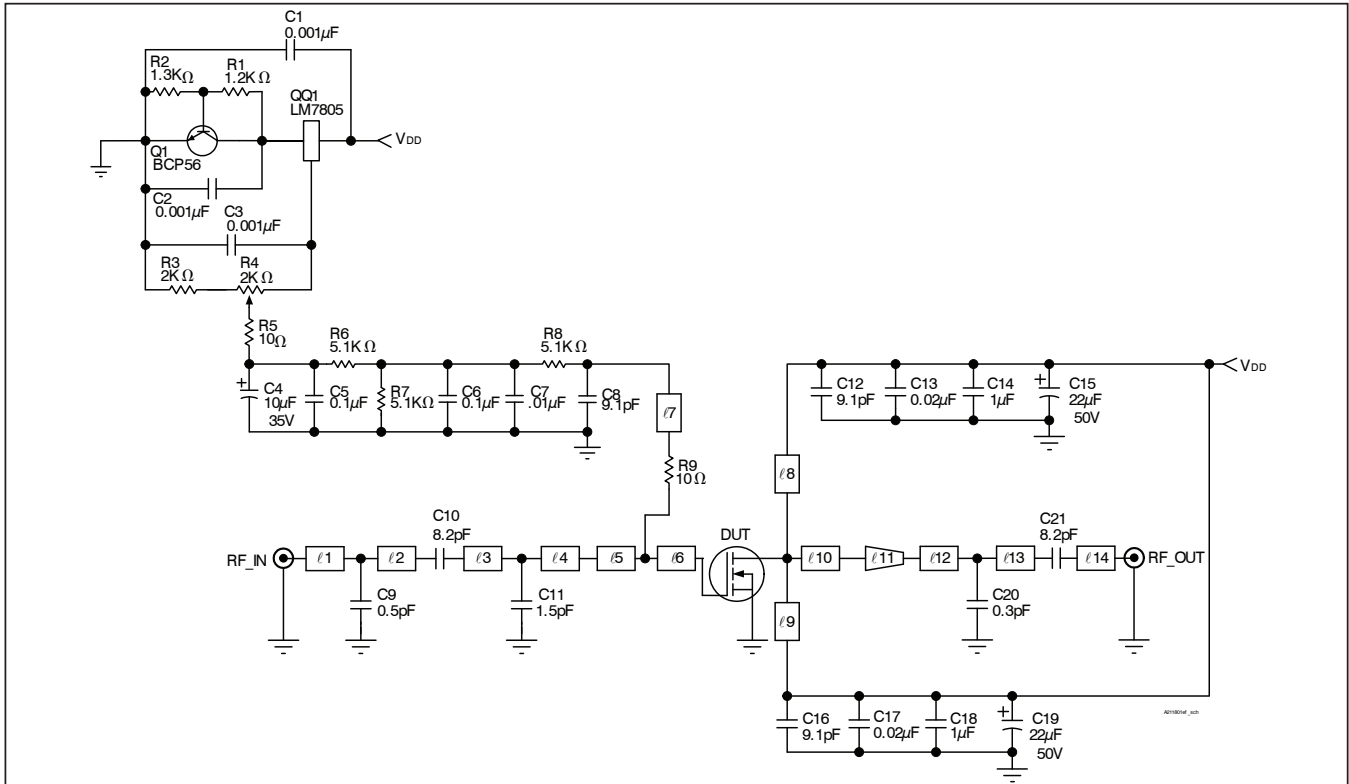

Reference circuit schematic for $f = 2140$ MHz

Electrical Characteristics at 2140 MHz

Transmission Line	Electrical Characteristics	Dimensions: L x W (mm)	Dimensions: L x W (in.)
l1	0.097 λ , 50.0 Ω	7.37 x 1.40	0.290 x 0.055
l2	0.267 λ , 50.0 Ω	19.86 x 1.40	0.782 x 0.055
l3	0.136 λ , 42.0 Ω	10.24 x 1.85	0.403 x 0.073
l4	0.087 λ , 42.0 Ω	6.50 x 1.85	0.256 x 0.073
l5	0.018 λ , 11.4 Ω	1.24 x 10.24	0.049 x 0.403
l6	0.077 λ , 6.9 Ω	5.23 x 17.78	0.206 x 0.700
l7	0.207 λ , 48.0 Ω	15.70 x 1.50	0.618 x 0.059
l8, l9	0.256 λ , 45.0 Ω	19.30 x 1.65	0.760 x 0.065
l10	0.087 λ , 5.0 Ω	5.84 x 25.40	0.230 x 1.000
l11 (taper)	0.073 λ , 5.0 Ω / 40.0 Ω	5.59 x 25.40 / 1.98	0.220 x 1.000 / 0.078
l12	0.019 λ , 40.0 Ω	1.45 x 1.98	0.057 x 0.078
l13	0.087 λ , 50.0 Ω	6.65 x 1.40	0.262 x 0.055
l14	0.403 λ , 50.0 Ω	30.73 x 1.40	1.210 x 0.055

Reference Circuit (cont.)

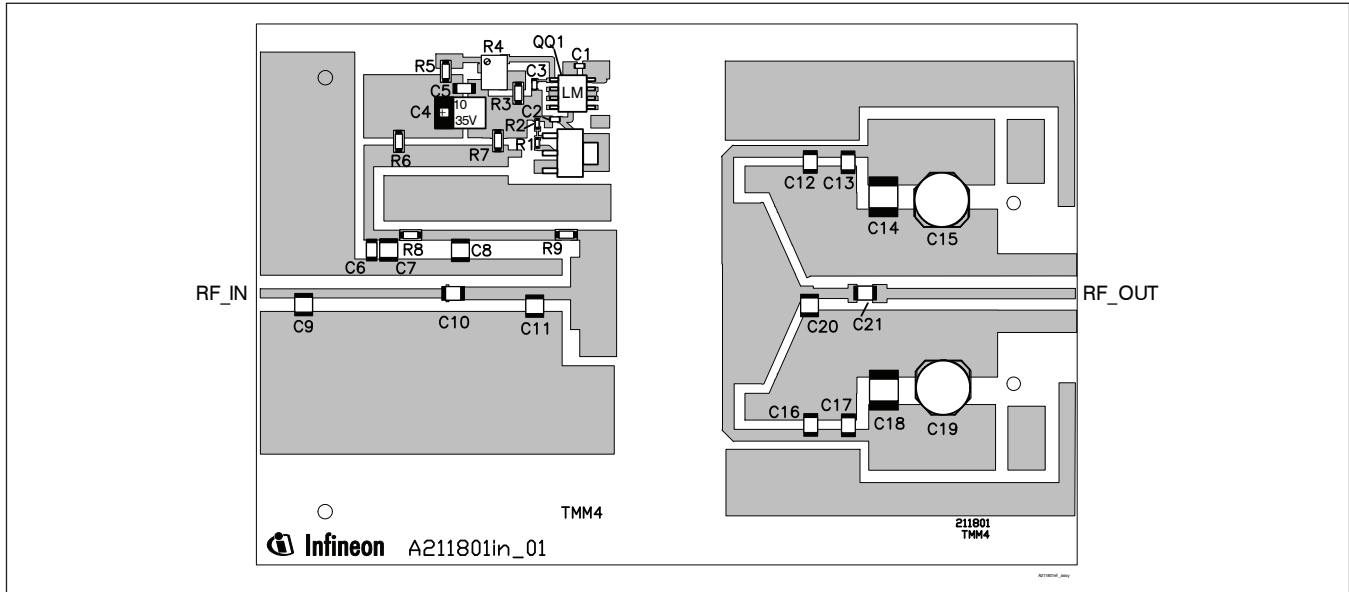

Reference circuit assembly diagram (not to scale)*

Circuit Assembly Information

DUT	PTFA211801E	LDMOS Transistor	
PCB	0.76 mm [.030"] thick, $\epsilon_r = 4.5$	Rogers TMM4	2 oz. copper

Component	Description	Suggested Manufacturer	P/N
C1, C2, C3	Capacitor, 0.001 μ F	Digi-Key	PCC1772CT-ND
C4	Tantalum capacitor, 10 μ F, 35 V	Digi-Key	PCS6106TR-ND
C5, C6	Capacitor, 0.1 μ F	Digi-Key	PCC104BCT
C7	Capacitor, 0.01 μ F	ATC	200B103
C8, C12, C16	Ceramic capacitor, 9.1 pF	ATC	100B 9R1
C9	Ceramic capacitor, 0.5 pF	ATC	100B 0R5
C10, C21	Ceramic capacitor, 8.2 pF	ATC	100B 8R2
C11	Ceramic capacitor, 1.5 pF	ATC	100B 1R5
C13, C17	Ceramic capacitor, 0.02 μ F	ATC	200B 203
C14, C18	Ceramic capacitor, 1 μ F	ATC	920C105
C15, C19	Electrolytic capacitor, 22 μ F, 50 V	Digi-Key	PCE3374CT-ND
C20	Ceramic capacitor, 0.3 pF	ATC	100B 0R3
Q1	Transistor	Infineon Technologies	BCP56
QQ1	Voltage regulator	National Semiconductor	LM7805
R1	Chip resistor, 1.2 k Ω	Digi-Key	P1.2KGCT-ND
R2	Chip resistor, 1.3 k Ω	Digi-Key	P1.3KGCT-ND
R3	Chip resistor, 2 k Ω	Digi-Key	P2KECT-ND
R4	Potentiometer, 2 k Ω	Digi-Key	3224W-202ETR-ND
R5, R9	Chip resistor, 10 Ω	Digi-Key	P10ECT-ND
R6, R7, R8	Chip resistor, 5.1 k Ω	Digi-Key	P5.1KECT-ND

* Gerber Files for this circuit available on request

Package Outline Specifications

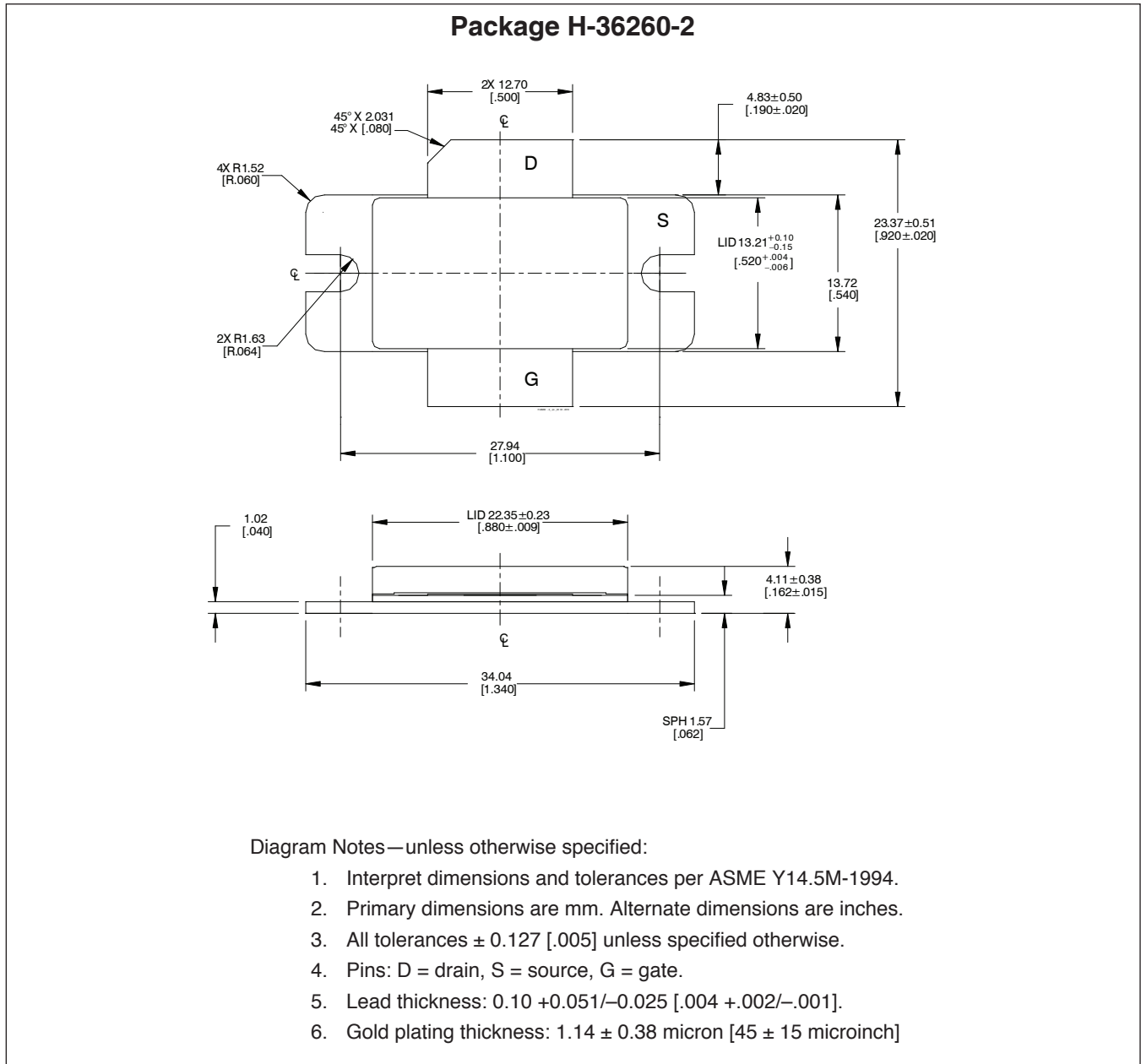

Find the latest and most complete information about products and packaging at the Infineon Internet page <http://www.infineon.com/rfpower>

Revision History: 2011-01-11 Data Sheet

Previous Version: 2010-08-04, Data Sheet

Page	Subjects (major changes since last revision)
1	Updated ESD protection feature
All	Removed earless package

We Listen to Your Comments

Any information within this document that you feel is wrong, unclear or missing at all?
 Your feedback will help us to continuously improve the quality of this document.
 Please send your proposal (including a reference to this document) to:

highpowerRF@infineon.com

To request other information, contact us at:
 +1 877 465 3667 (1-877-GO-LDMOS) USA
 or +1 408 776 0600 International

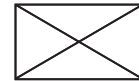

Edition 2011-01-11

Published by
 Infineon Technologies AG
 81726 Munich, Germany

© 2005 Infineon Technologies AG
 All Rights Reserved.

Legal Disclaimer

The information given in this document shall in no event be regarded as a guarantee of conditions or characteristics. With respect to any examples or hints given herein, any typical values stated herein and/or any information regarding the application of the device, Infineon Technologies hereby disclaims any and all warranties and liabilities of any kind, including without limitation, warranties of non-infringement of intellectual property rights of any third party.

Information

For further information on technology, delivery terms and conditions and prices, please contact the nearest Infineon Technologies Office (www.infineon.com/rfpower).

Warnings

Due to technical requirements, components may contain dangerous substances. For information on the types in question, please contact the nearest Infineon Technologies Office.

Infineon Technologies components may be used in life-support devices or systems only with the express written approval of Infineon Technologies, if a failure of such components can reasonably be expected to cause the failure of that life-support device or system or to affect the safety or effectiveness of that device or system. Life support devices or systems are intended to be implanted in the human body or to support and/or maintain and sustain and/or protect human life. If they fail, it is reasonable to assume that the health of the user or other persons may be endangered.