



2018-2019

**INDUSTRIAL
NETWORKING
PRODUCTS**

Engineered and
manufactured
in Taiwan

Contents



Industrial Networking

Introduction	04
Brand ATOP and certainty	05
Reliability	05
Harsh Environments	07
Electromagnetic Compatibility	07
Network Security & Encryption	08
Performance & Responsiveness	09

Industry Specific Ethernet Switches

Power Networking: IEC 61850-3	24
IEC61850-3 DIN-Rail Managed Switches	25
IEC61850-3 Rackmount, HSR/PRP, PTP BC	26
EN 50155 – Railway Networking	28
EN 50155 – Railway Unmanaged Switches	30
EN 50155 – Railway Managed Switches	31

Entry level Switches

Unmanaged Entry-Level Switches	11
Unmanaged Smart Secure Switches	12
Unmanaged Gigabit PoE Switches	13

Industrial Wi-Fi & Media Converters

Industrial Wireless	32
Industrial Wi-Fi Mesh	33
Media Converters	34

Harsh Environment Networking

Harsh Environment Networking	14
24V Compact PoE Injectors	15
Unmanaged Harsh-Environment Switches	15
24V PoE Booster Unmanaged Switches	16
24V PoE Booster Lite-Managed Switches	16
Layer-2 Managed DIN-Rail Switches	17
Layer-3 Managed Switches	19
Rack-mount Managed Switches	21
Modular Concept	22
Switch Core Platforms	22
Modules	23

Serial Device Servers

Serial Device Servers	35
Entry Level Serial Device Servers	35
Wireless / Cellular Serial Device Servers	36
Advanced Serial Device Servers	37
IEC61850-3 – Serial Device Servers	39
EN 50155 – Railway Specific Serial Servers	39



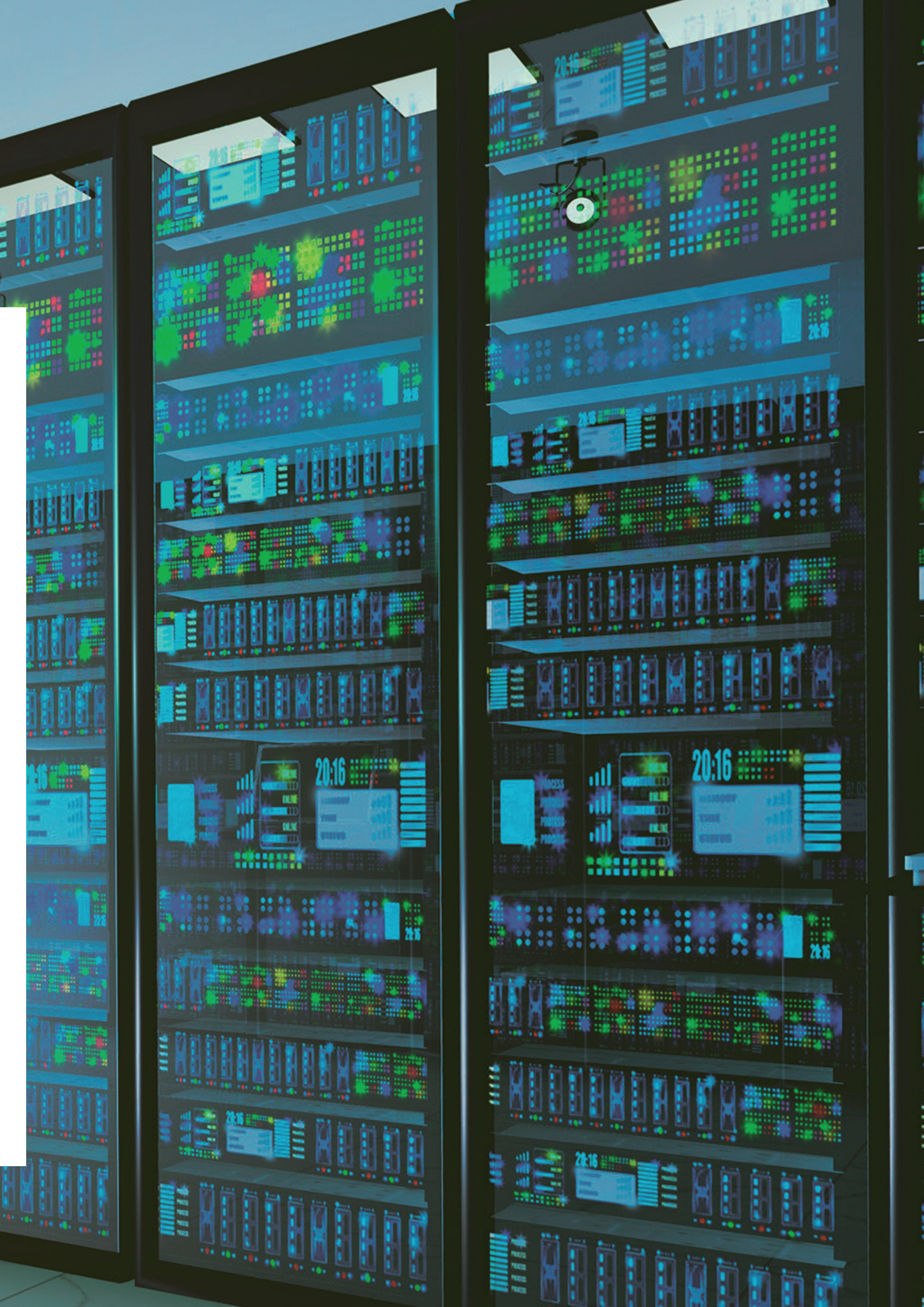

Industrial Networking



Introduction

Championed as the Fourth Industrial Revolution, Industry 4.0 has emerged as an imperative to put industries at the forefront of new opportunities. With the dawn of Smart Factory, a new intelligent and connected manufacturing has become the new flavour of this era. Are you enabling smart automation connectivity on the factory floor to enhance productivity, reduce expense, minimize system downtime and improve process matrix... even under the harshest and most challenging work conditions?

At the juncture of this critical transformational industrial shift - are you ready to respond to individual demand by enabling connected manufacturing? Are you equipped to converge advanced robotics, big data Analytics with industrial connectivity to enable faster, more flexible, and more efficient processes to produce and enable higher-quality goods and services at reduced costs?

At ATOP, we solve our clients' toughest industrial networking and computing problems through our slew of industry ready and customized product lines. With expertise across sectors like Industrial Automation, Power Substations, Smart Grid, Railways, Industrial Networking, IT Services, Oil and Gas, we deliver transformational outcomes for a demanding new industrial manufacturing world.

With close to three decades of experience, ATOP has built a name of repute in developing and manufacturing a range of new age industrial networking and computing products to suit your application mandate... within your budget. Our wide array of product categories encompasses industrial Ethernet switches, Serial Device Servers, Industrial Wireless, Industrial Ethernet and Fieldbus Gateways, Media Converters, Industrial Computing, Precision Timing Clocks, Industrial NTP servers, Power Supplies, Transceivers etc.





Brand ATOP and certainty

With close to three decades of delivering extraordinary outcomes, today Atop is synonymous with its commitment to global delivery manufacturing flexibility, precise execution, innovations concerning product-process technologies, agile adaptation to demanding customer challenges and its close collaboration with stakeholders.

Reliability

Much of what underpins network reliability remains to be the most important priority for factory control and automation systems. Considering that a factory network infrastructure absorbs wide range of networking devices, network reliability hinges on network architecture, operational plans and uncompromised connectivity. Only a successful unification can ensure an unfailing operation in harsh industrial environments.

ATOP's range of hardware is built to minimize downtime events. Built-in redundancy features such as High-Availability Seamless Redundancy (**HSR**), Parallel Redundancy Protocol (**PRP**) Ethernet Ring Protection Switching (ITU-T G.8032 **ERPS**), Spanning Tree, Rapid Spanning Tree and Multiple Spanning Tree Protocol (**STP**, **RSTP**, **MSTP**) and Media Redundancy Protocol (**MRP**) ensure ideal upkeep times.

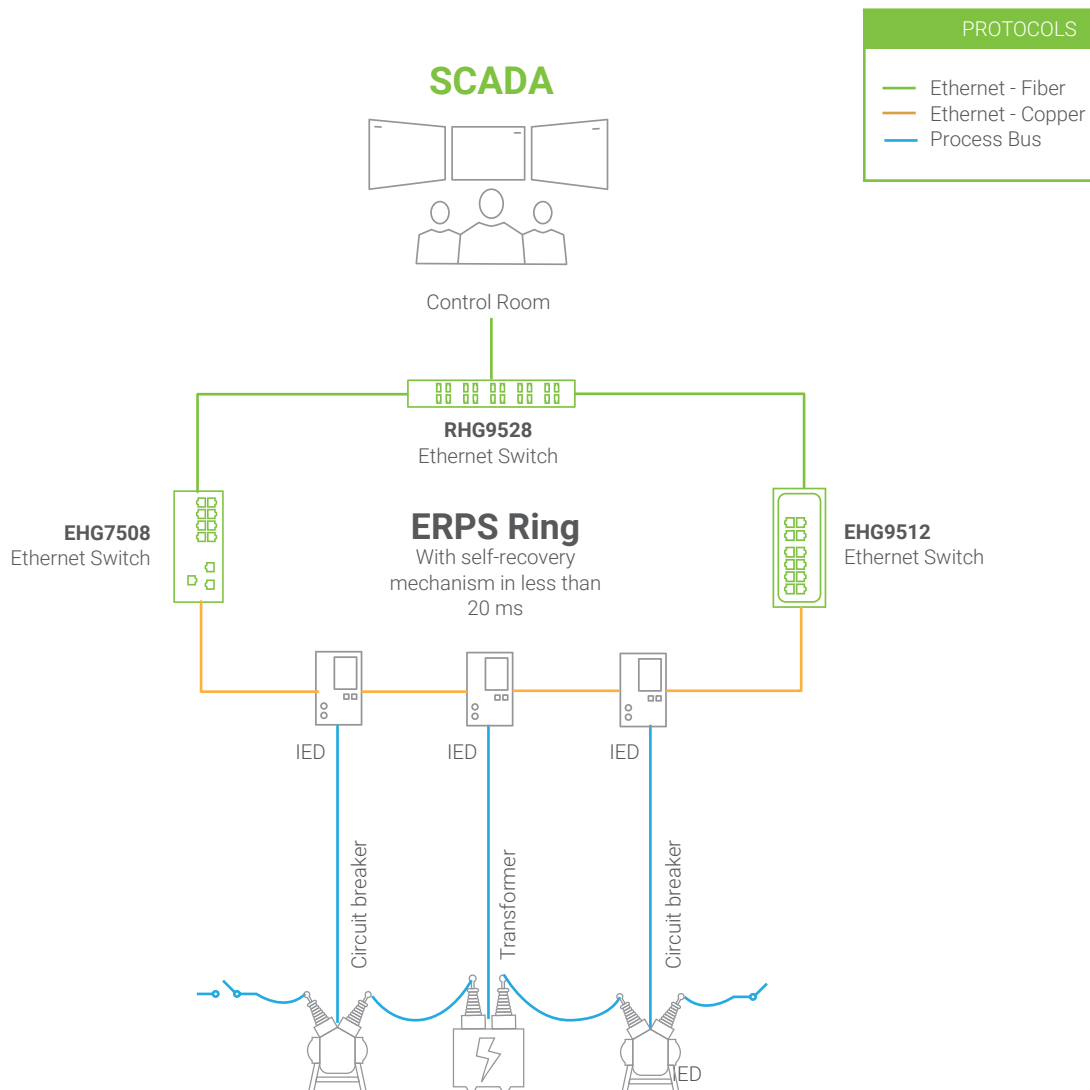

FEATURED PRODUCTS



EHG7508 : Industrial 8-Port PoE Managed Gigabit Switch (-20~70 °C)

- 8 10/100/1000 RJ45 ports or 1000 SFP slots
- maximum 8 x 30 W PoE ports (240W power budget)
- Profinet CC-B compatible; Ethernet/IP; ERPS, RSTP, STP, MRP Client redundancy;
- IEEE 1588v2 Hardware-assisted TC and many others



EHG9512 : IEC 61850-3 12-Port Managed Gigabit Switch (-40~85 °C)

- 8 x 10/100/1000 RJ45 ports and 4 Gigabit SFP uplink slots
- IEC 61850-3, IEEE 1613 certified
- UL/cUL/IEC(CB) 61010-2-201 certified
- IEEE 1588v2 Hardware-assisted TC; ERPS, RSTP, STP, MRP Client redundancy;



RHG9528 : IEC 61850-3 modular Managed Switch, max 24 Gigabit and 4 x 10 GbE ports (-40~85 °C)

- 3 x 8-port Gigabit module slots and 4x 1 or 10 Gigabit SFP uplink slots
- Available modules: 8 x 10/100/1000 RJ45 or 8 x 100/1000 SFP
- IEC 61850-3, IEEE 1613, UL/cUL/IEC(CB) 61010-2-201 certified
- IEEE 1588v2 Hardware-assisted TC; ERPS, RSTP, STP, MRP Client redundancy;



Harsh Environments

From blast furnaces to operating in sub zero-degree environments, ATOP's line of hardware is designed to withstand the rigors of harsh operational conditions. With an ability to endure **operations temperature that ranges between -40°C to +85°C**, our hardware uses high quality industrial grade materials to guarantee a long Mean Time Between Failures (MTBF).

Thanks to **fanless design**, our devices reduce the number of moving parts, save space, reduce breakdowns and failures, thereby prolonging the operational lifetime of your investment.

Electromagnetic Interference and Susceptibility

High-voltages and electromagnetic interferences in factories can be fatal and quickly compromise system reliability if installed devices are not properly shielded and isolated from electromagnetic discharges.

Without proper precautions, equipment failures occur – for instance, a 2,000-Volt surge applied to a power supply unit can cause severe system damage. **Devices should be designed to ensure no interference with surrounding equipment**, as their own radiated emissions can generate noise and interference. Severe **electromagnetic interference can cause high temperature variations, server, network switch disablement, data communication interruption and in the worst cases even breakdowns.**

ATOP's hardware, engineered to offer a higher level of protection, conforms with high Electromagnetic Susceptibility (EMS) and Electromagnetic Interference (EMI) standards. And these are in addition to conforming with Level 3 and Level 4 Electromagnetic Compatibility (EMC), which makes ATOP's hardware compliant with the strictest regulations for susceptibility and interference – such as UL61010-2-201, UL60950, UL62368 and EN61000-6-2 and EN61000-6-4 with selected hardware specifically designed for even harscher applications such as IEC61850-3 and EN50155.



Network Security and Data Encryption

With explosive growth of devices and data, within the context of digital transformation, converging networks bring with them lethal security challenges that can have extensive effects across Industry 4.0 driven operations. As increased digital proliferation pose more risks, more points of entry lay susceptible to various sophisticated threats and malicious activities.

To adequately address this, ATOP has launched secure, vigilant and resilient hardware solutions for seamless and cost-effective security and encryption: **MACsec** for security over LANs; and software-based **IPsec, OpenVPN and PPTP** for security over WANs and the Internet.

Armed with authentication, integrity and data confidentiality, MACsec (or IEEE 802.1AE protocol) enhances your network with hop-to-hop **AES 128-bit strong encryption** and defines how public-private keys are managed. While the communication encrypted from hop-to-hop (decrypted on receipt and encrypted again, with a different secure key before forwarding), **it protects your network from wiretapping, masquerading, man-in-the-middle attacks, denial-of-service, impersonation and replay attacks**. What's more, being the encryption carried out by hardware, almost the full Gigabit Bandwidth is preserved, very little or no additional latency is added to the network.

ATOP is a pioneer in the security of network devices. In our continuous endeavour to bring the very best we have introduced a whole new range of products. This includes, Managed L2 and L3 switches (for advanced networks that demand routing between different VLANs and IP based routing). Our cost-effective smart and secure switches offer PoE connectivity and superior performance in harsh environments. With the 128-bit encryption managed through hardware, we provide a seamless experience and unprecedented performance.

ATOP's VPN Gateways provide embedded security measures, through VPNs using IPsec encryption, so that all data going in and out of devices can be properly protected from potential attacks.

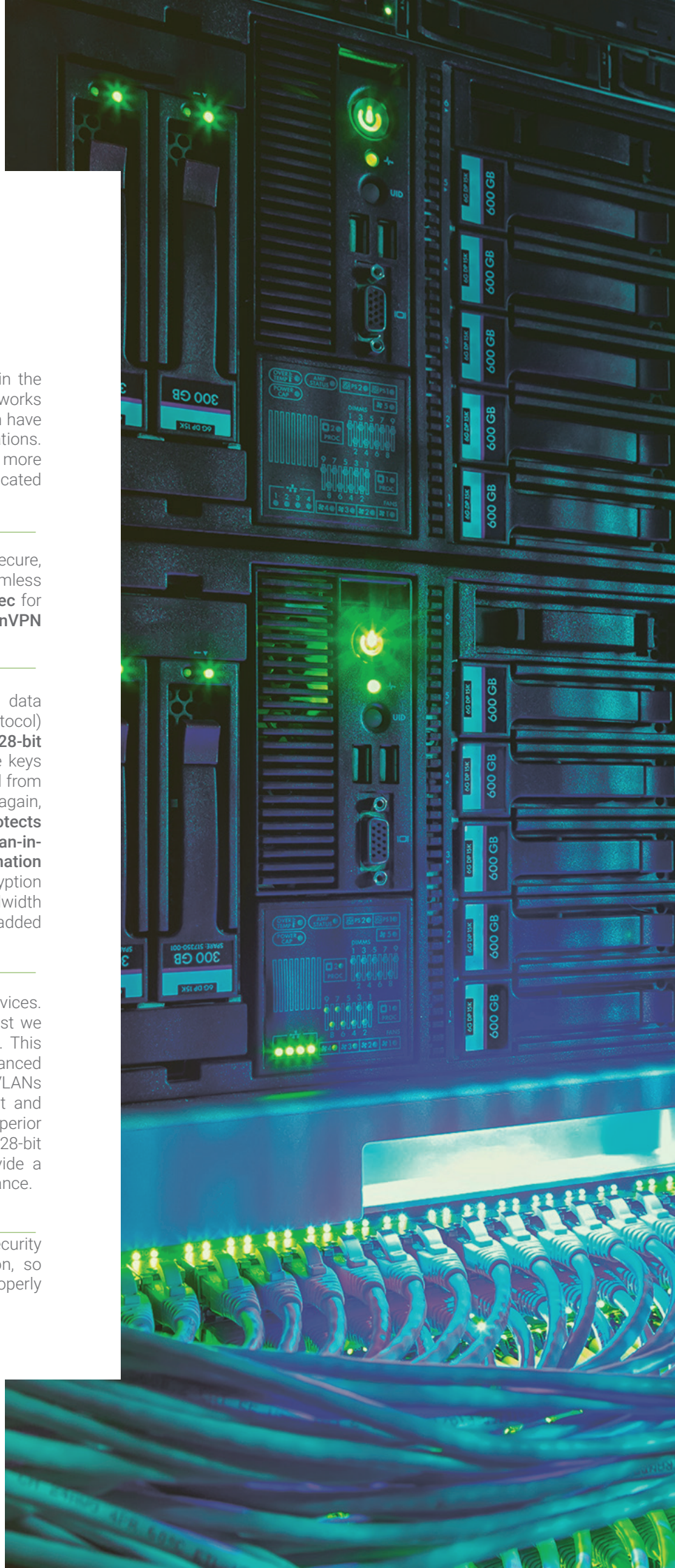

Performance and Responsiveness

Integrating new and emerging network hardware with legacy network equipment can often be difficult but indispensable to the churn of tomorrow's smart manufacturing. New technologies not only offer much wider bandwidths but also demand stricter performance requirements. The integration may result in slow process acceleration while exploring and consolidating performance discrepancies, such as differences in speed or data throughput.

ATOP being a 30-year-old company is in synch with the leaps of innovation and retrofitting new into legacy to enable several specific smart capabilities and outcomes. For example, our new network devices can autonomously poll data from legacy network devices and store them in an internal memory. A master device running on a newer protocol or higher physical layer can then request the updates at a later point. This helps to reduce bottlenecks and enhance system performance.

An illustration of our Application

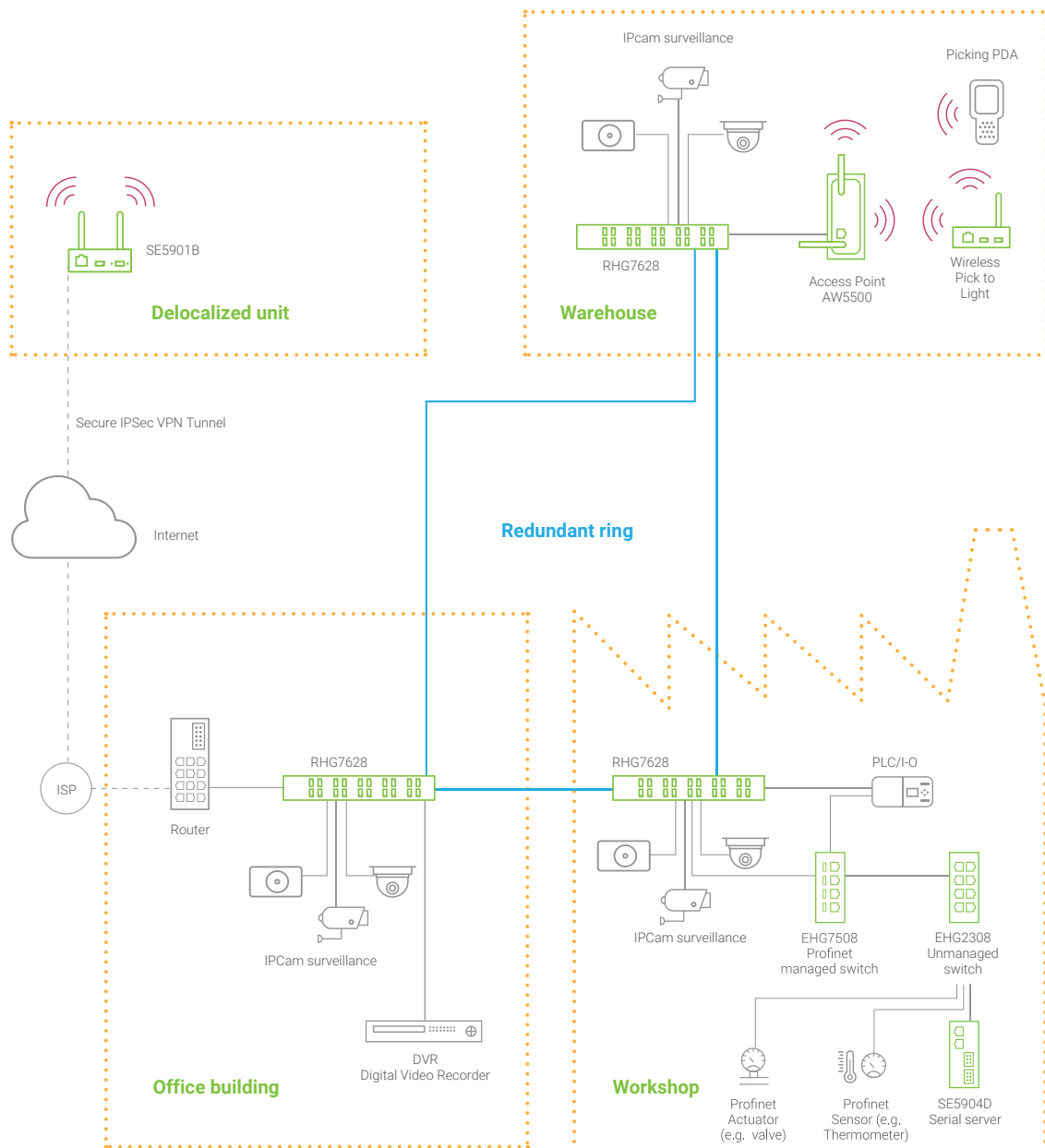

PROTOCOLS	
	Copper or Fiber Ethernet
	Wireless
	10 Gigabit Ethernet Fiber backbone

More information on our Application Illustration

RHG7628 - Layer-3 Modular Gigabit Managed PoE Rack-Mount Switch

- Modular architecture for up to 24 Gigabit ports and 4x1 or 4x10 Gigabit Ethernet uplink SFP slots.
- Flexible configuration allows PoE, RJ45, SFP, secure RJ45-SFP ports to be embedded in one device.
- Up to 24 PoE/PoE+ 802.3af-802.3at ports, with maximum 720 W power budget
- -40~75 °C Operating temperature. CE/FCC certified and UL/cULus listed.
- Profinet Conformance Class B v2.33 certified
- Redundancy through ERPS/RSTP/STP/MSTP/MRP (client) protocols
- IEEE 1588v2 hardware-based End-to-End transparent clock



EHG7508 - DIN-Rail 8-Port Managed Gigabit Ethernet PoE switch

- 8 Gigabit ports, in different RJ45/PoE/SFP configurations.
- Up to 8 802.3af 802.3at PoE/PoE+ ports allowing 240 W maximum PoE power Budget
- -20~70 °C Operating temperature. CE/FCC certified and UL/cULus listed
- Profinet Conformance Class B v2.33 certified
- Redundancy through ERPS/RSTP/STP/MSTP and MRP (client).
- Redundant power supply and relay output.



EHG2308 - DIN-Rail 8-Port Unmanaged Gigabit Ethernet switch

- 8-Gigabit RJ45 ports
- -10~70 °C Operating temperature
- Profinet packet prioritization according to 802.1p
- UL/cULus listed
- Redundant power input



SE5901B - DIN-Rail 3G/4G LTE Industrial Serial Device Server

- One Gigabit RJ45 port
- One sw-selectable RS-485/232 serial port
- Battery Feature [opt] provides up to 30s additional power for alarm relay in case of power failure
- 2 Digital inputs / 2 Relays [optional]
- -40~75 °C Operating temperature



AW5500 - DIN-Rail IEEE 802.11 a/b/g/n high-performance Access Point

- IEEE 802.11 abgn radio, supporting 2 x 2 MIMO, 2.4 and 5.0 GHz
- One 10/100/1000 RJ45 Ethernet port
- -10~60 °C Operating temperature
- Different operating mode and Topology Options (WDS Bridge and AP Client)

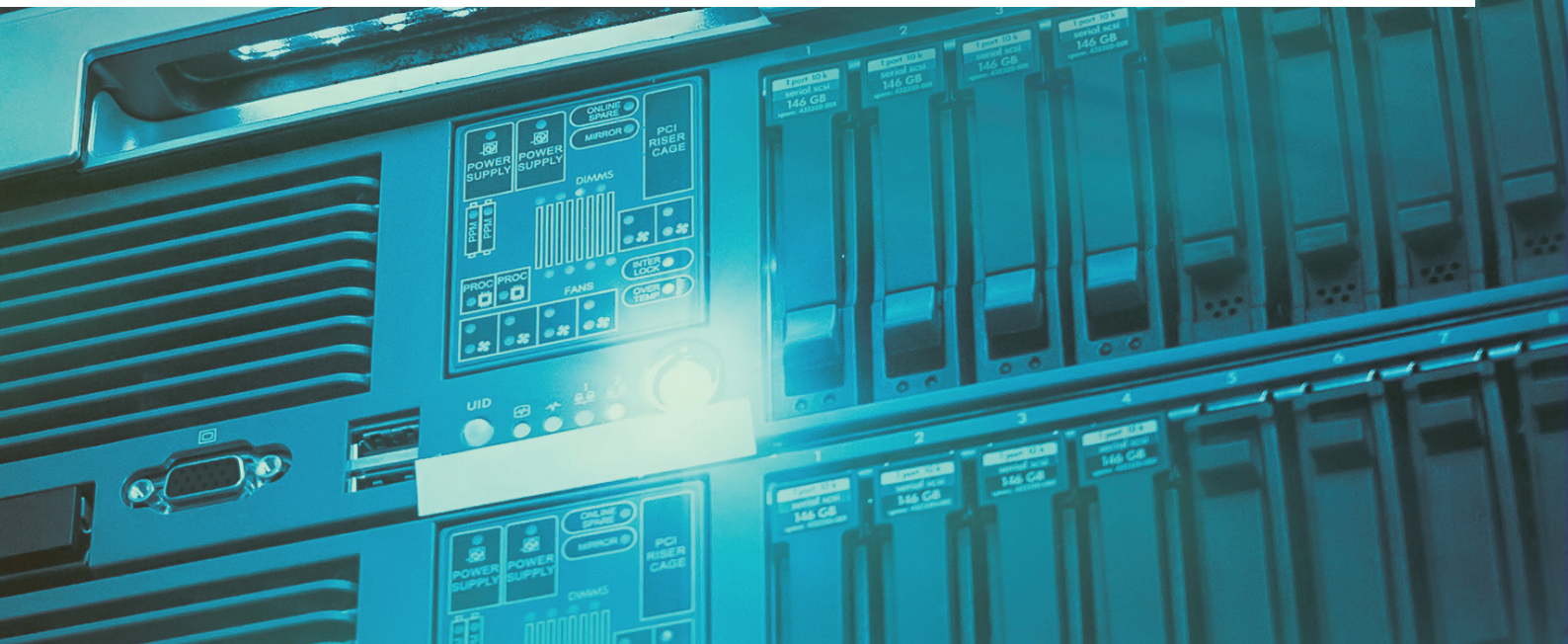

Entry Level Switches

Unmanaged Entry-Level Switches

ATOP's Entry Level Unmanaged Switches offer a reliable, robust, and cost-effective solution for simple network topologies.



With IP30 protection rating, all unmanaged entry-level switches are Industrial EMC-certified: EN61000-6-4 and EN61000-6-2. Utilising either aluminum, steel, or plastic housing, they are rugged enough to suit different application environments and budgets. All models support redundant DC power-input, and DIN-Rail mounting. They can operate in temperatures ranging from -10°C to 70°C (units with plastic housing can operate within a range of 0°C to 60°C). For enhanced safety and backup, redundant power input is available on every model. Our devices comply with FCC, UL, CE, RoHSII and REACH standards.

Our products feature 4 to 16 Fast Ethernet or Gigabit Ethernet ports. Selected versions have single-mode or multi-mode Fiber optic uplink, and selected versions feature Power over Ethernet (PoE) and Gigabit speeds. And as unmanaged switches, they require no configuration efforts. Selected products support Packet Prioritization for Profinet according to 802.1p.





Unmanaged Fast-Ethernet Switches, DIN-Rail mount, Plastic Housing



SKU	Description	10/100 RJ45 ports	Gigabit RJ45 ports	Fiber ports	Max PoE Ports	Additional features
 	EH2005-Fm	5-Port Unmanaged Switch with Fiber Optics, plastic	4	-	1 multi-mode max 2 Km	-
	EH2005-Fs	5-Port Unmanaged Switch with Fiber Optics, plastic	4	-	1 Single-mode max 20 Km	-
	EH2006	6-Port Unmanaged Switch, Plastic housing	6	-	-	-
	EH2008	8-Port Unmanaged Switch, Plastic housing	8	-	-	-

Unmanaged Fast-Ethernet Switches, DIN-Rail mount, Metal Housing



SKU	Description	10/100 RJ45 ports	Gigabit RJ45 ports	Fiber ports	Max PoE Ports	Remarks	
	EH2305-1Fm	5-Port Unmanaged Switch with Fiber Optics, Metal Housing	4	-	1 (Multi-Mode) – max 2 Km	-	
	EH2305-1Fm	5-Port Unmanaged Switch with Fiber Optics, Metal Housing	4	-	1 (single-mode) – max 20 Km	-	
	EH2306	6-Port Unmanaged Switch, Metal housing	6	-	-	-	
 	EH2308	8-Port Unmanaged Switch, Metal housing	8	-	-	Profinet CC-A	
	EH2304-PR	4-Port Unmanaged switch, Metal slim housing	4	-	-	-	Profinet CC-A, Profinet connectors
	EH2308-PR	8-Port Unmanaged switch, Metal housing	8	-	-	-	Profinet CC-A, Profinet connectors
	EH2316-2G	16-Port Unmanaged Fast Ethernet switch with 2 Gigabit Uplinks	16	2	-	-	Oper. Temperature: -10~60C

Unmanaged Gigabit Ethernet Switches, DIN-Rail mount

NEW



SKU	Description	10/100 RJ45 ports	10/100 /1000 ports	Fiber ports	Max PoE Ports	Remarks
	EHG2008	-	8	-	-	Profinet packet prioritization. Max Temp: 0~60C
	EHG2308	-	8	-	-	Profinet packet prioritization according to 802.1p

Unmanaged Smart Secure Switches

ATOP's Unmanaged Smart Secure Switch is the most cost-effective, seamlessly encrypted, low latency solution for bringing security to your network without having to worry about any configuration.

Its embedded CPU will handle a hassle-free key-negotiation with hosts automatically from a properly set Pre-Shared Key, so that users do not have to access the switch personally to key-in any configurable parameters to get going. ATOP's Gigabit Unmanaged Smart and Secure Switch is embedded with 6 x 10/100/1000 RJ45 ports and 2 x 10/100/1000 Secured RJ45 or SFP ports with MACsec encryption support Embedded MACsec Key Agreement offers high-protection with no configuration.

Unmanaged Gigabit Ethernet Secure Switches, DIN-Rail mount, Metal Housing

NEW



SKU	Description	10/100 RJ45 ports	100 SFP slots	10/100 /1000 ports	1000 SFP slots	Max PoE Ports	Additional features
	EHG2408	-	-	8 *	-	-	Prioritizes Profinet packets
	EHG2408-2SFP	-	-	6	2	-	Prioritizes Profinet packets

* The 2 uplink ports out of the 8 ports available is MACsec capable

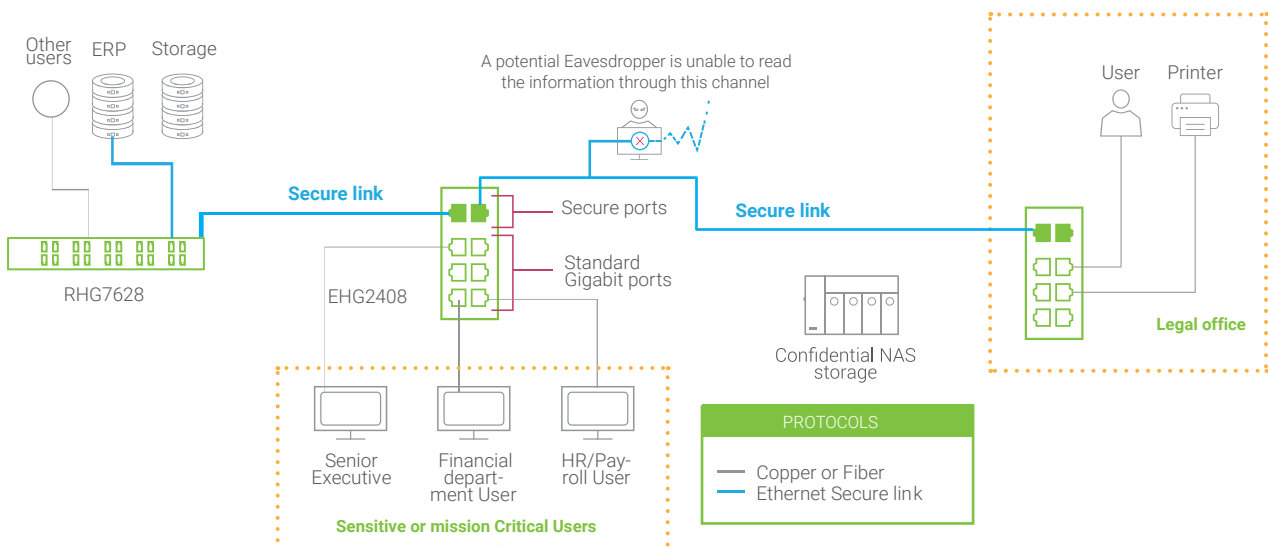

Unmanaged Gigabit PoE Switches

ATOP's Entry Level DIN-Rail mount unmanaged switch is enhanced with Power-over-Ethernet (PoE) and Gigabit SFP technologies, making them ideal for simple industrial applications. Both **PoE (802.3af) and PoE+ (802.3at) standards are supported**. While each device provides up to 30W power budget per port, the EHG6308-4PoE also provides the relay warning function during power failures. And along with an embedded redundant DC power input, each device can operate in temperatures between -10°C to 70°C.

Unmanaged Gigabit Switches with PoE, DIN-Rail mount, Metal Housing



SKU	Description	10/100 RJ45 ports	100 SFP slots	10/100 /1000 RJ45 ports	1000 SFP slots	Max PoE Ports	Additional features
 EHG6308-4PoE	8-Port Unmanaged Gigabit Switch with 4 PoE Ports, Metal Housing	-	-	8	-	4	
EHG6308-4PoE-4SFP	8-Port Unmanaged Gigabit Switch with 4 PoE Ports and 4 SFP Uplinks	-	-	4	4	4	

...more information on our Application Example

RHG7628 - Layer-3 Modular Gigabit Managed PoE Rack-Mount Switch



- Modular architecture for up to 24 Gigabit ports and 4x1 or 4x10 Gigabit Ethernet uplink SFP slots.
- Flexible configuration allows PoE, RJ45, SFP, secure RJ45-SFP ports to be embedded in one device.
- Up to 24 PoE 802.3af-802.3at ports, with maximum 720 W power budget
- -40~75 °C operational temperature. CE/FCC certified and UL/cULus listed.
- Profinet Conformance Class B v2.33 certified
- Redundancy through ERPS/ RSTP/MRP (client) protocols
- IEEE 1588v2 hardware-based End-to-End transparent clock

EHG2408 - DIN-Rail 8-Port Smart Secure Unmanaged Gigabit switch



- 6-Gigabit non-Secure RJ45 ports
- 2-Gigabit Secure MACsec RJ45 ports or SFP slots
- Simple, high performing strong security
- -20~70 °C operational temperature
- prioritization according to 802.1p
- CE/FCC certified, UL/cULus listed
- Redundant power input

Harsh Environment Networking

ATOP's extensive, advanced product line offers hundreds of possible configurations and options. Resilient, high-density, highly secure, our harsh environment line is the best choice to support demanding networks –for difficult and challenging mission critical environments.

Ranging from PoE Injectors to Layer-3 Switches, ATOP Industrial Networking features up to 28 Fast Ethernet, Gigabit or 10 Gigabit ports, an operating temperature range from -20°C to 70°C or wider, PoE/PoE+ ports equipped with Relay Output, Redundant power input, Packet Prioritization according to 802.1p (for Unmanaged Switches), and Profinet CC-B v2.33 certification (for Managed Switches).

All are MIL-STD shock and vibration certified, with performance in high humidity and can operated in temperature ranges up to -40°C to +75°C.

ATOP's Harsh-Environment Unmanaged Switches provide high EMC protection, ruggedness for the most demanding applications and easy plug-and-play installation. Our Unmanaged switches have a wide-range operation temperature. Selected versions, both PoE and non-PoE versions are Railway certified and Atex and UL Cl. 1 Div. 2 certified for Oil and Gas applications.

Also, do more with your PoE with ATOP. EHG6400 Family supports PoE voltage booster, providing up to 60W of PoE power with just 12V input on up to 8 Gigabit ports, or up to 120 Watts of power with 24VDC input and over.

ATOP's Lite-Managed Gigabit Switches provide added redundancy, exceptional performance, manageability and reliability, maximizing value for money. EHG6500 Family enables an 8 or 10-port Gigabit switch to act smartly with visibility and control, prioritizing traffic, managing VLANs, policies and providing smart redundancy in mission-critical applications while keeping costs under control.

ATOP's range of ruggedized Managed Switches provide advanced network management to maximize network performance and minimize downtimes. Our Managed Switches use ERPS, RSTP, STP, MSTP and MRP (Client) to minimize such downtimes with information that helps preventing downtime to troubleshoot. With highest level of security and precision control, they can manage networks efficiently through embedded SNMP, QoS, VLAN, and they can provide Precision time synchronization with support for IEEE 1588v2 PTP.

ATOP Layer-3 Switches provide an ideal solution for scaling up industrial networks. Highly reliable, fault tolerant, all certified with EN50155 and EN50121-4, they support IPv4 Static Routing, Dynamic Routing RIPv1/v2, OSPFv2, and multicast protocols such as PIM-DM, PIM-SM, DVMRP. And for high level network security, MACsec Protocol can be used.



24V Compact PoE Injectors

ATOP's advanced harsh-environment PoE Injectors satisfy the need of a rugged, compact, low-cost and high-power PoE injector. IJG7001 has been designed in order to provide an advanced solution that provides up to 60W of PoE power through the newly defined IEEE802.3bt PoE standard guaranteeing at the same time backward support for legacy PoE and PoE+ standards (IEEE802.3af/802.3at).

IJG7000 Series can be powered with as low as 12VDC power input, relieving you in many applications of the hassle of an additional power supply since Machine-Side general-purpose power would be usable and has no limitation on PoE mode A or B as we designed it to be selectable by DIP switch.

24V Compact High-Power PoE Injectors, DIN-Rail mount Metal Housing

NEW

Coming soon!



SKU	Description	10/100 /1000 RJ45 ports (no-PoE)	10/100 /1000 RJ45 ports (PoE)	Additional features
 IJG7001	1-Port High-Power PoE Injector with 12~57VDC power input, supporting PoE Mode A and B (DIP-Switch Selectable)	1	1	supports PoE, PoE+,PoE++

Unmanaged Harsh Environments Switches

Instant connectivity, no set up, plug-and-play, ATOP's Advanced Unmanaged Switches are designed for deployment in harsh and demanding industrial environments.

The key features of this series are the availability of 5 to 7 Gigabit Ethernet ports, embedded Power over Ethernet (PoE) on selected models, and a variety of port configurations – such as RJ45 or SFP. And with UL Class 1 Division 2 Certification plus ATEX Zone 2 certification, this series is suitable for use in locations like mines –environments that have a high risk of explosion.

More Harsh Environment Unmanaged Gigabit switches to follow with additional features, in the next pages..

Unmanaged Gigabit Switches with/without PoE, DIN-Rail mount Metal Housing



SKU	Description	10/100 /1000 RJ45 ports	1000 SFP slots	Max PoE Ports	Additional features
 EHG7305	5-Port Unmanaged Harsh-Env. Gigabit Atex Switch	5	-	-	UL Class 1 Division 2 / ATEX Zone 2 certified EN50155 / EN50121-4 certified
EHG7306-1SFP	6-Port Unmanaged Harsh-Env. Gigabit Atex switch with 1 SFP uplink	5	1	-	
EHG7307-2SFP	7-Port Unmanaged Harsh-Env. Gigabit Atex switch with 2 SFP uplink	5	2	-	
EHG7305-4PoE	5-Port Unmanaged Harsh-Env. Gigabit Atex switch with 4 PoE Ports	5	-	4	
EHG7306-4PoE-1SFP	6-Port Unmanaged Harsh-Env. Gigabit Atex switch with 1 SFP uplink and 4 PoE Ports	5	1	4	
EHG7307-4PoE-2SFP	7-Port Unmanaged Harsh-Env. Gigabit Atex switch with 2 SFP uplink and 4 PoE Ports	5	2	4	

24V PoE Booster Harsh Environments Unmanaged Switches

Take all advantages of Harsh Environment Switches, and add more. Available in 8 or 10-port versions, all Full-Gigabit, selected options allow you to provide PoE power to IP cameras and many more PD devices with a DC power input accepting 12~57V and thus relieving you of installation and cost of an expensive 48V Power supply. EHG6400 Series combines a compact size, up to 120W PoE power budget, CE/FCC/UL and E-Mark certification for usage in on board of vehicles.

Unmanaged Gigabit Switches with PoE booster, DIN-Rail Mount, Metal Housing

NEW Coming soon!

-40°C 75°C E1 Industrial EMC MILD-STD 810F DIN IP30 IEC60529

SKU	Description	10/100 /1000 RJ45 ports	1000 SFP slots	Max PoE Ports	Additional features	
	EHG6408	8-Port Unmanaged Gigabit Ethernet Switch	8	-	-	-
	EHG6410-2SFP	10-Port Unmanaged Gigabit Ethernet Switch with 2 SFP	8	2	-	Version -D allows SFP speed selection
	EHG6408-4PoE-24V	8-Port Unmanaged Gigabit Ethernet Switch with 4 PoE ports, 12 VDC or 24 VDC PoE booster	8	-	4 (24VDC)	PoE voltage booster from 12VDC
	EHG6408-8PoE-24V	8-Port Unmanaged Gigabit Ethernet Switch with 8 PoE ports, 12 VDC or 24 VDC PoE booster	8	-	8 (24VDC)	PoE voltage booster from 12 VDC
	EHG6410-4PoE-24V-2SFP	10-Port Unmanaged Gigabit Ethernet Switch with 2 SFP and 4 PoE, 12~48VDC PoE booster	8	2	4 (24VDC)	PoE booster, -D with SFP speed selection
	EHG6410-8PoE-24V-2SFP	10-Port Unmanaged Gigabit Ethernet Switch with 2 SFP and 8 PoE, 12~48VDC PoE booster	8	2	8 (24VDC)	PoE booster, -D with SFP speed selection

24V PoE Booster Lite-Managed DIN-Rail Switches

Combine the power of **harsh environments capability, compact size, PoE booster** to enable PoE Power with just 12 or 24V power input, **Gigabit speed** and ATOP robustness **with Lite-Management capabilities**. EHG6500 Family can be easily set-up with a User-Friendly **web interface** and be the right solution for **equipping your network of security, monitoring and redundancy** feature without the need to adapt a fully managed, more expensive Switch that in smaller applications will not be exploited at its best. EHG65 supports:

Traffic Optimization

- QoS
- VLAN

Security and Monitoring

- HTTP/HTTPS
- SNMPv1/v2c/v3
- Modbus TCP

Redundancy

- 802.1D-2004 Rapid Spanning Tree Protocol

Lite-Managed Gigabit Switches with PoE booster, DIN-Rail Mount, Metal Housing

NEW Coming soon!

-40°C 75°C RSTP E1 Industrial EMC MILD-STD 810F DIN IP30 IEC60529

SKU	Description	10/100 /1000 RJ45 ports	1000 SFP slots	Max PoE Ports	Additional features	
	EHG6508	8-Port Lite-Managed Gigabit Ethernet Switch	8	-	-	-
	EHG6508-4PoE-24V	8-Port Lite-Managed Gigabit Ethernet Switch with 4 PoE ports, 12 VDC or 24 VDC PoE booster	8	-	4 (24VDC)	PoE voltage booster from 12VDC
	EHG6508-8PoE-24V	8-Port Lite-Managed Gigabit Ethernet Switch with 8 PoE ports, 12 VDC or 24 VDC PoE booster	8	-	8 (24VDC)	PoE voltage booster from 12 VDC
	EHG6510-2SFP	10-Port Lite-Managed Gigabit Ethernet Switch with 2 SFP	8	2	-	Version -D allows SFP speed selection
	EHG6510-4PoE-24V-2SFP	10-Port Lite-Managed Gigabit Ethernet Switch with 2 SFP and 4 PoE, 12~48VDC PoE booster	8	2	4 (24VDC)	PoE booster, -D with SFP speed selection
	EHG6510-8PoE-24V-2SFP	10-Port Lite-Managed Gigabit Ethernet Switch with 2 SFP and 8 PoE, 12~48VDC PoE booster	8	2	8 (24VDC)	PoE booster, -D with SFP speed selection

Industrial Full-Managed PoE Layer-2 Switches

ATOP's advanced Layer-2 Managed Switches for harsh environments provide rugged and reliable solutions for managing advanced networks. This series of switches offers a high degree of link redundancy, flow control, security, and configurability for your network. All models are designed to conform with the strictest Level 3 and 4 EMC compliance requirements. Our components guarantee high-performance, even on full load. ATOP Managed Switches, Profinet CC-B v2.33 certified are the ideal option for Industrial Automation.

Industrial Managed Fast-Ethernet PoE Switches, DIN-Rail Mount



SKU	Description	10/100 RJ45 ports	10/100/1000 RJ45 ports	10/100/1000 SFP slots	1/10 GbE SFP slots	Max PoE Ports
	EH7506-2SFP	6-Port Managed Fast-Ethernet Switch, 2 SFP	4	-	2	-
	EH7506-4PoE-2SFP	6-Port Managed Fast-Ethernet Switch with 4 PoE and 2 SFP	4	-	2	4
	EH7508-4G-4SFP	8-Port Managed Fast-Ethernet Switch with 4 Gigabit Combo uplink ports	4	(4)	(4)	-
	EH7508-4G-4PoE-4SFP	8-Port Managed Fast-Ethernet Switch with 4 Gigabit Combo uplink ports	4	(4)	(4)	4
	EH7512-4G-4SFP	12-Port Managed Fast-Ethernet Switch with 4 Gigabit Combo uplink ports	8	(4)	(4)	-
	EH7512-4G-4PoE-4SFP	12-Port Managed Fast-Ethernet Switch with 4 Gigabit Combo uplink ports and 4 PoE ports	8	(4)	(4)	4
	EH7512-4G-8PoE-4SFP	12-Port Managed Fast-Ethernet Switch with 4 Gigabit Combo uplink ports and 8 PoE ports	8	(4)	(4)	8
	EH7520-4G-4SFP	20-Port Managed Fast-Ethernet Switch with 4 Gigabit Combo uplink ports	16	(4)	(4)	-
	EH7520-4G-4PoE-4SFP	20-Port Managed Fast-Ethernet Switch with 4 Gigabit Combo uplink ports and 4 PoE ports	16	(4)	(4)	4
	EH7520-4G-8PoE-4SFP	20-Port Managed Fast-Ethernet Switch with 4 Gigabit Combo uplink ports and 8 PoE ports	16	(4)	(4)	8

Industrial Managed Gigabit PoE Switches, DIN-Rail Mount





SKU	Description	10/100 RJ45 ports	10/100/1000 RJ45 ports	1000 SFP slots	1/10 GbE SFP slots	Max PoE Ports
	EHG7504	4-Port Managed Gigabit Switch	-	4	-	-
	EHG7504-4PoE	4-Port Managed Gigabit Switch with 4 PoE ports	-	4	-	4
	EHG7504-2SFP	4-Port Managed Gigabit Switch with 2 SFP slots	-	2	2	-
	EHG7504-2PoE-2SFP	4-Port Managed Gigabit Switch with 2 SFP slots and 2 PoE ports	-	2	2	2
	EHG7504-4SFP	4-Port Managed Gigabit Switch with 4 SFP slots	-	-	4	-
	EHG7508	8-Port Managed Gigabit Switch	-	8	-	-
	EHG7508-4SFP	8-Port Managed Gigabit Switch with 4 SFP slots	-	4	4	-
	EHG7508-4PoE-4SFP	8-Port Managed Gigabit Switch with 4 SFP slots and 4 PoE ports	-	4	4	4
	EHG7508-8PoE	8-Port Managed Gigabit Switch with 8 PoE ports	-	8	-	8

Industrial Managed Gigabit PoE Switches with 10GbE SFP uplinks, DIN-Rail Mount

NEW
Coming soon!



SKU	Description	10/100 RJ45 ports	10/100 /1000 RJ45 ports	100/1000 SFP slots	1/10 GbE SFP slots	Max PoE Ports	
	EHG7512-410GSFP	12-Port Managed Din-Rail Gigabit Switch with 4 x 1/10G SFP slots	-	8	-	4	-
	EHG7512-4PoE-410GSFP	12-Port Managed Din-Rail Gigabit Switch with 4 x 1/10G SFP slots and 4 PoE ports	-	8	-	4	4
	EHG7512-8PoE-410GSFP	12-Port Managed Din-Rail Gigabit Switch with 4 x 1/10G SFP slots and 8 PoE ports	-	8	-	4	8
	EHG7512-4SFP-410GSFP	12-Port Managed Din-Rail Gigabit Switch with 4 SFP and 4 x 1/10G slots	-	4	4	4	-
	EHG7512-4SFP-4PoE-410GSFP	12-Port Managed Din-Rail Gigabit Switch with 4 SFP slots, 4 PoE ports and 4 x 1/10G SFP slots	-	4	4	4	4
	EHG7516-410GSFP	16-Port Managed Din-Rail Gigabit Switch with 4 x 1/10G SFP slots	-	12	-	4	-
	EHG7516-4PoE-410GSFP	16-Port Managed Din-Rail Gigabit Switch with 4 x 1/10G SFP slots and 4 PoE ports	-	12	-	4	4
	EHG7516-8PoE-410GSFP	16-Port Managed Din-Rail Gigabit Switch with 4 x 1/10G SFP slots and 8 PoE ports	-	12	-	4	8
	EHG7516-4SFP-410GSFP	16-Port Managed Din-Rail Gigabit Switch with 4 SFP slots and 4 x 1/10G SFP uplinks	-	8	4	4	-
	EHG7516-4SFP-4PoE-410GSFP	16-Port Managed Din-Rail Gigabit Switch with 4 SFP, 4 PoE ports and 4 x 1/10G SFP uplinks	-	8	4	4	4
	EHG7516-4SFP-8PoE-410GSFP	16-Port Managed Din-Rail Gigabit Switch with 4 SFP, 8 PoE ports and 4 x 1/10G SFP uplinks	-	8	4	4	4
	EHG7516-8SFP-410GSFP	16-Port Managed Din-Rail Gigabit Switch with 8 SFP slots and 4 x 1/10G SFP uplinks	-	4	8	4	-
	EHG7516-8SFP-4PoE-410GSFP	16-Port Managed Din-Rail Gigabit Switch with 8 SFP, 4 PoE ports and 4 x 1/10G SFP uplinks	-	4	8	4	4
	EHG7516-12SFP-410GSFP	16-Port Managed Din-Rail Gigabit Switch with 12 SFP slots and 4 x 1/10G SFP uplinks	-	-	12	4	-
	EHG7520-410GSFP	20-Port Managed Din-Rail Gigabit Switch with 4 x 1/10G SFP slots	-	16	-	4	-
	EHG7520-4PoE-410GSFP	20-Port Managed Din-Rail Gigabit Switch with 4 x 1/10G SFP slots and 4 PoE ports	-	16	-	4	4
	EHG7520-8PoE-410GSFP	20-Port Managed Din-Rail Gigabit Switch with 4 x 1/10G SFP slots and 8 PoE ports	-	16	-	4	8
	EHG7520-4SFP-410GSFP	20-Port Managed Din-Rail Gigabit Switch with 4 SFP slots and 4 x 1/10G SFP uplinks	-	12	4	4	-
	EHG7520-4SFP-4PoE-410GSFP	20-Port Managed Din-Rail Gigabit Switch with 4 SFP, 4 PoE ports and 4 x 1/10G SFP uplinks	-	12	4	4	4
	EHG7520-4SFP-8PoE-410GSFP	20-Port Managed Din-Rail Gigabit Switch with 4 SFP, 8 PoE ports and 4 x 1/10G SFP uplinks	-	12	4	4	8
	EHG7520-8SFP-410GSFP	20-Port Managed Din-Rail Gigabit Switch with 8 SFP slots and 4 x 1/10G SFP uplinks	-	8	8	4	-
	EHG7520-12SFP-410GSFP	20-Port Managed Din-Rail Gigabit Switch with 12 SFP slots and 4 x 1/10G SFP uplinks	-	4	12	4	-
	EHG7520-12SFP-4PoE-410GSFP	20-Port Managed Din-Rail Gigabit Switch with 12 SFP, 4 PoE ports and 4 x 1/10G SFP uplinks	-	4	12	4	4
	EHG7520-16SFP-410GSFP	20-Port Managed Din-Rail Gigabit Switch with 16 SFP slots and 4 x 1/10G SFP uplinks	-	-	16	4	-

Layer-3 Managed Switches

ATOP's advanced Layer-3 (L3) Managed Ethernet switches for harsh environments provide a rugged construction and solid hardened specification for managing advanced networks that demand enhanced routing functionality between Different VLANs and IP-Based Routing.

Our high performance L3 switches carry out real-time packet routing based on a local network's IP address (which can get information from connected routes, dynamic routing and manual configured routes) instead of the MAC address of the destination device. This series of switches supports:

- IPv4 Unicast Static Routing
- Dynamic Routing RIP (Routing Information Protocol) V1/V2
- OSPFv2 (Open Shortest Path First)
- VRRP (Virtual Router Redundancy Protocol)
- DVMRP (Distance Vector Multicast Routing Protocol)
- PIM-DM (Protocol Independent Multicast – Dense Mode)
- PIM-SM (Protocol Independent Multicast – Sparse Mode)
- PIM-SSM (Protocol Independent Multicast – Source-Specific Multicast)
- DHCP Server

All models in this series are designed to meet the strictest Level 3 and Level 4 EMC compliance requirements. Our high-performance components guarantee real-time packet switching, even on full load. And they are available in Full-Gigabit versions with 4- to 20-port configurations, RJ45 or SFP connectors, and PoE support.

Layer-3 Managed DIN-Rail Switches

Industrial Layer-3 Managed Gigabit PoE Switches, DIN-Rail Mount



SKU	Description	10/100 RJ45 ports	10/100 /1000 RJ45 ports	1000 SFP slots	1/10 GbE SFP slots	Max PoE Ports
	EHG7604	4-Port Managed Gigabit Switch	-	4	-	-
	EHG7604-4PoE	4-Port Managed Gigabit Switch with 4 PoE ports	-	4	-	4
	EHG7604-2SFP	4-Port Managed Gigabit Switch with 2 SFP slots	-	2	2	-
	EHG7604-2PoE-2SFP	4-Port Managed Gigabit Switch with 2 SFP slots and 2 PoE ports	-	2	2	-
	EHG7604-4SFP	4-Port Managed Gigabit Switch with 4 SFP slots	-	-	4	-
	EHG7608	8-Port Managed Gigabit Switch	-	8	-	-
	EHG7608-4SFP	8-Port Managed Gigabit Switch with 4 SFP slots	-	4	4	-
	EHG7608-4PoE-4SFP	8-Port Managed Gigabit Switch with 4 SFP slots and 4 PoE ports	-	4	4	-
	EHG7608-8PoE	8-Port Managed Gigabit Switch with 8 PoE ports	-	8	-	-

Industrial Managed Layer-3 Gigabit PoE Switches, DIN-Rail Mount

NEW
Coming soon!



SKU	Description	10/100 RJ45 ports	10/100 /1000 RJ45 ports	100/1000 SFP slots	1/10 GbE SFP slots	Max PoE Ports	
	EHG7612-410GSFP	12-Port Managed Din-Rail Layer-3 Gigabit Switch with 4 x 1/10G SFP slots	-	8	-	4	-
	EHG7612-4PoE-410GSFP	12-Port Managed Din-Rail Layer-3 Gigabit Switch with 4x1/10G SFP slots and 4 PoE ports	-	8	-	4	4
	EHG7612-8PoE-410GSFP	12-Port Managed Din-Rail Layer-3 Gigabit Switch with 4x1/10G SFP slots and 8 PoE ports	-	8	-	4	8
	EHG7612-4SFP-410GSFP	12-Port Managed Din-Rail Layer-3 Gigabit Switch with 4 SFP and 4 x 1/10G slots	-	4	4	4	-
	EHG7612-4SFP-4PoE-410GSFP	12-Port Managed Din-Rail L3 Gigabit Switch with 4 SFP, 4 PoE ports, 4x1/10G SFP slots	-	4	4	4	4
	EHG7616-410GSFP	16-Port Managed Din-Rail Layer-3 Gigabit Switch with 4 x 1/10G SFP slots	-	12	-	4	-
	EHG7616-4PoE-410GSFP	16-Port Managed Din-Rail Layer-3 Gigabit Switch with 4x1/10G SFP slots and 4 PoE ports	-	12	-	4	4
	EHG7616-8PoE-410GSFP	16-Port Managed Din-Rail Layer-3 Gigabit Switch with 4x1/10G SFP slots and 8 PoE ports	-	12	-	4	8
	EHG7616-4SFP-410GSFP	16-Port Managed Din-Rail L3 Gigabit Switch with 4 SFP slots and 4 x 1/10G SFP uplinks	-	8	4	4	-
	EHG7616-4SFP-4PoE-410GSFP	16-Port Managed Din-Rail L3 Gigabit Switch with 4 SFP, 4 PoE ports, 4x1/10G SFP uplinks	-	8	4	4	4
	EHG7616-4SFP-8PoE-410GSFP	16-Port Managed Din-Rail L3 Gigabit Switch with 4 SFP, 8 PoE ports, 4x1/10G SFP uplinks	-	8	4	4	4
	EHG7616-8SFP-410GSFP	16-Port Managed Din-Rail Layer-3 Gigabit Switch with 8 SFP slots and 4 x 1/10G SFP	-	4	8	4	-
	EHG7616-8SFP-4PoE-410GSFP	16-Port Managed Din-Rail Gigabit Switch with 8 SFP, 4 PoE ports and 4 x 1/10G SFP uplinks	-	4	8	4	4
	EHG7616-12SFP-410GSFP	16-Port Managed Din-Rail Layer-3 Gigabit Switch with 12 SFP slots and 4 x 1/10G SFP	-	-	12	4	-
	EHG7620-410GSFP	20-Port Managed Din-Rail Layer-3 Gigabit Switch with 4 x 1/10G SFP slots	-	16	-	4	-
	EHG7620-4PoE-410GSFP	20-Port Managed Din-Rail Layer-3 Gigabit Switch with 4x1/10G SFP slots and 4 PoE ports	-	16	-	4	4
	EHG7620-8PoE-410GSFP	20-Port Managed Din-Rail Layer-3 Gigabit Switch with 4x1/10G SFP slots and 8 PoE ports	-	16	-	4	8
	EHG7620-4SFP-410GSFP	20-Port Managed Din-Rail Layer-3 Gigabit Switch with 4 SFP slots and 4x1/10G SFP slots	-	12	4	4	-
	EHG7620-4SFP-4PoE-410GSFP	20-Port Managed Din-Rail L3 Gigabit Switch with 4 SFP, 4 PoE ports, 4x1/10G SFP uplinks	-	12	4	4	4
	EHG7620-4SFP-8PoE-410GSFP	20-Port Managed Din-Rail L3 Gigabit Switch with 4 SFP, 8 PoE ports, 4x1/10G SFP uplinks	-	12	4	4	8
	EHG7620-8SFP-410GSFP	20-Port Managed Din-Rail Layer-3 Gigabit Switch with 8 SFP slots and 4x1/10G SFP slots	-	8	8	4	-
	EHG7620-12SFP-410GSFP	20-Port Managed Din-Rail L3 Gigabit Switch with 12 SFP slots and 4x1/10G SFP uplinks	-	4	12	4	-
	EHG7620-12SFP-4PoE-410GSFP	20-Port Managed Din-Rail L3 Gigabit Switch with 12 SFP, 4 PoE ports, 4x1/10G SFP uplinks	-	4	12	4	4
	EHG7620-16SFP-410GSFP	20-Port Managed Din-Rail L3 Gigabit Switch with 16 SFP slots and 4x1/10G SFP uplinks	-	-	16	4	-

Rack-Mount Managed Switches

Flexibility

You can choose from among 16 different Switching or Layer-3 Routing Core versions (based on power supply and uplink port configurations) and five different 4- to 8-Port modules to customize your device in a very simple way.

Designed for PoE

RHG7X28 supports up to 24 Gigabit ports in any 4- or 8-port configuration. Specifically designed to bring power through Ethernet cables to virtually anywhere, a maximum output Power over Ethernet of 720W over the 24 ports can be achieved (PoE/PoE+configuration - 802.3af/at).



Available in **3 power input variants**, RHG7X28 is UL/EN62368 certified by specifying the complete safety requirements for control equipment and designed to handle the harshest of environments. Its fanless design and EMC Level 3 protection guarantees operations in wide temperatures from -40°C to +75°C, and with 24 PoE ports running full power, it is sort the of device that can be trusted to work in your field or environment with minimum effort.

Power and versatility

Layer-3 versions support IPv4 and IPv6 Static Routing to power communication to indirectly connected remote networks. Layer 3 routing rich features further include RIPv1/v2, OSPFv2, PIM Dense Mode and Sparse Mode, DVMRP and VRRP for Routing Redundancy. Through ERPS, RHG7X28 supports a network self-recovery time of under 20ms – even on full load. Most redundant ring topologies are supported: they are ITU-T G.8032 ERPS Ring, IEEE802.1D-2004 RSTP, STP, MSTP, MRP (Client), iA-Ring, iA-Chain and many other compatible rings.

Secure

The first Industrial Managed Secure Switch! Protect your LAN from eavesdropping, tempering and impersonation through 802.1AE MACsec hop-by-hop encryption. With no additional latency and 100% Gigabit throughput guaranteed, dedicated modules provide you with the ultimate security solution (Layer-3 version only) – enabling shorter time to task completion ratio.

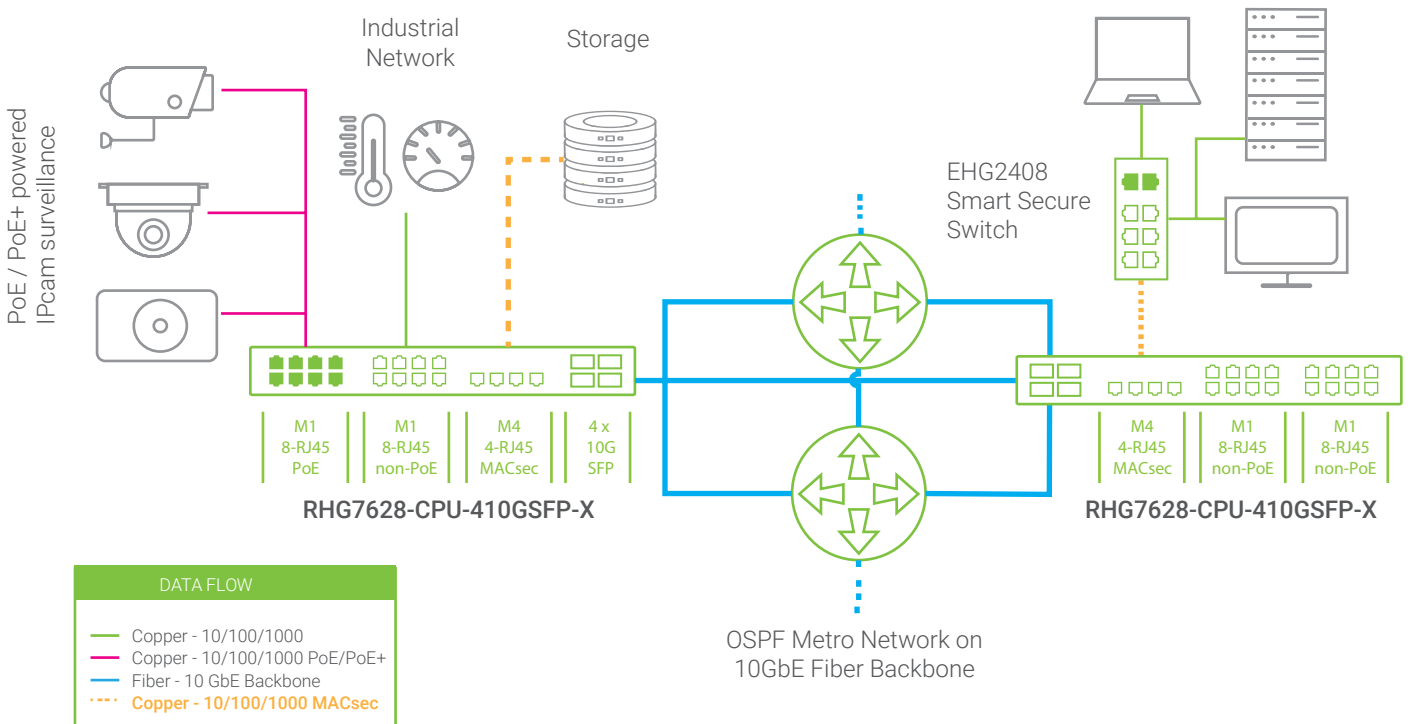

Modular Concept

Scalable, flexible, a custom device can be built as per specification for optimized utilization and efficiency. Capability can be added with time and changing demand by choosing from among five different hardware versions and five different 4- or 8-port swappable modules. The corresponding software detects the connected module and enables the related set-up panels automatically, saving configuration and installation times.



RHG7628-CPU-410GSFP-R Main unit, with 4 x 10 Gigabit SFP uplink ports and redundant AC power input



RHG7X28-M1
8-port Gigabit RJ45 PoE module

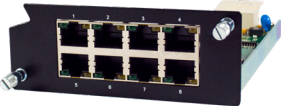

RHG7X28-M2
8-port Gigabit RJ45 module



RHG7X28-M5
8-port Gigabit SFP MACsec Module

24 port L3 Managed Switch, with 8 Gigabit PoE, 8 Gigabit RJ45, 4 Gigabit SFP MACsec and 4 x 10 GbE uplink ports



Switch Core Platforms

ATOP's scalable and secure rack-mounted switches provide 4 different hardware versions, whether you need Layer-2 or Layer-3 Switching, and 4 x 10 Gigabit uplink ports, there is always one from us.

For specific Layer-2 and Layer-3 features, please refer to their respective data-sheets.

Industrial Rack-Mount Gigabit Managed Switch



Layer	Uplink ports	Redundant power supply for CPU board (100~240 VAC)	Single power supply for CPU board (100~240 VAC)	Redundant AC/DC power input for the power board	Redundant DC 48~56V power supply
Layer 2*	4 x 1 GbE	RHG7528-CPU-4SFP-R	RHG7528-CPU-4SFP	RHG7528-CPU-4SFP-MR	RHG7528-CPU-4SFP-DC
	4 x 10 GbE	RHG7528-CPU-410GSFP-R	RHG7528-CPU-410GSFP	RHG7528-CPU-410GSFP-MR	RHG7528-CPU-410GSFP-DC
Layer 3	4 x 1 GbE	RHG7628-CPU-4SFP-R	RHG7628-CPU-4SFP	RHG7628-CPU-4SFP-MR	RHG7628-CPU-4SFP-DC
	4 x 10 GbE	RHG7628-CPU-410GSFP-R	RHG7628-CPU-410GSFP	RHG7628-CPU-410GSFP-MR	RHG7628-CPU-410GSFP-DC

* Layer 2 models do not support MACsec M4-M5 modules

Modules

Five different swappable modules are available for the RHG7X28 Series, available in up to 74 combinations, in 8 port Gigabit PoE, non PoE and 100/1000 SFP modules. Allows you flexibility for specific application.

a. RHG7X28-M1- 8-Port RJ45 PoE module:

- i. 8 RJ45 10/100/1000 BaseT(X) ports
- ii. 30 W PoE Power per port (802.3af, 802.3at)
- iii. 240 W Maximum PoE power per module



b. RHG7X28-M2- 8-Port RJ45 module:

- i. 8 RJ45 10/100/1000 BaseT(X) ports

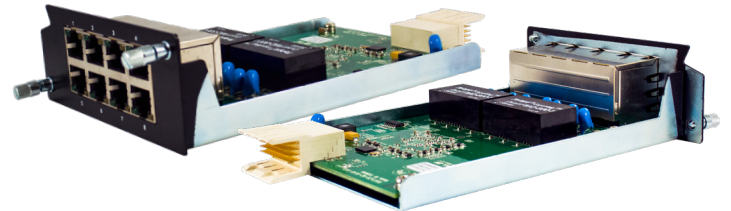

c. RHG7X28-M3- 8-Port SFP module:

- i. 8 SFP 100/1000 BaseF(X) slots
- ii. Speed software-selectable

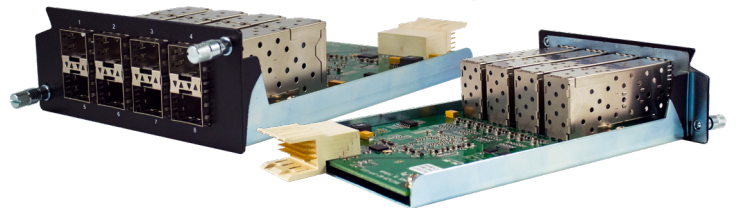

d. RHG7X28-M4- 4-Port RJ45 MACsec module (*):

- i. 4 RJ45 10/100/1000 BaseT(X) ports
- ii. MACsec Hardware encryption on all ports

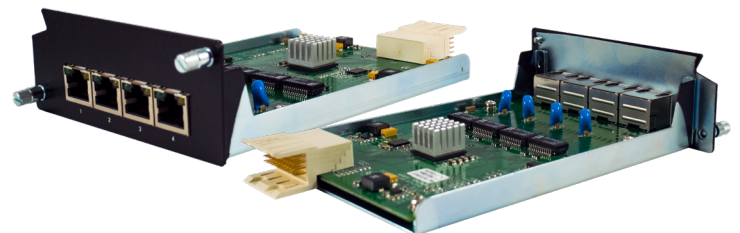

e. RHG7X28-M5- 4-Port SFP MACsec module (*):

- i. 4 SFP 100/1000 BaseF(X) slots
- ii. MACsec Hardware encryption on all ports

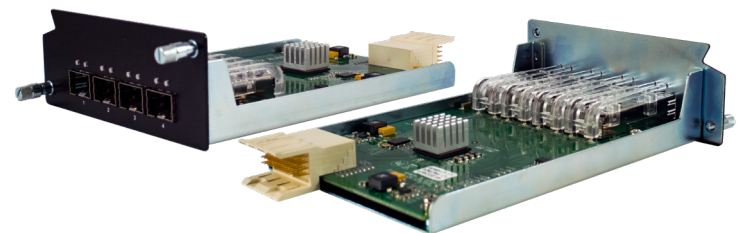

* Layer 2 CPU-core models (RHG7528-CPU-XX) do not support MACsec M4-M5 modules.

Industry-specific Ethernet Switches

ATOP's wide range of resilient and easy-to-deploy industrial Ethernet switches are engineered and manufactured in Taiwan. Equipped with industrial-grade reliability, network redundancy, scalability, seamless integrated security and industrial certifications; our solutions are optimized for performance, efficiency and best price-to-performance ratio. With our abundance of product options across Unmanaged, Managed and Rackmount Switches in conjunction with extensive knowledge of various protocol standards used in industries such as railway, transport, energy, and utilities, we can be sure to find a solution for your application – regardless of its environment and scale.

Industry Ethernet for Substation Automation and Smart Grids

Over the decades, various communication protocols have been developed to manage power grid networks and components such as RTUs and IEDs – and even control centers. This results to adoption of different standards by numerous countries around the world. While different protocols have varying strengths and dynamics, Distributed Network Protocol (DNP 3) has become the standard adopted in North America. Europe has relied mainly on IEC 60870-5 101/103/104, with much of the world using Modbus protocol in tightly controlled communication dynamics, due to its openness and ease.

To simplify all these and interoperability, IEC 61850 was developed to provide a standard communication protocol for substations and power grid automation. Specializing its domain knowledge in power grid substations, IEC 61850 is an object-oriented, Ethernet based protocol that uses a data modeling to clearly describe each component of a power grid or substation as standard logical nodes – such as object processes, protection, control, and functionality to perform monitoring, metering, real-time protection and control.

This specialization enables data access to the power grid system to yield more details. And to further improve reliability and performance, **IEC 61850 Part 3 also specifies the hardware and network suitability requirements** – such as electro-magnetic immunity (EMI), intelligent electronic devices, surge protection, vibration and shock resistance, and the temperature range in which devices must be able to function. **ATOP's IEC61850-3 switches comply with these specifications.**

IEC 61850-3 Device Compliancy Specifications

- Operate in a temperature range of -40°C to 85°C.
- Be capable of reliably handling long distance transmissions through Fiber optic connectivity.
- Guarantee QoS (Quality of Service) management and real-time packet switching for GOOSE event messages.
- Guarantee a level of redundancy that minimizes packet loss. Ring topologies should be supported, and zero-packet-loss technologies such as HSR (High availability Seamlessly Redundancy) or PRP (Parallel Redundancy Protocol) are strongly recommended to be supported. ATOP's devices support RSTP (Rapid Spanning-Tree Protocol) and ERPS rings. When equipped with HSR/PRP modules, our innovative RHG9528 switch guarantees against loss of GOOSE packets.
- Comes with a wide tolerance for vibrations and shocks. ATOP's MIL-STD-810F device fully complies.
- Comes with a tough electromagnetic immunity and complies with emission standards according to IEC 61850-3.
- Comes with at least Level 3 EMC protection; have at least Level 4 ESD, EFT and Surge protection; and have at least Level 5 PFMF and Damped Oscillatory Magnetic Field immunity.





Test	Version	Item		Value	Level	Criterion
IEC 61000-4-2	2008	ESD	Contact Discharge AirDischarge	±8KV ±15KV	4 4	B B
IEC 61000-4-3	2010	RS	Enclosure Port	10(V/m), 80-1000MHz, 80% AM, 1G~3GHz	3	A
IEC 61000-4-4	2012	EFT	AC Power Port DC Power Port Signal Port	±4.0KV@ 2.5KHz ±4.0KV@ 2.5KHz ±2.0KV@ 5.0KHz	4 4 4	B B B
IEC 61000-4-5	2014	Surge	AC Power Port AC Power Port DC Power Port DC Power Port Signal Port	Line-to Line±2.0KV Line-to Earth±4.0KV Line-to Line±1.0KV Line-to Earth±2.0KV Line-to Earth±4.0KV	4 4 3 3 4	B B B B B
IEC 61000-4-6	2013	CS	AC Power Port DC Power Port Signal Port	10V, 150KHz~80MHz, 80%AM 10V, 150KHz~80MHz, 80%AM 10V, 150KHz~80MHz,80%AM	3 3 3	A A A
IEC 61000-4-8	2009	PFMF	(Enclosure)	100A/m continuous,1000A/m for 3S	5	A
IEC61000-4-10	2000	Damped Oscillatory magnetic Field	(Enclosure)	100A/m,100KHz,1MHz	5	A
IEC 61000-4-11	2004	DIP	AC Power Port	Drop 70% for 3 times/S (1 Period) Drop 40% for 3 times/1mS (50 Period) Drop 100% for 3 times/50mS (5 & 50 Period)	N/A N/A N/A	A A A
IEC 61000-4-12	2006	Damped Oscillatory	AC Power Port Signal Port	2.5KV common,1KV differential mode @ 1MHz 2.5KV common,1KV differential mode @ 1MHz	3 3	B B

IEC 61850-3 DIN-Rail Managed Gigabit Switches

IEC 61850-3 Certified Managed Gigabit Switches, DIN-Rail Mount



SKU	Description	10/100 / 1000 RJ45 ports	1000 SFP slots	Total Ports	Power Input
 EHG9508-2SFP	8-Port IEC 61850-3 certified Managed Gigabit Switch, with 2 Gigabit SFP slots,	6	2	8	Dual 24~57 VDC input
EHG9508-2SFP-HV	8-Port IEC 61850-3 certified Managed Gigabit Switch, with 2 Gigabit SFP slots, High Voltage	6	2	8	Dual 110~370 VDC input
EHG9508-2SFP-AC	8-Port IEC 61850-3 certified Managed Gigabit Switch, with 2 Gigabit SFP slots, AC input	6	2	8	Dual 100~240 VAC input
 EHG9512-4SFP	12-Port IEC 61850-3 certified Managed Gigabit Switch, with 8 Gigabit SFP slots	8	4	12	Dual 24~57 VDC input
EHG9512-4SFP- HV	12-Port IEC 61850-3 certified Managed Gigabit Switch, with 8 Gigabit SFP slots, High Voltage	8	4	12	Dual 110~370 VDC input
EHG9512-4SFP- AC	12-Port IEC 61850-3 certified Managed Gigabit Switch, with 8 Gigabit SFP slots, AC input	8	4	12	Dual 100~240 VAC input

IEC 61850-3 Rack-Mount Managed Gigabit Switch

RHG9528 is a modular, rack-mounted, and IEC61850-3-certified Managed Switch, ideal for substation automation. Its modular architecture allows you to customize the device to your specific applications.



Conceived for telecom and power applications, the modular architecture of RHG9528 allows it to be deployed simply as either a managed switch, Access/Aggregation switch, a PTP Transparent clock, a PTP Boundary clock, a SyncE clock, or as a IEC62439-3 (HSR) and IEC62439-4 (PRP) device. Its rugged design, wide temperature range and high EMC protection, combined with IEC61850-3 and IEEE1613 certifications for the Power Sector, makes the RHG9528 Series an ideal solution for IEC61850 substation use.

Its rugged design, wide temperature range and high EMC protection, combined with IEC61850-3 and IEEE1613 certifications for the Power Sector, makes the RHG9528 Series an ideal solution for IEC61850 substation use.

High Availability for zero packet loss (HSR/PRP)

When equipped with High-Availability HSR/PRP modules, the RHG9528 series complies with the most stringent redundancy requirements. It ensures zero packet loss, no misoperation or damage and that GOOSE packets/messages arrive at their intended destination. It also provides a network redundant self-recovery time of under 20ms, even on full load, which enables a reliable network to be built with almost any redundant ring topology using traditional redundancy protocols. RHG9528 supports: ITU-T G.8032 ERPS Ring; IEEE802.1D-2004 RSTP; STP; MSTP; MRP (Client); iA-Ring; iA-Chain; and many other compatible rings protocols for network redundancy. And with a Multifunctional web dashboard, it offers intelligent features such as Quality of service (QoS), IGMP, and Port mirroring.

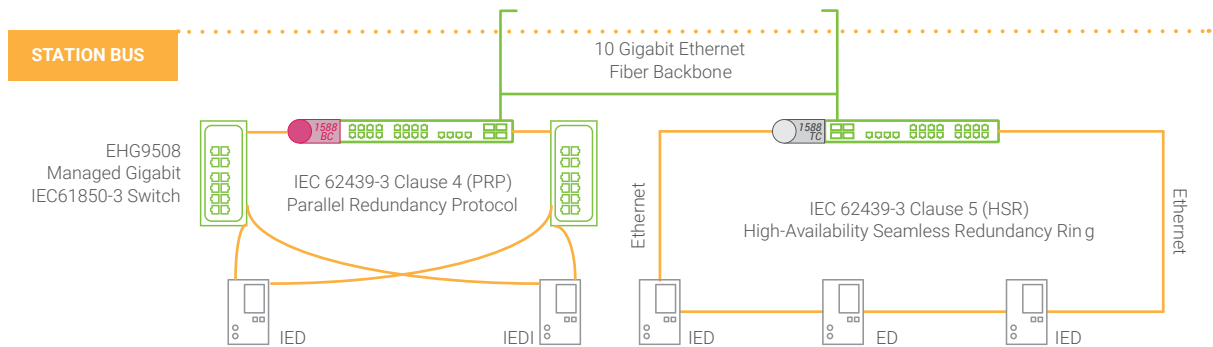

IEEE1588v2 PTP Transparent and Boundary Clock

In Telecom applications, there can be millions of cells that need to be synchronized, which can often lead to bottlenecks on CPU load of the Grandmaster and the physical links close to it.

Not only in Telecom applications, but also in Power applications, Boundary Clocks are very commonly used to combat this.

A Boundary Clock device is usually embedded inside a Managed Switch. It acts as a Slave to a GMC and as a Master to all slaves that are downstream. By setting up this intermediate layer, the GMC takes care of the synchronization of Boundary Clocks (BCs) only, and BCs will either sync with the slaves themselves or other Boundary Clocks, and so on.

A good BC, like the GM, must have hardware-generated accurate Timestamps, and should be equipped with an internal good Oscillator to limit time-drift – in case the GM should unexpectedly fail or a network link upstream has an issue.

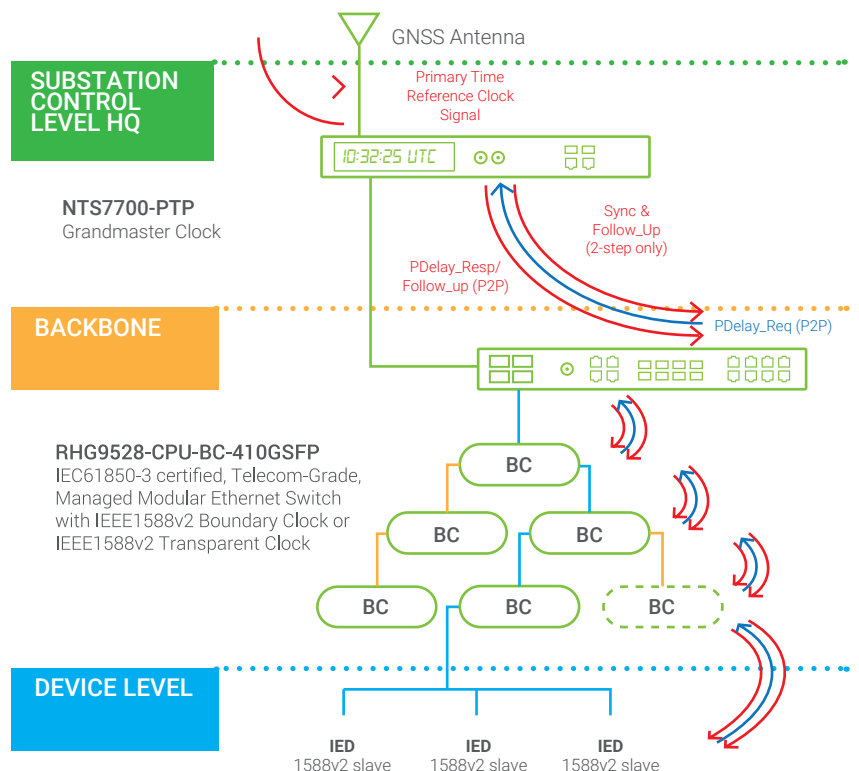





IEC 61850-3 Certified Managed Gigabit Switches, PTP, HSR/PRP Series, Rack-Mount

NEW
Coming soon!



SKU	Description	1/10G SFP Uplinks	Slots	Additional features	
	RHG9528-CPU-410GSFP-DC	Modular IEC61850-3 Managed Switch Core, 3 modules, DC	4	3	24~120VDC power input
	RHG9528-CPU-410GSFP-AC	Modular IEC61850-3 Managed Switch Core, 3 modules, AC	4	3	90~264VAC power input
	RHG9528-CPU-410GSFP-HV	Modular IEC61850-3 Managed Switch Core, 3 modules, High-voltage DC	4	3	120~370VDC power input
	RHG9528-CPU-410GSFP-SB-DC	Modular IEC61850-3 Managed Switch Core with Boundary clock, 3 m., DC	4	3	Hardware-boundary clock 24~120VDC power input
	RHG9528-CPU-410GSFP-SB-AC	Modular IEC61850-3 Managed Switch Core with Boundary clock, 3 m., AC	4	3	Hardware-boundary clock 90~264VAC power input
	RHG9528-CPU-410GSFP-SB-HV	Modular IEC61850-3 Managed Switch Core with Boundary clock, 3 m., HV DC	4	3	Hardware-boundary clock 120~370VDC power input

Modules

SKU	Description	10/100 /1000 RJ45	100 /1000 SFP	Additional features	
	RHG9528-M1	8-Port Gigabit RJ45 Module	8	-	
	RHG9528-M2	8-Port Gigabit SFP Module	-	8	
	RHG9528-M3	4-port Gigabit RJ45 module, with RS-485 IRIG-B output	4	-	IRIG-B output (terminal block)
	RHG9528-M4	4-port Gigabit SFP module, with RS-485 IRIG-B output	-	4	IRIG-B output (terminal block)
	RHG9528-M5	4-port Gigabit RJ45 HSR/PRP module, working as HSR/PRP/Quadbox/etc..	4	-	HSR/PRP/Redbox/Quadbox
	RHG9528-M6	4-port Gigabit SFP HSR/PRP module, working as HSR/PRP/Quadbox/etc..	-	4	HSR/PRP/Redbox/Quadbox

Railway Networking: EN50155 and EN50121-4

EN50155 is widely recognized international standard for electronic equipment in railway applications. It defines the criteria that network devices must comply with – such as wide temperature ranges; humidity, shock, and vibration resistance; power supplies, electromagnetic interference, power surges, EMC, electrostatic discharges (ESD) and transient factors.

EN50121-4 instead, even though being part of EN50155, applies to the signaling and track-side apparatus installed in railway environments.

ATOP's railway compliant, EN50155 and EN50121-4 certified product Series offer powerful industrial ethernet switches with advanced features that are encased in robust and reliable housing up to IP67, making them highly suitable for use in signal control networks.

Selected products are **NEMA TS-2** certified, allowing them to be used in the most demanding of traffic control applications



Mechanical requirements

• Rolling stock

- Vibration: Category < 0.3 Kg
- Frequency range: 5 – 150 Hz
- Acceleration: 5g
- Shock (half sinus): Long/ Trans. /Vert Axis - Peak acceleration: 5g/2g/1g
- Duration: 50 ms / 20 ms / 20 ms

• Ground equipment N/A

Temperature Requirements

Category	Internal cabinet temperature range	Ambient board temperature range	GAIA converter modules temperature range
T1	-25/55 °C	-25/70 °C	Industrial line: -40/71 °C ambient
T2	-40/55 °C	-40/70 °C	Industrial line: -40/71 °C ambient
T3	-25/70 °C	-25/85 °C	Hi-rel line: -40/85 °C ambient
T4	-40/70 °C	-40/85 °C	Hi-rel line: -40/85 °C ambient

Humidity EN50155 2 x 25h 40

Electromagnetic compatibility

- CE; FCC
- 24 VDC: 500 Veff/ 50 Hz/ 1 min
- 48 VDC: 500 Veff/ 50 Hz/ 1 min
- 72~125 VDC : 1,000 Veff/ 50 Hz/ 1 min
- 125~315 V: 1,500 Veff/ 50 Hz/ 1 min
- For other details refer to EN50155

Possible topologies

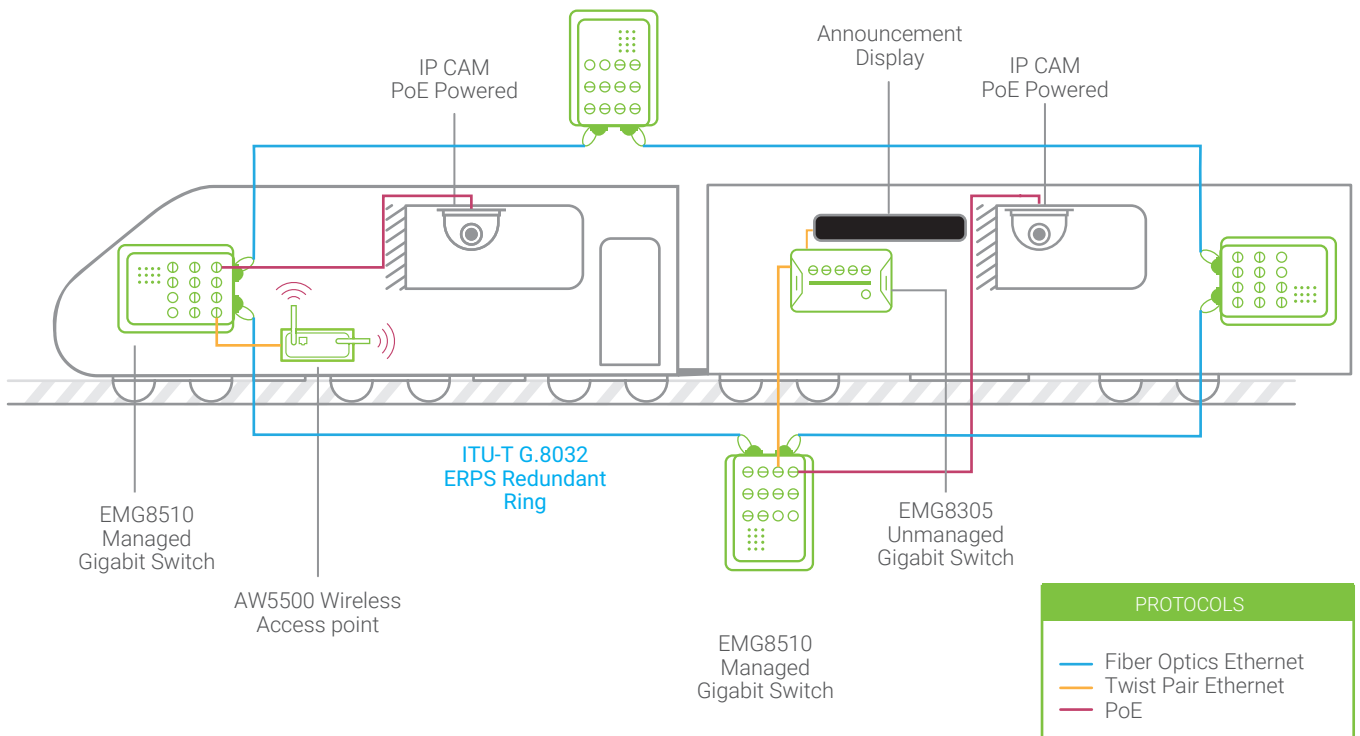

EN50155 Railway Unmanaged Switches

Unmanaged Fast-Ethernet Switches, Gigabit Uplink, DIN-Rail Mount



SKU	Description	10/100 RJ45 ports	10/100 / 1000 RJ45	1000 SFP slots	100 Fiber Ports	1000 Fiber Ports
	EH7310-G	10-Port Unmanaged Ethernet Switch with 2 Gigabit RJ45 uplink ports	8	2	-	-
	EH7310-G-2Fm	10-Port Unmanaged Ethernet Switch with 2 Gigabit Multi-mode Fiber Optic Uplinks	8	-	-	2 (m)
	EH7310-G-2Fs	10-Port Unmanaged Ethernet Switch with 2 Gigabit Single-mode Fiber Optic Uplinks	8	-	-	2 (s)
	EH7310-2Fm	10-Port Unmanaged Ethernet Switch with 2 Multi-mode Fiber Optic Uplinks	8	-	-	2 (m)
	EH7310-2Fs	10-Port Unmanaged Ethernet Switch with 2 Single-mode Fiber Optic Uplinks	8	-	-	2 (s)

Unmanaged Gigabit Switches with/without PoE, DIN-Rail Mount Metal Housing



SKU	Description	10/100 /1000 RJ45 ports	1000 SFP slots	Max PoE Ports	Additional features
	EHG7305	5-Port Unmanaged Harsh-Env. Gigabit ATEX Switch	5	-	EN50155 Rolling stock / EN50121-4 Trackside / UL Class 1 Division 2 / ATEX Zone 2 certified
	EHG7306-1SFP	6-Port Unmanaged Harsh-Env. Gigabit ATEX switch with 1 SFP uplink	5	1	
	EHG7307-2SFP	7-Port Unmanaged Harsh-Env. Gigabit ATEX switch with 2 SFP uplink	5	2	
	EHG7305-4PoE	5-Port Unmanaged Harsh-Env. Gigabit ATEX switch with 4 PoE Ports	5	-	
	EHG7306-4PoE-1SFP	6-Port Unmanaged Harsh-Env. Gigabit ATEX switch with 1 SFP uplink and 4 PoE Ports	5	1	
	EHG7307-4PoE-2SFP	7-Port Unmanaged Harsh-Env. Gigabit ATEX switch with 2 SFP uplink and 4 PoE Ports	5	2	

Unmanaged Waterproof Gigabit Switches, Field Mount, Aluminum Housing



SKU	Description	10/100 M12 ports	10/100 / 1000 M12 ports	M12 Type	Additional features	
	EMG8305-M12-A	5-Port IP67 Unmanaged Gigabit Switch with M12 connectors, A-coding	-	5	A coding	Profinet packet prioritization
	EMG8305-M12-X	5-Port IP67 Unmanaged Gigabit Switch with M12 connectors, X-coding	-	5	X coding	Profinet packet prioritization

EN50155 Managed Switches



Industrial Managed Gigabit PoE Switches, DIN-Rail Mount



SKU	Description	10/100 RJ45 ports	10/100 /1000 RJ45 ports	1000 SFP slots	1/10 GbE SFP slots	Max PoE Ports
	EHG7504	4-Port Managed Gigabit Switch	4	-	-	-
	EHG7504-4PoE	4-Port Managed Gigabit Switch with 4 PoE ports	4	-	-	4
	EHG7504-2SFP	4-Port Managed Gigabit Switch with 2 SFP slots	2	2	-	-
	EHG7504-2PoE-2SFP	4-Port Managed Gigabit Switch with 2 SFP slots and 2 PoE ports	2	2	-	2
	EHG7504-4SFP	4-Port Managed Gigabit Switch with 4 SFP slots	-	4	-	-
	EHG7508	8-Port Managed Gigabit Switch	8	-	-	-
	EHG7508-4SFP	8-Port Managed Gigabit Switch with 4 SFP slots	4	4	-	-
	EHG7508-4PoE-4SFP	8-Port Managed Gigabit Switch with 4 SFP slots and 4 PoE ports	4	4	-	4
	EHG7508-8PoE	8-Port Managed Gigabit Switch with 8 PoE ports	8	-	-	8

Managed Waterproof Gigabit Switches, Field-Mount, Aluminum Housing



SKU	Description	10/100 M12 ports	10/100 / 1000 M12 ports	1000 SFP slots	Max PoE Ports
	EMG8508	8-Port IP67 Managed Gigabit Switch	8	-	-
	EMG8508-4PoE	8-Port IP67 Managed Gigabit Switch with 4 PoE ports	8	-	4
	EMG8508-8PoE	8-Port IP67 Managed Gigabit Switch with 8 PoE ports	8	-	8
	EMG8508-HV	8-Port IP67 Managed Gigabit Switch, 50~145 VDC power input	8	-	-
	EMG8510-2SFP	10-Port IP67 Managed Gigabit Switch, with 2 Gigabit SFP ports	8	2	-
	EMG8510-4PoE-2SFP	10-Port IP67 Managed Gigabit Switch, with 2 Gigabit SFP ports and 4 PoE ports	8	2	4
	EMG8510-8PoE-2SFP	10-Port IP67 Managed Gigabit Switch, with 2 Gigabit SFP ports and 8 PoE ports	8	2	8
	EMG8510-2SFP-HV	10-Port IP67 Managed Gigabit Switch, with 2 Gigabit SFP ports, 50~145 VDC power input	8	2	-

Industrial Wireless

Securely with state-of-the-art encryption extend connectivity beyond four walls of the building, ATOP's Industrial Wireless Access Points (AP) provide reliable, robust, rugged, and cost-effective solutions for industrial applications that require wireless connectivity.

ATOP's APs (selected versions) are equipped with a powerful MIMO Radio interface that supports IEEE 802.11 a/b/g/n, 2.4 GHz and 5 GHz selectable bands. They can run in multiple modes, such as Access Point (AP) mode, Wireless Distribution Bridge (WDS) mode or Access Point (AP) Client Operation mode.

The devices are designed to be fully operational between -10°C and +60 °C or more, and they also feature built-in DIN-Rail mounts.



Industrial Wireless Access Point, IEEE 802.11 a/b/g/n, DIN-Rail Metal Housing

NEW
Coming soon!



SKU	Description	10/100 RJ45 ports	SFP slots	Additional Features
 AW5200	IEEE 802.11 b/g/n Entry-Level Access Point/ Client	2	-	-

Industrial Wireless Access Point, IEEE 802.11 a/b/g/n, DIN-Rail Metal Housing



SKU	Description	10/100 /1000 RJ45	SFP slots	Fiber ports	Additional features
 AW5500	IEEE 802.11 a/b/g/n Access Point/ Bridge/Client	1	-	-	2.4GHz, 5.0GHz MIMO

Industrial Wireless Access Point, IEEE 802.11 b/g/n, DIN-Rail Metal Housing



SKU	Description	10/100 /1000 RJ45	SFP slots	Fiber ports	Additional features
 AW5500C	IEEE 802.11 b/g/n Access Point/ Bridge/Client Supporting WiFi direct	1	-	-	WPS button

Industrial Wi-Fi Mesh

In a smart factory or industrial operation, a robust, fault free communication network is extremely important to weave a resilient network in indoor environments and provide a cost-effective, easy solution to ensure uninterrupted data transmission.

Many such facilities are in harsh terrains, where deploying a wired network is not possible, hence going wireless holds the key. In normal wireless topologies every end-node is connected to the centralized Access Point and with a suddenly disabled or out of range AP the section of the network connected to that Access Point would collapse. However, Wi-Fi Mesh is different. In the mesh topology every node acts as an end device or a forwarding node thus minimizing network disablement. An open-ended infrastructure of nodes are wirelessly connected and rely on each other to extend a radio signal (Wi-Fi) to route, relay and proxy traffic to and from clients.

ATOP's Wi-Fi Mesh device simplifies the deployment of wireless networks in factories, warehouses or industrial facilities allowing field data to fly even when section of the network are in movement. The self-forming, self-healing nature ensures that the other elements of the mesh would channel the information through a different path. If purchased in the SDK version, creating applications to run on the nodes forming the network is fast, efficient and updated over-the-air. While the maximum wireless throughput stands at 100 Mbps (UDP), roaming speed goes up to 1500ms.

Besides mesh, the device can still do the legacy functions such as standard AP or STA (client). With optional PoE power or additional Serial ports, the device is also available as a Serial Server /Protocol Gateway / Modbus Gateway.



Industrial Advanced Wi-Fi Access Point, IEEE 802.11 a/b/g/n, DIN-Rail, Metal Housing

NEW
Coming soon!



SKU	Description	10/100 RJ45	Wireless Modules	Fiber ports	Additional features
 AW5900	Industrial 802.11 a/b/g/n WiFi-Mesh Wireless AP/Client, 2x 10/100 RJ45 Ports	2	1 Wi-Mesh	-	2.4GHz 2x2 MIMO, 5.0GHz 2x1 SISO WPS button
AW5900-PoE	Industrial 802.11 a/b/g/n WiFi-Mesh Wireless AP/Client, 2x 10/100 RJ45 Ports, PoE PD	2	1 Wi-Mesh	-	2.4GHz 2x2 MIMO, 5.0GHz 2x1 SISO WPS, PoE PD
AW5900-N	Industrial 802.11 a/b/g/n WiFi-Mesh Wireless AP/Client, Mesh Node only	2	1 Wi-Mesh	-	
AW5900-4G	Industrial 802.11 a/b/g/n WiFi-Mesh Wireless AP/Client with 4G, 2x 10/100 RJ45 Ports	2	1 Wi-Mesh 1 LTE	-	Wi-Fi Module and 4G LTE module, WPS
AW5900-4G-PoE	Industrial 802.11 a/b/g/n WiFi-Mesh Wireless AP/Client with 4G, 2x 10/100 RJ45 Ports, PoE PD	2	1 Wi-Mesh 1 LTE	-	Wi-Fi Module and 4G LTE module, WPS, PoE PD

Media Converters

From entry-level Media converters to advanced smart versions, ATOP's media converters are ideal for transitioning from copper-based to fiber-based networks. They provide reliable solutions to all conversions between single-mode or multi-mode optics to Ethernet conversion.

All products in this series are suitable for operational temperatures from -20°C to +70°C. Selected versions can operate in temperatures between -40°C and +70°C. And they come with redundant power supplies and automatic speed negotiation.



Industrial Smart Ethernet to Fiber converter, Auto Speed Negotiation, DIN-Rail Mount



SKU	Description	10/100 RJ45 ports	10/100 /1000 RJ45 ports	Auto Negotiation SFP slots	Fiber ports	Rated distance	
	EF23-1-1Fm-SC-2	Fast Ethernet to Fiber converter, SC connector, multi-mode, 2km	1	-	1 (multi-mode)	2 km	
	EF23-1-1Fs-SC-30	Fast Ethernet to Fiber converter, SC connector, single-mode, 30km	1	-	1 (single-mode)	30 km	
	EF24-1G-1Fm-SC-550M	Gigabit Ethernet to Fiber converter, SC connector, multi-mode, 550m	-	1	-	1 (multi-mode)	550 m
	EF24-1G-2Fm-SC-550M	Gigabit Ethernet to Fiber converter and repeater, SC connector, multi-mode, 550m	-	1	-	2 (multi-mode)	550 m
	EF24-1G-1Fs-SC-10K	Gigabit Ethernet to Fiber converter, SC connector, single-mode, 10 km	-	1	-	1 (single-mode)	10 Km
	EF24-1G-2Fs-SC-10K	Gigabit Ethernet to Fiber converter and repeater, SC connector, single-mode, 10 km	-	1	-	2 (single-mode)	10 Km
	EF24-1G-1Fs-SC-20K	Gigabit Ethernet to Fiber converter, SC connector, single-mode, 20 km	-	1	-	1 (single-mode)	20 Km
	EF24-1G-1SFP	Gigabit Ethernet to Fiber converter, SFP slot	-	1	1	1 (SFP slot)	n/a
	EF24-1G-2SFP	Gigabit Ethernet to Fiber converter and repeater, SFP slot	-	1	2	2 (SFP slot)	n/a

Serial to Fiber Media Converters, DIN-Rail Mount, Metal Housing



SKU	Description	RS-232 RS-485 RS-422 TB5	Fiber ports	Rated distance
	SF63-TB-DB-1Fm-SC	Serial-to-Fiber Media Converter, multi-mode, SC connector, 2 km	1 (multi-mode)	2 Km
	SF63-TB-DB-1Fs-SC	Serial-to-Fiber Media Converter, Single-mode, SC connector, 30 km	1 (single-mode)	30 Km
	SF63-TB-DB-1Fm-ST	Serial-to-Fiber Media Converter, multi-mode, ST connector, 2 km	1 (multi-mode)	2 Km
	SF63-TB-DB-1Fs-ST	Serial-to-Fiber Media Converter, Single-mode, ST connector, 30 km	1 (single-mode)	30 Km

Serial Device Servers

ATOP's Serial to Ethernet Device Servers allow easy connection between RS-232/422/485 legacy devices to Ethernet through both wireless or wired connectivity. These devices are specifically designed to allow industrial devices to be directly accessible from the local network or the Internet. Our devices are from entry-level to industrial grade support 1 - 16 serial and are available in field-mount, DIN-rail mount, and rack-mount, making them very powerful platforms for legacy devices integration with modern network infrastructures. Our industrial serial servers adhere to industrial network performance requirements, such as IEC 61850 and EN 50155.



ATOP Serial Device Servers' versions provide programmability with SDKs on Linux-based platforms. Using the supplied Programming guide, it is easy to develop applications for specific applications. [Ask your sales representative for more information](#)

Entry level Serial Device Servers

Specially designed for automation fields, ATOP's Entry-level Serial Device Servers provide 1 or 2-port RS-232/RS-422/RS-485 connectivity. They are suitable for simple and less demanding applications. Protected by rugged metal case with wall or Din Rail mount, these Serial Device Servers are available with a DB9 or TB5 connector with 2kV magnetic isolation. Selected versions are Industrial-EMC certified.



Entry Level Serial Device Server, Field Mount, Metal Housing



SKU	Description	RS-232 RS-485 RS-422 TB5	RS-232 RS-485 RS-422 DB9	10/100 RJ45 Ports	Additional features	
 	SE5201C-DB	1-Port Serial device Server, DB9	-	1	1	-20~70 °C operation
	SE5201C-TB	1-Port Serial device Server, TB5	1	-	1	-20~70 °C operation
	SE5002(DB)	2-Port Serial device Server, DB9	-	2	1	
	SE5002-S5Sis(TB)	2-Port Serial device Server, TB5, 2 kV isolation	2	-	1	2kV Magnetic Isolation

Industrial EMC Serial Server, Field Mount, Metal Housing



SKU	Description	RS-232 RS-485 RS-422 TB5	RS-232 RS-485 RS-422 DB9	10/100 RJ45 Ports	100 SFP slots	Additional features	
	SE5201-DB	1-Port Industrial Serial device Server, D-Sub 9 connector	-	1	1		
	SE5201-TB	1-Port Industrial Serial device Server, 5-Pin Terminal Block	1	-	1		
	SE5202-DB	2-Port Industrial Serial device Server, D-Sub 9 connector	-	2	1	-	
	SE5202-TB	2-Port Industrial Serial device Server, 5-Pin Terminal Block,	2	-	1	-	
	SE5202-SiS	2-Port Industrial Serial device Server, 5-Pin Terminal Block, Isolation	2	-	1	-	2.5kV isolation
	SE5202-SFP-DB	2-Port Industrial Serial device Server, D-Sub 9 connector, SFP	-	2	-	1	
	SE5202-SFP-TB	2-Port Industrial Serial device Server, 5-Pin Terminal Block, SFP	2	-	-	1	
	SE5202-SFP-SiS	2-Port Industrial Serial device Server, 5-Pin Terminal Block, SFP, Isolation	2	-	-	1	2.5kV isolation

Wireless or Cellular Serial Device Servers

Where cabling installation is an issue, ATOP's wireless serial servers provide a rugged, reliable and affordable solid networking solution for Serial and Ethernet conversion, with one or two available ports and terminal block or DB9 connector. Selected versions feature Industrial EMC compatibility, MIMO dual-antenna features and IEEE 802.11 a/b/g/n and 3G/4G/HSPA connectivity.

Industrial Wireless IEEE 802.11 b/g/n Serial Device Server, DIN-Rail



SKU	Description	RS-232 RS-485 RS-422 TB5	RS-232 RS-485 RS-422 DB9	10/100 RJ45 Ports	Additional features	
	SW5501C	Industrial Wireless 802.11 b/g/n Serial device Server with 1-Serial port	(1)	(1)	1	WPS button
	SW5502C-TB	Industrial Wireless 802.11 b/g/n Serial device Server with 2-Serial ports	-	2	1	WPS button
	SW5502C	Industrial Wireless 802.11 b/g/n Serial device Server with 2-Serial ports	2	-	1	WPS button

Industrial Wireless IEEE 802.11 a/b/g/n Serial Device Server, Industrial EMC



SKU	Description	RS-232 RS-485 RS-422 TB5	RS-232 RS-485 RS-422 DB9	10/100 1000 RJ45 Ports	Additional features	
	SW5501	Industrial Wireless 802.11 a/b/g/n Serial device Server with 1-Serial port	-	1	1	
	SW5501-TB	Industrial Wireless 802.11 a/b/g/n Serial device Server with 1-Serial port	1	-	1	
	SW5501-Sis	Industrial Wireless 802.11 a/b/g/n Serial device Server with 1-Serial port and 2kV isolation	1	-	1	2 kV isolation
	SW5502	Industrial Wireless 802.11 a/b/g/n Serial device Server with 2-Serial port	-	2	1	
	SW5502-TB	Industrial Wireless 802.11 a/b/g/n Serial device Server with 2-Serial port	2	-	1	
	SW5502-Sis	Industrial Wireless 802.11 a/b/g/n Serial device Server with 2-Serial port and 2kV isolation	2	-	1	2 kV isolation

Industrial Wi-Fi Mesh Serial Device Server, Industrial EMC, DIN-Rail, Metal Housing

NEW
Coming soon!



SKU	Description	10/100 RJ45	Wireless Modules	Serial Ports	Additional features	
	SW5901	1-Port Industrial 802.11 a/b/g/n WiFi-Mesh Serial Server, 2x 10/100 RJ45 Ports, DB9+TB5 combo	2	1 Wi-Mesh	1x DB9/TB5 combo	WPS button
	SW5901-Sis	1-Port Industrial 802.11 a/b/g/n WiFi-Mesh Serial Server, 2x 10/100 RJ45, DB9+TB5 combo, 3kV isol.	2	1 Wi-Mesh	1x DB9/TB5 combo	WPS button, 3kV isolation
	SW5901-PoE	1-Port Industrial 802.11 a/b/g/n WiFi-Mesh Serial Server, 2x 10/100 RJ45 Ports, DB9+TB5 combo	2	1 Wi-Mesh	1x DB9/TB5 combo	WPS button, PoE PD
	SW5901-PoE-Sis	1-Port Industrial 802.11 a/b/g/n WiFi-Mesh Serial Server, 2x RJ45, DB9+TB5 combo, 3kV isol, PoE PD	2	1 Wi-Mesh	1x DB9/TB5 combo	WPS button, PoE PD, 3kV isolation
	SW5902-DB or -TB	2-Port Industrial 802.11 a/b/g/n WiFi-Mesh Serial Server, 2x 10/100 RJ45 Ports, DB9 or TB5	2	1 Wi-Mesh	2x DB9 or TB5	WPS button
	SW5902-Sis	2-Port Industrial 802.11 a/b/g/n WiFi-Mesh Serial Server, 2x 10/100 RJ45 Ports, Term. Block, 3kV isol.	2	1 Wi-Mesh	2x TB5	WPS button, 3kV isolation
	SW5902-PoE-DB or -TB	2-Port Industrial 802.11 a/b/g/n WiFi-Mesh Serial Server, 2x 10/100 RJ45 Ports, DB9 or TB5, PoE PD	2	1 Wi-Mesh	2x DB9 or TB5	WPS button, PoE PD
	SW5902-PoE-Sis	2-Port Industrial 802.11 a/b/g/n WiFi-Mesh Serial Server, 2x 10/100 RJ45 Ports, TB, 3kV isol., PoE PD	2	1 Wi-Mesh	2x TB5	WPS button, PoE PD, 3kV isolation

Industrial Cellular 3G/4G LTE Serial Gateway and VPN router, Digital I/O, DIN-Rail mount

NEW features!



SKU	2G/3G/HSPA	4G LTE	RS-232 RS-485 TB14	RS-232 RS-485 DB9	10/100/1000 RJ45 Ports	Digital Inputs/ Digital Outputs	Additional features	
	SE5901B-D3G	X	-	1	1	-		
	SE5901B-IO-D3G	X	1+1*	-	1	2/2		
	SE5901B-IO-D3G-GPS	X	1+1*	-	1	2/2	GPS	
	SE5901B-4G	X		-	1	1	-	
	SE5901B-IO-4G	X	X	1+1*	-	1	2/2	
	SE5901B-IO-4G-GPS	X	X	1+1*	-	1	2/2	GPS
	SE5901B-4G-B	X	X	-	1	1	-	Battery function
	SE5901B-IO-4G-B	X	X	1+1*	-	1	2/2	Battery function
	SE5901B-IO-4G-GPS-B	X		1+1*	-	1	2/2	GPS / Battery function

* one TB14 sw-selectable RS-485; RS-232 and one RS-232.

** new features include Port-Forwarding, NAT, IPsec, OpenVPN, PPTP and SMS management

Advanced Serial Device Servers

ATOP's advanced serial device servers satisfy rigorous industrial automation requirements. They feature a wider operational temperature range – from -20°C to +70°C, with selected versions featuring a range of -40°C to +85°C. In addition, they feature advanced EMC capabilities and faster CPUs to provide advanced features and faster processing times. They are more suitable for challenging environments. Selected advanced units provide additional gigabit connectivity and Power over Ethernet (PoE), so that ordinary power supplies don't need to be relied on.

Advanced Industrial Serial Device Servers, DIN-Rail Mount

NEW features!



SKU	Description	RS232-RS485-RS422 TB5	RS-232 RS-485 RS-422 DB9	10/100 RJ45 Ports	Additional features	
	SE5901-DB	Industrial 2-Ethernet 1- Serial Device Server (DB)	-	1	2	
	SE5901-TB	Industrial 2-Ethernet 1- Serial Device Server (TB)	1	-	2	
	SE5901-DB-PoE	Industrial 2-Ethernet 1- Serial Device Server (DB), can be PoE Powered	-	1	2	PoE powered
	SE5901-TB-PoE	Industrial 2-Ethernet 1- Serial Device Server (TB), can be PoE Powered	1	-	2	PoE powered

* new features include IPsec, OpenVPN, PPTP and RSTP redundancy.

Advanced Industrial Serial Device Servers, DIN-Rail Mount

NEW features!



SKU	Description	RS-232 RS-485 RS-422 TB5	RS-232 RS-485 RS-422 DB9	10/100 RJ45 Ports	1000 Gigabit	Additional features
	SE5904D-DB	-	4	2	-	
	SE5904D-TB	4	-	2	-	
	SE5904D-SIS	4	-	2	-	3kV isolation
	SE5904D-DB-PoE	-	4	2	-	PoE-powered
	SE5904D-TB-PoE	4	-	2	-	PoE-powered
	SE5904D-Sis-PoE	4	-	2	-	PoE-powered, 3kV isolation
	SE5904D-G-DB-SFP	-	4	-	2	
	SE5904D-G-TB-SFP	4	-	-	2	
	SE5904D-G-Sis-SFP	4	-	-	2	3 kV isolation

* new features include IPsec, OpenVPN, PPTP and RSTP redundancy.

Advanced Serial Device Servers, Rack-Mount

NEW features!



SKU	Description	RS-232 RS-485 RS-422 RJ45	RS-232 RJ45	10/100 RJ45 Ports	Additional features
	SE5908-DC	8	-	2	
	SE5908-SIS-DC	-	8	2	2.5 kV isolation
	SE5916-DC	16	-	2	
	SE5916-SIS-DC	-	8	2	2.5 kV isolation
	SE5908-EU	8	-	2	
	SE5908-US	8	-	2	
	SE5916-EU	16	-	2	
	SE5916-US	16	-	2	
	SE5908-Sis-EU	-	8	2	2.5 kV isolation
	SE5908-Sis-US	-	8	2	2.5 kV isolation
	SE5916-Sis-EU	-	16	2	2.5 kV isolation
	SE5916-Sis-US	-	16	2	2.5 kV isolation

* new features include IPsec, OpenVPN, PPTP and RSTP redundancy.

IEC61850-3 – Substation-specific Serial Device Servers

ATOP's Substation serial servers feature: 8 to 16 x Serial ports (RS-232/RS-485/RS-422) with or without isolation; 6 x Ethernet ports with RJ45 or SFP connector; Wide -40°C to +85°C temperature range and are enclosed in a rugged IP30-rated rack-mount housing. Available in two power options: redundant 24–48VDC input or redundant 100–330VDC / 100–240VAC, with additional relay outputs are available.

IEC61850-3 Certified Substation Serial Device Server

NEW features!        

SKU	Description	RS-232 RS-485 RS-422 TB5	RS-232 RS-485 RS-422 DB9	10/100 RJ45 Ports	100 Mbps SFP Slots	Additional features
 SE5908A **	Industrial IEC61850-3 8-Port Serial Device Server, DB9(M), RS-232/422/485, RJ45	-	8	6	-	
SE5908A-TB **	Industrial IEC61850-3 8-Port Serial Device Server, TB5, RS-232/422/485, RJ45	8	-	6	-	
SE5908A-SIS **	Industrial IEC61850-3 8-Port Serial Device Server, TB5, RS-422/485, RJ45, 3kV Isolation	8 *	-	6	-	3kV isolation
SE5908A-6SFP **	Industrial 2-Ethernet - 4-Serial device Server (TB)	-	8	-	6	
SE5908A-6SFP-TB **	Industrial 2-Ethernet - 4-Serial device Server (TB), with 3kV Serial Isolation	8	-	-	6	
SE5908A-6SFP-SIS **	Industrial 2-Ethernet - 4-Serial device Server (DB), PoE	8 *	-	-	6	3kV isolation
SE5916A **	Industrial IEC61850-3 16-Port Serial Device Server, DB9(M), RS-232/422/485, RJ45	-	16	6	-	
SE5916A-TB **	Industrial IEC61850-3 16-Port Serial Device Server, DB9(M), RS-232/422/485, RJ45	16	-	6	-	
SE5916A-SIS **	Industrial IEC61850-3 16-Port Serial Device Server, DB9(M), RS-232/422/485, RJ45	16 *	-	6	-	3kV isolation
SE5916A-6SFP **	Industrial 2-Ethernet - 4-Serial device Server (TB)	-	16	-	6	
SE5916A-6SFP-TB **	Industrial 2-Ethernet - 4-Serial device Server (TB), with 3kV Serial Isolation	16	-	-	6	
SE5916A-6SFP-SIS **	Industrial 2-Ethernet - 4-Serial device Server (TB), with 3kV Serial Isolation	16 *	-	-	6	3kV isolation

* The SIS (3kV isolated) version supports 8 or 16 RS-422/ RS-485
 ** All versions are available in 24~48VDC or 100~370VDC/100~240VAC power input (add -HV to model name)
 *** new features include IPsec, OpenVPN, PPTP and RSTP redundancy.

EN50155 – Railway specific Serial Device Servers

ATOP's railway serial servers support two serial connectivity ports (RS-232/RS-485/RS-422) and one Ethernet port with M12 connectors and are enclosed in a waterproof IP68 housing, provide 15KV ESD protection on serial signals to protect costly and sensitive equipment.

EN50155 Railway Waterproof Serial Device Server

Pic	SKU	Description	RS232- RS485- RS422 M12	10/100 M12 Ports	Additional features
	SE8502-M12	Waterproof Ethernet to Serial device Server, EN 50155 certified	2	1	
	SE8502-SIS-M12	Waterproof Ethernet to Serial device Server, EN 50155 certified, 2 kV isolation.	2	1	2 kV isolation



TAIWAN HEAD OFFICE

2F, No. 148, Sec. 1, Tung-Hsing Rd,
30261 Chupei City. Hsinchu County
Taiwan, R.O.C.
Tel: +888-3-550-8137
Fax: +886-3-550-8131
E-mail: sales@atop.com.tw

ATOP INDIA OFFICE

Abhishek Srivastava
Head of India Sales
Atech Solutions(P) Ltd.
No. 311, 6th Main Rd, Indiranagar
Bangalore, 560038. India
Tel: +91-80-4920-6363
E-mail: Abhishek.S@atop.in

ATOP GERMANY OFFICE

Matteo Tabarelli de Fatis
Senior Vice President (Operations)
Auwaldstraße 8, 96231
Bad Staffelstein, Germany
Tel: +49-172-8181-556
E-mail: Matteo.Tabarelli@atop.com.tw

ATOP WESTERN EUROPE & UK

Prashant Mishra
Head of Western Europe Sales
Atech Solutions(P) Ltd.
No. 311, 6th Main Rd, Indiranagar
Bangalore, 560038. India
E-mail: Prashant.m@atop.in

ATOP EAST EUROPE, EMEA

EMEA: Bhaskar Kailas (BK)
Vice President (Business Development)
Atech Solutions(P) Ltd.
No. 311, 6th Main Rd, Indiranagar
Bangalore, 560038. India
Tel: +91-988-0788-559
E-mail: Bhaskar.k@atop.in

ATOP AMERICAs OFFICE

Venke Char
Sr. Vice President & Head of Business
11811 North Tatum Blvd, Suite 3031
Phoenix, AZ 85028, United States
Tel: +1-602-953-7669
E-mail: venke@atop.in

ATOP CHINA BRANCH

3F. 75. No. 1086 Building,
Qingzhou North Road
Shanghai, China
Tel: +86-21-64956231

ATOP INDONESIA BRANCH

PT.Atop Indonesia Technologies
Wisma Slipi, Jl. Let.Jend. S. Parman Kav. 12,
Unit : 308, Jakarta Barat 11480
Indonesia
Tel. (+62-21)5326171
Fax. (+62-21)5326172
E-mail : jopsonli@atop.com.tw

