

DETAIL A
KEY SLOTS #2 & #4 SHOWN
SCALE 2:1

www.fciconnect.com			surface - ✓	tolerance std ---	projection	MM
			TOLERANCES UNLESS OTHERWISE SPECIFIED			Scale 1:1
Dr	STU STONER	2008-02-05	ANGULAR	0.X	±0.3	size A3
Eng	J SHUEY	2008-02-05		LINEAR	0.XX	
Chr	J SHUEY	2008-02-05	0° ±2°	0.XXX	±0.050	ECN V10-0364
Appr	J SHUEY	2008-02-05	Product family		C&A	Spec ref ---
			FINAL ASSEMBLY - ALTERNATE CABLE Mini SAS 2.0/SATA (CRKT)		dwg no 10084749	Rev. E
			catalog no		CUSTOMER	sheet 1 of 6

rev	ecn no	dr	date
A	V08-0308	DAI	2008-09-08
B	V08-0491	DAI	2008-11-11
C	N09-0146	RE	2009-05-20
D	V10-0243	DAI	2010-05-26
E	V10-0364	DAI	2010-09-29

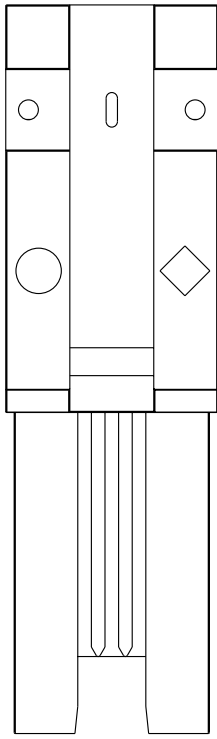

KEY SLOT 2, 4 & 6
 ○ ◇ UNVERSIAL PORT

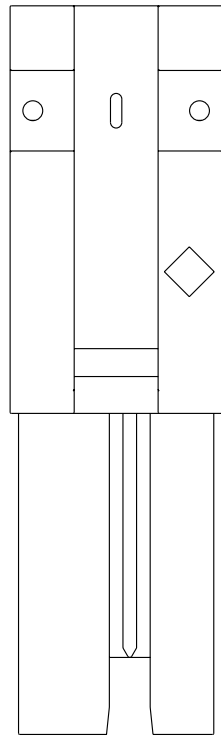

KEY SLOT 2 & 4
 ◇ OUT PORT

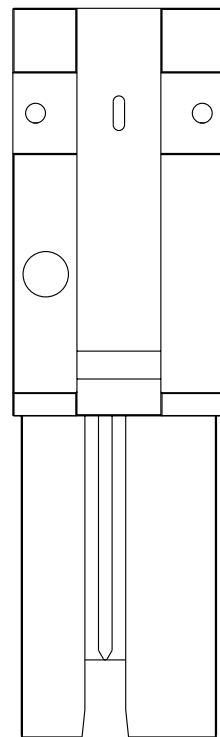

KEY SLOT 4 & 6
 ○ IN PORT

MINI SAS 2.0

PRODUCT NUMBER SEE NOTE 4	DESCRIPTION	GAUGE	"DIM L" LENGTH	END P1 KEY SLOT	END P2 KEY SLOT	IDENTIFIER
10084749-M060002LF	X4 SAS CABLE ASSEMBLY	24 AWG	6M	4, 6	4, 6	SUBTRACTIVE ROUTING (IN PORT), SAS
10084749-N040002LF	X4 SAS CABLE ASSEMBLY	26 AWG	4M	4, 6	4, 6	
10084749-N050002LF	X4 SAS CABLE ASSEMBLY	26 AWG	5M	4, 6	4, 6	
10084749-P010002LF	X4 SAS CABLE ASSEMBLY	28 AWG	1M	4, 6	4, 6	
10084749-P020002LF	X4 SAS CABLE ASSEMBLY	28 AWG	2M	4, 6	4, 6	
10084749-P030002LF	X4 SAS CABLE ASSEMBLY	28 AWG	3M	4, 6	4, 6	
10084749-M060003LF	X4 SAS CABLE ASSEMBLY	24 AWG	6M	2, 4, 6	2, 4, 6	UNIVERSAL KEY, SAS
10084749-N040003LF	X4 SAS CABLE ASSEMBLY	26 AWG	4M	2, 4, 6	2, 4, 6	
10084749-N050003LF	X4 SAS CABLE ASSEMBLY	26 AWG	5M	2, 4, 6	2, 4, 6	
10084749-P010003LF	X4 SAS CABLE ASSEMBLY	28 AWG	1M	2, 4, 6	2, 4, 6	
10084749-P015003LF	X4 SAS CABLE ASSEMBLY	28 AWG	1.5M	2, 4, 6	2, 4, 6	
10084749-P020003LF	X4 SAS CABLE ASSEMBLY	28 AWG	2M	2, 4, 6	2, 4, 6	
10084749-P025003LF	X4 SAS CABLE ASSEMBLY	28 AWG	2.5M	2, 4, 6	2, 4, 6	SAS, TABLE ROUTING (OUT PORT), TO SUBTRACTIVE ROUTING (IN PORT)
10084749-P030003LF	X4 SAS CABLE ASSEMBLY	28 AWG	3M	2, 4, 6	2, 4, 6	
10084749-M060006LF	X4 SAS CABLE ASSEMBLY	24 AWG	6M	2, 4	4, 6	
△E 10084749-N010006LF	X4 SAS CABLE ASSEMBLY	26 AWG	1M	2, 4	4, 6	
△E 10084749-N030006LF	X4 SAS CABLE ASSEMBLY	26 AWG	3M	2, 4	4, 6	
10084749-N040006LF	X4 SAS CABLE ASSEMBLY	26 AWG	4M	2, 4	4, 6	
10084749-N050006LF	X4 SAS CABLE ASSEMBLY	26 AWG	5M	2, 4	4, 6	
10084749-P010006LF	X4 SAS CABLE ASSEMBLY	28 AWG	1M	2, 4	4, 6	
10084749-P020006LF	X4 SAS CABLE ASSEMBLY	28 AWG	2M	2, 4	4, 6	
10084749-P030006LF	X4 SAS CABLE ASSEMBLY	28 AWG	3M	2, 4	4, 6	

MINI SAS 2.0 KEYING OPTIONS

	Title FINAL ASSEMBLY - ALTERNATE CABLE Mini SAS 2.0/SATA (CRKT)	dwg no 10084749	Rev. E
	catalog no -	CUSTOMER	sheet 2 of 6

SATA

PRODUCT NUMBER SEE NOTE 4	DESCRIPTION	GAUGE	"DIM L" LENGTH	END P1 KEY SLOT	END P2 KEY SLOT	IDENTIFIER
10084749-M060004LF	X4 SATA CABLE ASSEMBLY	24 AWG	6M	1,4	1,4	X CABLE, SATA
10084749-N020004LF	X4 SATA CABLE ASSEMBLY	26 AWG	2M	1,4	1,4	
10084749-N040004LF	X4 SATA CABLE ASSEMBLY	26 AWG	4M	1,4	1,4	
10084749-N050004LF	X4 SATA CABLE ASSEMBLY	26 AWG	5M	1,4	1,4	
10084749-P010004LF	X4 SATA CABLE ASSEMBLY	28 AWG	1M	1,4	1,4	
10084749-P030004LF	X4 SATA CABLE ASSEMBLY	28 AWG	3M	1,4	1,4	
10084749-M060005LF	X4 SATA CABLE ASSEMBLY	24 AWG	6M	7	7	M CABLE, SATA
10084749-N020005LF	X4 SATA CABLE ASSEMBLY	26 AWG	2M	7	7	
10084749-N040005LF	X4 SATA CABLE ASSEMBLY	26 AWG	4M	7	7	
10084749-N050005LF	X4 SATA CABLE ASSEMBLY	26 AWG	5M	7	7	
10084749-P010005LF	X4 SATA CABLE ASSEMBLY	28 AWG	1M	7	7	
10084749-P030005LF	X4 SATA CABLE ASSEMBLY	28 AWG	3M	7	7	

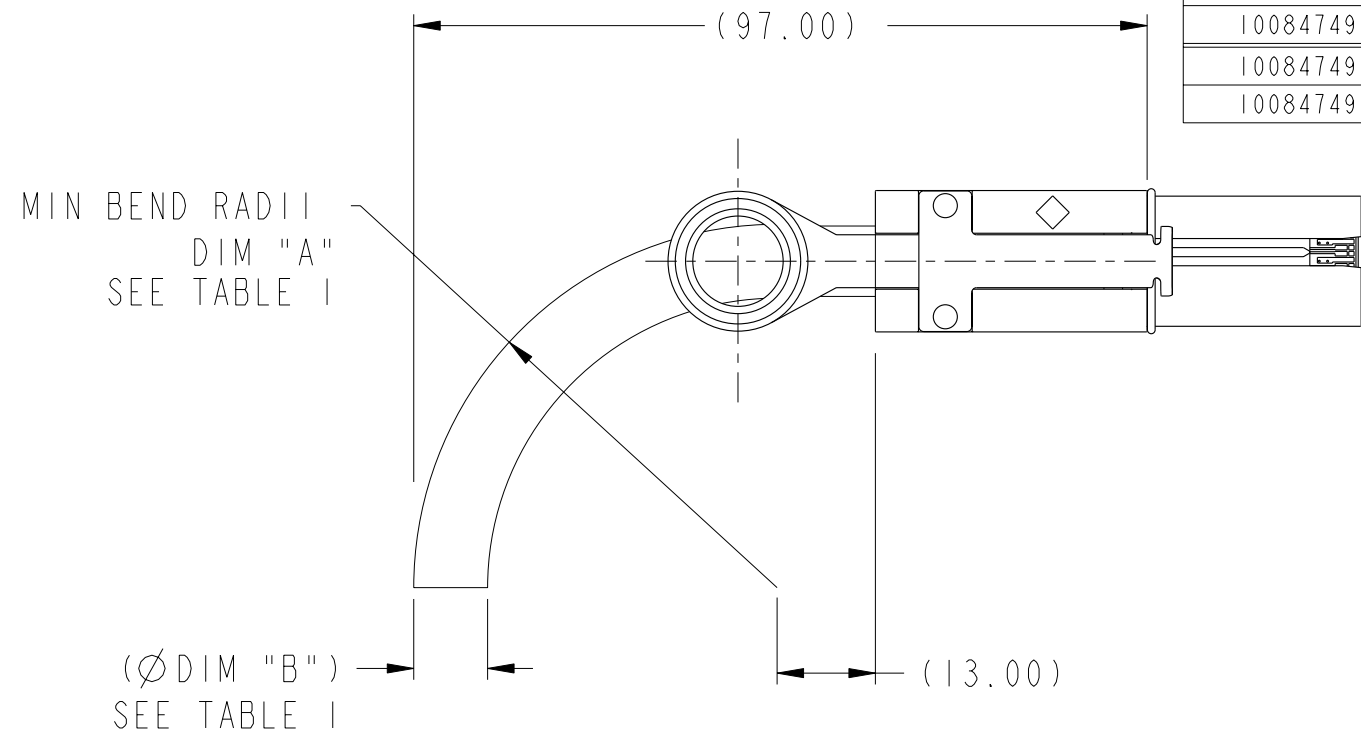

**BEND RADIUS
(24 AWG SHOWN)**

CABLE	DIM "A"	DIM "B"
24 AWG	(R46.9)	(Ø 9.5mm)
26 AWG	(R41.7)	(Ø 8.3mm)
28 AWG	(R37.7)	(Ø 7.6mm)

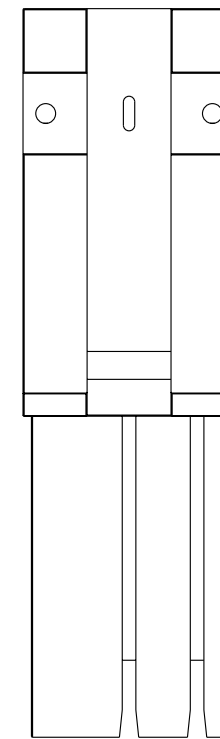

KEY SLOT 1 & 4
X CABLE, SATA

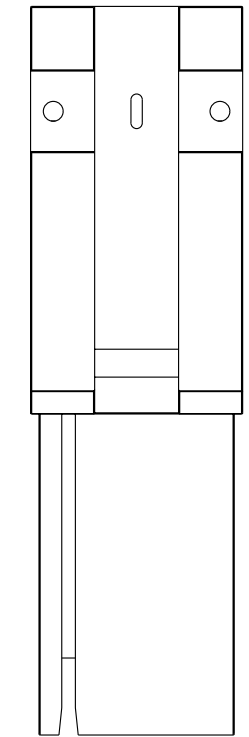

KEY SLOT 7
M CABLE, SATA

SATA KEYING OPTIONS

	Title FINAL ASSEMBLY - ALTERNATE CABLE Mini SAS 2.0/SATA (CRKT)	dwg no 10084749	Rev. E
	catalog no -	CUSTOMER	sheet 3 of 6

1

2

3

4

A

B

C

D

A

B

C

D

WIRING LIST SEE NOTE 7

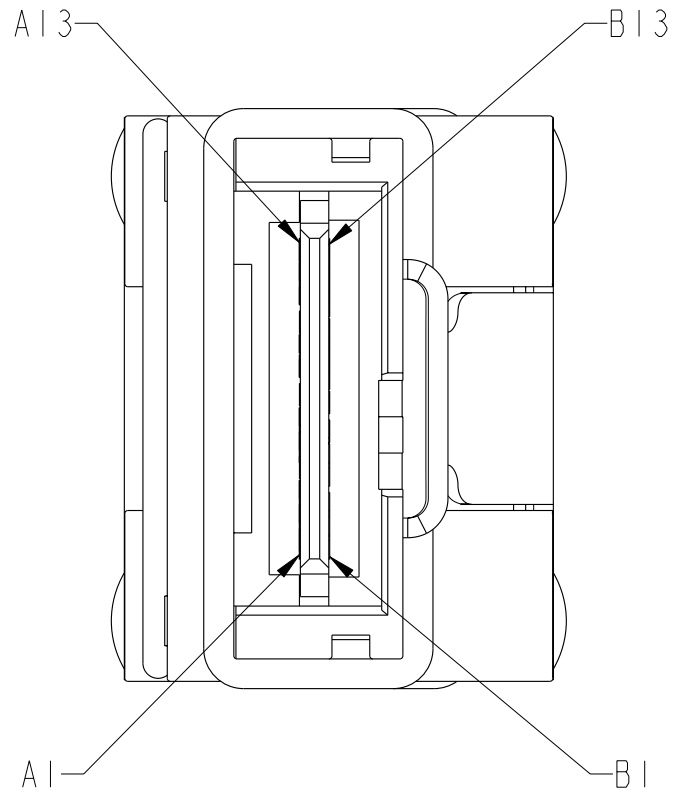

	GND	A1	—	B1	GND
	Rx 0+	A2	←	B2	Tx 0+
	Rx 0-	A3	←	B3	Tx 0-
	GND	A4	—	B4	GND
	Rx 1+	A5	←	B5	Tx 1+
	Rx 1-	A6	←	B6	Tx 1-
	GND	A7	—	B7	GND
	Rx 2+	A8	←	B8	Tx 2+
	Rx 2-	A9	←	B9	Tx 2-
	GND	A10	—	B10	GND
	Rx 3+	A11	←	B11	Tx 3+
	Rx 3-	A12	←	B12	Tx 3-
	GND	A13	—	B13	GND
P1	GND	B1	—	A1	GND
	Tx 0+	B2	→	A2	Rx 0+
	Tx 0-	B3	→	A3	Rx 0-
	GND	B4	—	A4	GND
	Tx 1+	B5	→	A5	Rx 1+
	Tx 1-	B6	→	A6	Rx 1-
	GND	B7	—	A7	GND
	Tx 2+	B8	→	A8	Rx 2+
	Tx 2-	B9	→	A9	Rx 2-
	GND	B10	—	A10	GND
	Tx 3+	B11	→	A11	Rx 3+
	Tx 3-	B12	→	A12	Rx 3-
	GND	B13	—	A13	GND
					P2



Copyright FCI.

	Title FINAL ASSEMBLY - ALTERNATE CABLE Mini SAS 2.0/SATA (CRKT)	dwg no 10084749	Rev. E
	catalog no -	CUSTOMER	sheet 4 of 6

2

3

PDM: Rev:E

STATUS: Released

Printed: Dec 23, 2010

NOTES:

- ① - MATERIAL:
BACKSHELLS: ZINC DIECAST
PULL TAB: MOLDED THERMOPLASTIC
LATCH: STAINLESS STEEL
JET MELT: POLYAMIDE POLYMER
- 2 - ELECTRICAL PERFORMANCE PER CURRENT REVISION OF SERIAL ATA, T10/I760-D (SAS-2 REQUIREMENTS).
- ③ - THIS PRODUCT MEETS THE RESTRICTION OF HAZARDOUS SUBSTANCES IN ELECTRICAL AND ELECTRONIC EQUIPMENT (RoHS) DIRECTIVE (2002/95/EC)

4 - PART NUMBER DESCRIPTION

10084749 - X XX XX XX LF

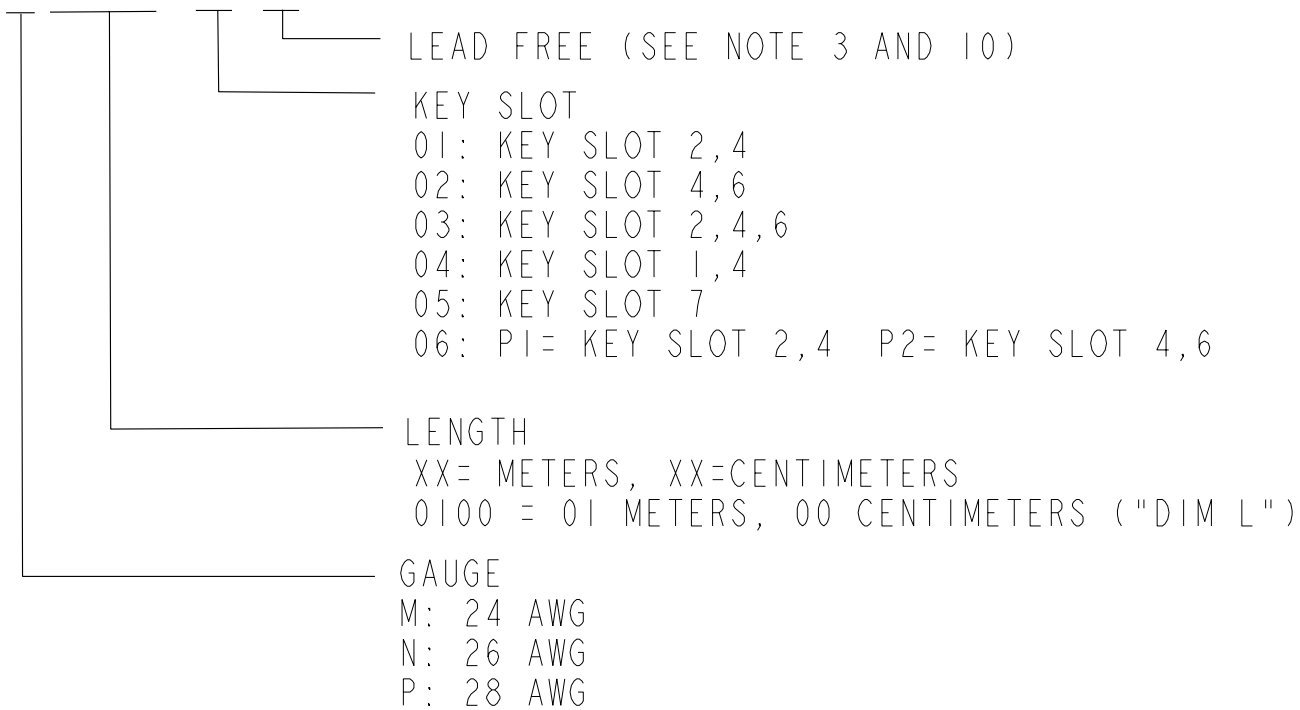

- ⑤ - UNLESS OTHERWISE SPECIFIED ASSEMBLED LENGTH TOLERANCE IS TO BE:
< 1 METER = ±25.0mm
> 1 METER TO 6 METERS = ± 2% OF "DIM L"

- ⑥ - UNLESS OTHERWISE SPECIFIED LABEL POSITION IS TO BE 50mm FROM REAR OF CONNECTOR.
LABEL DETAILS:
MANUFACTURER CODE OR NAME
CUSTOMER P/N OR FCI P/N
REVISION
DATE CODE (WW/YY FORMAT) - SERIAL NUMBER
COUNTRY ORIGIN

EXAMPLE SHOWN BELOW:

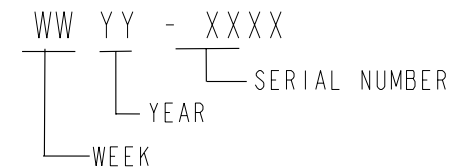

FONT SHALL BE CLEARLY VISIBLE AND BLACK IN COLOR.



Copyright FCI.

	title	FINAL ASSEMBLY - ALTERNATE CABLE	Rev.
	catalog no	10084749	E
	dwg no	CUSTOMER	sheet 5 of 6

NOTES CONTINUED:

- ⑦ - ALL CABLE ASSEMBLIES SHALL BE 100% TESTED FOR CONTINUITY AS DEFINED IN WIRING LIST.
- 8 - UNLESS OTHERWISE SPECIFIED ALL CABLE ASSEMBLIES SHALL BE 100% HI-POT TESTED BY APPLYING 300V DC FOR A MINIMUM OF 10ms, UNLESS ACTIVE COMPONENTS ARE USED IN THIS ASSEMBLY.
- 9 - OTHER TESTING PERFORMED AS REQUIRED BY PRODUCT SPECIFICATION: GS-12-548.
- ⑩ - PACKAGING OF LEAD FREE PRODUCTS MEETS LABELING AND PACKAGING PER SPECIFICATION GS-14-920. PACKAGE CABLE ASSEMBLIES PER GS-14-1272.
- ⑪. THIS DIMENSION IS A FINISHED PRODUCT LENGTH.



Copyright FCI.

	title	FINAL ASSEMBLY - ALTERNATE CABLE	dwg no	10084749	Rev.	
		Mini SAS 2.0/SATA (CRKT)			E	
	catalog no		-	CUSTOMER	sheet 6 of 6	