

To put the finishing touch on your application, we offer an extensive selection of useful accessories to build and install DIN Rail terminal block assemblies and to facilitate factory and field wiring.

Accessories include end stops, end plates and partitions. Also offered are DIN Rails, ferrules, jumpers and more. From design to commissioning and operation, Altech accessories help you do the job better.

We've tried to make the selection of accessories as easy as possible. The most common accessories are listed together with their ordering information on each terminal block page in this catalog.

# Terminal Block Accessories

## MOUNTING

DIN Mounting Rails are internationally standardized and available in 35mm, 32mm and 15mm sizes, with or without perforations. These also accommodate a wide variety of control components such as circuit breakers, timers, motor starters, relays, switches, etc. The 15mm rail with miniature blocks is used when space is at a premium.

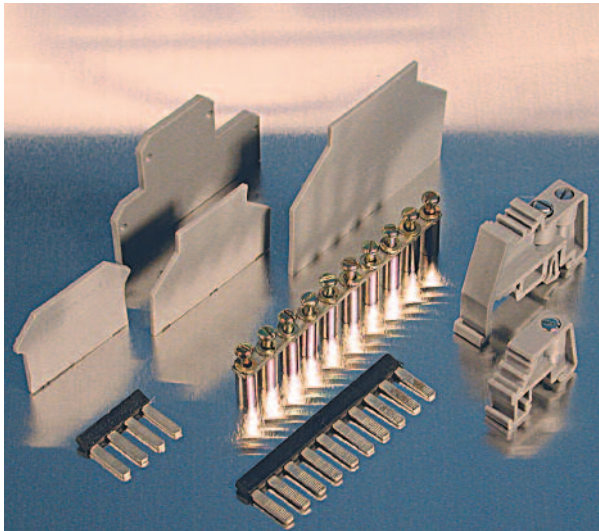
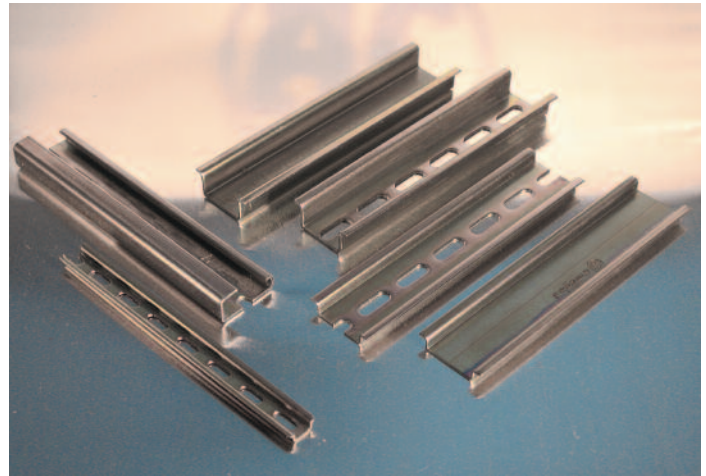

## ACCESORIES

Altech accessories add the finishing touches to your terminal block assemblies. End Stops prevent terminal blocks or other components and devices from moving laterally on the rail.

End Plates close off the last terminal in a series, a vital function, since sectional terminal blocks are supplied with one side open. Isolation partitions provide visual separation of terminal groups, as well as electrical isolation between terminals of different potentials.

## INTERCONNECTION

In addition, Altech offers a wide choice of both Internal and External Jumpers to minimize wiring time and reduce installation cost. Available in standard 2, 3, 4 and 10 pole configurations, or custom multipole jumpers. Our internal jumpers screw directly into terminal block busbars.

External jumpers are available in straight-comb styles. They may be used for terminal blocks without internal jumpering provisions or in combination with internal jumpers.

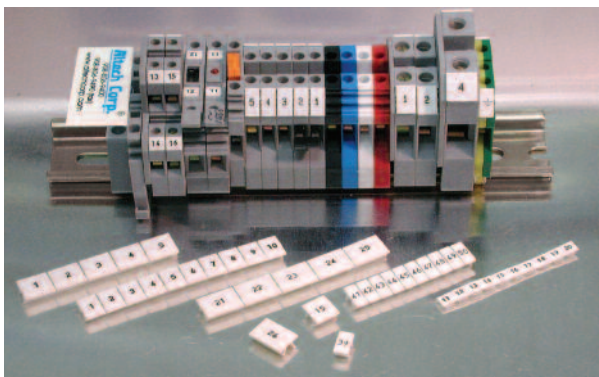
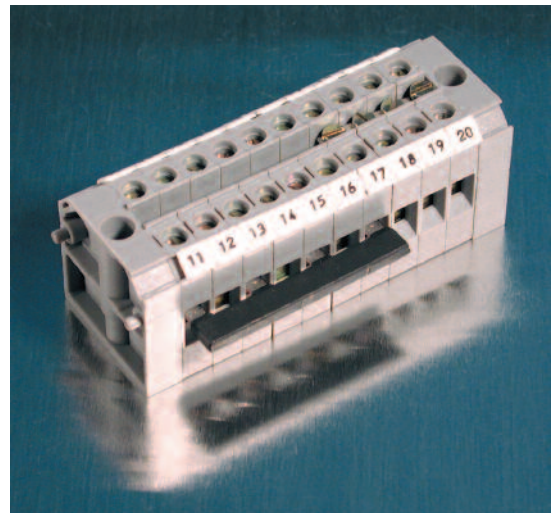

## MARKING TAGS

Marking Tags make DIN Rail assemblies easier to wire and facilitate troubleshooting. Altech's extensive terminal block marking system includes standard or custom printed push on tags in a variety of sizes for circuit identification.

# Altech TERMINAL BLOCK ACCESORIES

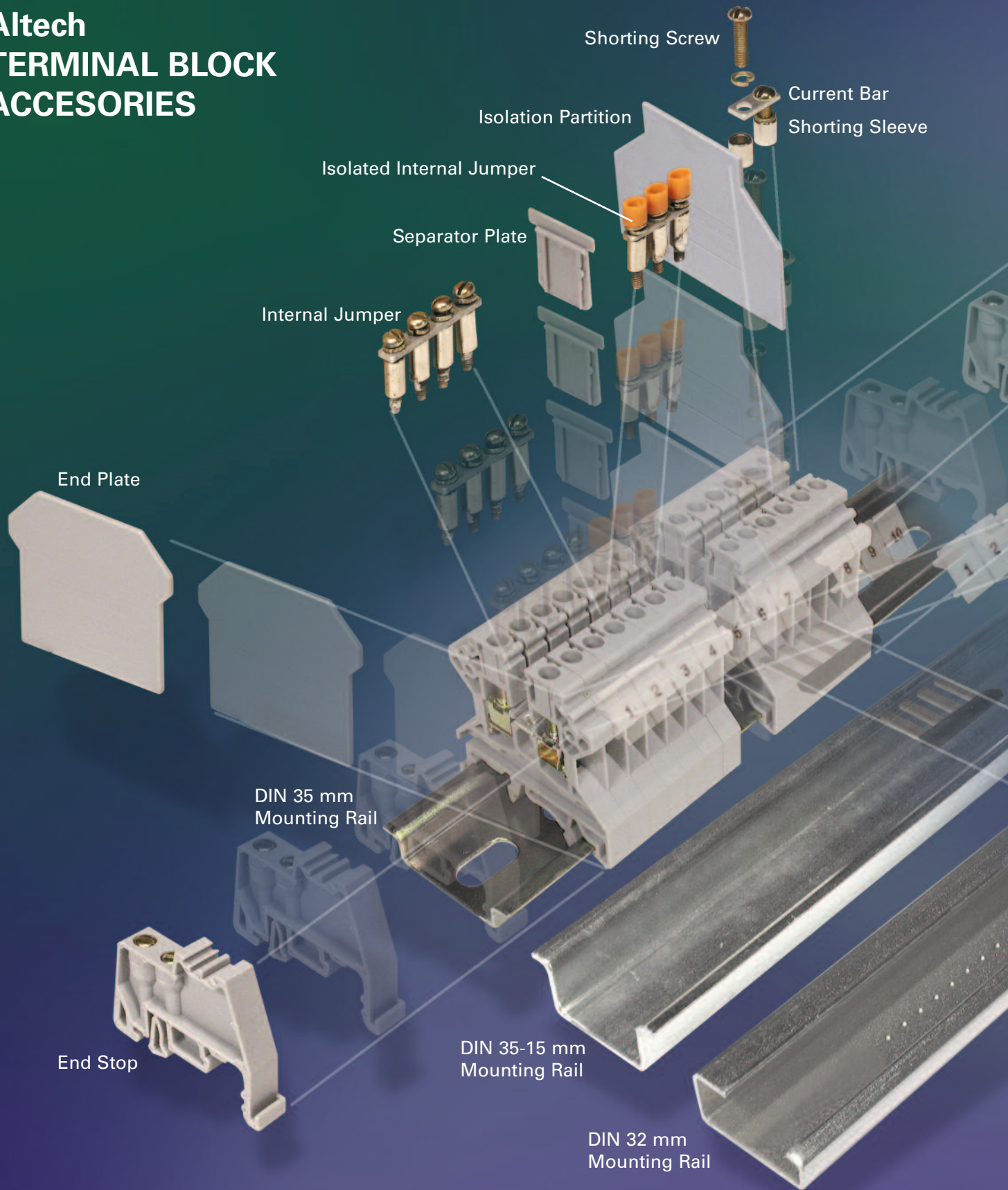

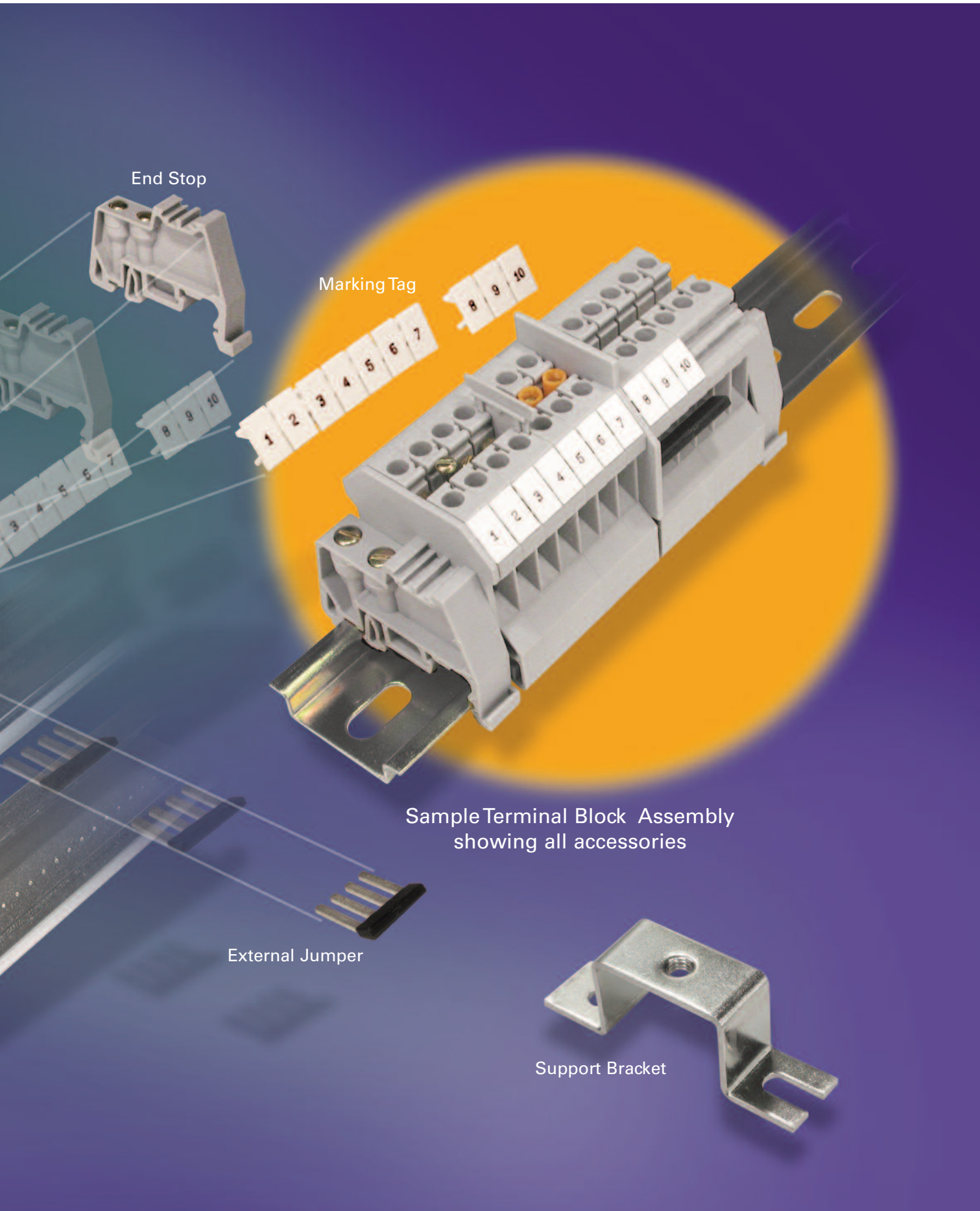

End Stop

Marking Tag

Sample Terminal Block Assembly showing all accessories

External Jumper

Support Bracket

# Terminal Block Accessories

## DIN Mounting Rails

Altech DIN Rails comply with DIN 50045, 50022 and 50035 Standards. DIN Rails have been accepted throughout the world, allowing the designer to mount a wide variety of control components, devices, terminal blocks, etc. on the same rail. The use of DIN Rails enhances design capabilities, saves space and reduces labor.

Standard rails are made of steel with zinc plating and chromate passivation and are available in various configurations.

DIN Rails are available in 35mm (7.5 and 15mm deep), 32mm and 15mm widths and are supplied in 1 m (3'3") and 2 m (6'6") lengths. Upon request they can be cut to custom lengths and punched with holes or perforations.

- 35mm, 32mm, 15mm
- Perforated or unperforated
- Rail material is steel with electrolytic zinc plating

### DIN35

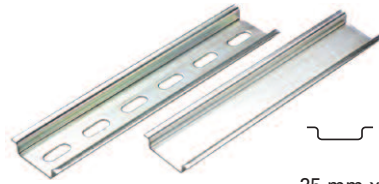

35 mm x  
7.5 mm deep

Type	Cat. No.	Length	Std. Pk.
Perforated Steel	2511120	2m	20
	2511120/1M	1m	40
Unperforated Steel	2511110	2m	20
	2511110/1M	1m	40

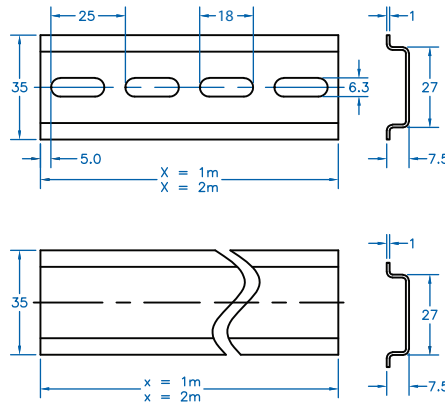

### DIN35

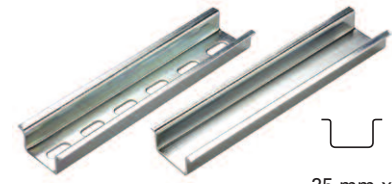

35 mm x  
15 mm deep

Type	Cat. No.	Length	Std. Pk.
Perforated Steel	CA701-15/S-2M	2m	10
	CA701-15/S	1m	20
Unperforated Steel	CA701-15-2M	2m	10
	CA701-15	1m	20

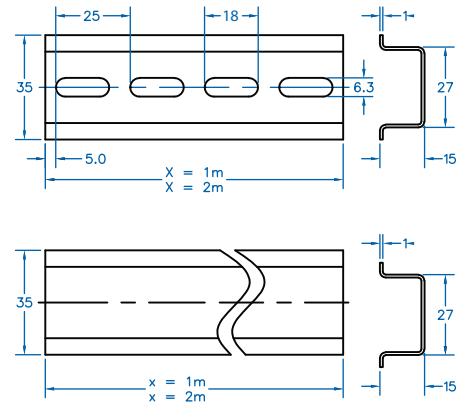

## Support Brackets

Support Brackets elevate DIN Rails away from the panel to facilitate component mounting and to increase wiring access. Angled brackets tilt the rail by 35° to improve visibility. Straight brackets are available in three heights for optimum positioning of the rail.

Brackets mount with 2 screws to any panel or flat surface and have tapped center holes for rail mounting. Bracket material is steel, zinc plated yellow chromated.

### CA603

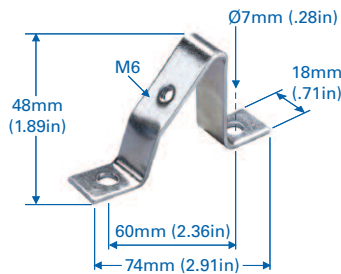

Suitable for all mounting rails

Cat. No.	Std. Pk.
CA603	25

### TSTW

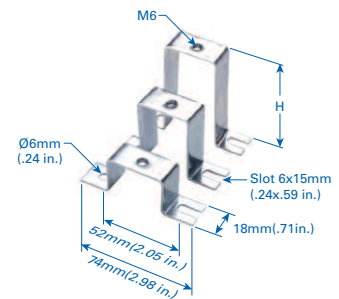

Complete with rail mounting hardware: including one screw & one locknut

Height	Cat. No.	Std. Pk.
1"	CA703	25
2"	CA803	25
3"	CA903	25

**DIN32**

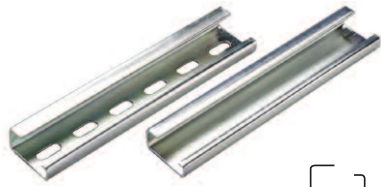

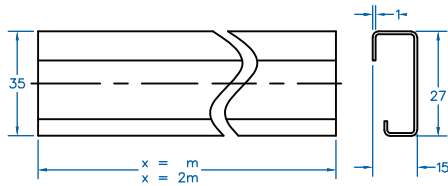
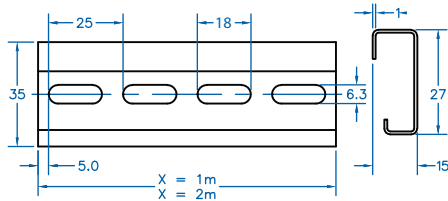

  
35 mm x  
15 mm deep

Type	Cat. No.	Length	Std. Pk.
Perforated Steel	2511160	2m	10
	2511160/1M	1m	20
Unperforated Steel	2511150	2m	10
	2511150/1M	1m	20

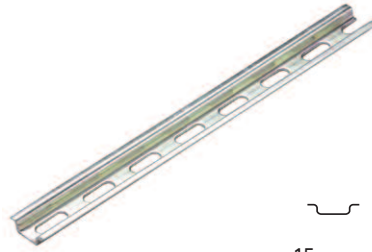

**DIN15**



  
15 mm x  
5.5 mm deep

Type	Cat. No.	Length	Std. Pk.
Perforated Steel	CA601/S	1m	50

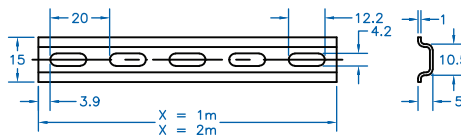

**Mounting Handle**

Mounting handle is used for mounting 10 terminal blocks on a DIN rail, thus saving considerable time. Specially designed pins in the mounting handle grips the terminal blocks when pressed against entry.

**MH2.5**

**MH4**







Cat. No.	Jumper for	Std. Pk.
MH2.5	CTS2.5U-N	1

Cat. No.	Jumper for	Std. Pk.
MH4	CTS4U-N	1

# Terminal Block Accessories

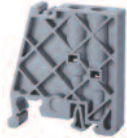
## End Stops

End Stops prevent terminal blocks and other DIN Rail mount components and devices from moving laterally on the rail. They are available in polyamide 6.6 and metal configurations for 35mm, 32mm, and 15mm DIN rails. CA102 and CA202 are large endstops for heavy duty applications. CA103 is a screwless endstop and snaps on to the DIN rail.

CA102		CA202		CA702		CA802		CA602	
									
Material: Polyamide 6.6		Material: Polyamide 6.6		Material: Polyamide 6.6		Material: Polyamide 6.6		Material: Polyamide 6.6	
Dimensions H x L x W: 46 x 50 x 9 mm		Dimensions H x L x W: 44.5 x 50 x 9.5 mm		Dimensions H x L x W: 34 x 44 x 9 mm		Dimensions H x L x W: 32 x 45 x 8 mm		Dimensions H x L x W: 20 x 28 x 8 mm	
Cat. No.	Std. Pk.	Cat. No.	Std. Pk.	Cat. No.	Std. Pk.	Cat. No.	Std. Pk.	Cat. No.	Std. Pk.
CA102	50	CA202	50	CA702	50	CA802	50	CA602	50
Suitable for: 32 and 35 mm DIN Rails		Suitable for: 35 mm DIN Rails		Suitable for: 32 and 35 mm DIN Rails		Suitable for: 35 mm DIN Rails		Suitable for: 15 mm DIN Rails	

## Spacer / Separator



CASP is a DIN Rail mountable spacer generally used for circuit separation.

## DIN Rail Mounting Foot

CMTB-35 is used to assemble components on a DIN rail. Comes with pre-punched holes.

- Support bracket for DIN rail mounting parts
- Hole Qty x dia., 4x4.3mm, 2x5.5mm

CA103		CA302		CA402		CA502	
							
Material: Polyamide		Material: Steel		Material: Steel		Material: Steel	
Dimensions H x L x W: 41 x 35 x 6 mm		Dimensions H x L x W: 27 x 39.5 x 16 mm		Dimensions H x L x W: 27 x 39.5 x 16 mm		Dimensions H x L x W: 25 x 22.5 x 11.5 mm	
Cat. No.	Std. Pk.	Cat. No.	Std. Pk.	Cat. No.	Std. Pk.	Cat. No.	Std. Pk.
CA103	50	CA302	50	CA402	50	CA502	50
Suitable for: 35 mm DIN Rails		Suitable for: 35x7.5mm DIN Rails		Suitable for: 35x15 mm DIN Rails		Suitable for: 32 mm DIN Rails	

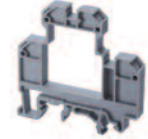
CASP		CMTB-35		CDL4USP	
					
Material: Polyamide 6.6		Material: Polyamide 6.6		Material: Polyamide 6.6	
Dimensions H x L x W: 29 x 43 x 8 mm		Dimensions H x L x W: 18 x 58 x 18 mm		Dimensions H x L x W: 54 x 55.5 x 6 mm	
Cat. No.	Std. Pk.	Cat. No.	Std. Pk.	Cat. No.	Std. Pk.
CASP	50	CMTB-35	50	CDL4USP	50
Suitable for: All DIN Rails		Suitable for: Mounting Foot for 35 mm DIN rails		Suitable for: All DIN Rails	

**Group Identification**

GMH6, GMH7 & GMH8

To be mounted directly on Din Rails (GMH6 & GMH7). A sticker / paper needs to be inserted in the slot which is covered by a transparent plastic sheet.

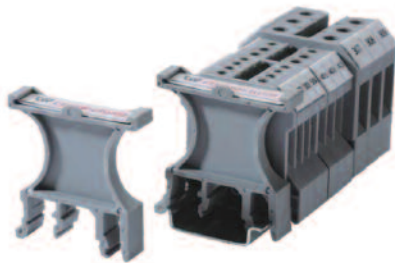

**Mountable on**  
All mounting rails  
**Dimension**  
**GMH6** 46.5(H) x 44.5(W) x 9.5(T) mm



**Mountable on**  
All mounting rails  
**Dimension**  
**GMH7** 46.5(H) x 44.5(W) x 9.5(T) mm

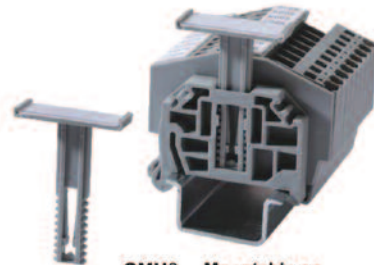

**GMH8** **Mountable on**  
CA103  
**Dimension**  
44 (H) x 30.5(W) x 10(T) mm



Group Marker,  
shown imprinted and  
attached to CA 702.  
Blank and custom  
printing available.  
Cat. No. MTG1

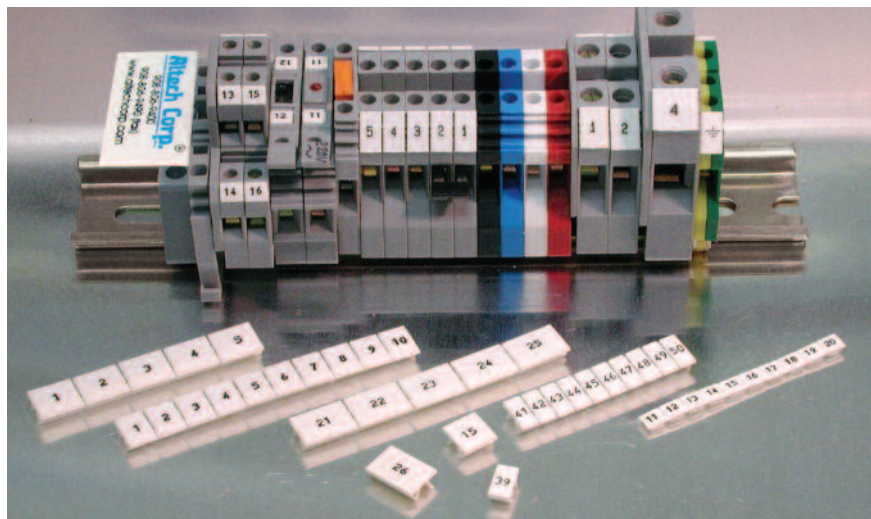



# Terminal Block Accessories

## End Plates

End plates are used to cover the open side of sectional DIN Rail mount terminal blocks. They should be used at the end of an assembly of identical terminal blocks or whenever there is a change in the physical size of the terminal block.

- Material: polyamide 6.6
- Standard color: gray

### END PLATES



Cat. No.	Std. Pk.	Dimensions (H x L x W)	Suitable for:
EP2.5/4UN	50	32 x 39 x 1.5	CTS2.5UN/4UN/CTT2.5UK/T/J/E
EP6/10U	50	31 x 42.5 x 1.5	CTS6U/CTS10U
EP25U	50	40 x 48 x 2	CTS25U
EP35	50	43 x 50 x 1.5	CTS35U
EPCMC1-2	50	35.5 x 46.5 x 2.5	CMC1-2
EPCMC2-2	50	40.5 x 65 x 2.5	CMC2-2
EPCDL4U	50	43 x 55 x 2.4	CDL4U/CDL4U(I.S)/ CDL4U(E) Series
EPODL4U	50	49 x 68 x 5.5	ODL4U/ODL4UA(Front Side)
EP1ODL4U	50	24 x 68 x 3	ODL4U/ODL4UA(Back Side)
EPCTL2.5U	50	55.5 x 84 x 1.5	CTL2.5U/2.5UL/2.5U(I.S)
EPCTL2.5UH	50	55.5 x 61 x 1.5	CTL2.5UH/2.5UH(L)/2.5UH(I.S)D2
EPCMT4	50	22.5 x 27 x 1.5	CMT4/CMT4S/CMT4SU
EPCMB4	50	27 x 27 x 7	CMB4
EPCSFL4U	50	28 x 55.5 x 1.6	CSFL4U/4U(L)/CSDL4U
EPCSFL6U	50	42.5 x 36 x 1.5	CSFL6U/CSDL6U
EPCAFL4U	25	32 x 72 x 1.5	CAFL4U/4UL/4UN
EPDDL4U	25	49 x 87.6 x 3	DDFL4U/4ULR/4U(E)/4U(E)LR
EPCDTTU	50	41 x 63 x 3	CDTTU/CDTTUSH
EPCKT4U	50	30.5 x 46.5 x 2.5	CKT4U
EPCGT4U	50	40.5 x 43 x 1	CGT4U
EPCTC4U	50	34.5 x 47 x 2.5	CTC4U
EPCSTSN5U	50	31 x 50 x 1.5	CSTSN4U/N5U/N6U/B4U/B5U
EPSTH4	50	39.5 x 46 x 1.5	STH4
EPSTH4DT	50	37.5 x 86 x 1.5	STH4DT / STH4DTSH
EPCSC2.5T	50	23 x 58 x 1.5	CSC2.5T/CSCG2.5T
EPCSC4T	50	28 x 65 x 1.5	CSC4T/CSCG4T
EPCSC6T	50	32 x 72 x 2	CSC6T/CSCG6T
EPCSC10T	50	37.5 x 75 x 1.5	CSC10T/CSCG10T
EPCSC16T	50	82 x 38 x 1.5	CSC16T/CSCG16T
EPCSCP2.5T(L&R)	25	27.5 x 35 x 5	CSCP2.5T/CSCP2.5T2
EPCSC2.5T1-2	50	27 x 74 x 1.5	CSC2.5T1-2
EPCSC2.5T2-2	50	25 x 90 x 1.5	CSC2.5T2-2/CSC2.5T/4(E)D3
EPCSC4T1-2	50	28.5 x 84.5 x 1.5	CSC4T1-2
EPCSC4T2-2	50	28.5 x 105 x 1.5	CSC4T2-2
EPCSC6T1-2	50	94 x 30 x 1.5	CSC6T1-2
EPAS2.5	50	35 x 54 x 1.5	AS2.5, 2.5/3, 2.5/4, AGT2.5, 2.5/3, 2.5/4
EPAS4	50	27.5 x 61 x 1.5	AS4, 4/3, 4/4, AGT4, 4/3, 4/4
EPAS6	50	33.5 x 74 x 1.5	AS6, 6/3, AGT6, 6/3
EPASF4	50	37 x 86 x 1.5	ASF4/ASF4L
EPADL2.5	50	43.5 x 80 x 1.5	ADL2.5/ADL2.5(E)D1/D2

**Isolation Partitions**

Isolation partitions provide separation between terminal blocks with different potentials. When used for DC power applications, voltages of up to ± 600V DC can be used on either side of the isolation partition. They also provide visual separation between groups of blocks.

- Material: polyamide 6.6
- Standard color: gray

**Separator Plates**

Used for electrical separation of adjacent jumpers. They can be inserted after the terminal blocks have been assembled on DIN rail. There is no loss of width.

**PARTITIONS**

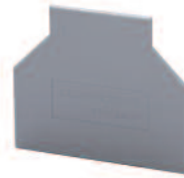

Cat. No.	Std. Pk.	Dimensions (H x L x W)	Suitable for:
PP2.5/4UN	50	37 x 44 x 1.6	CTS2.5UN/4UN/CTT2.5UK/T/J/E
PP6/10U	50	37.5 x 56.5 x 1.5	CTS6U/CTS10U
PP25U	50	46.5 x 62 x 1.5	CTS25U
PP25UN	50	42.5 x 62 x 1	CTS25UN
PP35U	50	50 x 64.5 x 1.5	CTS35U
PP35UN	50	50 x 64.5 x 1	CTS35UN
PPCMT4	50	32.5 x 37 x 1.6	CMT4/CMT4S/CMT4SU
PPCSFL4U	50	42.5 x 62 x 1.5	CSFL4U/4U(L)/CSDL4U
PPCSC2.5T	50	28 x 58.7 x 1.5	CSC2.5T/CSCG2.5T
PPCSC4T	50	33 x 65 x 1.5	CSC4T/CSCG4T
PPCSC6T	50	36.5 x 72 x 2	CSC6T/CSCG6T

**SEPARATOR PLATES**



Cat. No.	Std. Pk.	Dimensions (H x L x W)	Suitable for:
SP2.5/4UN	100	17.5 x 17.4 x 1.4	CTS2.5UN/4UN/CTT2.5UK/T/J/E
SP6/10U	100	15.4 x 16.2 x 1.5	CTS6U/CTS10U/16U
SPCDL4U	100	15.4 x 16.2 x 1.6	CDL4U/CDL4U(I.S)/ CDL4U(E) Series
SPCMB4	100	14.5 x 12 x 1.5	CMB4

**Protective Cover / Side Holding Plates**

For protection against dust and shock, transparent protective cover can be installed above the terminal block assembly with the aid of side/holding plates. The side holding plates can be fitted on 35 mm and 32 mm Din rails. These plates should be backed by standard end stops.

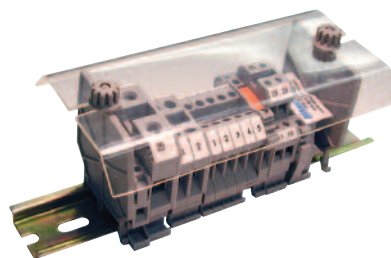

Assembled Block installed with Protective Cover

**CTSPC**

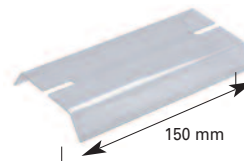

For all Rail Mounting Terminals

**CSP1**



Mounting Accessories for CTSPC

# Screw Clamp Terminal Block Accessories

## Jumpering System

The jumpering systems bus potentials between terminal blocks, reducing wiring time. Adjacent blocks or selective terminal blocks within an assembly can be easily interconnected, leaving terminal clamps free for wiring. Purchase complete assemblies, which are ready for installation, or select individual components to create custom or extra long jumpers. Jumper ampacity is lower than the rated current of the respective terminal blocks, therefore, applied current must not exceed the maximum current value of the block. Internal jumpers may be used in combination with external jumpers to achieve additional jumpering possibilities.

## Internal Jumper Assemblies

Internal Jumper Assemblies consist of a Current Bar, Shorting Sleeves and screws. They install easily into the center of the terminal block and connect to the current bar. They are available as standard 2, 3, 4 or 10 pole assemblies and are ready for immediate installation. Insulated internal jumpers provide shock protection when installed on terminal block assemblies.

## External Jumper

External Jumpers bus potentials between terminal blocks, reducing wiring time. Adjacent or selected blocks within an assembly can be easily interconnected. Jumper poles may be removed for selective jumpering. Jumpers are insulated and available in 2, 3, 4 and 10 pole versions. They are made of tin plated brass/copper.

## Current Bars

Current Bars are offered to create custom jumper assemblies for increased number of poles or custom jumpers. Select the current bar with the required number of poles, or field cut them to the required length. They are made of tin or nickel plated copper or brass.

## Shorting Sleeves & Screws

Shorting Sleeves & Screws ensure reliable and mechanically safe electrical connections between current bars and the terminal block current bars. One shorting sleeve is required for each jumpered terminal. They are made of nickel plated brass.

<sup>1</sup> Internal Jumpering System not available.

<sup>2</sup> 100 pole strip can be broken down to any number of poles desired.

### INTERNAL JUMPER



### INSULATED INTERNAL JUMPER



Terminal Series	Poles	Cat. No.	Torque	Std. Pk.	Cat. No.	Torque	Std. Pk.
CTS2.5UN	2	CA721/2	0.4 Nm	100	CA741/2	0.4 Nm	100
	3	CA721/3		100	CA741/3		100
	4	CA721/4		100	CA741/4		100
	10	CA721/10		10	CA741/10		10
	100 <sup>2</sup>	CA721/100		10	CA741/100		10
CTS4UN CMC1-2 CMC2-2 CTS4UTM CKT4U	2	CA722/2	0.4 Nm	100	CA742/2	0.4 Nm	100
	3	CA722/3		100	CA742/3		100
	4	CA722/4		100	CA742/4		100
	10	CA722/10		10	CA742/10		10
	100 <sup>2</sup>	CA722/100		10	CA742/100		10
	10 (breakable)						
CTS6U CDTTU <sup>1</sup> CDTTU-SH <sup>1</sup> CSDL6U <sup>1</sup> CSFL6U <sup>1</sup>	2	CA723/2	0.5 Nm	100	CA743/2	0.5 Nm	100
	3	CA723/3		50	CA743/3		50
	4	CA723/4		50	CA743/4		50
	100	CA723/10		10	CA743/10		10
CTS10U	2	CA724/2	0.5 Nm	100	CA744/2	0.5 Nm	100
	3	CA724/3		50	CA744/3		50
	4	CA724/4		50	CA744/4		50
	10	CA724/10		10	CA744/10		10
CTS16U	2	CA751/2	0.8 Nm	50	CA761/2	0.8 Nm	50
	3	CA751/3		50	CA761/3		50
	4	CA751/4		50	CA761/4		50
	10	CA751/10		10	CA761/10		10
CTS25U	2	CA725/2	0.8 Nm	50	CA745/2	0.8 Nm	50
	3	CA725/3		20	CA745/3		20
	4	CA725/4		20	CA745/4		20
	10	CA725/10		10	CA745/10		10
CTS35U	2	CA726/2	0.8 Nm	50	CA746/2	0.8 Nm	50
	3	CA726/3		20	CA746/3		20
	4	CA726/4		20	CA746/4		20
	10	CA726/10		10	CA746/10		10
CTS35UN*	2	CA771/2	0.8 NM	50	CA781/2	0.8 NM	50
	3	CA771/3		20	CA781/3		20
	4	CA771/4		20	CA781/4		20
	10	CA771/10		10	CA781/10		10
CMT4 CMT4S CMB4 CDL4U CDL4U(I.S) ODL4U CDL4UTM	2	CA727/2	0.4 Nm	100	CA747/2	0.4 Nm	100
	3	CA727/3		100	CA747/3		100
	4	CA727/4		100	CA747/4		100
	10	CA727/10		10	CA747/10		10
	100 <sup>2</sup>						
	10 (breakable)						
DDFL4U DDFL4U(E) DDDL4U CSFL4U <sup>1</sup> CSFL4U(L) <sup>1</sup> CSDL4U	2	CA729/2	0.5 Nm	100	CA749/2	0.5 Nm	100
	3	CA729/3		50	CA749/3		50
	4	CA729/4		50	CA749/4		50
	10	CA729/10		10	CA749/10		10
CAFL4U CAFL4U(L) <sup>1</sup>	2						
	3						
	4						
	10						
CTL2.5U CTL2.5UH CTL2.5UL CTL2.5UHL CTL2.5U(I.S)	2	CA722/2	0.4 Nm	100			
	3	CA722/3		50			
	4	CA722/4		50			
	10	CA722/10		20			
	100 <sup>2</sup>	CA722/100		20			
	10 (breakable)						

**EXTERNAL JUMPER**



**CURRENT BAR**



**SHORTING SLEEVE & SCREWS**



Cat. No.	Torque	Std. Pk.	Cat. No.	Std. Pk.	Cat. No.	Torque	Std. Pk.
CA717/2	0.4 Nm	100	CA703/01	100	CA707/S/Q/01	0.4 Nm	100
CA717/3		100	CA704/01	100			
CA717/4		100	CA705/01	100			
CA717/10		20	CA731/10	100			
			CA731/100	10			
CA713/2	0.5 Nm	100	CA703/1	100	CA707/S/Q/01	0.4 Nm	100
CA713/3		100	CA704/1	100			
CA713/4		100	CA705/1	100			
CA713/10		20	CA732/10	10			
			CA732/100	100			
CA710/2	0.8 Nm	100	CA703/2	100	CA707/S/Q/1	0.5 Nm	100
CA710/3		50	CA704/2	100			
CA710/4		50	CA705/2	100			
CA710/10		20	CA733/10	100			
CA718/2	0.8 Nm	100	CA703/3	100	CA707/S/Q/1	0.5 Nm	100
CA718/3		50	CA704/3	100			
CA718/4		50	CA705/3	100			
CA718/10		20	CA734/10	100			
			CA703/8	100	CA707/S/Q/5	0.8 Nm	100
			CA704/8	100			
			CA705/8	100			
			CA739/10	100			
			CA703/4	100	CA707/S/Q/2	0.8 Nm	100
			CA704/4	100			
			CA705/4	100			
			CA735/10	100			
			CA703/5	100	CA707/S/Q/2	0.8 Nm	100
			CA704/5	100			
			CA705/5	100			
			CA736/10	100			
			CA703/10	100	CA707/S/Q/2	0.8 Nm	100
			CA704/10	100			
			CA705/10	100			
			CA770/10	100			
CA714/2	0.5 Nm	100	CA703/1	100	CA707/S/Q	0.4 Nm	100
CA714/3		100	CA704/1	100			
CA714/4		100	CA705/1	100			
CA714/10		20	CA732/10	100			
			CA732/100	10			
			CA732/10-A	100			
CA711/2	0.8 Nm	100	CA703/6	100	CA707/S/Q/3	0.5 Nm	100
CA711/3		50	CA704/6	100			
CA711/4		50	CA705/6	100			
CA711/10		20	CA737/10	100			
CA716/2	0.8 Nm	50					
CA716/3		50					
CA716/4		50					
CA716/10		20					
CA715/2	0.4 Nm	100	CA703/1	100	CA707/S/Q/01	0.4 Nm	100
CA715/3		100	CA704/1	100			
CA715/4		100	CA705/1	100			
CA715/10		20	CA732/10	100			
			CA732/100	10			
			CA732/10-A	100			

# Spring Clamp Accessories



Terminal	Cat. No.	Std. Pk.	Cat. No.	Std. Pk.	Cat. No.	Std. Pk.
CSC2.5T	CA801/1-3	100	CA901/1	100	CA801/1	100
CSC4T	CA801/2-3	100	CA901/2	100	CA801/2	100
CSC6T	CA801/3-3	100	CA901/3	100	CA801/3	100
CSC10T					CA801/4	100
CSC2.5T1-2	CA801/1-3	100	CA901/1	100	CA801/1	100
CSC2.5T2-2	CA801/1-3	100	CA901/1	100	CA801/1	100
CSC4T1-2	CA801/2-3	100	CA901/2	100	CA801/2	100
CSC4T2-2	CA801/2-3	100	CA901/2	100	CA801/2	100
CSC6T1-2	CA801/3-3	100	CA901/3	100	CA801/3	100
CSCP2.5T					CA803/1	100
CSCP2.5T2					CA803/1	100
ADL2.5	CA801/1-3	100	CA901/1	100	CA801/1	100
ASF4					CA801/7	100

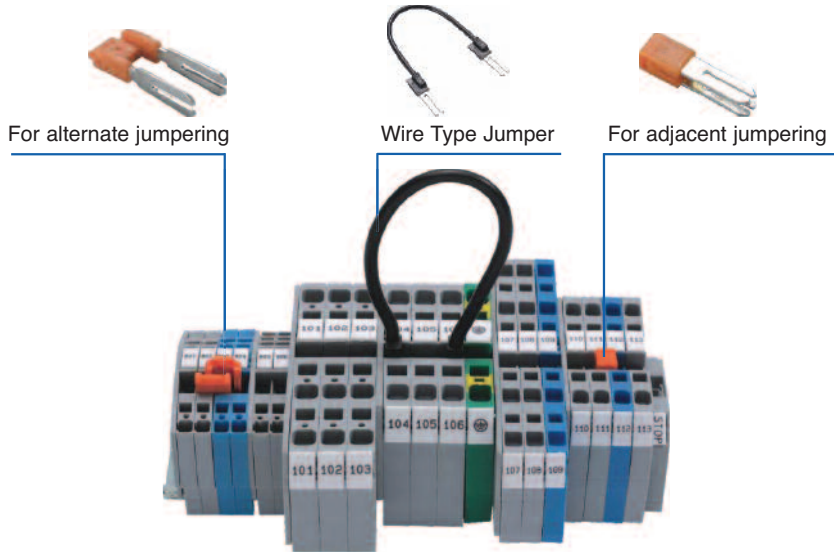

## Step Down Jumpers

Used for jumpering different size blocks.

Terminal	Cat. No.	Std. Pk.
CSC6T – CSC4T	CA901/4	100
CSC6T – CSC2.5T	CA901/5	100
CSC4T – CSC2.5T	CA901/6	100



**Marking Tags**

The cost effective MT marking system provides quick and accurate identification. MT Push-On Marking Tags fit all Altech DIN Rail mount and panel mount terminal blocks. They can be inserted individually or as strips of 10 tags on terminal block assemblies for quick and easy marking.

MT Marking Tags are supplied blank for custom marking or they can be ordered with a horizontal or vertical imprint. The standard tag color is white with black imprint. Tags can be ordered with up to 3 characters each. Imprints can be either consecutive or identical characters. MT tags, catalog numbers MT2-MT8 are supplied in packs of identical strips, 10 tags per strip. Catalog numbers MT10-MT15 are supplied in packs of identical strips, 5 tags per strip.

Group marker MTG1 is used for group identification and can be fixed on the end stop CA702.

When ordering specify strip marking as a suffix; i.e. MT2/H-1-10.

**Warning Labels**

These 5 position warning labels can be mounted on top of 8 mm Terminal Blocks. Besides giving visual identification, it also makes an entire DIN Rail Terminal Block assembly completely shock proof. SWL6 warning labels are suitable for CTS6U, CMDB6 and CDB6 series Terminal Blocks.

**BLANK MARKING TAGS**



Cat. No.	Std. Pk.		Dims	
	Strips	Tags	H	W
MT2	10	100	4.9	5.8
MT3	20	100	5.0	10.0
MT4	10	100	5.0	4.8
MT5	10	100	9.4	4.5
MT6	10	100	9.4	5.5
MT8	10	100	10.4	7.3
MT9	10	100	10.3	8.7
MT9F	10	10	10.3	90.0
MT10	20	100	10.4	9.4
MT12	20	100	10.4	11.3
MT15	20	100	10.4	14.3
MT20	20	100	4.9	20
MT25	20	100	4.9	25

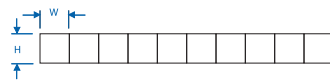

**HORIZONTAL MARKING TAGS**



Cat. No.	Std. Pk.		Dims	
	Strips	Tags	H	W
MT2/H	10	100	4.9	5.8
MT3/H	20	100	5.0	10.0
MT4/H	10	100	5.0	4.8
MT5/H	10	100	9.4	4.5
MT6/H	10	100	9.4	5.5
MT8/H	10	100	10.4	7.3
MT9/H	10	100	10.3	8.7
MT9F/H	10	10	10.3	90.0
MT10/H	20	100	10.4	9.4
MT12/H	20	100	10.4	11.3
MT15/H	20	100	10.4	14.3
MT20/H	20	100	4.9	20
MT25/H	20	100	4.9	25



Consecutive Digits  
(Specify decade)  
Nos. 1-10, 11-20, etc. up to 100 \*  
Nos. 101-110, etc. up to 999 \*



Identical Characters  
(Specify digits, characters)  
Nos. 1, 2, 3 etc. up to 999 \*  
Characters A, B. up to Z,  
Symbols +, -, ☺ \*

**VERTICAL MARKING TAGS**



Cat. No.	Std. Pk.		Dims	
	Strips	Tags	H	W
MT2/V	10	100	4.9	5.8
MT3/V	20	100	5.0	10.0
MT4/V	10	100	5.0	4.8
MT5/V	10	100	9.4	4.5
MT6/V	10	100	9.4	5.5
MT8/V	10	100	10.4	7.3
MT9/V	10	100	10.3	8.7
MT9F/V	10	10	10.3	90.0
MT10/V	20	100	10.4	9.4
MT12/V	20	100	10.4	11.3
MT15/V	20	100	10.4	14.3
MT20/V	20	100	4.9	20
MT25/V	20	100	4.9	25



Consecutive Digits  
(Specify decade)  
Nos. 1-10, 11-20, etc. up to 100 \*  
Nos. 101-110, etc. up to 999 \*



Group Marker, shown imprinted and attached to CA 702. Blank and custom printing available. Cat. No. MTG1

**SWL6**

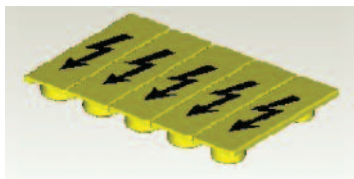

Material:  
Polyamide 6.6

Dimensions  
H x L x W:  
4 x 39.5 x 27 mm

Cat. No.	Std. Pk.
SWL6	50

Suitable for: All DIN Rails

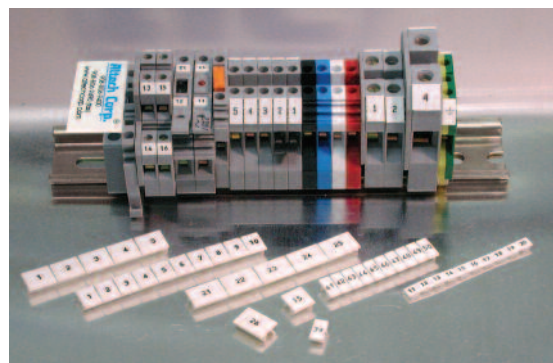

# The New and Affordable **Altech**® Marking Tag Plotter Package

For use with  
Altech & Connectwell  
Marking Tags Only

## CMPS 500 Plotter Package

- CMPS plotter
- Size: 17" x 18" x 4.9"
- Tag Sizes: MT2, MT3, MT4, MT5, MT6, MT8, MT9, MT10, MT12, MT15, MT20, MT25
- CMPS software with cable
- 2 fixtures for tags MT5-MT15 (MT9 sold separately)
- 1 fixture for tags MT2 and MT25
- 2 disposable pens

**Call  
today!**

Remember Altech  
also has the best priced  
blocks on the market.

# Altech Corp.®

908.806.9400 • [altechcorp.com](http://altechcorp.com)

**Scriber VS210**

The VS200 base unit is a stand-alone plotting system with an integral keyboard and display screen. The marker fixture, plotter pen, and the memory cassette have to be inserted in the base unit to make it operational. The base unit comes in an aluminum carrying case and includes the memory cassette and the power supply. A manual is available in English and Spanish.

The VS 200 can be used to produce labels of all types, with its fixture changeable in a matter of seconds.

The Vario VS 200 makes labeling easy. The menu-driven program guides you quickly and easily through all the steps.

It can be used at any time and in any place. Easily transported in its special case, the battery-operated (battery pack sold separately) VS 200 can be operated precisely where you need it. The spacious case provides enough room for the extensive accessories.

**Plotter VP 500**

The VP 500 base unit is an auxiliary plotter and has to be connected to a PC via a parallel port or USB connection. It is a high speed plotting device and enables plotting of different markers in one setting. The marker fixture and the plotter pen have to be inserted before commencing the plotting operation. The base unit is primarily controlled through a PC with the help of Vario Sign software. Manual available in English and Spanish.

The special design of the VP 500 enables it to hold different markers from various manufacturers at the same time. It is also possible to write on relatively large markers with a maximum height 14 mm.

**Fixtures**

Fixtures are required for alignment of markers with respect to the plotter pen. Different marker fixtures can be mounted on the plotter bed of the VP 500 at the same time thereby reducing set up times. Fixtures for different markers from various manufacturers like Altech, Allen Bradley, Connectwell, ContaClip, Entelec, Weidmuller, Phoenix Contact, PTR, Wieland, Wago, Murrplastik, Partex, SES Sterling, etc. are available. For more information on ordering fixtures please contact Altech.

**SCRIBER VS 210**



- Identifiers for connectors, wires, cables and equipment
- Cable ties, shrink tubing, labels and signs of different sizes and materials, as well as customer-specific items.
- Size: 14.9"x7.5"x1.77"
- Weight: 6.6 lbs.

**Ordering Information**

<b>BASE UNIT</b> (includes power supply, memory cassette and carrying case) .....	34000000
<b>STARTER KIT</b> (includes cleaning unit, pen cleaners, felt pen, 0.25 mm plotter pen) and ink cartridges .....	34000001
<b>FIXTURES</b> (Contact Altech for available manufactures) .....	3490xxxx
<b>MEMORY CASSETTE</b> .....	35500001
<b>BATTERY PACK</b> .....	35500000



**CMPS 500 PLOTTER PACKAGE**

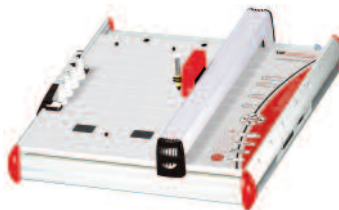

- CMPS plotter
- Size: 17"x18"x4.9"
- Tag Sizes: MT2, MT3, MT4, MT5, MT6, MT8, MT9, MT10, MT12, MT15, MT20, MT25
- CMPS software with cable
- 2 fixtures for tags MT5-MT15 (MT9 sold separately)
- 1 fixture for tags MT2 and MT25
- 2 disposable pens

**PLOTTER VP 500**

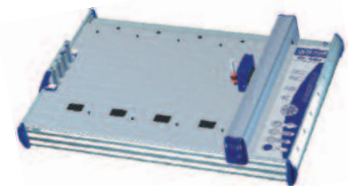

- Identifiers for connectors, wires, cables and equipment
- Cable ties, shrink tubing, labels and signs of different sizes and materials, as well as customer-specific items.
- Size: 26"x18"x4.9"

**Ordering Information**

<b>CMPS 500 PLOTTER PACKAGE</b> .....	34130008
<b>VP 500 BASE UNIT</b> (includes cable) .....	34000030
<b>STARTER KIT</b> (includes cleaning unit, pen cleaners, felt pen, 0.25 mm plotter pen) and ink cartridges .....	34000001
<b>VARIO SIGN SOFTWARE</b> .....	34000020
<b>SERVICE KIT</b> (includes 4 seal bonnets and 10 priming print cards) .....	34000026
<b>FIXTURES</b> (Contact Altech for available manufactures) .....	3490xxxx *

\* See page 85.

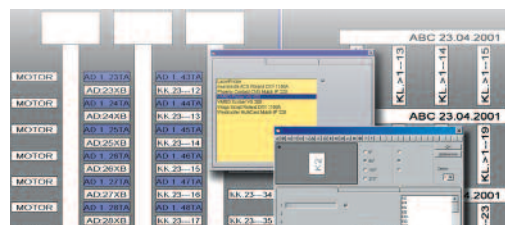
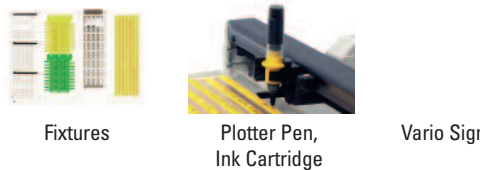



# Marking Systems

## Engraver VE500

The engraving unit was specifically **designed to be used with the VP500 and CMPS 500 plotters.** Changing back and forth between the pen-plotter and the engraver is easy. The engraver is meant to engrave plastic signs on double sided material, pre-cut or blank sheets, for legend plates, push button inlays, etc. The engraver is programmed by the VarioSign software for ease of use and design flexibility.



## Engraving Needles

These engraving needles are to be used with the VE500 engraver. They have a 15° angle and are available in 6 tip widths or as a complete set.

## Vacuum Cleaner Bag

Replacement bags for the VE500 engraver's vacuum cleaner

## ENGRAVER VE500



## Ordering Information

VE500 ENGRAVER UNIT (VP500 REQUIRED) .....34000040

## ENGRAVING NEEDLE



## Ordering Information

Product	Width	Order No.
Engraving Needle	0.20mm	35010003
Engraving Needle	0.30mm	35010002
Engraving Needle	0.40mm	35010001
Engraving Needle	0.50mm	35010000
Engraving Needle	0.70mm	35010004
Engraving Needle	1.00mm	35010005
Engraving Set(0.20, 0.30, 0.40, 0.50, 0.70, 1.00mm)		35010006
Engraving Needle(0.20 mm cutter stainless steel)		35012033

## VACUUM CLEANER BAG



## Ordering Information

VACUUM CLEANER BAG, SET OF 5 .....35020000

**Plotter Pens**

These “tubular-nib” pens are suitable for Vario Scriber VS 200, Vario Plotter VP 500 and all current labeling and identification systems with HP penholders. They are available in six tip widths identified by body color - 0.18 mm, 0.25 mm, 0.35 mm, 0.50 mm, 0.70 mm, and 1.00 mm; *ink cartridge not supplied with pen*. Special variants for other systems are available on request. Specially designed pre-filled felt-tip pens are available in a set of 4 colors (black, blue, red and green) and 2 sizes - 0.3 and 0.7 mm.



“tubular-nib” pens,  
6 sizes for black ink



**Ink Cartridges**

These are easy to insert “tubular-nib” pen cartridges containing special black ink suitable for marking, identifying and labeling various plastics. It is fast drying, smudge-proof, fade resistant, and resistant to chemicals when used on suitable plastic materials.



felt-tip pens,  
2 sizes, 4 colors

**Disposable Pens**

The disposable pens use the same special ink as used in the ink cartridges. They deliver the same outstanding durability and print quality as the standard plotter pens with the convenience of a disposable pen. These pre-filled pens allow for fast, efficient and cost effective printing without refilling ink or cleaning. They are available in two tip widths, 0.25 mm and 0.35 mm.



**Hand Pens**

The hand pens use the same special ink, as used in cartridges, and delivers the same outstanding durability and print quality. They are used for additional identification and special labeling tasks and are available in four tip widths of 0.25mm, 0.35mm, 0.50 mm, and 0.70 mm. No ink included. Must order part 35100006.



**Cleaning Unit**

It is an easy-to-use cleaning unit developed specially for EK Pens. The cleaning unit enables the pens to be rinsed thoroughly while preventing skin contact with cleaning fluid or ink. The cleaning unit can be used for up to ten cleaning cycles. The necessary precautions must be taken when disposing of cleaning fluid, the cleaning unit can be reused.



**Pen Cleaner**

This cleaning solution comes in easy to handle cartridges and is used in conjunction with the cleaning unit. A standard pack consists of two pen cleaner cartridges. Cleaning can be performed on standard refillable pens only.



**Adapter**

This adapter allows the user of Sharpie™ Ultra Fine felt tip pens instead of standard plotter pens.



Product	Width	Order No.
EK Plotter Pen	0.18 mm	35001018
EK Plotter Pen	0.25 mm	35001025
EK Plotter Pen	0.35 mm	35001035
EK Plotter Pen	0.50 mm	35001050
EK Plotter Pen	0.70 mm	35001070
EK Plotter Pen	1.00 mm	35001100

EK Ink Cartridge (5 pieces, Black, 1 ml. each)		35100006
---	--	----------

EK Felt-tip Pen-Set (white tip)	0.30 mm	35000005
EK Felt-tip Pen-Set (yellow tip)	0.70 mm	35000010

EK Disposable Plotter Pen	0.25 mm	35003025
EK Disposable Plotter Pen	0.35 mm	35003035

EK Hand Pen	0.25 mm	35002025
EK Hand Pen	0.35 mm	35002035
EK Hand Pen	0.50 mm	35002050
EK Hand Pen	0.70 mm	35002070

EK Cleaning Unit (empty)		35100009
--------------------------	--	----------

EK Pen Cleaner (2 pieces, 2x10 ml.)		35100008
EK Cleaning Set (includes cleaning unit and pen cleaner)		35100010

Adapter for an Ultra Fine Sharpie™		35000501
------------------------------------	--	----------

# Plotter Pen Handling and Care

## Handling and care of the EK-Team plotter pens for the universal EK-Team marking system.

For the state of the art universal marking system by EK-team, the manufacture is supplying a fast drying and etching ink that is required for marking plastic material within the control and automation industry. Due to these special properties of the ink, these plotter pens require much more care than a regular marking pen. Therefore EK-Team designed some helpful tools to keep your EK-team plotter pen in tip top shape.

### 1 Recovery and Storage Stand

This stand is designed to keep the plotter pen in an upright position, when not used with the marking system.

The upright position allows the plotter pen to recover and to be properly stored. It is recommended to store plotter pens that will be idle for a few hours in a dry and cool location, preferably in the refrigerator.

The recovery and storage stand accommodates easy storage and handling.

Call Altech for your free recovery and storage stand.

Cat. No. 35000100

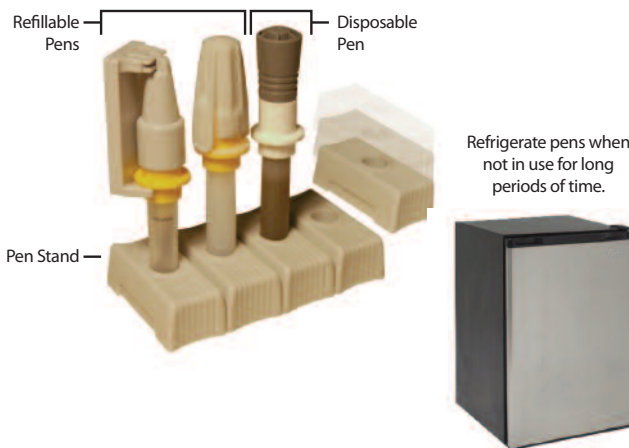

### 2 Suction Ball

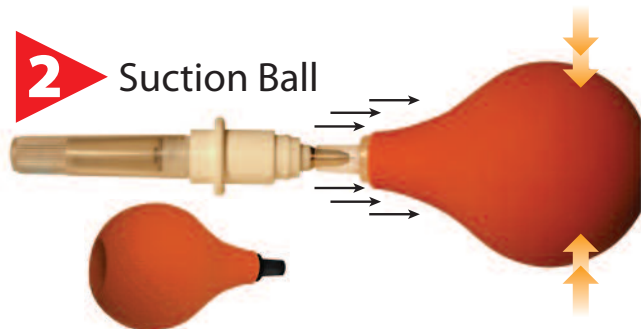

The "suction ball" is a helpful tool to bring a slightly clogged disposable or refillable plotter pen back to life.

The suction can unclog a slightly clogged plotter pen from the vacuum created within the "ball".

This additional tool can be very helpful in addition to the already available cleaning kit (Cat. No. 35100010) for the refillable plotter pens.

5 replacement tips are included with each suction ball.

Cat. No. 35100013

### 3 Pen Cleaning

#### CLEANING UNIT

It is an easy-to-use cleaning unit developed specially for refillable pens. The cleaning unit enables the pens to be rinsed thoroughly while preventing skin contact with cleaning fluid or ink. The cleaning unit can be used for up to ten cleaning cycles. The necessary precautions must be taken when disposing of cleaning fluid, the cleaning unit can be reused.

#### PEN CLEANER

This cleaning solution comes in easy to handle cartridges and is used in conjunction with the cleaning unit. A standard pack consists of two pen cleaner cartridges. Cleaning can be performed on standard refillable pens only.

Cleaning Set Cat. No. 35100010



Description	Part No.
<b>Altech</b>	
Altech MT 2n - MT 4n, MT 7.5, MT 20, MT 25	34902081
Altech MT 5 - MT 15	34902001
Altech Group marker G1, G2, G4	34902080
<b>ABB / Entrelec</b>	
ABB Entrelec universal - RC/RCT quarter size	34902063
ABB Entrelec RC 510A, 610A, 810A	34902114
ABB Entrelec RC 510B, 610B, 810B"	34902102
ABB Entrelec RB-RBP 5-12	34902086
ABB Entrelec BA 5-50	34902100
ABB Entrelec PIB	34902101
ABB Entrelec RCCV	34902038
ABB Entrelec BS / ILS / ILS-H	34902106
Set of sticky pads ( 8 pcs) for RC/RCT	34910000
<b>Allen Bradley / Woertz</b>	
Allen Bradley Universal W4 SERIES OLD AB WORTZ & S.S.	34902046
Weidmüller / Rockwell (Allen Bradley)	
Weidmüller MultiCard Universal (M5X8)	34902045
Weidmüller MultiCard SF4-6	34902044
Set of sticky pads (6 pcs) for Multicard Universal	34910001
<b>Conta Clip</b>	
SB5, SB6 BSTR10.12	34902002
SB8/10	34902003
<b>Phoenix</b>	
Phoenix Contact ZBM	34902039
Phoenix Contact ZB	34902047
Phoenix Contact ZBFM	34902049
Phoenix Contact ZBF, ZBN	34900050
Phoenix Contact BNZ	34902051
Phoenix Contact BN-ZB	34902052
Phoenix Contact SS-ZB	34902053
Phoenix Contact LBHZ	34902054
Phoenix Contact PAB	34902055
Phoenix Contact GPE	34902071
Phoenix Contact GPE	34902106
<b>Wago</b>	
WAGO WMB 4/4,2/5	34902041
WAGO WSB 4	34902074
WAGO WSB 5/5,2	34902075
WAGO WSB mini	34902076
WAGO Group marker carrier	34902078
WAGO Marking Strip	34902087
WAGO Marker tags	34902094
WAGO WTB	34902096
WAGO WCB	34902097
WAGO WMB inline	34902098
WAGO 210-345	34902106
Set of sticky pads (12 pcs) for Top Job (Marking Strip)	34910002
<b>Weidmüller / Rockwell (Allen Bradley)</b>	
Weidmüller MultiCard Universal	34902045
Weidmüller MultiCard SF4-6	34902044
Set of sticky pads (6 pcs) for Multicard Universal	34910001
<b>Wieland</b>	
Wieland Universal	34902043
Wieland BZ/WKF 1,5 04.243.2053.0	34902047
Wieland BZ/WKF 1,5/10 Z4.243.2053.0	34902049
Wieland Steierform 6 x 15, 10 x 20	34902106

## VE500 and CMPS 500 Engraving Fixtures

<b>EK-TEAM</b>	
Universal engraving and plot support plate half size (A4)	34902106
Universal engraving and plot support plate full size (A3)	34902107
Universal engraving and plot support plate 30x100 ninefold	34902115
Universal engraving and plot support plate 60x100 fourfold	34902116
Universal engraving and plot support plate 90x100 threefold	34902117

**CUSTOM FIXTURES AND OTHER MANUFACTURERES ARE AVAILABLE**  
**Contact Altech for Pricing (not in Price Book)**

# PCB Mounting Tracks

Mount standard or custom printed circuit boards in Mounting Tracks which can be conveniently DIN rail or panel mounted in your control panel or cabinet. These are the same tracks used for Altech interface modules. We now make them available to you to house and protect your custom boards, etc. Tracks are easily cut to size or can be ordered pre-cut to specific lengths. They are easily assembled from standard components and snap onto 35mm DIN rail or can be panel mounted.

Each track has two sets of printed circuit board guides to accept two alternate board widths.

End Sections hold printed circuit boards securely in place and keep out foreign objects.

## MOUNTING

When mounting extrusions on DIN rail, order two or more DIN Rail mounting feet. These feet slide into grooves on the extrusion. Then attach two DIN Rail Mount End Sections with help of EPS screws.

To panel mount, order two Panel Mount End Sections (and EPS screws), each with an integral mounting flange with a 6 x 8mm (.24 x .32 in.) hole slot.

If desired, tracks can be direct mounted using double sided tape. Order two DIN rail mount end sections (and EPS screws).

- Standard Lengths: 1m (3'-3") or 2m (6'-6")
- Track Material: PVC
- Temperature Limit:  
Short Term - 80°C (176°F)  
Continuous - 70°C (158°F)
- End Section, Foot Material: Polyamide
- Preassembled, Precut Lengths Available
- Tracks Accept Standard MT2 Marking Tags

\* Green color available on request.  
Contact Altech for more information.

## Narrow Mounting Track Extrusion and Components

For PC Board Widths 73mm (2.9 in.)

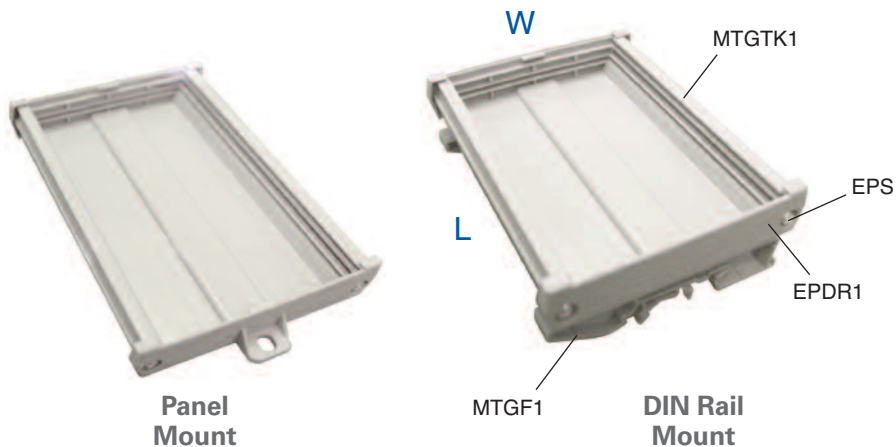

	Cat. No.	Std. Pk.
Mounting Track		
1 meter, grey	MTGTK1/1M	5
2 meter, grey	MTGTK1	5
1 meter, green*	MTGTK1/1M/G	5
2 meter, green*	MTGTK1/G	5
Accessories		
DIN Rail Mount End Section, grey	EPDR1	100
DIN Rail Mount End Section, green*	EPDR1/G	100
DIN Rail Mounting Foot, grey	MTGF1	100
DIN Rail Mounting Foot, green*	MTGF1/G	100
Panel Mount End Section, grey	EPDP1	100
Panel Mount End Section, green*	EPDP1/G	100
DIN Rail / Panel Mount End Section Screws #4x1/2", Phillips Pan head (2 required per end section)	EPS	200
Marking Tags	MT2	100
DIN Rail Mounting Kit (2x EPDR, 2x MTGF, 4x EPS)	1.100	1

## Sizing Information

Printed Circuit Board Width	
Track Type	High Guide (HG)
MTGTK1	73 ± 1mm (2.9 ± 0.05 in.)
MTGTK2	110 ± 1mm (4.3 ± 0.05 in.)

Mounting Track Extrusion "Cut-to-Size" Formula
Extrusion Length = Printed Circuit Board Length - 4.5mm (.175 in.)

**Wide Mounting Track  
Extrusion and Components**

For PC Board Widths 110mm (4.9 in.)



**Narrow Mounting Track**

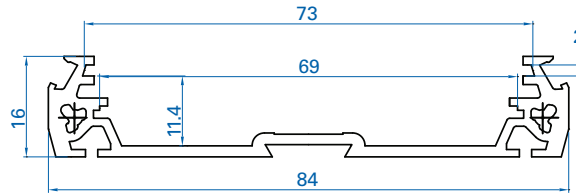

PCB MOUNTING TRACK (73 mm)

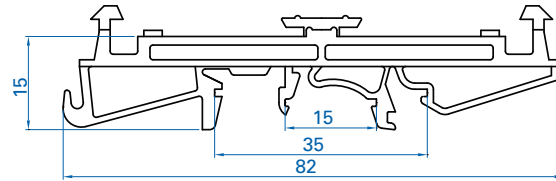

DIN RAIL MOUNTING FOOT (73mm)

**Wide Mounting Track**

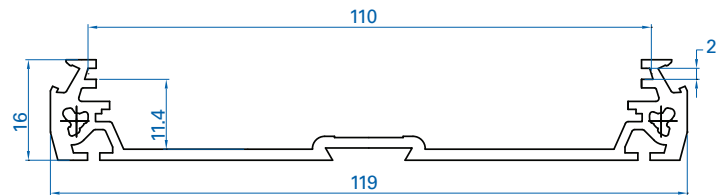

PCB MOUNTING TRACK (110 mm)

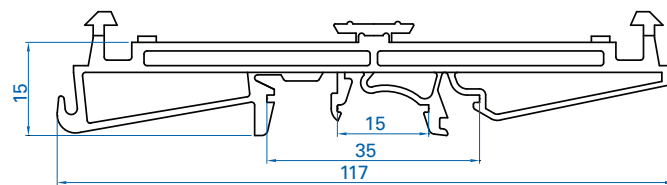

DIN RAIL MOUNTING FOOT (110mm)

Cat. No.	Std. Pk.
MTGTK2/1M	5
MTGTK2	5
MTGTK2/1M/G	5
MTGTK2/G	5
EPDR2	100
EPDR2/G	100
MTGF2	100
MTGF2/G	100
EPDP2	100
EPDP2/G	100
EPS	200
MT2	100

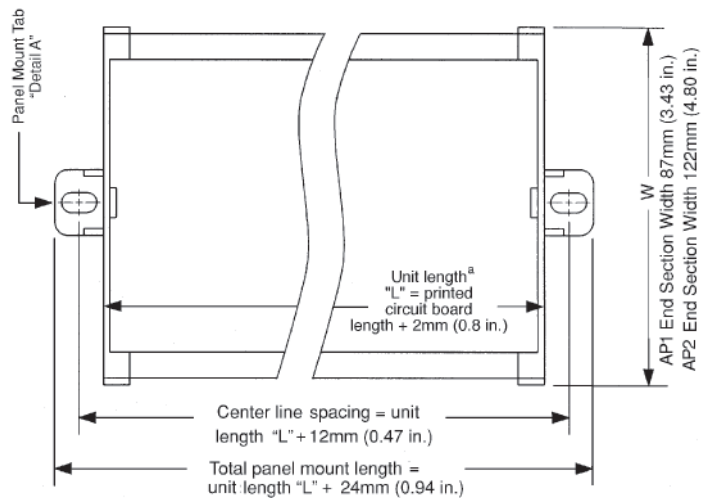
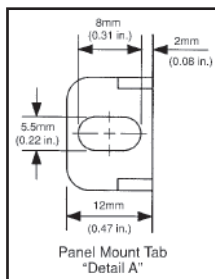

<sup>a</sup>Also applies for DIN Rail Mount Unit

# Receptacles

## Features:

- DIN Rail, Panel Mount or Wall Mount
- Rating: 15A/125V AC
- Finger Protection: IP54
- Available in 3 colors.

### PANEL MOUNT





### WALL MOUNT



### DIN RAIL MOUNT



External Dimension (HxWxL mm)	36.5 x 61.5 x 50	50 x 71 x 53.5	58.5 x 84 x 53.5
Stripping Length	10 mm	10 mm	10 mm
Insulation Material	Thermoplastic	Thermoplastic	Thermoplastic
Type of Connection	3 screw clamps	3 screw clamps	3 screw clamps
Approvals*	 E154664	 E154664	 E154664
Voltage Rating	125 V	125 V	125 V
Current Rating	15 A	15 A	15 A

Cat. No. Std. Pk.

Cat. No. Std. Pk.

Cat. No. Std. Pk.

## Complete Kit:

Blue	PMRBU	1	WMRBU	1	DMRBU	1
Gray	PMRGR	1	WMRGR	1	DMRGR	1
Black	PMRBA	1	WMRBA	1	DMRBA	1
Optional Accessory Sealing Gasket	SEALGASK	1	SEALGASK	1	SEALGASK	1

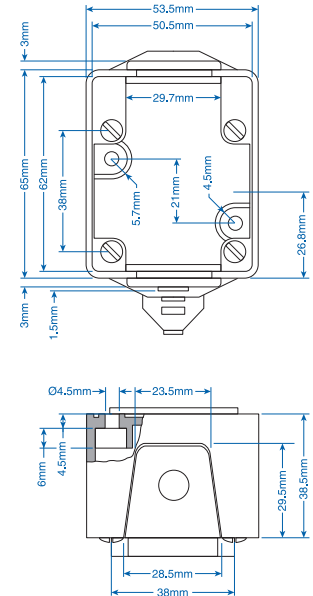
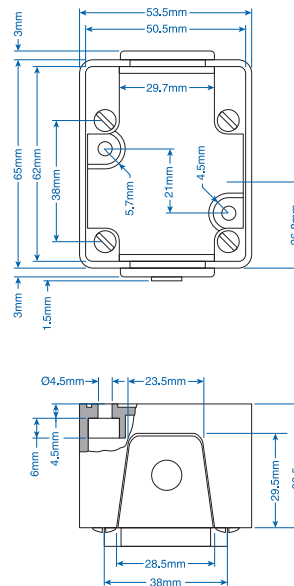
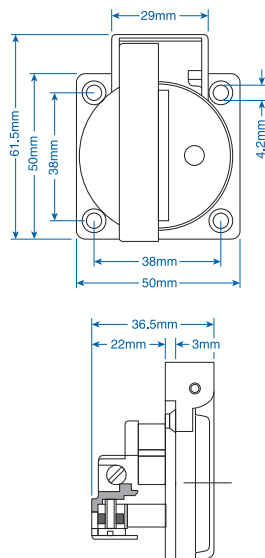

<sup>a</sup>Also applies for DIN Rail Mount Unit

**PANEL MOUNT**

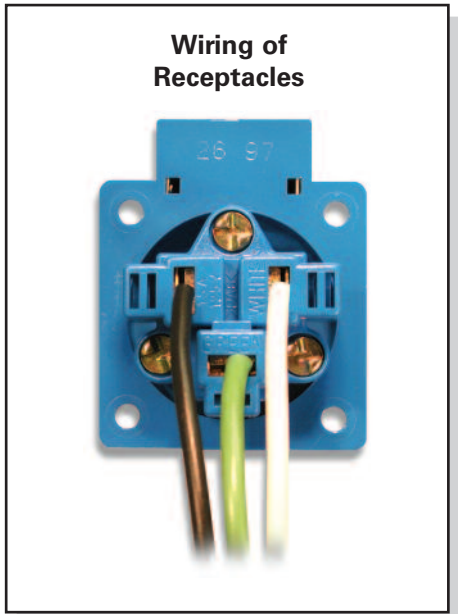
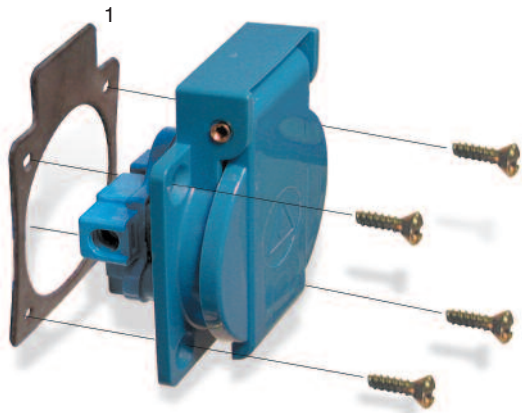

**WALL MOUNT**

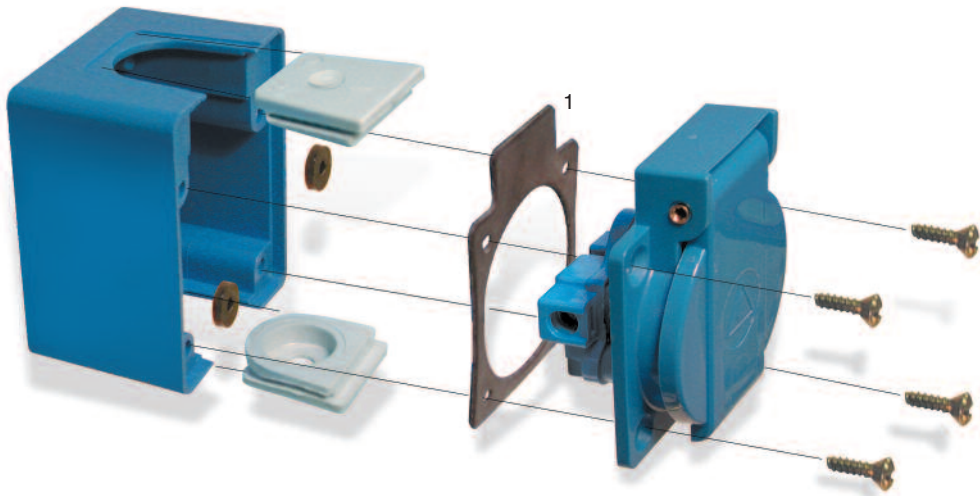

**DIN RAIL MOUNT**

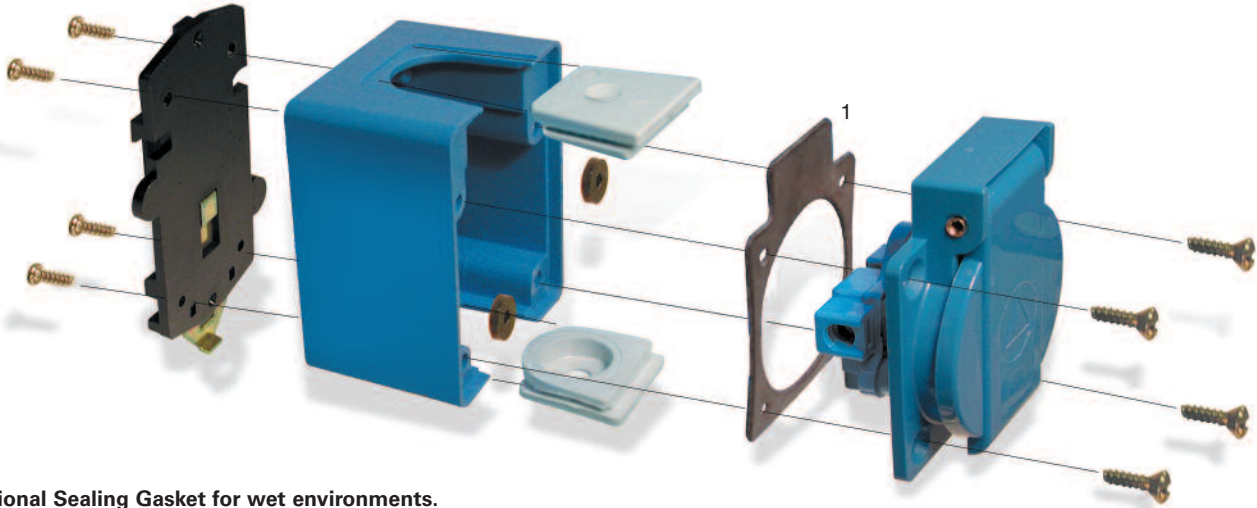

<sup>1</sup> Optional Sealing Gasket for wet environments.