

TK 1818 – Polystyrene and Polycarbonate – 182x180mm (7.17x7.09in.)

Standard Features

- **Protection Level:** IP66 (NEMA Type: 4X with gray cover, 12K with transparent cover)
- **Technical:** Smooth or Knockout Sidewalls
Gray or Tinted Transparent Cover
Multiple Enclosure Mounting Options
- **Enclosure Material:** Polystyrene or Polycarbonate
- **Gasket Material:** Polyurethane
- **Color:** Light Gray
- **Temperature Range:** Polystyrene
-40°C to 70°C (-40°F to 158°F)
Polycarbonate
-35°C to 120°C (-31°F to 248°F)
- **Accessories:** See section below



Smooth Sidewalls

Ordering Information	Height mm (in)	Polystyrene				Polycarbonate ¹			
		Cat. No.	Type	Cover Color	Std. Pk.	Cat. No.	Type	Cover Color	Std. Pk.
Enclosure - low cover	90 mm (3.54 in)	110-407	PS 1818-9-o	gray	2	120-407	PC 1818-9-o	gray	2
Enclosure - high cover	111 mm (4.37 in)	110-907	PS 1818-11-o	gray	2	120-907	PC 1818-11-o	gray	2
Enclosure - top hat cover	165 mm (6.50 in)	109-407	PS 1818-16-o	gray	1	121-407	PC 1818-16-o	gray	1
Enclosure - low cover	90 mm (3.54 in)	111-007	PS 1818-9-to	trans.	2	130-007	PC 1818-9-to	trans.	2
Enclosure - high cover	111 mm (4.37 in)	111-507	PS 1818-11-to	trans.	2	130-507	PC 1818-11-to	trans.	2
Enclosure - top hat cover	165 mm (6.50 in)	112-007	PS 1818-16-to	trans.	1	131-007	PC 1818-16-to	trans.	1

Sidewalls with Metric Knockouts

Ordering Information	Height mm (in)	Polystyrene				Polycarbonate ¹			
		Cat. No.	Type	Cover Color	Std. Pk.	Cat. No.	Type	Cover Color	Std. Pk.
Enclosure - low cover	90 mm (3.54 in)	105-407	PS 1818-9-m	gray	2	127-407	PC 1818-9-m	gray	2
Enclosure - high cover	111 mm (4.37 in)	105-907	PS 1818-11-m	gray	2	127-907	PC 1818-11-m	gray	2
Enclosure - top hat cover	165 mm (6.50 in)	104-407	PS 1818-16-m	gray	1	128-407	PC 1818-16-m	gray	1
Enclosure - low cover	90 mm (3.54 in)	106-007	PS 1818-9-tm	trans.	2	137-007	PC 1818-9-tm	trans.	2
Enclosure - high cover	111 mm (4.37 in)	106-507	PS 1818-11-tm	trans.	2	137-507	PC 1818-11-tm	trans.	2
Enclosure - top hat cover	165 mm (6.50 in)	107-007	PS 1818-16-tm	trans.	1	138-007	PC 1818-16-tm	trans.	1

Accessories

Ordering Information	Cat. No.	Type	Std. Pk.
Mounting Plate	195-007	MP1818	1
DIN Rail TS35-144mm	198-144	TS 35/144	1
Hinge Kit Set	190-005	HK2	1
Mounting Tab Kit	194-001	MT1	1

Please refer to pages 116-120 for additional accessories and detailed information.

Dimensions

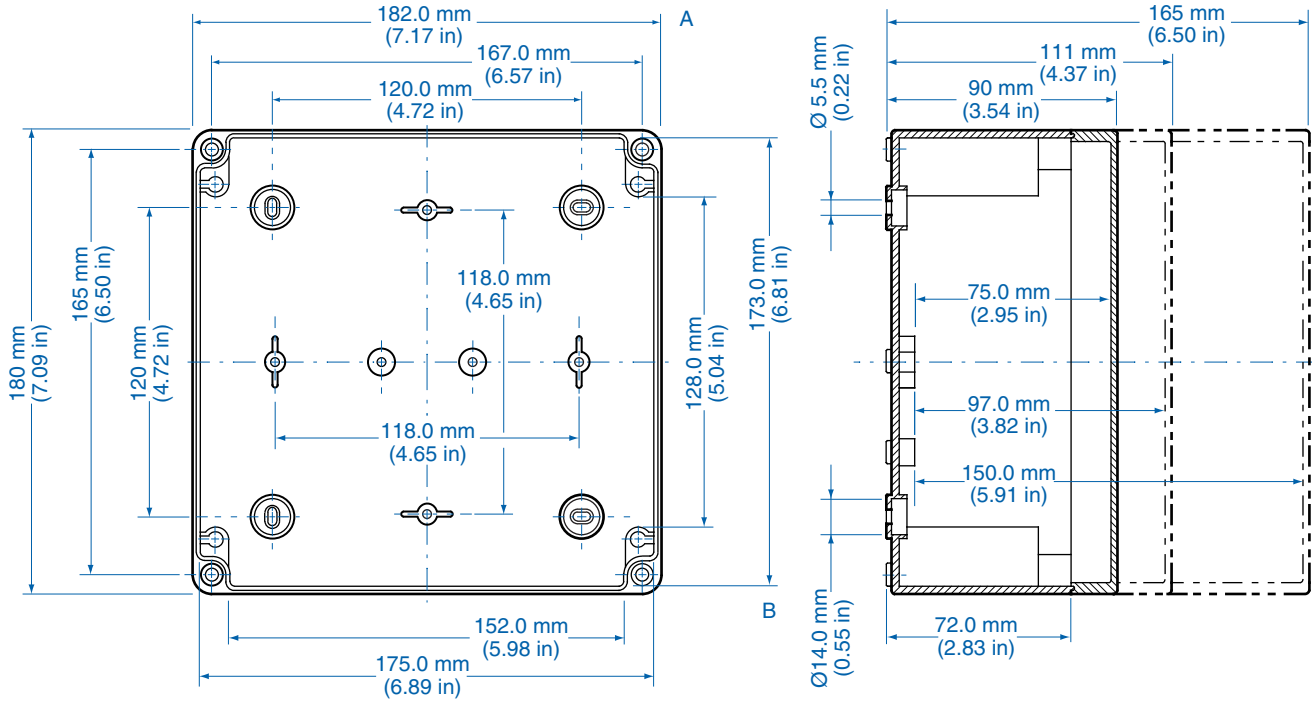

Knockout Positions

Side A

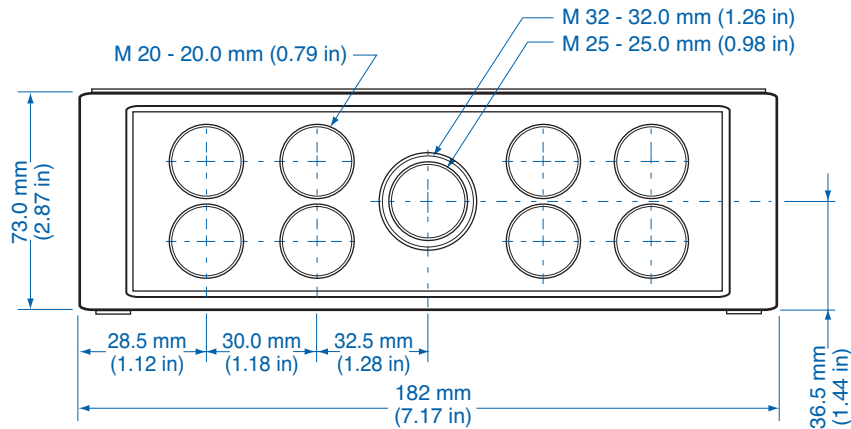

Side B

